

- 3 digit display
- Choice of 4 ventilation stages or 3 ventilation stages and 1 heating stage
- Minimum ventilation cycle on timer
- Pilot lights indicate the status of outputs
- Cover is fastened to case by means of quarter turn screws which allow quick access to internal adjustments
- Overload protection on outputs by means of fuses

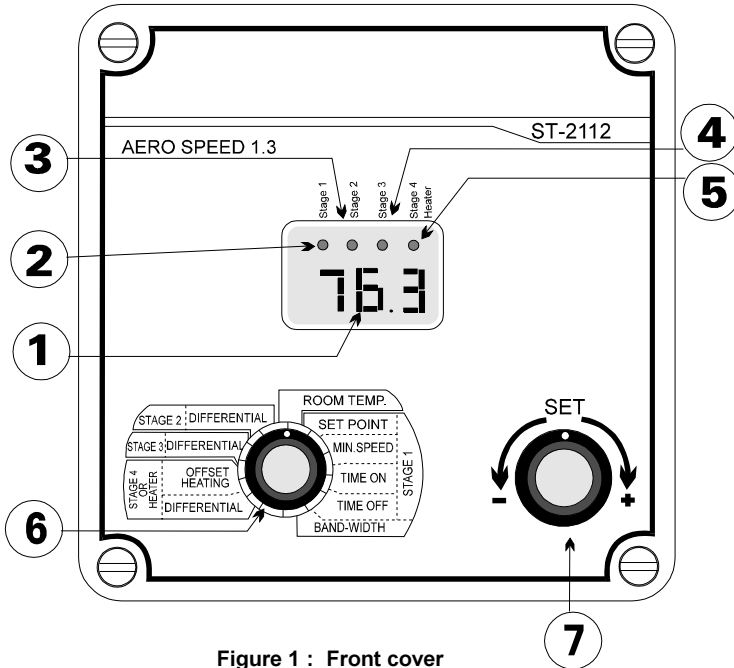

Figure 1 : Front cover

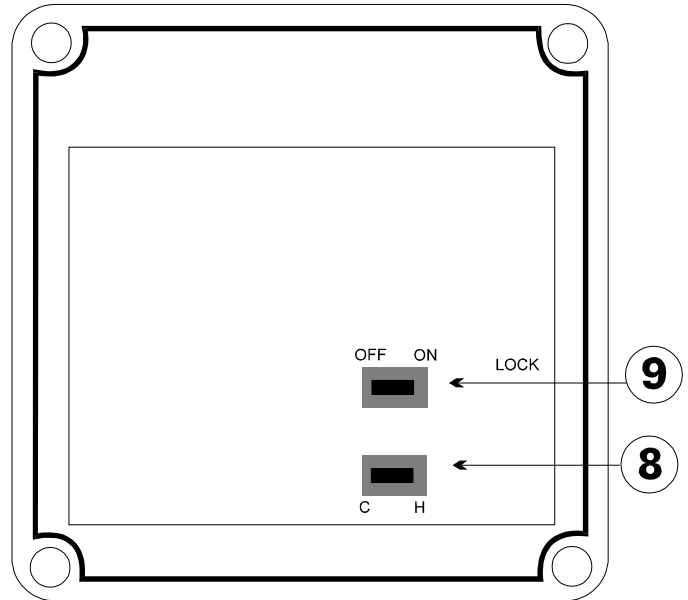
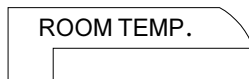

Figure 2 : Internal circuit

- 1- Digital display (3 digits)**
Displays the room temperature and other parameters shown around selection knob 6.
- 2- Pilot light for stage 1**
Illuminates when stage 1 fan is in operation.
- 3- Pilot light for stage 2**
Illuminates when stage 2 fan is in operation.
- 4- Pilot light for stage 3**
Illuminates when stage 3 fan is in operation.
- 5- Pilot light for stage 4 fan or heater**
Illuminates when stage 4 (fan or heater) is in operation.
- 6- Parameter selection knob**
Use this knob to select the parameter that is to be adjusted.
- 7- Set knob**
Use this knob to increase or decrease the value of the parameter being adjusted.
- 8- Selector switch for stage 4 operating mode**
C position : stage 4 operates in ventilation mode
H position : stage 4 operates in heating mode
- 9- Locked mode switch**
The controller is in locked mode when the locked switch is at ON. In the locked mode, only the **TEMPERATURE SET POINT** can be modified. All other parameters cannot be modified, though they may be visualized on the display.

OPERATION



ROOM TEMPERATURE

Use this position to visualize the room temperature as well as the minimum and maximum temperatures recorded since their last reset. Note that when the display is not flashing, the value appearing on the display represents the room temperature. When the display is flashing, the value appearing on the display represents either the minimum temperature or the maximum temperature.

TO VISUALIZE THE MINIMUM AND MAXIMUM ROOM TEMPERATURES

- Set knob 6 at ROOM and turn knob 7 clockwise by one notch. The minimum temperature will then be displayed. Turn knob 7 clockwise one notch further and the maximum temperature will then be displayed. If knob 7 is turned counterclockwise rather than clockwise, the display sequence will be reversed (room, maximum, minimum, room...).

TO RESET THE MINIMUM AND MAXIMUM TEMPERATURES

- Set knob 6 to ROOM TEMPERATURE and turn knob 7 clockwise or counterclockwise as described above to display either the minimum temperature or the maximum temperature. The display will then be flashing. Leave knob 7 in this position. After 10 seconds, the minimum and maximum temperatures will be reset and the room temperature will be displayed.

CAUTION
 In order to avoid resetting the minimum and maximum temperatures while visualizing them, return to the room display within 10 seconds using knob 7.

TEMPERATURE SET POINT

- Set knob 6 to this position and use knob 7 to select the required room temperature. The temperature set point can be adjusted between 35.0° and 99.9°F.

PARAMETERS FOR STAGE 1

MINIMUM SPEED : Set knob 6 to this position and use knob 7 to select the required minimum speed for stage 1. The minimum speed can be adjusted between 0 and 100%.

BAND-WIDTH : Set knob 6 to this position and use knob 7 to select the required temperature band-width. The band-width can be adjusted between 0.5° and 20.0°F.

MINIMUM VENTILATION CYCLE : Minimum ventilation is related to room temperatures lower than set point where a minimum amount of air is still required to avoid accumulation of moisture and toxic gas.

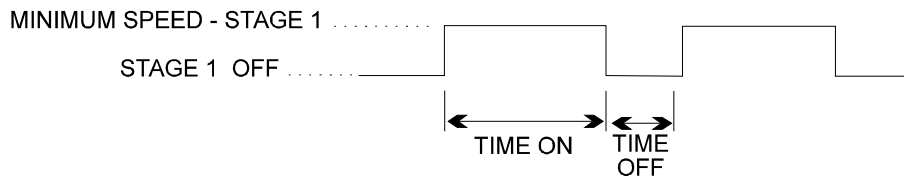
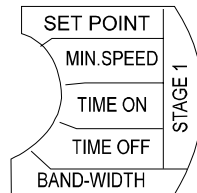

- The minimum ventilation cycle only applies to stage 1. During ON TIME, the fan operates at MINIMUM SPEED rather than maximum speed.
- The minimum ventilation cycle is useful to ensure a permanent air change in the room and to prevent fans from freezing in wintertime.
- To adjust the ON TIME, set knob 6 at TIME ON and use knob 7 to select the required ON TIME. The ON TIME is displayed in seconds and can be adjusted between 0 and 900 seconds.
- To adjust the OFF TIME, set knob 6 at TIME OFF and use knob 7 to select the required OFF TIME. The OFF TIME is displayed in seconds and can be adjusted between 0 and 900 seconds.
- For the fan to operate continuously at minimum speed, set the OFF TIME at 0 and set the ON TIME at any value other than 0.
- For the fan to stop operating rather than operate in the MINIMUM VENTILATION CYCLE, set the ON TIME at 0.
- If the ON TIME and the OFF TIME are both set at 0, the fan will stop operating rather than operate in the MINIMUM VENTILATION CYCLE.

PARAMETERS FOR STAGE 2

DIFFERENTIAL : Set knob 6 to this position and use knob 7 to set the desired temperature differential. The differential can be adjusted between 0.5° and 20.0°F.

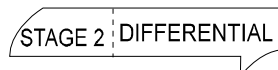

PARAMETERS FOR STAGE 3

DIFFERENTIAL : Set knob 6 to this position and use knob 7 to set the desired temperature differential. The differential can be adjusted between 0.5° and 20.0°F.



PARAMETERS FOR STAGE 4 OR HEATER

DIFFERENTIAL : Set knob 6 to this position and use knob 7 to select the required temperature differential. The differential can be adjusted between 0.5° and 20.0°F.

OFFSET HEATER : Set knob 6 to this position and use knob 7 to select the required **OFFSET HEATER**. This parameter is used only in heating mode (switch 8 set at H). **OFFSET HEATER** can be adjusted between 0.5° and 20.0°F.

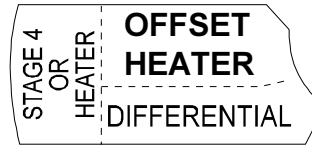

When Stage 4 is in the cooling mode (switch 8 set at C), as shown in figure 3 below :

- The controller changes from minimum ventilation cycle on timer to full time minimum speed when **ROOM TEMPERATURE = SET POINT** and returns to minimum ventilation when **ROOM TEMPERATURE = SET POINT - 1°F**.
- The controller remains in stage 1 at **MINIMUM SPEED** when the room temperature is within the 1°F margin preceding the minimum ventilation cycle.
- Stage 1 starts at **MINIMUM SPEED** when **ROOM TEMPERATURE = SET POINT** and reaches its maximum speed when **ROOM TEMPERATURE = SET POINT + BAND-WIDTH 1**.

- Stage 2 is activated at its maximum speed when **ROOM TEMPERATURE = SET POINT + BAND-WIDTH 1 + DIFFERENTIAL 2** and is stopped when **ROOM TEMPERATURE = SET POINT + BAND-WIDTH 1 + DIFFERENTIAL 2 + 1.5°F**.
- Stage 3 is activated at its maximum speed when **ROOM TEMPERATURE = SET POINT + BAND-WIDTH 1 + DIFFERENTIAL 2 + DIFFERENTIAL 3** and is stopped when **ROOM TEMPERATURE = SET POINT + BAND-WIDTH 1 + DIFFERENTIAL 2 + DIFFERENTIAL 3 + 1.5°F**.
- Stage 4 is activated at its maximum speed when **ROOM TEMPERATURE = SET POINT + BAND-WIDTH 1 + DIFFERENTIAL 2 + DIFFERENTIAL 3 + DIFFERENTIAL 4** and is stopped when **ROOM TEMPERATURE = SET POINT + BAND-WIDTH 1 + DIFFERENTIAL 2 + DIFFERENTIAL 3 + DIFFERENTIAL 4 + 1.5°F**.

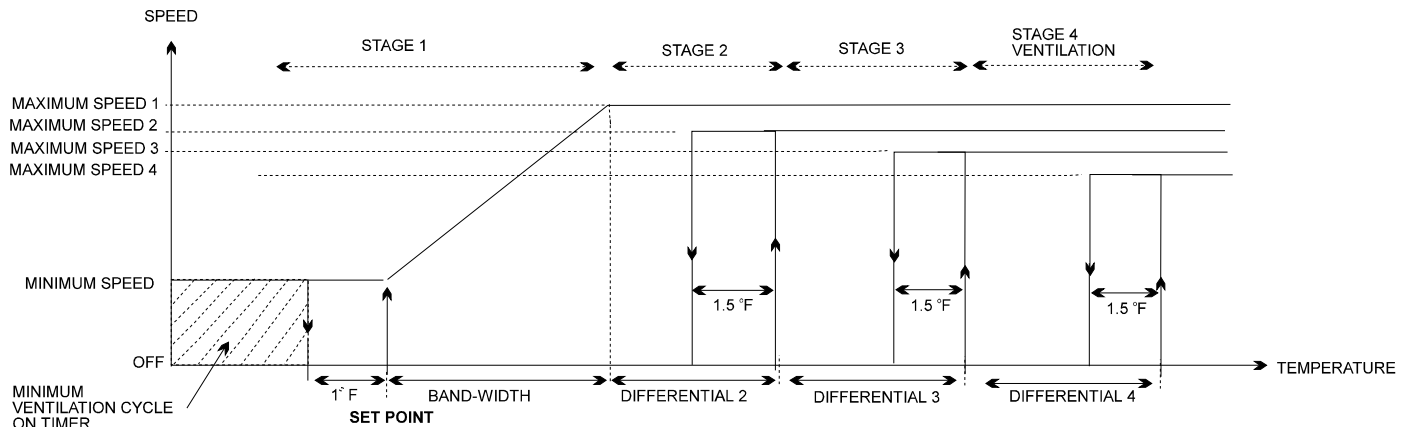

Figure 3 : Operation of temperature parameters when stage 4 is in the COOL mode

When stage 4 is in the heating mode (switch 8 set at H), as shown in figure 4 below :

- The operation of stages 1, 2 and 3 is as described for the cooling mode.
- Heating is activated when **ROOM TEMPERATURE = SET POINT - OFFSET HEATER - DIFFERENTIAL 4** and is stopped when **ROOM TEMPERATURE = SET POINT - OFFSET HEATER**.

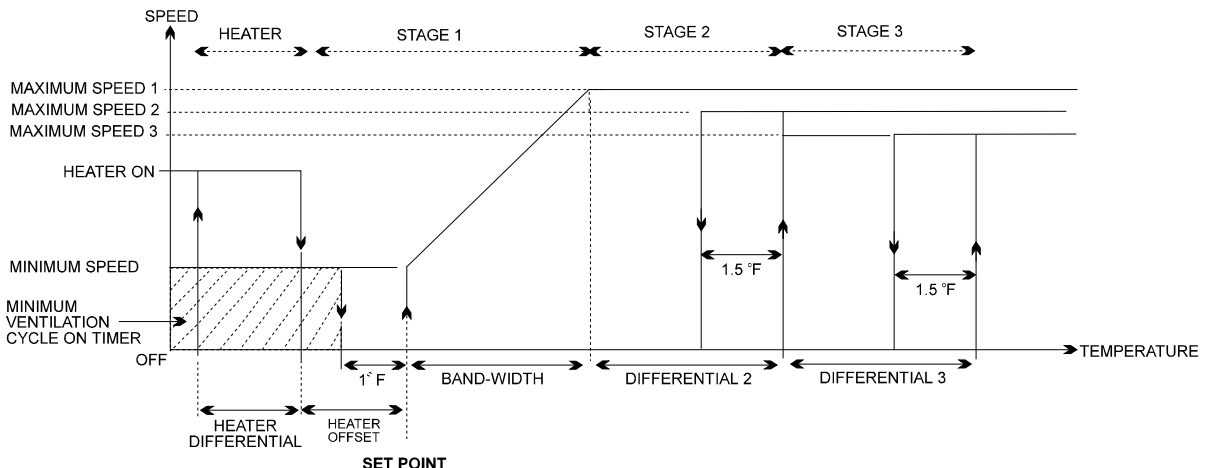

Figure 4 : Operation of temperature parameters when stage 4 is in the HEAT mode

INSTALLATION

- Place the required number of cable holders in the provided holes at the bottom of the controller. If the controller is installed in a dusty or humid environment, use watertight cable holders.
- The room temperature where the controller is installed **MUST ALWAYS REMAIN BETWEEN 0° AND 40°C (32° AND 104°F)**.
- Mount the controller on the wall with screws through the mounting holes located at the back of the case.
- **FASTEN THE SUPPLIED BLACK CAPS ON EACH OF THE MOUNTING HOLES.**

WIRING

- For typical hook-up, refer to figure 5.

CAUTION

DISCONNECT THE POWER SUPPLY BEFORE MAKING WIRING CONNECTIONS TO PREVENT ELECTRICAL SHOCK AND EQUIPMENT DAMAGE.

ALL WIRING MUST COMPLY WITH APPLICABLE CODES, ORDINANCES AND REGULATIONS.

INSTALLATION MUST BE DONE BY AN AUTHORIZED ELECTRICIAN.

USE OF EXTERNAL RELAYS MAY BE REQUIRED ON ON-OFF STAGES.

Set the line voltage selector according to the line voltage being used.

If metal cable holders are used to secure cables entering the ST-2112 case, use the furnished ground plate. The ground wire must be connected to the screw on the ground plate.

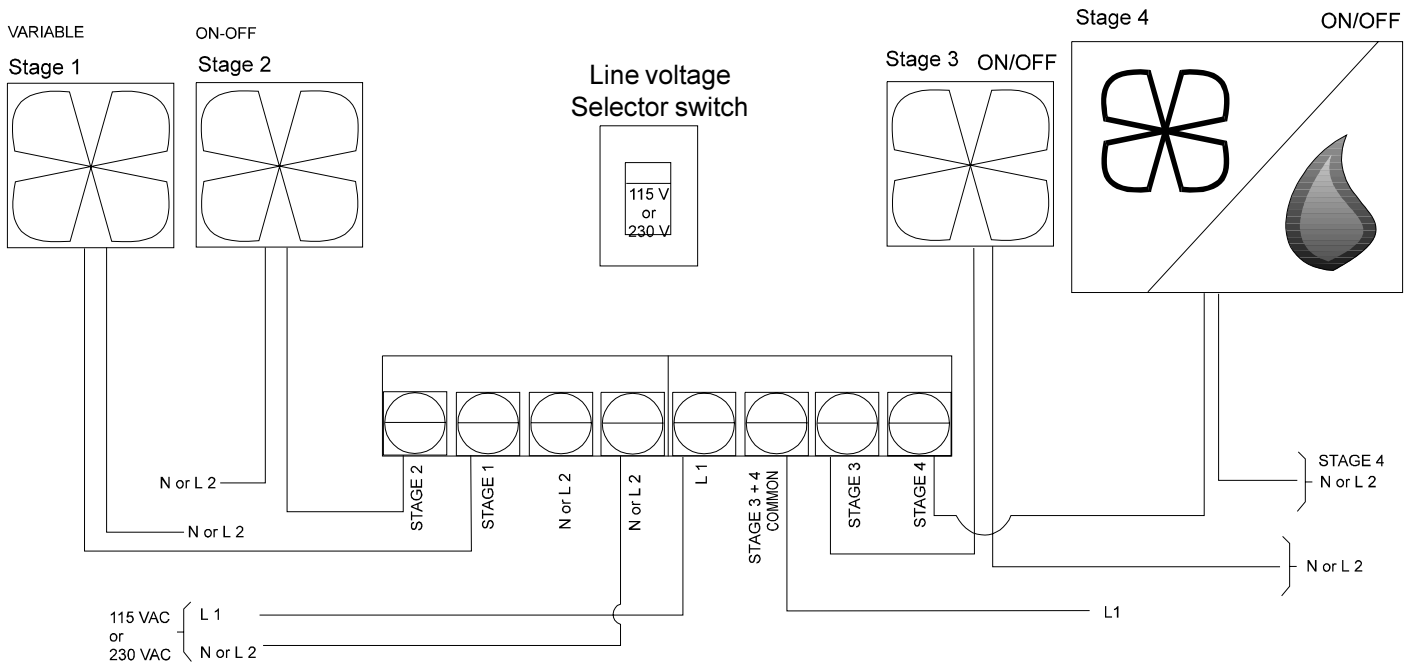
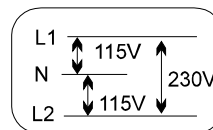

Figure 4 : Wiring of the ST-2112

WARNING

Each ON-OFF output has a 6 Amp. max. motor load capacity.



TEMPERATURE PROBE

The temperature probe operates at low voltage and is completely isolated from line voltage. It can be extended up to 500 feet.

To extend the probe :

- Use shielded cable with an outside diameter between .245 and .260 inch to ensure cable entry is dust tight.
- Isolate this cable from any other cable.

ELECTRICAL RATINGS

Power source : 115 VAC or 230 VAC, 60 Hz

Stage 1 output : 10 Amp. max., variable voltage from 0 Volt up to supply voltage, *Fuses :* 15 Amp., slow blow

Stages 2,3 and 4 outputs : 250 VAC, 10 Amp. resistive max. or 6 Amp. inductive max., *Fuses :* 15 Amp., slow blow

Probe : Low voltage (< 5V), isolated from line voltage, can be extended up to 500 feet. Accuracy : 1°C (1.8°F) between 5° and 35°C (41° and 95°F)

Operating temperature range : 0° to 40°C (32° to 104°F)

Casing : ABS, moisture and dust tight

WARNING

DO NOT SPLASH WATER ON CONTROLLER