

# Technical Information

## Wall Openings Fans and Cooling

## Wall Openings

Evaporative Cooling CT & CN, VX Fans, WM Fans, WS Fans,  
Classic Fans, Grower Fans, AT Fans, WF Fans



## CT & CN Evaporative Cooling System

'CT' System

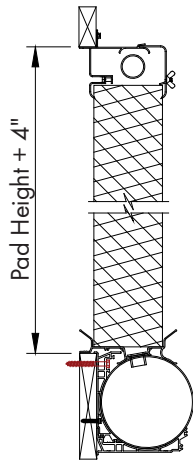

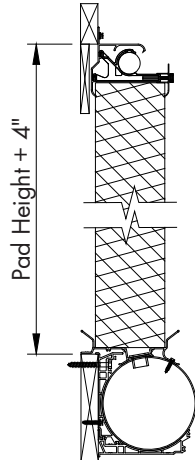

'CN' System

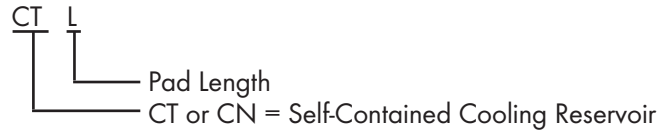

### Catalog Number Definition



System Length	Framed Wall Openings	
 all Lengths	Pad Length + 1/2"	Pad Height + 4"
 all Lengths	Pad Length + 1/2"	Pad Height + 4"

Example of (6) CT 10 with 5' Pad (CEL1545061260M1):  
60' Length and 60" Height = 60'-1/2"L. x 64"H.

## VX and Classic Fans 14" thru 26"

VX

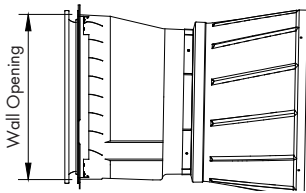

Prop. Dia.	Wall Opening
14"	17 1/2" Sq.
16"	22 1/2" Sq.
18"	22 1/2" Sq.
24"	28 1/2" Sq.
26"	30 1/4" Sq.

Classic F and G-Series - No Wall Housings (Wood Framing)

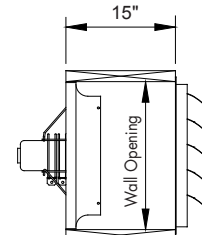
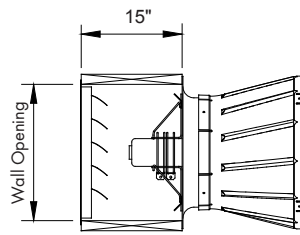

Prop. Dia.	Wall Opening
14"	17 1/4" Sq.
16"	20 1/4" Sq.
18"	22 1/4" Sq.
24"	28 1/4" Sq.

## Grower Fans 24" thru 36"

Grower M and Q-Series

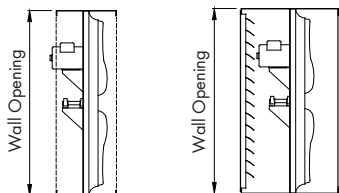

Prop. Dia.	Wall Opening
24"	28 1/2" Sq.
36"	43" Sq.

Grower H-Series

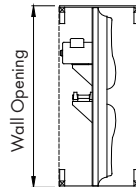

Prop. Dia.	Wall Opening
24"	29 1/2" Sq.
36"	43 1/2" Sq.

### Recommended Clearance\*

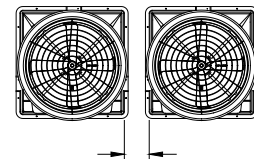

- Fan with outlet guard: maintain 8" minimum clearance on all sides
  - Fan with discharge cone: maintain 12" minimum clearance on all sides
- \*contact office for fan specific minimums

Note: All Dimensions shown are for I.D. of finished framed openings.

# VX, WM, WS, AX, Grower & WF Fans 36" thru 55"

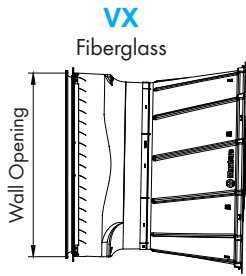

Prop. Dia.	Wall Opening
36"	43" Sq.
48"	55" Sq.
51"	56¼"W. x 57¾"H.
55"	60"W. x 61¼"H.

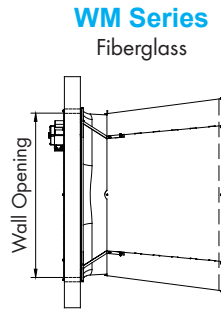

Prop. Dia.	Wall Opening
36"	44½" x 44½"
54"	56½" x 56½"

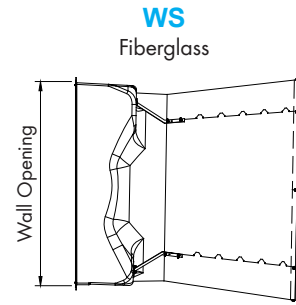

Prop. Dia.	Wall Opening
55"	60"W. x 61¼"H.

**CAUTION** All T-Series wall openings are for 2x4 framed walls, for other wall thicknesses contact Munters or refer to product installation instructions.

## WF T-Series with cone Tilt Wall Housings

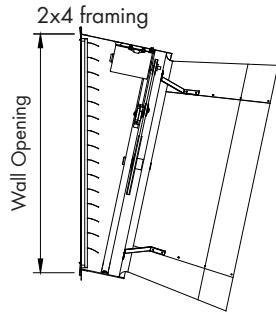

Prop. Dia.	Wall Opening
50"	55" W. x 56¼" H.
54"	56½" W. x 62½" H.

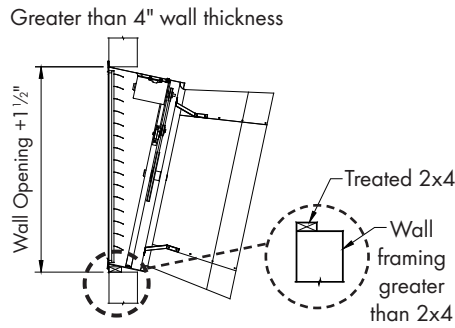

Wall Opening	Wall Opening
55" W. x 57¾" H.	56½" W. x 64" H.

## WF Damper Series Straight Wall Housings

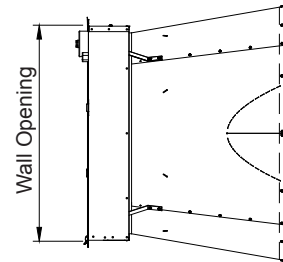

Prop. Dia.	Wall Opening
50"	54½" W. x 54½" H.
54"	58½" W. x 60½" H.

## AX and Grower T-Series with cone Tilt Wall Housings

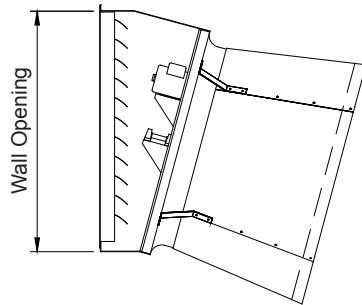

Prop. Dia.	Wall Opening
36"	43" W. x 45" H.

## AX and Grower G-Series Fan Only Wood Framing

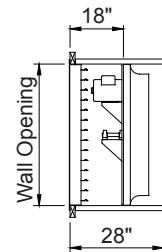

Prop. Dia.	Wall Opening
36"	42¼" Sq.
48"	54¼" Sq.
51"	56¼" Sq.

### Notes:

- Contact Munters for 5'O.C. post building construction
- All Dimensions shown are for I.D. of finished framed openings.

### Recommended Clearance\*

- Fan with outlet guard: maintain 8" minimum clearance on all sides
- Fan with discharge cone: maintain 12" minimum clearance on all sides

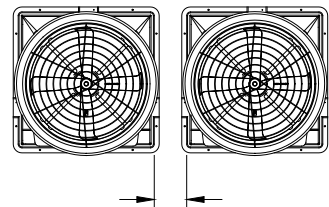

Munters Corporation, Lansing, Michigan U.S.A. 1-800-227-2376



Munters Europe AB, Isafjordsgatan 1, P.O. Box 1150, SE-164 26 Kista, Sweden. Phone +46 08 626 63 00, Fax +46 8 754 56 66.

Munters Corporation 2691 Ena Drive Lansing, MI 48917 U.S.A. Phone +1 800-227-2376, Fax +1 517-676-7078

[www.munters.us](http://www.munters.us)

**Australia** Munters Pty Limited, Phone +61 2 6025 6422, **Brazil** Munters Brasil Industria e Comercio Ltda, Phone +55 41 3317 5050, **Canada/US** Munters Corporation Lansing, MI Phone +1 517 676 7070, **China** Munters Air Treatment Equipment (Beijing) Co. Ltd, Phone +86 10 80 481 121, **Denmark** Munters A/S, Phone +45 9862 3311, **India** Munters India, Phone +91 20 3052 2520, **Indonesia** Munters, Phone +62 818 739 235, **Italy** Munters Italy S.p.A., Chiusavecchia, Phone +39 0183 52 11, **Japan** Munters K.K., Phone +81 3 5970 0021, **Korea** Munters Korea Co. Ltd., Phone +82 2 761 8701, **Mexico** Munters Mexico, Phone +52 818 262 54 00, **Russia** Munters AB, Phone +7 812 448 5740, **Singapore** Munters Pte Ltd., Phone +65 744 6828, **South Africa and Sub-Sahara Countries** Munters (Pty) Ltd., Phone +27 11 997 2000, **Spain** Munters Spain S.A., Phone +34 91 640 09 02, **Sweden** Munters AB, Phone +46 8 626 63 00, **Thailand** Munters Co. Ltd., Phone +66 2 642 2670, **Turkey** Munters Form Endüstri Sistemleri A.Ş, Phone +90 322 231 1338, **USA** Munters Corporation, Lansing MI Phone +1 517 676 7070, **Vietnam** Munters Vietnam, Phone +84 8 3825 6838, **Export & Other countries** Munters Italy S.p.A., Chiusavecchia Phone +39 0183 52 11

Munters reserves the right to make alterations to specifications, quantities, etc., for production or other reasons, subsequent to publication.

© Munters AB, 2018