

Temperature Controller

ST 50210

USER'S MANUAL

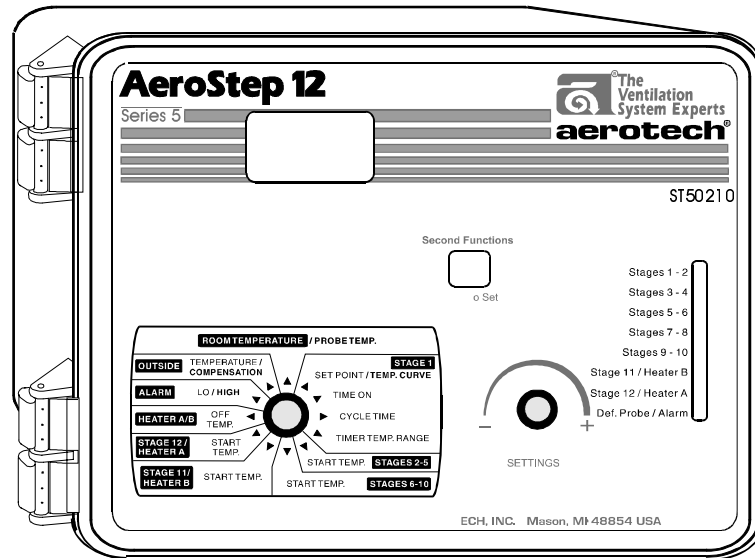

TABLE OF CONTENTS

	Page
PRECAUTIONS	3
FEATURES	4
LOCATION OF THE CONTROLS	6
Controller Status Leds	7
Internal Switches	7
INSTALLATION	8
Mounting Instructions	8
Connections	8
Heating / Cooling Option	9
Temperature Probes	9
CHANGING THE PARAMETER SETTINGS	12
The Meaning of a Flashing Display	12
Locking the Parameters Settings	13
TEMPERATURE SETTINGS	13
Temperature Units	13
Viewing Temperatures	13
Temperature Set Point	16
Temperature Curve	17
VENTILATION SETTINGS	21
Cooling Operation	21
Minimum Ventilation Cycle	23
Minimum Ventilation Compensation	27
Ventilation Settings	29
Mist Cooling	30
HEATER SETTINGS	33
ALARM SETTINGS	39
TROUBLESHOOTING GUIDE	40
TECHNICAL SPECIFICATIONS	44
FACTORY SETTINGS	46

PRECAUTIONS

We strongly recommend installing supplementary natural ventilation, a failure alarm system as well as a back-up thermostat on at least one cooling stage (refer to the wiring diagram enclosed with this user's manual to connect the thermostat).

Although fuses at the input and outputs of the controller protect its circuits in case of an overload or overvoltage, we recommend installing an additional protection device on the supply circuit as well as an external relay on all ON-OFF stages to prolong the life of the controller.

The room temperature where the controller is located **MUST ALWAYS REMAIN BETWEEN 32°F AND 104°F (0°C TO 40°C)**.

To avoid exposing the controller to harmful gases or excessive humidity, it is preferable to install it in a corridor.

DO NOT SPRAY WATER ON THE CONTROLLER

FOR CUSTOMER USE
 Enter below the serial number located on the side of the controller and retain this information for future reference.

Model number: ST 50210
 Serial number: _____
 Date installed: _____

The ST 50210 is an electronic device used for environmental control in livestock buildings. It allows the user to maintain a specified target temperature by controlling the operation of ventilation and heating equipment. Ten stages of constant-speed cooling fans can be connected to the controller, as well as two stages of either constant-speed fans or heating units. In addition, the last cooling stage can be configured as a mist cooling stage.

The main features of the ST 50210 are as follows:

THREE-DIGIT DISPLAY

A three-digit display provides a high level of accuracy, allowing the user to specify a temperature to within one tenth of a degree (in Fahrenheit or Celsius units).

PILOT LIGHTS

Pilot lights indicating the state of outputs allow the user to monitor the operation of the system without having to enter the building.

MINIMUM VENTILATION CYCLE

When ventilation is not required for cooling, the first stage fans can be operated either continuously or intermittently to reduce the level of humidity and supply oxygen to the room.

MINIMUM VENTILATION COMPENSATION CURVE

An outside probe can be connected to the controller to adjust the minimum ventilation cycle as a function of outside temperature.

TEMPERATURE CURVE

The controller can be set to automatically change the temperature set point over a given period of time in accordance with the user's requirements by specifying a temperature curve with up to six different points.

FOUR INDEPENDENT TEMPERATURE PROBE INPUTS

Up to four temperature probes can be connected to the controller in order to obtain a more accurate reading of the average room temperature and a faster

reaction time.

ZONED OR STAGED HEATERS

OVERLOAD AND OVERVOLTAGE PROTECTION

Fuses are installed at the input and outputs of the controller to protect its circuitry in the case of an overload or overvoltage.

COMPUTER CONTROL

The controller can be connected to a computer, thus making it possible to centralize the management of information and diversify control strategies.

CONTROL OF AIR INLET MOVEMENT

If the ST 50210 is used in combination with a SB 2000 controller, the movement of the air inlets can be coordinated with the operation of the fans using a potentiometer located on the curtain machine or baffle actuator. This allows the air inlets to be adjusted correctly, without the influence of uncontrollable factors such as wind or air from adjoining rooms. When tunnel ventilation is being used, the SB 2000 closes the air inlets.

HIGH/LOW TEMPERATURE ALARM OUTPUT

LOCATION OF THE CONTROLS

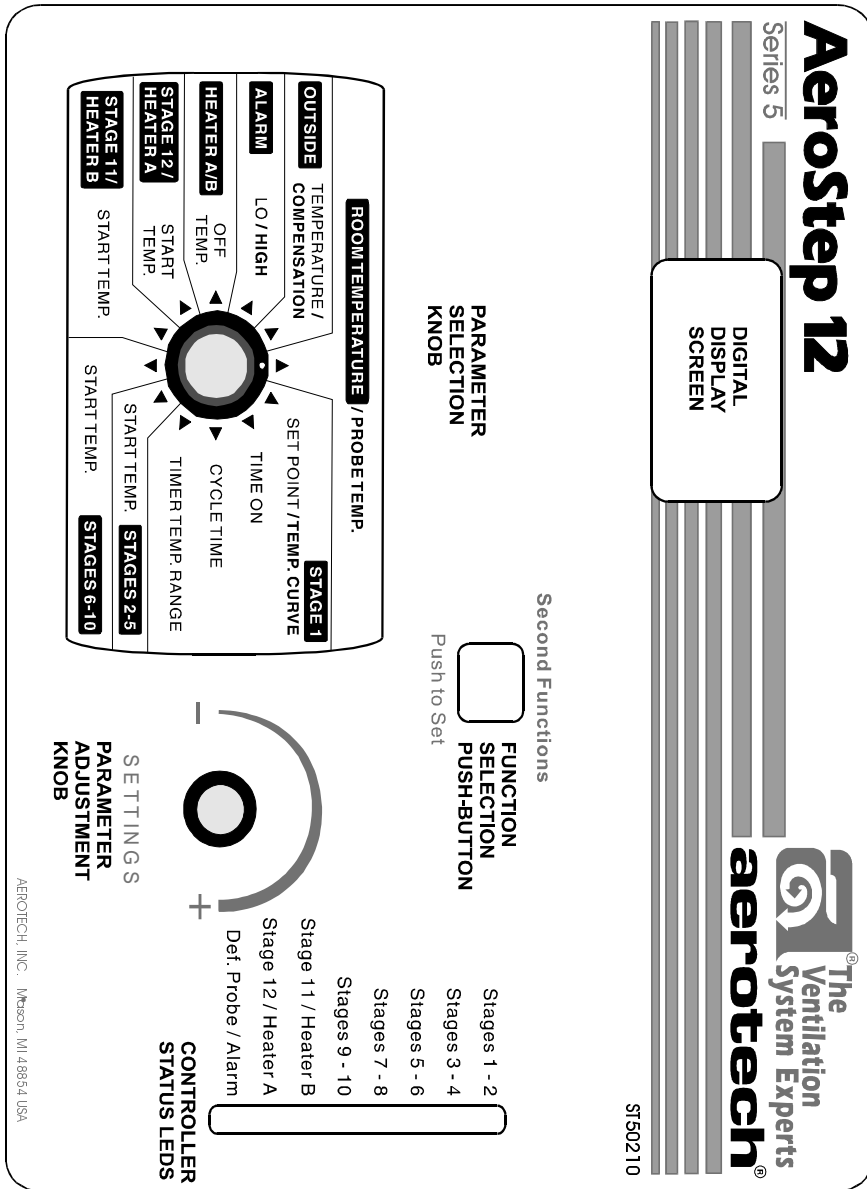

ST 50210

CONTROLLER STATUS LEDES

LED	MEANING
STAGES 1-2	FLASHES WHEN STAGE 1 FANS ARE ON. TURNS ON WHEN STAGE 2 FANS ARE ON.
STAGES 3-4	FLASHES WHEN STAGE 3 FANS ARE ON. TURNS ON WHEN STAGE 4 FANS ARE ON.
STAGES 5-6	FLASHES WHEN STAGE 5 FANS ARE ON. TURNS ON WHEN STAGE 6 FANS ARE ON.
STAGES 7-8	FLASHES WHEN STAGE 7 FANS ARE ON. TURNS ON WHEN STAGE 8 FANS ARE ON.
STAGES 9-10	FLASHES WHEN STAGE 9 FANS ARE ON. TURNS ON WHEN STAGE 10 FANS ARE ON.
STAGE 11 / HEATER B	TURNS ON WHEN STAGE 11 FANS OR HEATING UNITS ARE ON.
STAGE 12 / HEATER A	TURNS ON WHEN STAGE 12 FANS OR HEATING UNITS ARE ON.
DEF. PROBE / ALARM	TURNS ON WHEN AN ALARM IS DETECTED. FLASHES WHEN A DEFECTIVE PROBE IS DETECTED.

INTERNAL SWITCHES

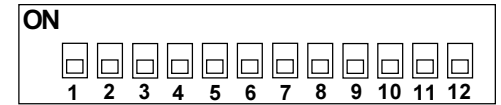

The internal switches are located on the inside of the front cover. When the controller is shipped from the factory, all the switches are set to OFF.

#	OFF	ON
1	UNLOCKED PARAMETERS	LOCKED PARAMETERS
2	FAHRENHEIT DEGREES	CELSIUS DEGREES
3	NO HEATING STAGES	HEATING
4	1 HEATER	2 HEATERS
5	STAGED HEATERS	ZONED HEATERS
6	STAGE 1 WITHOUT RAMPING	STAGE 1 WITH RAMPING
7	OUTSIDE PROBE DISABLED	OUTSIDE PROBE ENABLED

MOUNTING INSTRUCTIONS

Open the latch and lift the cover. Remove the black caps located on each of the four mounting holes. Mount the enclosure on the wall using four screws. Be sure the electrical knockouts are at the bottom of the enclosure in order to prevent water from entering the controller. Insert the screws in the mounting holes and tighten. Fasten the four black caps provided with the controller onto the four mounting holes. The enclosure must be mounted in a location that will allow the cover to be completely opened right up against the wall.

CONNECTIONS

To connect the controller, refer to the wiring diagram enclosed with this user's manual.

- Set the voltage switch to the appropriate voltage.
- Use the electrical knockouts provided at the bottom of the enclosure. Do not make additional holes in the enclosure, particularly on the top of the enclosure when using a SL 1400 communication board.
- If metallic cable holders are used to secure cables entering the enclosure, use the ground plate provided with the controller. Connect the ground wire to the ground stud on the plate.
- For the heating stages, it may be necessary to install a transformer in order to supply the appropriate voltage to the heating unit.

ALARM CONNECTION: There are two types of alarms on the market. One type activates when current is cut off at its input, whereas the other activates when current is supplied at its input. For an alarm of the first type, use the NO terminal as shown on the wiring diagram. For an alarm of the second type, use the NC terminal.



ALL WIRING MUST BE DONE BY AN AUTHORIZED ELECTRICIAN AND MUST COMPLY WITH APPLICABLE CODES, LAWS AND REGULATIONS. BE SURE POWER IS OFF BEFORE DOING ANY WIRING TO AVOID ELECTRICAL SHOCKS AND EQUIPMENT DAMAGE.

HEATING / COOLING OPTION

Stages 11 and 12 can operate as heating or cooling stages.

⇒ Set switches # 3 and # 4 to **OFF** to use both stages for cooling.

⇒ Set switch # 3 to **ON** and switch # 4 to **OFF** to use Stage 12 for heating and Stage 11 for cooling.

⇒ Set switches # 3 and # 4 to **ON** to use both stages for heating.

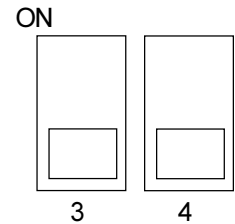

Note that if only one stage is used for heating, it must be Stage 12.

TEMPERATURE PROBES

1 Connecting the Probes

The controller is supplied with one indoor temperature probe. Three additional indoor probes can be connected to obtain more accurate readings or to control different parts of the building. In addition, an outdoor probe can be connected if the compensation function on the minimum ventilation cycle is needed (see the chapter on ventilation).

⇒ Use terminals # 2, 3 and 4 to connect additional indoor probes and terminal # 5 to connect the outdoor probe, as shown on the wiring diagram enclosed.

CAUTION: Probes operate at low voltage and are isolated from the supply. Be sure that probe cables remain isolated from all high voltage sources. In particular, do not route the probe cables through the same electrical knockout as other cables. Do not connect the shield from the probe cable to an input or a ground.

2 Extending the Probes

Each probe can be extended up to 500 feet (150 meters). To extend a probe:

- Use a shielded cable of outside diameter between 0.245 and 0.260 in (6.22 and 6.60 mm) (the cable dimensions should not be under 18 AWG) to ensure the cable entry is liquid tight. Do not ground the shielding.
- It is preferable to solder the cable joint to ensure a proper contact between the two cables.

CAUTION: Do not run probe cables next to other power cables. When crossing over other cables, cross at 90°.

3 Installing the Outside Probe

- Run the outside probe cable on the north side of the building, 6 ft (2 m) below the eave, inside a pale colored conduit. Avoid installing the probe in direct sunlight or exposed to the rain.
- Be sure the probe cable is isolated from sheet metal or any other conductive material.
- Be sure no cable joint is exposed to air or water.

4 Defective Probes

If a defective probe is detected, the Defective Probe Pilot Light turns on. The room temperature shown on the display is then the average temperature measured by the probes in working condition. The controller will operate according to this temperature.

To identify the defective probe:

- Set the selection knob to **ROOM TEMPERATURE**. The room temperature is displayed.
- Press the push-button. If the probe connected to input # 1 and supplied with the controller is not defective, the letters "PR1" are displayed, alternating with the on/off state of the probe and the temperature measured by the probe.

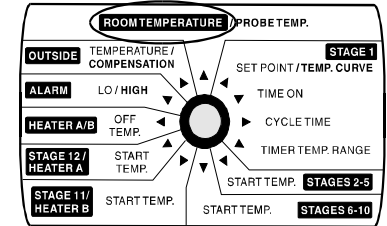

If the probe is defective, the letters "PR1" are displayed, alternating with the state of the probe and the letter "P".

For each additional probe connected to the controller:

- Press the push-button once again. If the probe is not defective, the letters "PR#" (where # is the number of the input to which the probe is connected) are displayed, alternating with the on/off state of the probe and the temperature measured by the probe. If the probe is defective, the letters "PR#" are displayed, alternating with the on/off state of the probe and the letter "P".

Outside Probe: If the outside probe is defective, the display shows the letter "P" when the parameter selection knob is set to **OUTSIDE TEMP**.

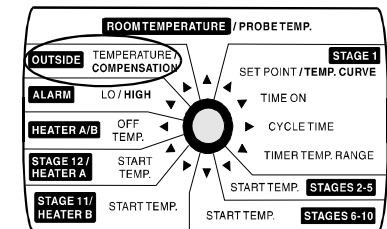

CHANGING THE PARAMETER SETTINGS

THE MEANING OF A FLASHING DISPLAY

The display will flash in certain cases and not in others. The flashing indicates that the value shown can be adjusted. A value that is not flashing cannot be adjusted.

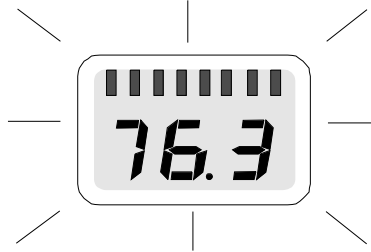

LOCKING THE PARAMETER SETTINGS

The parameter settings can be locked to prevent accidentally modifying them. When the settings are locked, only the temperature set point can be modified (as long as the temperature curve is deactivated).

To lock the parameter settings:

- Set internal switch # 1 to **ON**. The Locked Parameter Pilot Light turns on.

To unlock the parameter settings:

- Set internal switch # 1 to **OFF**. The Locked Parameter Pilot Light turns off.

TEMPERATURE SETTINGS

TEMPERATURE UNITS

Temperatures can be displayed in either Celsius or Fahrenheit units

- Set internal switch # 2 to the desired position:

- **ON** to display temperatures in Celsius units.
- **OFF** to display temperatures in Fahrenheit units.

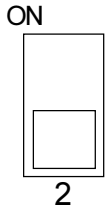

VIEWING TEMPERATURES

The readout can display values from -40.0°F to 120°F (-40.0°C to 48.9°C). When the temperature drops below -9.9 degrees, the negative sign is displayed separately, alternating with the numerical value.

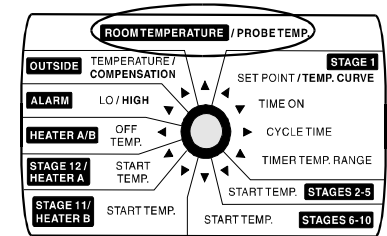

1 Viewing Room Temperature

The room temperature is the average value of all temperatures measured by activated probes in proper operating condition.

- Set the selection knob to **ROOM TEMPERATURE / PROBE TEMP**. The room temperature is displayed.

2 Viewing Outside Temperature

The outside temperature can be displayed only if an outside probe has been connected to terminal # 5 and internal switch # 7 is set to ON.

- Set the selection knob to **OUTSIDE — TEMP. / COMPENSATION**. The outside temperature is displayed.

3 Viewing Probe Temperatures

The controller can display probe temperatures individually. Probes can also be turned on or off to control the temperature in different parts of the building.

- Set selection knob to **ROOM TEMPERATURE / PROBE TEMP.** The average room temperature is displayed.
- Press the push-button. The temperature reading from probe 1 is displayed, alternating with the letters "**Pr 1**" and the on/off state of probe 1.
- For each additional probe, press the push-button. The temperature reading from probe x is displayed, alternating with the letters "**Pr x**" and the on/off state of the probe, etc.
- Press the push-button once again to display the letters "**Pr 1**" alternating with the state of probe 1, i.e. ON / OFF (flashing). When a probe is activated, it is used in the calculation of the average room temperature.
- Use the adjustment knob to change the state of the probe.
- For each additional probe, press the push-button. The state of probe is displayed, alternating with the letters "**Pr x**", etc.

NOTES:

- i) At least one probe must be activated at all times. If only one probe remains active, the controller will lock the on/off switch for that probe.
- ii) The display returns to the average room temperature after one minute.
- iii) Initially, only probe one is activated.

4 Viewing Minimum / Maximum Temperatures

The minimum and maximum temperatures are the lowest and highest temperature values recorded since the last reset. Maximum and minimum temperatures values are recorded for the average room temperature as well as for individual probe temperatures.

- Set the selection knob to **ROOM TEMPERATURE / PROBE TEMP.** The room temperature is displayed.
- Turn the adjustment knob clockwise by one notch. The minimum temperature is displayed, alternating with the letters "**Lo**".
- Turn the adjustment knob clockwise one notch further. The maximum temperature is displayed, alternating with the letters "**Hi**".
- Turn the adjustment knob clockwise a third notch. The room temperature is displayed again.
- For each individual probe, press the push-button. The temperature reading from probe x is displayed, alternating with the letters "**Pr x**" and the on/off state of the probe.
- Turn the adjustment knob clockwise by one notch. The minimum temperature is displayed, alternating with the letters "**Lo**".
- Turn the adjustment knob clockwise one notch further. The maximum temperature is displayed, alternating with the letters "**Hi**".
- Turn the adjustment knob clockwise a third notch. The probe temperature is displayed again.
- For each additional probe, press the push-button. The temperature reading from probe x is displayed, alternating with the letters "**Pr x**" and the on/off state of the probe, etc.

NOTE: If you let the display flash for more than 10 seconds, the controller resets the minimum and maximum temperatures currently in memory (the display stops flashing to indicate that the reset has been done).

TEMPERATURE SET POINT

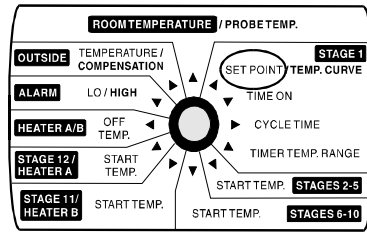

The temperature set point is the target room temperature. It can be adjusted between -40.0°F and 99.9°F (-40.0°C and 37.7°C).

Adjusting the Temperature Set Point

- Set the selection knob to **SET POINT / TEMP. CURVE**. The current set point flashes on the display.
- Use the adjustment knob to adjust the set point to the desired value.

NOTE: The temperature set point can be adjusted only if the temperature curve is deactivated (see following section).

TEMPERATURE CURVE

The user can define a temperature curve to adjust the set point automatically over a given time period.

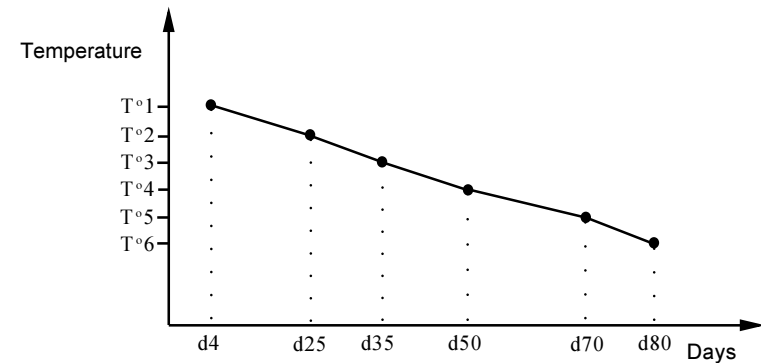

A curve is defined using six points. Each point specifies a day number and a set point for that day. Once the points of the curve are defined, the curve must be activated. The controller will change the temperature set point every hour in a linear fashion between consecutive points of the curve. When the last point of the curve is reached, the temperature set point for that day is maintained until the curve is reactivated.

NOTES :

- i) All six points of the curve must be specified. If six points are not needed, repeat the last temperature value for each unnecessary point.
- ii) Certain restrictions apply to reduce the risk of errors:
 - The highest possible day number is 99.
 - Decreasing day numbers are not allowed.
 - Increasing temperatures are not allowed.
 - The temperature variation cannot exceed 3°F (1.6°C) per day.

1 Specifying the Curve

- Set the selection knob to **SET POINT / TEMP. CURVE**. The current temperature set point flashes on the display.

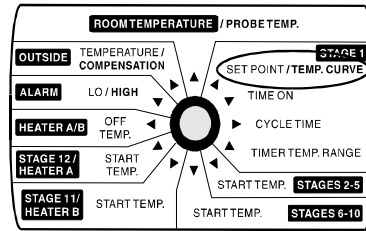

- Press the push-button. The word **OFF** is displayed indicating that the temperature curve is deactivated. If this is not the case, see below to deactivate the curve.

Repeat the following steps for each of the six points:

- Press the push-button once again. The day number is displayed, alternating with the word "**day**".
- Using the adjustment knob, set the day number to the desired value.
- Press the push-button once again. The current temperature set point is displayed, alternating with the word "**set**".
- Using the adjustment knob, adjust the set point to the desired value.

Once the six points of the curve have been specified, activate the curve as explained below.

NOTE: Make sure the temperature curve is deactivated before specifying new points (see below).

2 Activating the Temperature Curve

If you have just finished specifying the points on the curve:

- Press the push-button once again. The word **OFF** flashes on the display.
- Turn the adjustment knob clockwise one notch. The word **ON** flashes on the display and the Temperature Curve Pilot Light flashes, indicating that the temperature curve is now activated.
- Set the selection knob to **ROOM TEMPERATURE**.

If you have previously defined the points on the curve:

- Set the selection knob to **SET POINT / TEMP. CURVE**. The current value of the temperature set point flashes on the display.
- Press the push-button. The word **OFF** is displayed.
- Press the push-button to display the points of the curve currently defined until the word **OFF** appears (thirteen clicks).
- Turn the adjustment knob clockwise one notch. The word **ON** flashes on the display and the Temperature Curve Pilot Light flashes, indicating that the temperature curve is now activated.
- Set the selection knob to **ROOM TEMPERATURE**.

3 Viewing Current Set Point and Day Number

When the temperature curve is activated, the current temperature set point and day number can be viewed at any time. The current day number can also be adjusted in order to move forward or backward on the temperature curve.

- Set the selection knob to **SET POINT / TEMP. CURVE**. The current temperature set point is displayed.
- Press the push-button. The current day number is displayed, alternating with the letters "**cur.day**".
- Use the adjustment knob to set the day number to the desired value.

4 Deactivating the Temperature Curve

- Set the selection knob to **SET POINT / TEMP. CURVE**. The current temperature set point is displayed.
- Press the push-button to display the points of the curve actually defined until the word **ON** appears (fourteen clicks).
- Turn the adjustment knob counterclockwise one notch. The word **OFF** flashes on the display and the Temperature Curve Pilot Light turns off, indicating that the temperature curve is now deactivated.
- Set the selection knob to **ROOM TEMPERATURE**.

COOLING OPERATION

The ST 50210 controls ten stages of constant-speed fans (Stages 1 - 10) and two optional stages of constant-speed fans (Stages 11 & 12). For the description that follows, refer to the diagram on the following page.

If room temperature rises:

- When **room temperature < Set Point + Timer Temp. Range**, stage 1 fans run according to the minimum ventilation cycle.
- **At Set Point + Timer Temp. Range**: stage 1 fans run continuously.
- **At Stage 2 Starting Temp**: stage 2 fans start running.
- **At Stage 3 Starting Temp**: stage 3 fans start running.
- **At Stage 12 Starting Temp**: stage 12 fans start running.

⋮

If the room temperature falls:

- **At Stage 12 Starting Temp - 1.5°F**: stage 12 fans return to a stop.
- **At Stage 11 Starting Temp - 1.5°F**: stage 11 fans return to a stop.
- **At Stage 2 Starting Temp - 1.5°F**: stage 2 fans return to a stop.
- **At Set Point + Timer Temp. Range - 1.5°F**: Stage 1 fans start to run according to the minimum ventilation cycle.

⋮

FIGURE 1: COOLING

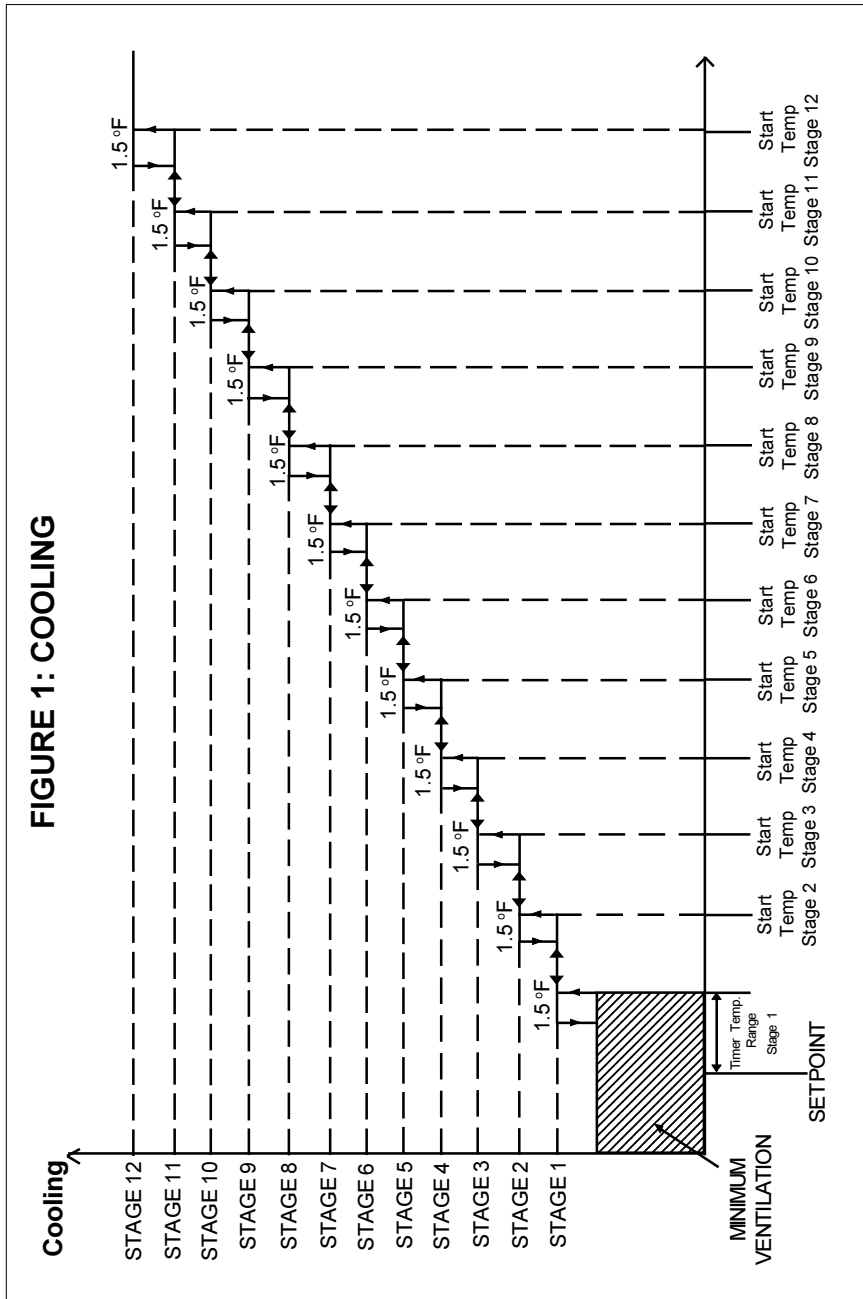

MINIMUM VENTILATION CYCLE

When the room temperature is below the set point, the Stage 1 fans operate according to the minimum ventilation cycle. Running the fans even though ventilation is not required for a cooling purpose is useful to reduce humidity levels and supply oxygen to the room. It also prevents the fans from freezing in winter.

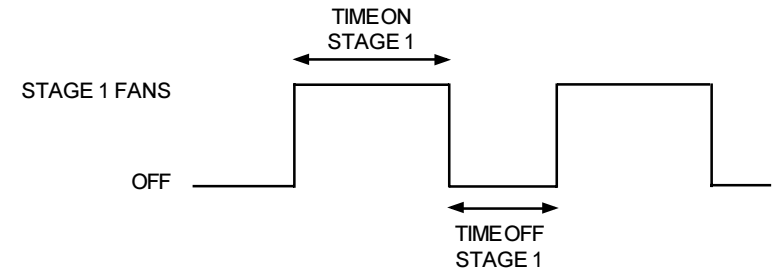

Stage 1 fans run during time on. The Stages 1-2 Pilot Light flashes. During time off, the Stage 1 fans do not run. The Stages 1-2 Pilot Light turns off.

Minimum Ventilation Cycle Settings

1. To run the fans continuously at minimum speed, set time off to zero and time on to any value other than zero.
2. To stop the fans, set time on to zero and time off to any value.
3. To run the fans intermittently, set time on to the desired running time and time off to the desired off time.

RAMPING OPTION

The user has two options for controlling the transition from the minimum ventilation cycle to full operation of the Stage 1 fans, i.e. in the temperature interval between the set point and the set point + timer temp. range. In the first option (ramping), the running time of the fans is increased (or decreased) gradually to smooth out the transition between full operation of Stage 1 fans and the minimum cycle. In the second option, no transition is made from the minimum cycle to full operation of the Stage 1 fans. The running time of the fans is simply defined according to the minimum ventilation cycle.

Option 1: With Ramping

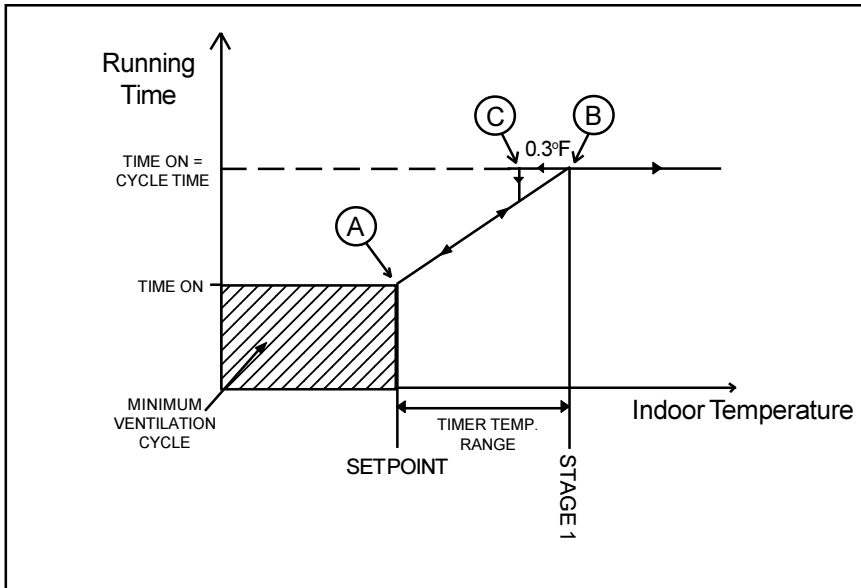

This option is activated by setting internal switch # 6 to ON. At room temperatures at or below the set point, the controller operates the Stage 1 fans according to the minimum ventilation cycle.

If the room temperature rises above the set point, a new TIME ON is calculated periodically as the temperature increases to allow a smooth progression (from point A to point B) up to full operation of the fans when the timer

temp. range is reached*.

If the room temperature decreases 0.3°F below the set point + timer temp. range, the TIME ON value of the minimum ventilation cycle decreases gradually from a value equal to the total cycle time (point C) to the value defined by the parameter settings (TIMER STAGE 1 - TIME ON).

Option 2: Without Ramping

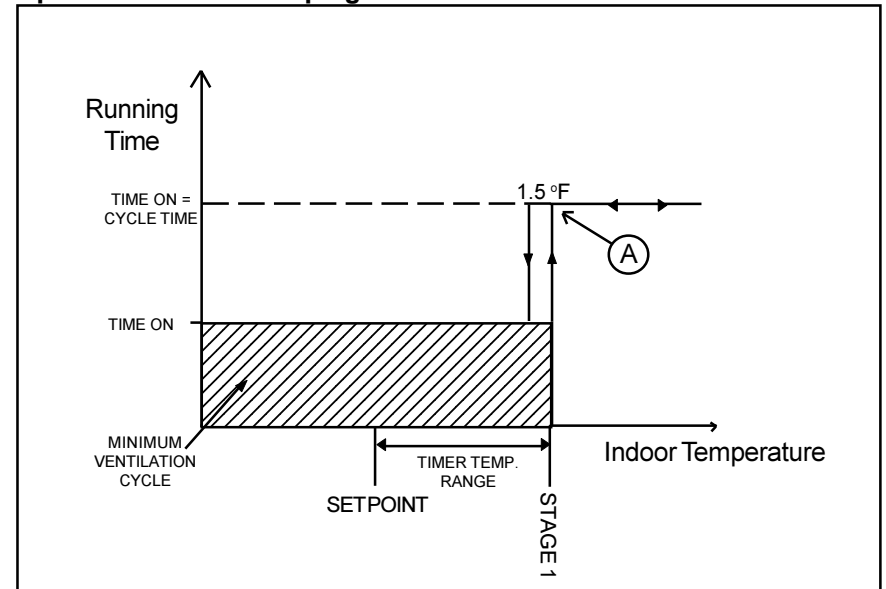

This option is activated by setting internal switch # 6 to OFF. When the temperature is less than the set point + timer temp. range, Stage 1 fans run according to the minimum cycle (see above). When the room temperature reaches point A, stage 1 fans run continuously with no transition.

When the temperature decreases 1.5°F below point A, Stage 1 fans start operating according to the minimum ventilation cycle.

* When Time Off becomes less than 15 seconds, it is fixed at 15 seconds until the temperature has reached the set point + timer temp. range. At that point, the stage 1 fans operate continuously.

1 Viewing and Adjusting Stage 1 Time On

- Set the selection knob to **STAGE 1 — TIME ON**. The current time on for Stage 1 flashes on the display, alternating with the letters "On".
- Use the adjustment knob to adjust time on to the desired value.
- If the ramping option has been enabled, the actual time on value may differ from the user-defined time on. To view the time on value actually used by the controller, press the push-button. The actual time on value is displayed for 1 minute, alternating with the letters "CAL". The display then returns to the user-defined value.

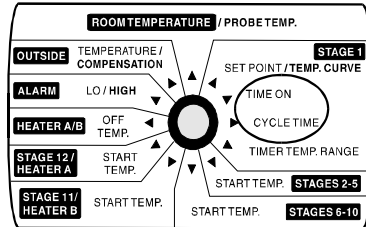

Time on can be adjusted between 0 and 900 seconds, in increments of 15 seconds.

2 Viewing and Adjusting Stage 1 Cycle Time / Time Off

- Set the selection knob to **STAGE 1 — CYCLE TIME**. The current cycle time for the Stage 1 timer flashes on the display, alternating with the letters "CyC".
- Use the adjustment knob to adjust cycle time on to the desired value.
- If you wish to view time off, press the push-button. This value may not simply be the difference between the cycle time and time on if the ramping option has been enabled. The time off value actually used by the controller is displayed for 1 minute. The display then returns to the cycle time.

The cycle time can be adjusted between 0 and 900 seconds, in increments of 15 seconds. The counter starts at the current time on value.

MINIMUM VENTILATION COMPENSATION

The ST 50210 has the capability of automatically adjusting the running time of the minimum ventilation fans as a function of outside temperature. As the weather gets colder, the on time is decreased gradually to compensate for the change. This can help reduce costs by reducing the ventilation when it is not required. A curve is used to calculate the required compensation as a percentage of current on time (see following page). Only the running time is adjusted; the total cycle time remains unchanged. Note that internal switch # 7 must be set to ON for this feature to work.

Examples of Ventilation Compensations

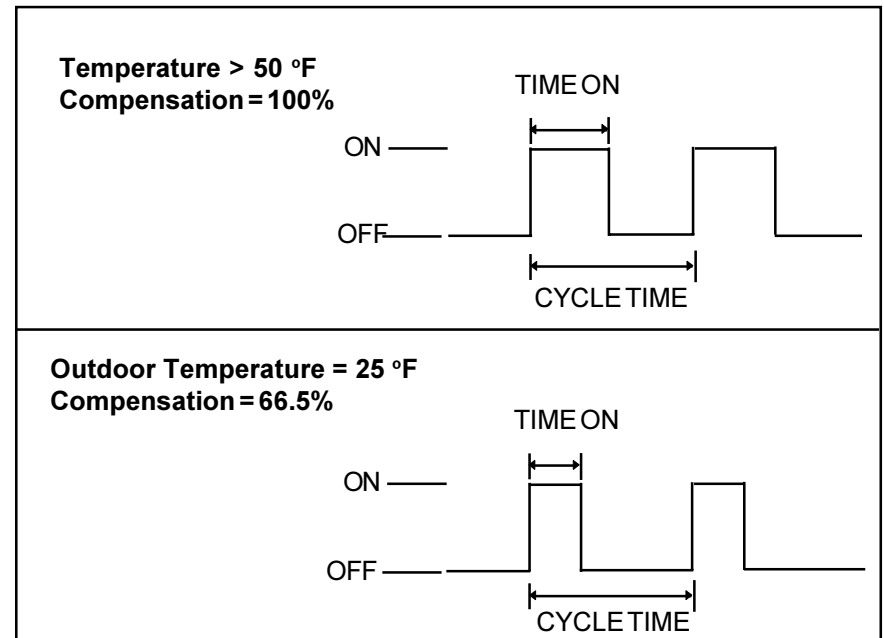

In the first example given on the following page, compensation is not needed when the outside temperature is greater than 50 °F. The fans operate according to the full running time defined by the parameter settings. In the second example, the running time is decreased to 66.5% of full running time to compensate for the colder outdoor temperature. Cycle time remains unchanged.

FIGURE 2: COMPENSATION CURVE

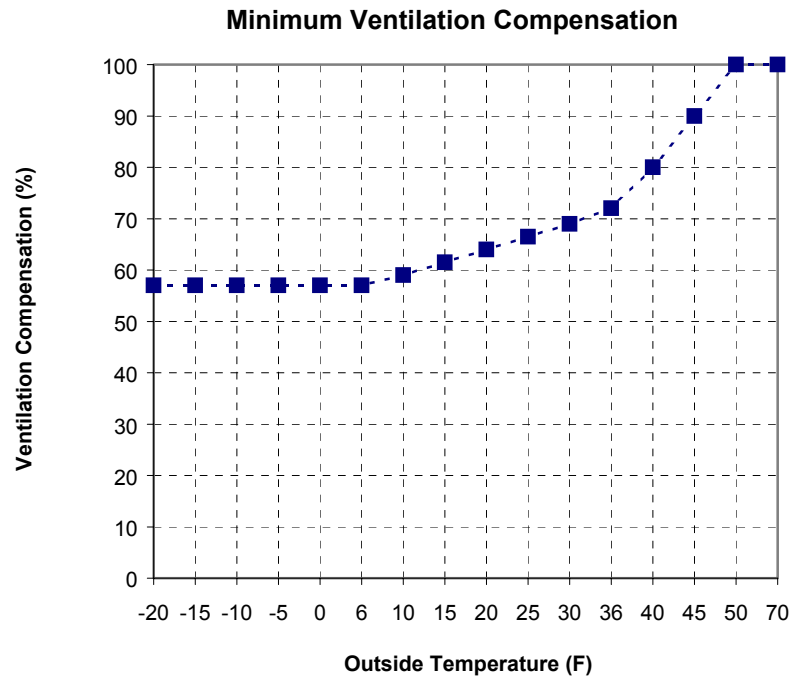

1 Activating / Deactivating Compensation Factor

- Set the selection knob to **OUTSIDE — TEMP./COMPENSATION**. The current outside temperature is displayed.
- Press the push-button. The status of the compensation factor is displayed, i.e. ON / OFF. Use the adjustment knob to set the status to the desired value. After ten seconds, the display returns to the outside temperature value.

NOTES:

- i) When the compensation factor is activated, the lowest time on value allowed after zero is 30 seconds.

- ii) The controller recalculates the compensation factor at the end of the time on portion of each timer cycle.

VENTILATION SETTINGS

1 Adjusting Stage 1 Timer Temperature Range

The stage 1 timer temperature range is the temperature difference between the set point and the temperature at which stage 1 fans run continuously. When this value is adjusted, all the starting values for consecutive stages are adjusted by the same amount. The timer temperature range can go from 0.5°F to 20.0°F (0.3°C and 11.1°C).

- Set the selection knob to **STAGE 1 — TIMER TEMP. RANGE**. The current timer temperature range flashes on the display.
- Use the adjustment knob to adjust the range to the desired value.

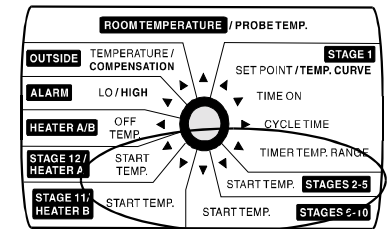

2 Adjusting Stages 2 - 12 Starting Temperatures

The starting temperature for a given stage is the temperature at which that stage starts. The hysteresis is fixed at 1.5°F and determines when the fans stop operating. When this value is adjusted, all the starting values for consecutive stages are adjusted by the same amount. The difference between between two consecutive starting temperatures can go from 0.5°F to 20.0°F (0.3°C and 11.1°C).

- Set the selection knob to the desired stage position. If the stage is combined with other stages, the starting temperature of the first stage is displayed, alternating with the letters "st.x" where x is the number of the stage. Otherwise, the starting temperature of the chosen stage flashes on the display.

- If the starting temperature displayed is the one to be adjusted, use the adjustment knob to set the temperature to the desired value. Otherwise, press the push-button until the starting temperature of the desired stage is displayed. Then, use the adjustment knob to set the temperature to the desired value.

MIST COOLING

The last cooling stage can be configured as a mist stage. The number of heating stages determines which stage this is.

NUMBER OF HEATING STAGES	MIST STAGE
0	12
1	11
2	10

To access the parameters, position the selector switch at the starting temperature of the mist stage. The parameter settings are as follows:

Starting Temperature (°F or °C) - The mist starting temperature is the temperature at which the mist units turn on (see the diagram below). The starting temperature minus 1 °F is the temperature at which the mist units turn off.

Time on (minutes) - The mist units operate according to a timer cycle. The time on is the running time of the mist units.

Time off (minutes) - The time off is the off time of the mist units. Note that time off must be non-zero in order for the controller to recognize the stage as a mist stage.

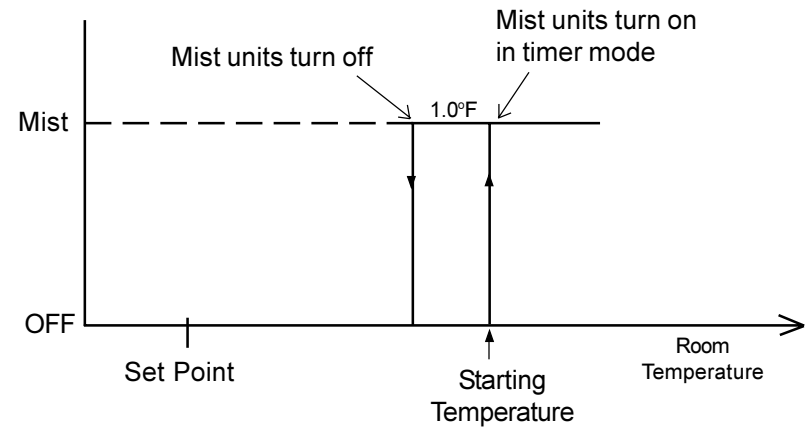
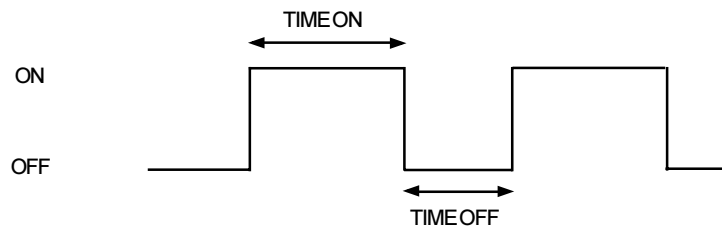

1 Adjusting the Mist Starting Temperature

The difference between the mist starting temperature and the starting temperature of the preceding stage can go from 0.5°F to 20.0°F (0.3°C and 11.1°C).

- Set the parameter selection knob to the starting temperature setting of the mist stage. The current starting temperature appears flashing on the display.
- Using the adjustment knob, set the starting temperature to the desired value.

2 Adjusting the Mist Timer Settings

Time on and Time off can be adjusted between 0 and 60 minutes, in increments of 1 minute.

- Set the parameter selection knob to the starting temperature setting of the mist stage. The current starting temperature appears flashing on the display.

ST 50210

- Push the push-button. The word "On" flashes on the display, alternating with the current time on value.
- Turn the adjustment knob to adjust the time on to the desired value (in minutes).
- Press the push-button once again. The word "Off" flashes on the display, alternating with the current time off value.
- Turn the adjustment knob to adjust the time off to the desired value (in minutes). Note that time off must be non-zero in order for the controller to operate the stage as a mist stage.

HEATER SETTINGS

STAGED HEATERS

To configure your system for staged heaters, set dipswitch # 5 to OFF. All heaters operate according to the average reading from all temperature probes and only one heater off temperature is needed.

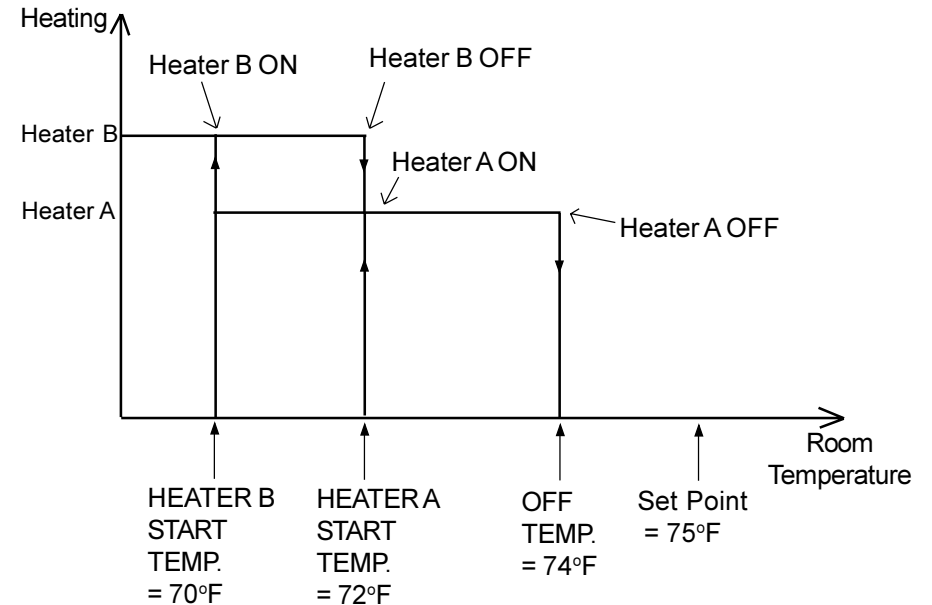

If the room temperature rises:

- at 72°F: Heater B turns off.
- at 74°F: Heater A turns off.

If the room temperature falls:

- at 72°F: Heater A turns on.
- at 70°F: Heater B turns on.

1 Adjusting Starting Temperatures for Staged Heaters

The heater starting temperature is the temperature at which the heating units turn on (see diagram above). The Heater A starting temperature is bounded above by the off temperature — 0.5°F and below by the off temperature — 20°F. The Heater B starting temperature is bounded above by the Heater A starting temperature — 0.5°F and below by the Heater A starting temperature — 20°F.

- Set selection knob to **HEATER A — START TEMP.** The current starting temperature for Heater A is displayed, alternating with the letters "Ht.A".

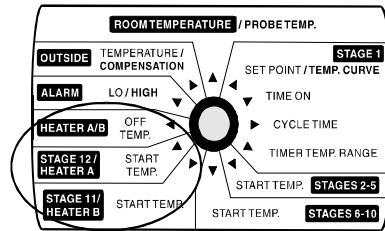

- Use the adjustment knob to adjust the starting temperature to the desired value.
- Set selection knob to **HEATER B — START TEMP.** The current starting temperature for Heater B is displayed, alternating with the letters "Ht.b".
- Use the adjustment knob to adjust the starting temperature to the desired value.

2 Adjusting Off Temperatures for Staged Heaters

The heater off temperature can provide substantial energy savings if correctly adjusted according to the outside temperature. It is the temperature below the set point at which the heating units turn off (see diagram above). The off temperature is bounded above by the set point + 10°F and below by the set point — 20°F.

- Set selection knob to **HEATER A/B — OFF TEMP.** The current off temperature is displayed, alternating with the letters "Ht.A".
- Use the adjustment knob to adjust the off temperature to the desired value.

ZONED HEATERS

To configure your system for zoned heaters, set dipswitch # 5 to ON. Since the two heater outputs function independently, different probes are assigned to each output: Probes 1 & 2 are assigned to Heater A and Probes 3 & 4 are assigned to Heater B. Individual probes can be turned on or off using the push-button functions contained in the ROOM TEMPERATURE function (see section on Temperature Settings).

Note that the heaters can become active only if the average temperature from all activated probes is below the set point. If this isn't the case, the heaters will not turn on even if individual probe temperatures are below the set point (this condition applies only if both off temperatures are below the set point).

Ventilation problems can result if heating levels in the two zones are very different. This is because the fans are operated according to the average temperature from all zones. Suppose the animals are young and confined

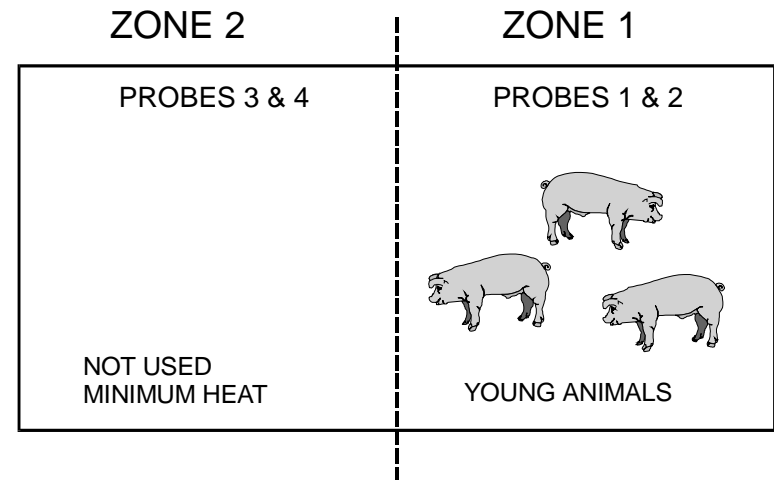

to one part of the building (zone 1) while the rest of the building is heated at a minimum level (zone 2). If the difference between the heating start temperatures is too great and zone 1 fans operate according to the average temperature for both zones, cooling in zone 1 may be insufficient. A built-in safeguard will operate the fans according to the probes of the zone with the highest heating start temperature whenever the difference between heating start temperatures is greater than 7.5°F.

The figure below explains the operation of zoned heaters.

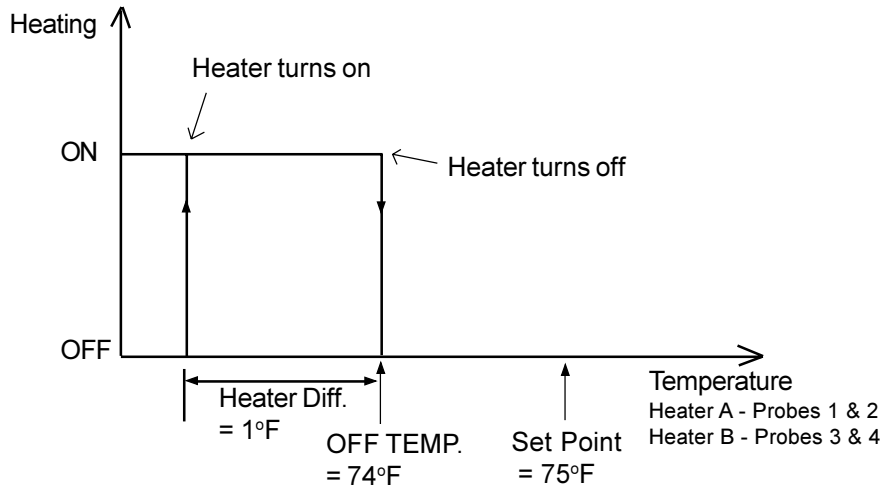

If the room temperature rises:

- at 74°F: Heater A (Probes 1 & 2) turns off. Heater B (Probes 3 & 4) turns off.

If the room temperature falls:

- at 73°F: Heater A (Probes 1 & 2) turns on. Heater B (Probes 3 & 4) turns on.

1 Adjusting Off Temperatures for Zoned Heaters

The heater off temperature can provide substantial energy savings if correctly adjusted according to the outside temperature. It is the temperature below the set point at which the heating units turn off (see diagram above). The off temperature is bounded above by the set point + 10°F (5.6°C) and below by the set point - 20°F (11.1°C).

- Set selection knob to **HEATER A/B — OFF TEMP.** The current off temperature for Heater A is displayed, alternating with the letters "Ht.A".

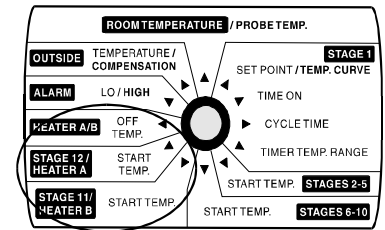

- Use the adjustment knob to adjust the off temperature to the desired value.
- Press the push-button. The current off temperature for Heater B is displayed, alternating with the letters "Ht.b".
- Use the adjustment knob to adjust the off temperature to the desired value.

2 Adjusting the Heater Starting Temperatures

The starting temperature is the temperature at which the heater turns on. The Heater A starting temperature is bounded above by the off temperature — 0.5°F and below by the off temperature — 20°F. The Heater B starting temperature is bounded above by the Heater A starting temperature — 0.5°F and below by the Heater A starting temperature — 20°F.

- Set the selection knob to **HEATER A — START TEMP**. The current starting temperature for Heater A is displayed, alternating with the letters "Ht.A".
- Use the adjustment knob to adjust the starting temperature to the desired value.
- Set the selection knob to **HEATER B — START TEMP**. The current starting temperature for Heater B is displayed, alternating with the letters "Ht.B".
- Use the adjustment knob to adjust the starting temperature to the desired value.

The controller sets off an alarm in the case of a power failure, a fault in the supply circuit or a high or low temperature. Temperature alarms are defined according to the set point as shown in the diagram below.

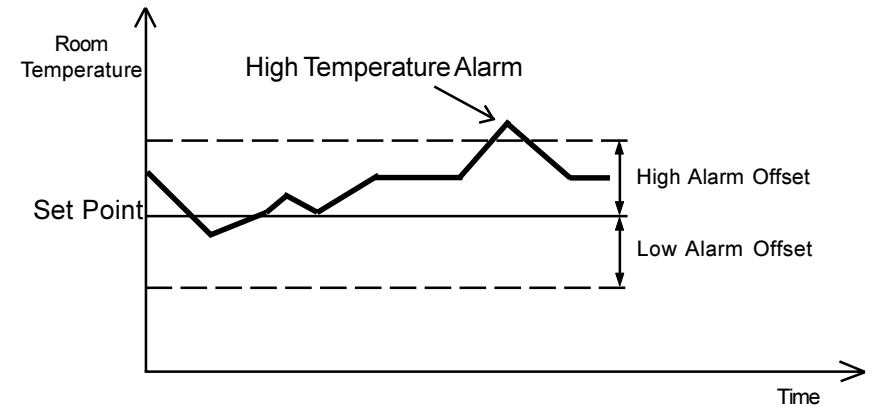

The situation changes for high temperature alarms, however, when the outside temperature is greater than the set point. In this case, the set point is replaced by the outside temperature as the reference point. This means an alarm is set off when the indoor temperature reaches Outside Temperature + High Alarm Offset. Internal switch # 7 must be set to ON to use this feature. A third parameter, called the critical high temperature, is defined to continue monitoring the indoor temperature for high temperatures. When the indoor temperature reaches the critical high temperature (defined as an absolute value), an alarm is set off.

Adjusting the Alarm Settings

The high and low alarm settings are specified as an offset. The high and low alarm offsets range from 0.5°F to 40°F. The critical temperature ranges from -40.0°F to 120.0°F (-40.0°C to 48.9°C).

- Set the selection knob to **ALARM** — **LO / HIGH**. The current low alarm offset is displayed, alternating with the letters "**LO**" and "**OFT**".
- Use the adjustment knob to set the low alarm offset to the desired value.
- Press the push-button. The current high alarm offset is displayed, alternating with the letters "**HI**" and "**OFT**".
- Use the adjustment knob to set the high alarm offset to the desired value.
- Press the push-button. The current critical high temperature is displayed, alternating with the letters "**ABS**".
- Use the adjustment knob to set the critical high temperature to the desired value.

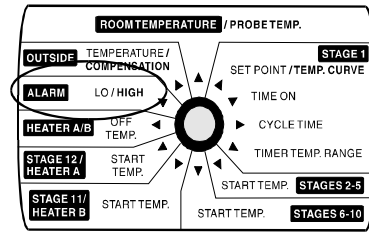

PROBLEM	CAUSE	SOLUTION
There is no display.	The circuit breaker at the service panel is off or tripped.	Correct the problem and reset the circuit breaker.
	The wiring is incorrect.	Correct the wiring.
	The voltage selector switch is in the wrong position.	Set the switch to the correct position.
	The display board interconnect cable is not properly plugged into the power supply board.	Be sure the cable is firmly plugged in.
The display shows "P" when the parameter selection knob is set to OUTSIDE SETTINGS.	The outside probe is connected improperly.	Correct the outside probe connection.
	The outside probe is defective.	Refer to "defective probes"
The display shows "P" when the parameter selection knob is set to ROOM.	A room probe is connected improperly.	Correct the room probe connection.
	A room probe is defective.	Refer to "defective probes"

ST 50210

PROBLEM	CAUSE	SOLUTION
The defective probe pilot light is on.	A room or outside probe is defective.	Refer to "defective probes"
The display shows sudden variations in the room or outside temperature.	<p>A variation in resistance is induced on a probe.</p> <p>There is electrical noise near a probe cable.</p>	<p>Be sure the probes are dry. Locate them away from drafts and sources of radiant heating. Be sure the outside probe is installed correctly. Refer to "Installing the outside probe"</p> <p>Isolate the probe cables from all high voltage sources. Do not route probe cables and other power cables through the same electrical knockout. Do not run probe cables next to other power cables. When crossing other power cables, cross at 90°.</p>
Stage 1 fans do not stop running when the controller is operating in minimum ventilation cycle.	<p>Time off is set to zero.</p> <p>The wiring is incorrect.</p>	<p>Set time off to a value other than zero.</p> <p>Correct the wiring. In particular, make sure two different lines are connected to each motor: line L1 modulated by the controller should be combined with another line (N for 115V or L2 for 230V) to activate the motor. Also, be sure the stage 1 COMMON is supplied by line L1.</p>

ST 50210

PROBLEM	CAUSE	SOLUTION
The mist is not operating as desired.	The mist time on and time off were incorrectly adjusted.	The mist time on and time off are in <u>minutes</u> . Adjust the mist time on and time off correctly.
<p>The cooling fans are not running.</p> <p>or</p> <p>The heaters are not turning on.</p>	<p>The wiring is incorrect.</p> <p>The stage's fuse is open.</p> <p>The display board interconnect cable is not properly plugged into the power supply board.</p> <p>The fan motor or heater is defective.</p> <p>The controller is defective.</p>	<p>Correct the wiring. Be sure two different lines are connected to each fan motor or heater: the controller's output line L1 should be combined with another line (N for 115V or L2 for 230V) to activate the fan motor or heater. Also, be sure the stage's COMMON is supplied by line L1.</p> <p>Replace the fuse.</p> <p>Be sure the cable is firmly plugged in.</p> <p>Check if the motor or heater is defective by connecting it to an alternate power supply. If it still is not operating, replace the motor or heater.</p> <p>Listen to see if there is a clicking sound when the stage or heater pilot light turns on. If there is no clicking sound, contact your distributor to repair the controller.</p>

TECHNICAL SPECIFICATIONS

MASTER BOX

Supply: - 115/230 VAC (-18%, +8%), 50/60 Hz, overload and overvoltage protection fuse F10-1A fast blow.

- 12 VDC for AC back-up supply; can activate stages 1 through 4 if supplied with DC back-up voltage.

Stage 1: ON-OFF output, 115/230 VAC, 50/60 Hz, 30VDC, 6A FAN, 10A RES, fuse F1-10A slow blow.

Stage 2: ON-OFF output, 115/230 VAC, 50/60 Hz, 30VDC, 6A FAN, 10A RES, fuse F2-10A slow blow.

Stage 3: ON-OFF output, 115/230 VAC, 50/60 Hz, 30VDC, 6A FAN, 10A RES, fuse F3-10A slow blow.

Stage 4: ON-OFF output, 115/230 VAC, 50/60 Hz, 30VDC, 6A FAN, 10A RES, fuse F4-10A slow blow.

Alarm: ON-OFF output, 115/230 VAC, 50/60 Hz, 30VDC, 3A FAN, fuse F9-3A slow blow.

Probes: Low voltage (< 5V), isolated from the supply. Operating range: -40.0° to 120.0°F (-40.0° to 48.9°C). Accuracy: 1.8°F (1°C) between 41° and 95°F (5° and 35°C).

Enclosure: ABS, moisture and dust-tight.

ST 50210

SLAVE BOX

Supply: - 115/230 VAC (-18%, +8%), 50/60 Hz, overload and overvoltage protection fuse F10-1A fast blow.

- 12 VDC for AC back-up supply; can activate stages 5 through 12 if supplied with DC back-up voltage.

Stage 5: ON-OFF output, 115/230 VAC, 50/60 Hz, 30VDC, 6A FAN, 10A RES, fuse F1-10A slow blow.

Stage 6: ON-OFF output, 115/230 VAC, 50/60 Hz, 30VDC, 6A FAN, 10A RES, fuse F2-10A slow blow.

Stage 7: ON-OFF output, 115/230 VAC, 50/60 Hz, 30VDC, 6A FAN, 10A RES, fuse F3-10A slow blow.

Stage 8: ON-OFF output, 115/230 VAC, 50/60 Hz, 30VDC, 6A FAN, 10A RES, fuse F4-10A slow blow.

Stage 9: ON-OFF output, 115/230 VAC, 50/60 Hz, 30VDC, 6A FAN, 10A RES, fuse F5-10A slow blow.

Stage 10: ON-OFF output, 115/230 VAC, 50/60 Hz, 30VDC, 6A FAN, 10A RES, fuse F6-10A slow blow.

Stage 11: ON-OFF output, 115/230 VAC, 50/60 Hz, 30VDC, 6A FAN, 10A RES, heating or cooling, fuse F7-10A slow blow.

Stage 12: ON-OFF output, 115/230 VAC, 50/60 Hz, 30VDC, 6A FAN, 10A RES, heating or cooling, fuse F8-10A slow blow.

Enclosure: ABS, moisture and dust-tight.

The room temperature where the controller is located MUST ALWAYS REMAIN BETWEEN 32° AND 104°F (0° AND 40°C).

FACTORY SETTINGS

PARAMETER		FACTORY SETTING	RANGE OF VALUES
Temperature Set Point		75°F(23.9°C)	-40 to 99.9 °F (-40 to 37.7 °C)
Stage 1	Time On	60 seconds	0 to 900 seconds by increments of 15 seconds
	Cycle Time	300 seconds	
	Timer Temp. Range	3°F(1.7°C)	0.5 to 20 °F (0.3 to 11.1 °C)
Stage 2 Starting Temp.		80°F(26.7°C)	0.5 to 20 °F (0.3 to 11.1 °C) from Stage 1 continuous
Stage 3 Starting Temp.		82°F(27.8°C)	0.5 to 20 °F (0.3 to 11.1 °C) from Stage 2 Starting Temp.
Stage 4 Starting Temp.		84°F(28.9°C)	0.5 to 20 °F (0.3 to 11.1 °C) from Stage 3 Starting Temp.
Stage 5 Starting Temp.		86°F(30°C)	0.5 to 20 °F (0.3 to 11.1 °C) from Stage 4 Starting Temp.
Stage 6 Starting Temp.		88°F(31.1°C)	0.5 to 20 °F (0.3 to 11.1 °C) from Stage 5 Starting Temp.
Stage 7 Starting Temp.		90°F(32.2°C)	0.5 to 20 °F (0.3 to 11.1 °C) from Stage 6 Starting Temp.
Stage 8 Starting Temp.		92°F(33.3°C)	0.5 to 20 °F (0.3 to 11.1 °C) from Stage 7 Starting Temp.
Stage 9 Starting Temp.		94°F(34.4°C)	0.5 to 20 °F (0.3 to 11.1 °C) from Stage 8 Starting Temp.
Stage 10 Starting Temp.		96°F(35.6°C)	0.5 to 20 °F (0.3 to 11.1 °C) from Stage 9 Starting Temp.
Stage 11 Starting Temp.		98°F(36.7°C)	0.5 to 20 °F (0.3 to 11.1 °C) from Stage 10 Starting Temp.
Stage 12 Starting Temp.		99°F(37.2°C)	0.5 to 20 °F (0.3 to 11.1 °C) from Stage 11 Starting Temp.

ST 50210

PARAMETER		FACTORY SETTING	RANGE OF VALUES
Mist	Starting Temperature	99°F(37.2°C)	0.5 to 20 °F (0.3 to 11.1 °C) from previous stage's Starting Temp.
	Time On	1 minute	0 to 60 minutes by increments of 1 minute
	Time Off	0 minutes	
Heater Off Temperature		74.5°F(23.6°C)	0.5 to 20 °F (0.3 to 11.1 °C) from Set Point
Alarm	Low Temperature	65°F(18.3°C)	0.5 to 40 °F (0.3 to 22.2°C) from Set Point
	High Temperature	87°F(30.6°C)	
	Critical Temperature	95°F(35°C)	-40 to 120.0 °F (-40 to 48.9 °C)

NOTES:

- i) These initial parameter settings will not be retained in the controller's memory. Each new setting will replace the preceding one.
- ii) If the power supply is cut off, the last parameter settings will be retained in memory until the power is restored.