

User Manual

Farm Premium Controllers



Farm Premium, Premium-P, Premium XL, P-XL

Climate Controllers for Poultry and Pigs

Ag/MIS/UmGB-2224-01/15 Rev. 1.7
P/N: 110476



Farm Premium

User Manual

Revision: N1.7 of 07/2017

Product Software: Version 5.17

This manual for use and maintenance is an integral part of the apparatus together with the attached technical documentation.

This document is destined for the user of the apparatus; it may not be reproduced in whole or in part, committed to computer memory as a file or delivered to third parties without the prior authorization of the assembler of the system.

Munters reserves the right to effect modifications to the apparatus in accordance with technical and legal developments.

1	INTRODUCTION	8
1.1	Disclaimer	8
1.2	Introduction	8
1.3	Notes	8
2	INTRODUCTION TO PRECISION MODE	9
2.1	Front Panel	9
2.1.1	Keypad	10
2.1.2	Relay Switches	10
2.1.3	Hot Keys	11
2.1.4	Main Screen Display	12
2.1.5	Main Menu Icons	14
2.2	Selecting the Mode	14
3	CONTROL MENU	15
3.1	Temperature Curve	15
3.1.1	Temperature Curve Help Set Definitions	16
3.1.2	Radiant Heaters Help Set Definitions	17
3.1.3	Cycle Heaters Set Definitions	18
3.1.4	Variable Heater Help Set Definitions	19
3.1.5	Variable Floor Heater Set Definitions	22
3.2	Introduction to Humidity, Ammonia, and CO2 Treatment	23
3.3	Humidity Treatment	24
3.3.1	Humidity Treatment Help Set Definitions	24
3.4	CO2 Treatment	25
3.4.1	CO2 Treatment Help Set Definitions	26
3.5	Min/Max Level	26
3.5.1	By Day and By Soft Days Curve	27
3.5.2	By Time	27
3.5.3	Day Soft Min.	28
3.5.4	By Weight	28
3.6	Static Pressure	31
3.6.1	Disabling the Static Pressure Sensor	32
3.6.2	Static Pressure Help Set Definitions	33
3.6.3	Multi Stage Tunnel Curtains	33
3.7	Control Mode	34
3.8	System Parameters	34
3.9	Ammonia Treatment	35
3.9.1	Ammonia Treatment Help Set Definitions	36

4 DEVICE MENU 37

4.1	Levels of Ventilation	38
4.1.1	Levels of Ventilation Help Set Definitions	39
4.1.2	Wind Chill	40
4.2	Variable Speed Fan Levels	41
4.3	Vent & Curtain Levels	41
4.3.1	Vent & Curtain Levels Help Set Definitions	42
4.4	Stir Fan Levels	43
4.5	Stir Fan Program	44
4.5.1	Stir Fan Program Help Set Definitions	44
4.6	Cool Pad	46
4.6.1	Cool Pad Help Set Definitions	46
4.7	Foggers	47
4.7.1	Foggers Help Set Definitions	48
4.8	Light	49
4.8.1	Light Help Set Definitions	50
4.9	Water & Feed	51
4.9.1	Control via Time	52
4.9.2	Control via Quantity	52
4.9.3	Water and Feed Help Set Definitions	53
4.10	Extra Systems	54
4.11	Emergency Setting	54
4.11.1	Emergency Setting Help Set Definitions	55
4.12	Water on Demand	56
4.12.1	Relay Control	56
4.12.2	Sensor Control	57
4.12.3	Water on Demand Help Set Definitions	57
4.13	Natural Program	58
4.13.1	How Does Natural Ventilation Work	58
4.13.2	Preliminary Steps	59
4.13.3	Defining Natural Conditions	60
4.13.4	Defining Natural Operation	60
4.13.5	Natural Programming Help Set Definitions	60
4.13.6	Natural Program Hot Screen	61
4.13.7	What Happens When the Controller Transitions?	62
4.14	Feed Scale Program	62
4.14.1	Feed Scale Help Set Definitions	63
4.14.2	Feed Scale Hot Screen	64

5 MANAGE MENU 66

5.1	Inventory	66
-----	-----------	----

5.2	Feed Inventory	67
5.2.1	Feed Inventory Help Set Definitions	68
5.3	Time & Date	68
5.4	Growth Day & Flock/Group	68
5.5	Alarm Setting	69
5.5.1	Alarm Setting Help Set Definitions	70
5.5.2	Prioritizing Alarms	72
5.6	Alarm Reset	73
5.7	Fail Safe Setting	73
5.8	Password	74
5.9	Relay Current	74
5.10	Farm Thermo-5 / Temperature Curve	75
5.10.1	Farm Thermo-5 / Temperature Curve Set Definitions	76

6 SCALE MENU 77

6.1	Scale Layout	77
6.2	General Settings	78
6.2.1	General Settings Help Set Definitions	78
6.3	Bird Scale Setting	79
6.4	Silo Setting	79
6.5	Bird Curve	80
6.5.1	Bird Curve Help Set Definitions	80
6.6	History	80
6.7	Feed Conversion	81
6.8	Test	82
6.9	Calibration	82
6.9.1	Scale Calibration	82
6.9.2	Silo Calibration	83
6.10	Silo / Auger Layout	84

7 HISTORY MENU 85

7.1	Temperature	85
7.2	Humidity	85
7.3	CO2	85
7.4	Water	85
7.5	Feed	86
7.6	Mortality	86
7.7	Heaters	87
7.8	Radiant Heaters	87
7.9	Alarms	87
7.10	Table of Events	87

7.11	History View	87
7.12	Power Consumption	88
7.13	Ammonia History	88
8	TEST MENU	89
8.1	Switches & Relays	89
8.2	Alarm	90
8.3	Analog Sensors	90
8.4	Digital Sensors	91
8.5	Analog Output	91
8.6	Static Pressure	92
8.7	Communication	92
8.8	Hardware Checklist	93
8.9	Emergency Status	93
9	SERVICE MENU	94
9.1	Temperature Calibration	94
9.2	Humidity Calibration	95
9.3	CO2 Sensor	96
9.4	Static Pressure Calibration	96
9.5	Light Sensor Calibration	97
9.6	Feed Calibration	98
9.7	Water Calibration	98
9.8	Ventilation Potentiometer Calibration	98
9.9	Nipple Flushing	99
	9.9.1 Nipple Flushing Help Set Definitions	99
9.10	Feeders & Drinkers	100
	9.10.1 Feeders & Drinkers Help Set Definitions	100
9.11	Save Settings	101
	9.11.1 Saving to a Data Plug	101
	9.11.2 Saving to an SD Card	101
9.12	Load Settings	102
	9.12.1 Loading from a Data Plug	102
	9.12.2 Loading from an SD Card	102
9.13	Current Sense Relay Calibration	103
9.14	Wind Direction Calibration	104
9.15	WOD Calibration	104
	9.15.1 WOD Calibration Help Set Definitions	104
9.16	Ammonia Calibration	104
10	INSTALL MENU	106

10.1	Setup	106
10.1.1	Static Pressure Unit Definition	107
10.2	Relay Layout	107
10.2.1	Output Function List	108
10.2.2	Relay Layout - Help Set Definitions	109
10.3	Analog Sensors	109
10.4	Digital Sensors	110
10.5	Analog Output	110
10.5.1	Light Dimmer, Variable Speed Fan, Variable Heater, Variable Stir Fan Control	111
10.5.2	Vent, Tunnel, and Curtain Analog Output Control	111
10.6	Vent / Curtain Setup	111
10.6.1	Using Time to Calibrate	112
10.6.2	Using a Potentiometer to Calibrate	112
10.6.3	Using Wind Direction	113
10.6.4	Stop Fans	113
10.6.5	Vent/Curtain Help Set Definitions	113
10.7	Temperature Definition	114
10.8	Fan Air Capacity	115
10.9	House Dimensions	115
10.10	Communication	116
11	APPENDIX A: OUTPUT DATA	117
12	APPENDIX B: FARM PREMIUM LAYERS	120
12.1	Layers Main Screen	120
12.2	Layers Vent and Curtain Levels	121
12.2.1	Layer Inlet Control	121
12.2.2	Layer Vent & Curtain (Inlet) levels help set definitions	123
12.3	Layer Dimmers	124
13	APPENDIX C: FARM PREMIUM BREEDERS	125
13.1	Egg Room Setup	125
13.2	Egg Room Water and Feed	127
13.3	Egg Belt Runtime	128
13.4	Egg Room Hot Screen	129
13.5	Egg Room History	129
13.6	Nest Function	129
13.7	Work Room Control	130
13.8	Scale Arm	130
14	WARRANTY	132

1 Introduction

1.1 Disclaimer

Munters reserves the right to make alterations to specifications, quantities, dimensions etc. for production or other reasons, subsequent to publication. The information contained herein has been prepared by qualified experts within Munters. While we believe the information is accurate and complete, we make no warranty or representation for any particular purposes. The information is offered in good faith and with the understanding that any use of the units or accessories in breach of the directions and warnings in this document is at the sole discretion and risk of the user.

1.2 Introduction

Congratulations on your excellent choice of purchasing a Farm Premium Controller!
In order to realize the full benefit from this product it is important that it is installed, commissioned and operated correctly. Before installation or using the fan, this manual should be studied carefully. It is also recommended that it is kept safely for future reference. The manual is intended as a reference for installation, commissioning and day-to-day operation of the Munters Controllers.

1.3 Notes

Date of release: May 2013

Munters cannot guarantee to inform users about the changes or to distribute new manuals to them.

All rights reserved. No part of this manual may be reproduced in any manner whatsoever without the expressed written permission of Munters. The contents of this manual are subject to change without notice.

2 Introduction to Precision Mode

This document describes the **Farm Premium** Precision Mode Broilers, Layers, and Pigs operation.

Computerized Electronic Controllers such as the Farm Premium advance the producer's ability to grow high quality poultry or eggs by accurately controlling the environment. Instead of struggling with individual thermostats for heat zones and ventilation, Farm Premium brings them all together into one convenient place with great accuracy. In Precision Mode, the Farm Premium optimizes and precisely applies your equipment and energy sources to most benefit from the accuracy of your computer and sensors.

Precision Mode is characterized by its large number of features that enable system setups that meet your exact requirements. The Farm Premium precisely coordinates ventilation levels, providing the optimal amount of fresh air balanced with heating costs. The light and feed clocks enable efficient feed distribution. Besides advanced cooling pad methods, you benefit from superior stir fan programs to recover ceiling heat and other features. Taken together, Precision Mode's numerous features enable significant profitability improvement.

Farm Premium provides a variety of management and history utilities. You can choose from simple overviews, or fully detailed by the *minute* records of minimum, maximum and average temperatures for each individual sensor. The unique **Table of Events** records the moment of every significant action taken by the Farm Premium and, optionally, its operator.

- Front Panel, page 9
- Selecting the Mode, page 14

2.1 Front Panel

Figure 1 shows the Farm Premium-P XL front panel and its elements. All controllers have similar elements.

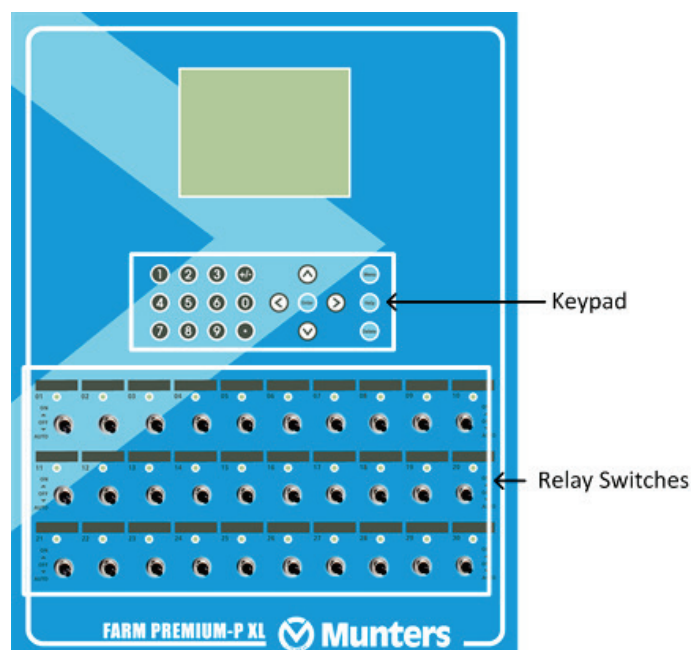

Figure 1: Farm Premium-P XL Front Panel

The following sections detail the front panel elements.

- Keypad
- Relay Switches
- Hot Keys
- Main Screen Display
- Main Menu Icons

2.1.1 KEYPAD

MENU Enter main menu, also acts as "ESC" or "Back" key

HELP Access help screens and graphs

DELETE Erase typing mistakes

OK Enter menus, values, open windows

↑ Scroll up, down, left and right

← OK →

↓

Keypad Enter values, select options and make selections

+/- Toggle between positive and negative values and mark check boxes.

2.1.2 RELAY SWITCHES



Figure 2: Standard Relay Switches

Figure 2 illustrates a row of standard relay switches. Set each relay to:

- **On:** Always on
- **Off:** Always off

- **Auto:** The relay operates according to its set parameters.



Figure 3: Emergency Relay Switches

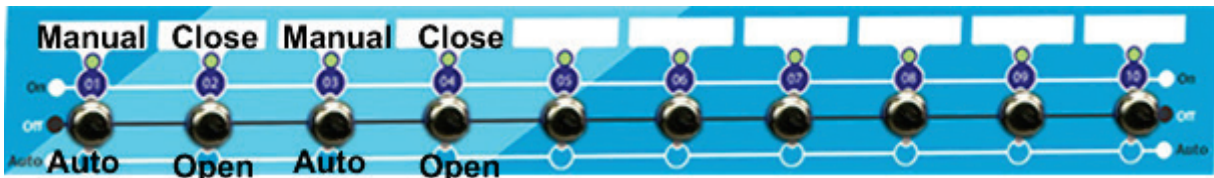

Figure 4: Winch Switches

2.1.3 HOT KEYS

Many of the keys serve as shortcuts to hot screens (information screens). Press these keys when the controller displays the Main Screen.

- | | |
|------|--|
| HELP | Software version |
| 1 | Return to standard main screen |
| 2 | Temperature, humidity status, and wind chill temperature
<i>NOTE: If two humidity sensors are installed, Hot Screen 2 displays their average.</i> |
| 3 | Curve status |
| 4 | Curtain, tunnel, vent, and attic opening positions |
| 5 | Bird Scale
Natural Program Status. Refer to Natural Program Hot Screen, page 61) |
| 6 | Light status |
| 7 | Analog output status |
| 8 | Temperature sensors |
| 9 | <ul style="list-style-type: none"> • Silo status |



Scan through Hot Screens for five seconds each



Water and Feed status



Air status (refer page 31 for details on this screen) (Broilers/Layers mode only)



Zone Inlet Position: View the inlet(s) target position, actual position, and number of steps (refer to page 120 for details) (Layers)



Stir fans status



Increase/ decrease offset from temperature setting from the standard display only (hold both keys) - defined in the [TEMPERATURE CURVE HELP | SET](#)



2.1.4 MAIN SCREEN DISPLAY

The main screen display depends on the operating mode.

NOTE: When in Layer Mode, refer to Layers Main Screen, page 120.

SENSORS		AV. TEMP.	ACTIVE	
Temp1	37.9°	27.5°	Heat	1
Temp2	16.2°		Heat. Hi	1
Temp3	28.2°	STATUS		
E. Tmp1	28.8°	08:53:06	Tun. Fan	
E. Tmp2	28.4°	Day: 2	Exh. Fan	
Press.	23	Set: 25.0	Stir	
Out T.	23.9°	Level: 3	Cool P.	
Hum. In	58.7%	Min. Vent	Fogger	
Hum. Out	61.9%	FanOff: 176	Curt. 1	100%
Weight	0.000		Curt. 2	100%
Weights	0		Feeder	
4 MESSAGES			Auger	
(2) Low Feed At Bin 2			Valve	
			Alarm	

1. **Sensors:** Displays individual sensor readings. Temperature sensors marked with dark squares form the current average temperature.

- **Filled square:** Indicates the sensor participates in the average calculation.
- **Empty square:** Indicates the sensor does not participate in the average calculation.

SENSORS	
Temp1	37.9°
Temp2	16.2°
Temp3	28.2°
E. Tmp1	28.8°
E. Tmp2	28.4°
Press.	23
Out T.	23.9°
Hum. In	58.7%
Hum. Out	61.9%
Weight	0.000
Weights	0

NOTE: Go to Table 1: Sensor Readings page 117, to view all the possible sensors.

2. **Av. Temp:** Reports the current average temperature. This example is in Celsius.

Av. Temp
27.5°

3. **Active:** Displays the output relay list. The filled black boxes indicate active outputs. Controller also informs the position of inlets and curtains, as well as the number of operating heaters or fans.

ACTIVE	
Heat	1
Heat. Hi	1
Tun. Fan	
Exh. Fan	
Stir	
Cool P.	
Fogger	
Curt. 1	100%
Curt. 2	100%
Feeder	
Auger	
Valve	

NOTE: Go to Table 2: Output List (Active), page 117 to view all the available readings (ACTIVE).

NOTE: The **ACTIVE** screen shows rectangular markers by the outputs. Filled rectangles indicate operating outputs; empty rectangles indicate outputs that are off.

4. **Status:** Provides important general information such as the time and ventilation mode.

EXAMPLE

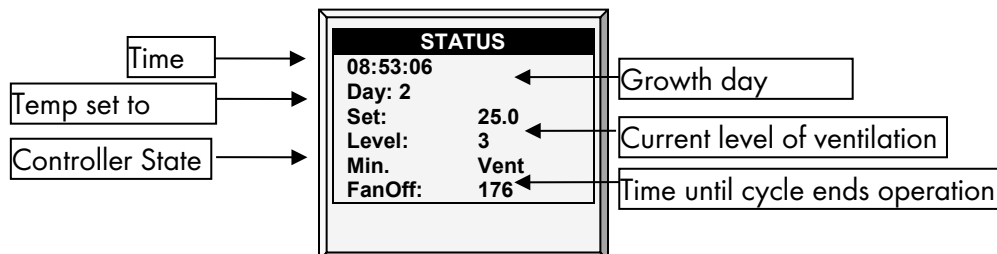

NOTE: Go to Table 1: Sensor Readings, page 117 to view all the available readings.

5. **Messages:** Displays important messages/alarms. The title bar displays the number of important messages, and if there are several messages, they each appear in turn.

4 MESSAGES
(2) Low Feed At Bin 2

2.1.5 MAIN MENU ICONS

- To enter the Main Menu screen, press **Menu**.
- To select an option, press **Enter**.

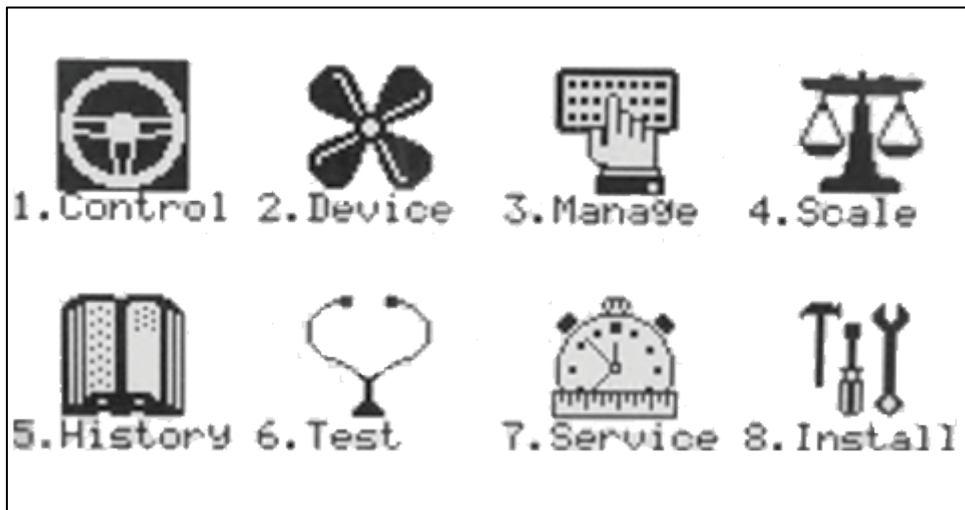

1. Control temperature, humidity, ventilation, static pressure and system parameters.
2. Define equipment settings
3. Manage inventory, livestock, and alarm/password settings.
4. Set, calibrate and test Bird Scale and Silo Scale.

NOTE: *Pig Mode has a limited number of functions in this menu.*

5. View history of all controller functions.
6. Test to see switches, relays, communication, and alarms are functioning properly.
7. Calibrate temperature, humidity, ventilation, static pressure, feed, water, read/save to plug.
8. Install sensors, devices, communication, etc.

2.2 Selecting the Mode

Farm Premium runs in four modes: Broiler, Layer, Breeders, and Pigs.

To select the mode:

1. Disconnect the power cable from the power source.
2. Reapply power while pressing **Delete**. The Cold Start screen appears.
3. Select **Yes**. The Choose Controller Type appears.
4. Select the required mode.
5. Press **Enter**.

NOTE: *The manual is based on the Broiler Mode. Functions that are unique to Layers and Breeders and described in separate appendixes. Except for a few functions dealing with scales, Pig Mode supports the vast majority of functions seen in Broiler Mode. Pig Mode has some different terminology (for example herd instead of flocks).*

- Appendix B: Farm Premium Layers
- Appendix C: Farm Premium Breeders

3 Control Menu

The following sections detail:

- Temperature Curve, page 15
- Humidity Treatment, page 24
- CO2 Treatment, page 25
- Min/Max Level, page 26
- Static Pressure, page 31
- Control Mode, page 34
- System Parameters, page 34
- Ammonia Treatment, page 35

CONTROL	
1.	TEMPERATURE CURVE
2.	HUMIDITY TREATMENT
3.	CO2 TREATMENT
4.	MIN/MAX LEVEL
5.	STATIC PRESSURE
6.	CONTROL MODE
7.	SYSTEM PARAMETERS
8.	AMMONIA TREATMENT

3.1 Temperature Curve

This screen sets the temperature targets according to the bird/pig age.

TEMPERATURE CURVE						
Day	Target	Heat	Tunnel	Alarm		T.Hi
				Low	High	
1	89.0	89.0	100.0	84.0	102.0	103
2	89.0	89.0	99.0	84.0	102.0	103
3	87.0	87.0	97.0	82.0	95.0	103
7	84.0	83.0	91.0	80.0	95.0	103
15	82.0	81.0	89.0	78.0	93.0	103
21	79.0	78.0	86.0	75.0	90.0	103
28	76.0	74.0	81.0	71.0	87.0	103
35	72.0	70.0	77.0	67.0	84.0	103
42	70.0	68.0	75.0	63.0	83.0	103
48	68.0	66.0	73.0	60.0	83.0	103

1. In *Install > Analog Sensors* (refer to Analog Sensors, page 109), designate the required number of sensors as temperature sensors. When using more than one sensor, Farm Premium begins treatments based on the average.
2. If required, go to *Service > Temperature Calibration*, calibrate the sensors (refer to Temperature Calibration, page 94).
3. In *Install > Temperature Definition* (refer to Temperature Definition, page 114), assign specific sensors brood setups, heater zones, and devices. If a zone does not have an assigned sensors, calculations are based on the current average temperature.
4. In *Control > Temperature Curve*, define the required target temperature curve
 - Set up to 20 lines, 999 growth days. When a curve is not required (for example when growing layers), enter temperatures in the first line only.
 - **Define:**
 - **Day:** Set the growth day. You can program negative growth days up to -2 for pre-warming. To enter a negative growth day, type the day number followed by the ± key.

- **Target:** Set the desired temperature.
- **Heat:** Set the temperature to stop heat.
- **Tunnel:** Set the temperature for tunnel ventilation to begin.
- **Alarm Low & High:** Set average temperature alarm limits.
- **Floor heat:** Set the temperature upon which the floor heat curve is based. Refer to Variable Floor Heater | Set Definitions, page 22.
- **T.Hi:** Set a high temperature alarm for Tunnel mode.

5. In Manage > Alarm Setting, set the Sensor Alarm (page 69).

NOTE: Only Pig Mode supports variable floor heaters. To enable this function define an analog output as a floor heater (refer to Analog Output, page 110).

6. If required set the:

- Temperature Curve Help | Set Definitions, page 16
- Radiant Heaters Help | Set Definitions, page 17
- Variable Heater Help | Set Definitions, page 19
- Variable Floor Heater | Set Definitions, page 22
- Heat Cycle | Set Definitions, page **Error! Bookmark not defined.**

3.1.1 TEMPERATURE CURVE HELP | SET DEFINITIONS

② While viewing the Temperature Curve menu: Press **HELP**, select **SET**, and press **ENTER**.

SYSTEM PARAMETERS	
TEMPERATURE CURVE	
Temperature Curve Offset	0.0
Set Temp. Change Reminder (Diff)	3.0
Target Temp. Band	1.5
Heater Temp. Band	1.0
Cool Down Factor (%)	15
Cool Down Fast Response (Deg.)	3.0
Min Vent Below Heat Temp By: ►	ZONE
Non Brood Area Diff. From Heat	-3.0

- **Temperature Curve Offset:** Adjusts all temperature curves by this amount. You can use this to temporarily adjust all temperatures up or down for special circumstances. The curve appears in the [Status Window](#), and you can use the [ENTER and Up](#) or [ENTER and Down](#) hot key combinations to change the offset.
- **Set Temp. Change Reminder (Diff):** Sets the change in set temperature that triggers a reminder for you to set backup thermostats. Often producers forget to set backup thermostats as their birds grow from baby chicks to market age, so the Farm Premium reminds you. When you press Enter to acknowledge the reminder, the Farm Premium logs it in the Table of Events.
- **Target Temp. Band:** The size of the target temperature zone. This "Happy Zone" is between Target Temperature and (Target Temperature + Band).
- **Heater Temp. Band:** Heaters turn on at 'Band' degrees below Heat, and turn off at the Heat Temperature.

NOTE: Heaters operate at minimum level only; however, Radiant Heaters can operate at any temperature or level below Tunnel.

- **Cool Down Factor (%):** Minimum percentage correction towards target during each increase [ventilation level delay](#). If average temperature does not improve by this amount, the Farm Premium increases ventilation by one level.

- **Cool Down Fast Response (Deg.):** Set a limit to the maximum degrees per minute of cooling. If Average Temperature drops more than this in one minute, the Farm Premium decreases ventilation one level to avoid overshooting.

NOTE: Avoid making this parameter too small or the normal temperature variation caused by timer fans reduces the ventilation level.

- **Min Vent Below Heat Temp By:** Tells controller to go directly to Min Level in some cases. Select from the following choices:
 - None: Operate by the normal level decrease time delay rule.
 - Zone: Go directly to minimum level if any active temperature sensor reaches heat temperature.
 - Avg.: Go directly to minimum level if the average temperature reaches heat temperature.
- **Non Brood Area Diff. From Heat:** Set differential temperature for non-brood heaters. You normally use this to set temperatures in unoccupied areas (poultry modes only).

NOTE: When set at -99 °F the heaters are effectively disabled, since it will probably never go to 99° F below the heater temperature. Putting this parameter at 0° sets the non-brood areas to the heater temperature.

3.1.2 RADIANT HEATERS HELP | SET DEFINITIONS

SYSTEM PARAMETERS	
TEMPERATURE CURVE	
Target Temp. Band	1.5
Heater Temp. Band	1.0
Cool Down Factor (%)	15
Cool Down Fast Response (Deg.)	3.0
Min Vent Below Heat Temp By: ▶	ZONE
Non Brood Area Diff. From Heat	-3.0
CYCLE HEATER	
Low Heat Differential	1.0
High Heat Differential	8.0
Minimum On Time	30
RADIANT HEATERS	
Rad. Low -Diff from Heat Set	0.0
Rad. High -Diff (Below Low Set)	1.0
Radiant Ignition Time (sec)	30

To configure the radiant heaters:

1. In *Installation > Relay Layout* define at least one relay as a radiant heater (page 107).
2. Configure the following parameters:
 - Radiant Low - Differential from Heat Set: Set degree of difference from Heat for LOW Radiant Heaters to begin working. This differential can be positive or negative. (default: 2.0)
 - Radiant High - Differential (Below Low Set): Set number of degrees below Radiant Low Heaters for HIGH Radiant Heaters to begin working (default: 1.0). To ensure proper heater ignition, Radiant High Heaters remain on for the Radiant Ignition Time along with the Radiant Low Heaters.
 - Radiant Ignition Time (sec): Set number of seconds to power radiant ignition (default: 30).

NOTE: The Heater Temperature Band applies to radiant heaters as well. For example, if the Heat Temperature is 80° F and the Heater Temperature Band is 1° F, then heaters turn on at 79° F and off at 80° F. If the Radiant Low Differential is at 2.0° F, then radiant heaters turn off at 82° F, and on 1° F below that at 81° F. However, a Radiant High Heater turns on regardless of its temperature setting for the Radiant Ignition Time whenever the corresponding Radiant Low Heater turns on. This feature ensures proper flame ignition.

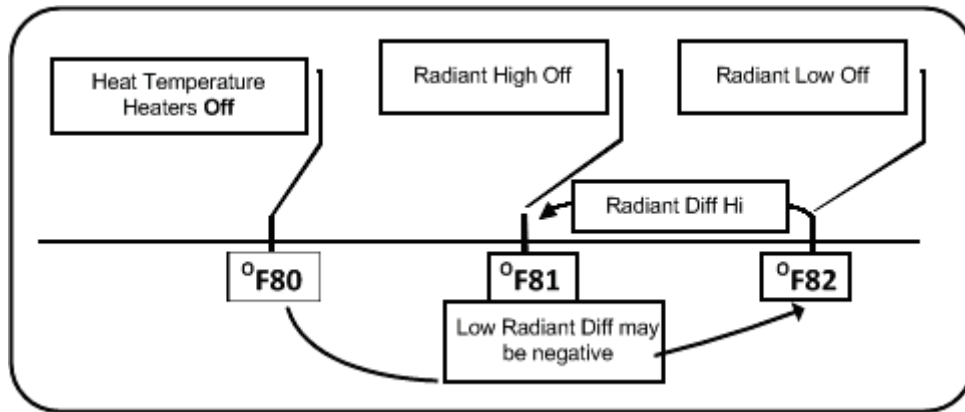

Figure 5: Radiant Heater Differentials

3.1.3 CYCLE HEATERS | SET DEFINITIONS

Heat Cycle means providing heat in conjunction with the ventilation system during minimum ventilation cycles, **using heaters and fans connected to relays**. When enabled, heaters operate during the fans' cycle off time (as defined in the Levels of Ventilation Cycle Timer On and Off parameters). How does it work?

Between the Heat Temperature and the differential temperature, heaters do not operate. When the temperature goes below the Heat Off temperature minus the Low Heat Differential:

- Heaters begin to operate when the exhaust or tunnel fans are off. Heaters operate for the Minimum On Time.
- If the temperature continues to drop, heaters operate for longer periods of time, up to the Maximum On Time (defined in Levels of Ventilation).
- Farm Premium automatically generates a curve.

In this example:

- Temperature Curve Heat Off is 78°.
- Low Heat Differential is 1°.
- High Heat Differential is 8°.
- Minimum On time is 30 seconds.
- Cycle Off time is 270 seconds.

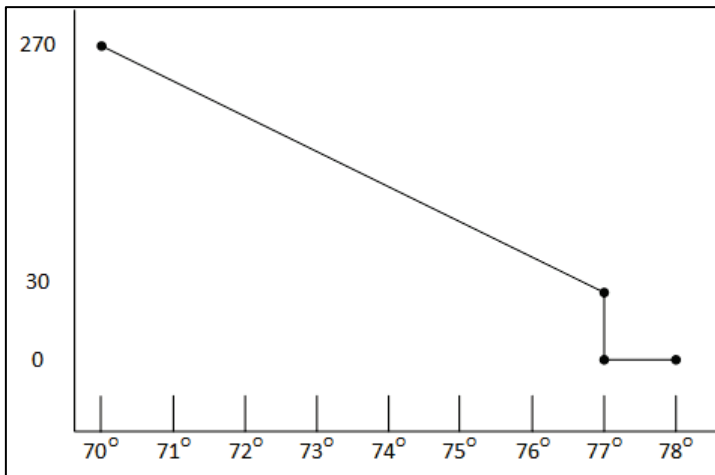

1. Define the required number of heater and exhaust and/or tunnel relays (Relay Layout, page 107).
2. In Control > Control Mode, set the Heater Cycle to Yes.
3. In Control > Temperature Curve > Help, scroll to Cycle Heater.
4. Define:
 - Low Heat Differential: The differential below the Heat Off temperature, at which heating begins and runs for the minimum amount of time.
 - High Heat Differential: The differential below the Heat Off temperature, at which heating runs for the maximum amount of time

Minimum ON Time: Minimum heating time when the exhaust or tunnel fans are off.

3.1.4 VARIABLE HEATER HELP | SET DEFINITIONS

The Farm Premium Controller enables configuring up to eight variable heaters. The heater output changes according to the output of a 0 - 10 VDC device.

➤ Install at least one analog output card.

To configure the variable heaters:

1. In *Installation > Analog Output* configure:
 - a. up to eight analog outputs as variable heaters
 - b. the minimum and maximum voltage output for each heater

ANALOG OUTPUT			
Out No.	Output Function	Min V.Out	Max V. Out
1	Var. Heater 1	1.0	10.0
2	Var. Heater 2	1.0	10.0
3	Var. Heater 3	1.0	10.0
4	Var. Heater 4	1.0	10.0
5	Var. Heater 5	1.0	10.0
6	Var. Heater 6	1.0	10.0
7	Var. Heater 7	1.0	10.0
8	Var. Heater 8	1.0	10.0

2. In Control > Control Mode > Analog Heat Mode, define the mode.
 - Linear Heat:
 - Proportional Heat
 - Linear Valve
3. In Control > Temperature Curve > Help, define the parameters for each mode.

3.1.4.1 Linear Heat

When Linear Mode is enabled:

- Between the Heat Temperature and the Target temperature, heaters do not operate (meaning, the output voltage is 0).
- Between the Heat Temperature and the Low Difference Below Heat, heaters operate at the minimum voltage output.
- If the temperature continues to drop, the voltage output increases until it reaches the maximum voltage output at the High Difference below Heat.

In this example:

- Target Temperature is 80°
- Temperature Curve Heat Off is 78°.
- Low Heat Differential is 1°.
- High Heat Differential is 8°.
- If the temperature is between 77° to 78°, the output voltage is the minimum voltage defined in Installation > Analog Output (1 volt in this example).
- If the temperature continues to drop, the output voltage increases until it reaches the maximum voltage defined in Installation > Analog Output. Output increases or decreases to keep the temperature within the Target Temperature and Heat Off band.

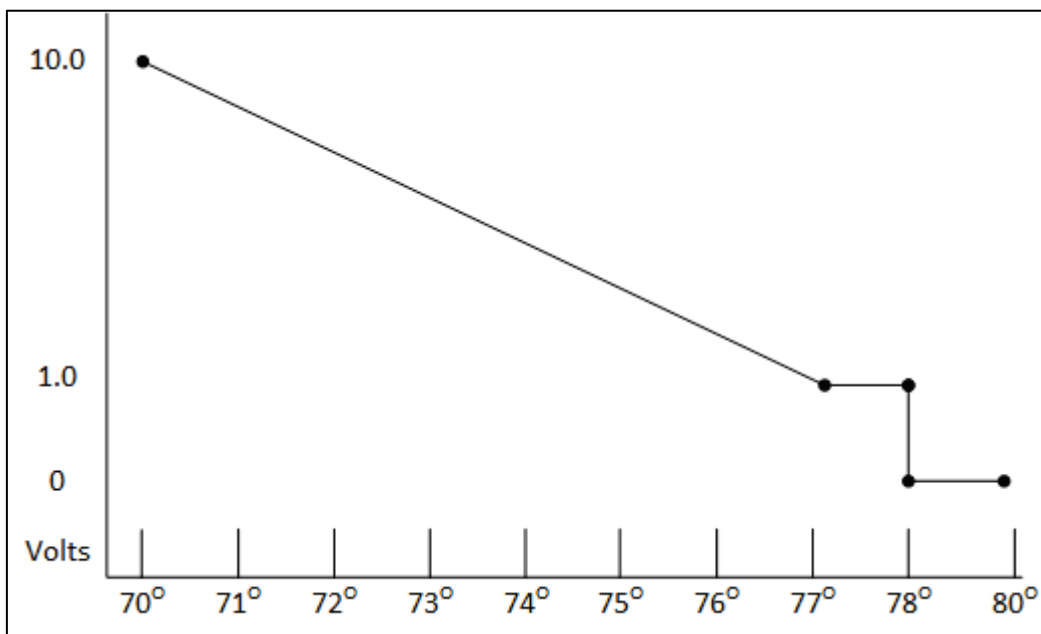

SYSTEM PARAMETERS	
RADIANT HEATERS	
Rad. Low -Diff from Heat Set	0.0
Rad. High -Diff (Below Low Set)	1.0
Radiant Ignition Time (sec)	30
VARIABLE HEATER	
Low Diff Below Heat	1.0
High Diff Below Heat	8.0

- Define the parameters:
 - **Low Difference Below Heat:** Temperature difference between the Heat Off parameter at which the variable heater begins to function.

- **High Difference Below Heat:** Temperature at which the heater begins to operate at maximum output.

3.1.4.2 Proportional Heat

Proportional Heat works in manner similar to Linear Mode. The difference is that Proportional Heat features a delay time.

- When the temperature falls below the user-defined point, the heaters begin operating at their minimum output.
- After the response time passes, Farm Premium checks the temperature. If it is still below the defined point, Farm Premium increases the voltage by a certain amount (this amount of the increase cannot be changed).
- After the response time passes, the process is repeated until heaters operate at their maximum output.

SYSTEM PARAMETERS	
RADIANT HEATERS	
Rad. Low –Diff from Heat Set	0.0
Rad. High –Diff (Below Low Set)	1.0
Radiant Ignition Time (sec)	30
VARIABLE HEATER	
Diff Above Heat to Stop Heater	1.0
High Diff Below Heat	8.0
Response Time (seconds)	15

- Define the parameters.
 - **Difference Above Heat to Stop Heater:** Differential from target temperature at which the heater runs at minimal input
 - **High Difference Below Heat:** High Difference Below Heat: Temperature at which the heater begins to operate at maximum output
 - **Response Time (seconds):** Amount of time before the controller begins to change the ventilation.

3.1.4.3 Linear Valve

SYSTEM PARAMETERS	
RADIANT HEATERS	
Rad. Low –Diff from Heat Set	0.0
Rad. High –Diff (Below Low Set)	1.0
Radiant Ignition Time (sec)	30
VARIABLE HEATER	
Low Diff Below Heat	1.0
High Diff Below Heat	8.0

Linear Valve enables defining that variable heater input voltage is always equal to or above the minimum input defined in Installation > Analog Sensors..

When the Analog Heat Mode is defined as having Linear Valve control, there is always a minimal voltage input. Therefore, if the minimum voltage is 1 volts:

- The voltage range is from 1 to 10 volts
 - this corresponds to 10% at 1V and 100% at 10V

- interpolation inside the band
- There is 0% voltage when the target temperature is reached.

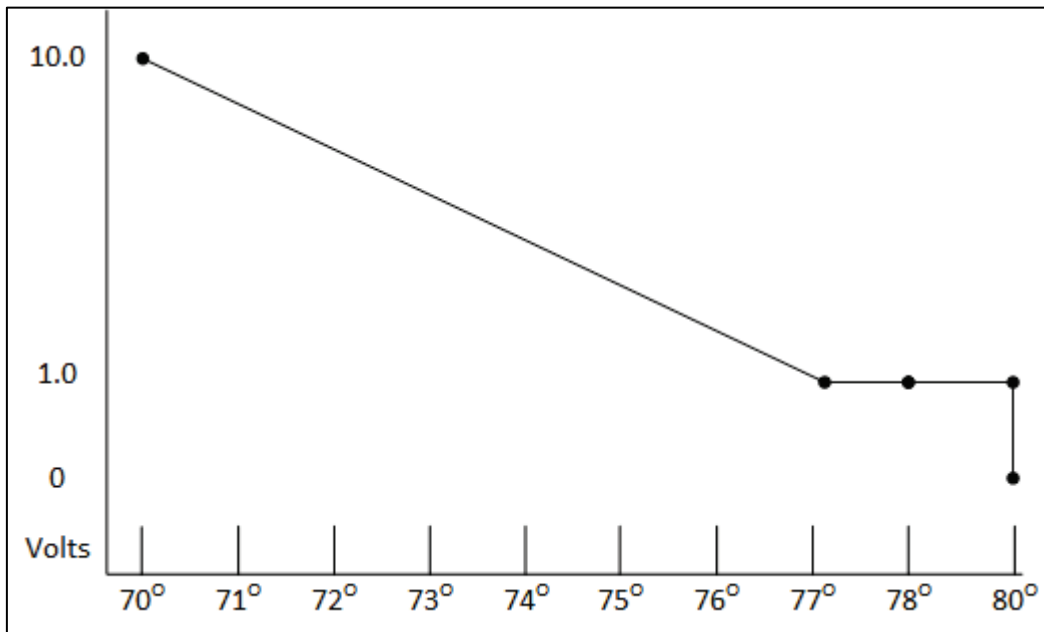

- Define.
 - **Difference Above Heat to Stop Heater:** Differential from target temperature at which the heater runs at minimal input
 - **High Difference Below Heat:** High Difference Below Heat: Temperature at which the heater begins to operate at maximum output.

3.1.5 VARIABLE FLOOR HEATER | SET DEFINITIONS

SYSTEM PARAMETERS	
RADIANT HEATERS	
Rad. Low -Diff from Heat Set	0.0
Rad. High -Diff (Below Low Set)	1.0
Radiant Ignition Time (sec)	30
VARIABLE HEATER	
Low Diff Below Heat Tmp.	0.5
High Diff Below Heat Tmp.	4.5
VARIABLE FLOOR HEATER	
Low Diff Below Heat Tmp.	0.5
High Diff Below Heat Tmp.	4.5

Farm Premium Controllers enable configuring up to two variable floor heaters. The output of the heaters changes as the temperature increases or decreases.

➡ **Install at least one analog output card.**

To configure the variable floor heaters:

1. In *Installation > Analog Output* configure:
 - a. up to two analog outputs as variable heaters
 - b. the minimum and maximum voltage output for each heater

ANALOG OUTPUT			
Out No.	Output Function	Min V.Out	Max V. Out
1	Var. Heater 1	1.0	10.0
2	Var. Heater 2	1.0	10.0
3	Floor Heater 1	1.0	10.0
4	Floor Heater 2	1.0	10.0
5	Var. Heater 3	1.0	10.0
6	Var. Heater 4	1.0	10.0
7	Var. Heater 5	1.0	10.0
8	Var. Heater 6	1.0	10.0

2. In *Control > Temperature Curve > Help*, scroll down to Variable Floor Heater.
 3. Set the response time (amount of time before the controller begins to change the ventilation).
 4. Variable heat parameters are dependent on the mode employed:
 - Linear Heat
 - Proportional Heat
- Refer to the above sections for further information on these modes.

3.2 Introduction to Humidity, Ammonia, and CO2 Treatment

Farm Premium provides various options to controlling the humidity, CO2, and ammonia levels.

- **None:** No treatment is provided.
- **Level:** Ventilation levels increase for a designated amount of time.
- **Tunnel or exhaust fan:** A designated fan turns on for a designated amount of time. The amount of air blown into the house is greater than that provided by an increase in ventilation level.
- **Increase in air / weight:** The total amount of air that fans need to provide increases by a user defined amount. Fan stay on until CO2, humidity, or ammonia levels fall to their defined levels. This option is only available when using Minimum Ventilation by Weight.
- **Humidity treatment by heat:** In cold air situations, heaters can be turned on to lower the relative humidity.

If there is a contradiction between CO2, humidity, and ammonia treatments:

- Ammonia treatment has priority over CO2 treatment.
- CO2 treatment has priority over humidity treatment.
- Increase in air / weight has priority over other treatments.
- Humidity treatment by heat takes priority over increasing the ventilation.

3.3 Humidity Treatment

Humidity treatment forces an increase in ventilation level when the humidity is too high. It holds the increase for 'Duration Seconds', and checks back after 'Interval Minutes' for another increase. After the duration, the ventilation level comes back down automatically.

HUMIDITY TREATMENT			
Day	Humidity	Delay (Min)	Duration (sec.)
1	70	10	130
7	75	7	150
14	80	5	180
0	0	0	0
0	0	0	0
0	0	0	0
0	0	0	0
0	0	0	0
0	0	0	0

1. In *Install > Analog Sensors* (refer to Analog Sensors, page 109), designate up one or two sensors as indoor humidity sensors (outdoor sensor is for information only). When using more than one sensor, Farm Premium begins treatments based on the average.
2. If required, go to *Service > Humidity Calibration*, and calibrate the sensors (refer to Humidity Calibration, page 95).
3. In *Control > Humidity Treatment* set the parameters as required.
 - **Day:** Growth day. Can set multiple programs for same day (Maximum number of programs: 20)
 - **Humidity:** Humidity at which to begin treatment
 - **Delay Minute:** Amount of time the controller pauses before ventilating
 - **Duration Seconds:** Number of seconds the controller maintains the increased level of ventilation
4. Set the Humidity Sensor Alarm (page 72).

3.3.1 HUMIDITY TREATMENT HELP | SET DEFINITIONS

- ① While viewing the Humidity Treatment menu: Press **HELP**, select **SET**, and press **ENTER**.

HUMIDITY TREATMENT	
Humidity Band (%)	5.0
Humidity Treatment below Heat	YES
Humidity Treatment By	Exh 6
HUMIDITY TREATMENT BY HEATERS	
Humidity Treatment by Heater	YES
Outside Temp Treat by Heaters	-18.0
Diff to Stop Treatment by Heaters	3.6

- **Humidity Band (%):** Hysteresis band for Humidity Treatment.
- **Humidity Treatment below Heat:** Select **YES** or **NO** for allowing Humidity Treatment when heaters are operating (set in [Control | Temperature Curve](#)).
- **Humidity Treatment By:** This parameter designates the method used when humidity or CO2 treatment begins. Normally, this parameter is relevant only when minimum ventilation is running. When a treatment is required, select one the method to be employed:
 - **Level:** Increases the ventilation level when a treatment is required.

NOTE: When employing Ventilation by Weight (refer to page 28), the controller increases the cycle time or the level, depending on the particular settings.

- Exhaust: Designate a specific exhaust fan (press a number key to select the fan).
- Tunnel: Designate a specific tunnel (press a number key to select the fan).
- None: Disables the treatment.

➤ **To enable the exhaust/tunnel options, in *Installation > Relay Outlet* or *Installation > Analog Output*, designate a relay/variable device as a tunnel or exhaust fan.**

- Humidity Treatment by Heaters: This parameter enables using the heaters to lower the relative humidity. If enabled, define:
 - Outside Temp Treat by Heaters: Heaters handle humidity treatment when the **outside** temperature is lower than the target temperature by this amount.
 - Diff to Stop Treatment by Heaters: Heaters cease the humidity treatment if the **inside** temperature is lower (or higher) than the target temperature by this amount. This number can be positive or negative.

➤ **Humidity Treatment by Heater requires designating at least one temperature sensor as an outside temperature sensor (refer to Temperature Definition, page Error! Bookmark not defined.).**

NOTE: If the heaters are operating because of the interior temperature, Humidity Treatment by Heater is disabled.

NOTE: Broiler and Breeder Modes support Humidity Treatment by Heaters.

3.4 CO2 Treatment

CO2 treatment forces an increase in ventilation level when the CO2 level is too high. It holds the increase for 'Delay Seconds', and checks back after 'Interval Minutes' for another increase. After the duration, the ventilation level may come back down automatically. If during treatment, the CO2 level drops below the **Stop Value** parameter, the ventilation level automatically returns to that level used before CO2 treatment was initiated.

CO2 TREATMENT				
Day	Start Value	Stop Value	Delay (Sec)	Duration Sec.
1	3000	2500	120	130
7	2700	2200	120	150
14	2500	2000	90	180
0	0	0	0	0
0	0	0	0	0
0	0	0	0	0
0	0	0	0	0
0	0	0	0	0
0	0	0	0	0
0	0	0	0	0

1. In *Install > Analog Sensors* (refer to Analog Sensors, page 109), designate one sensor as a CO2 sensor.
2. If required, go to *Service > CO2 Calibration* and calibrate the sensors (refer to CO2 Sensor, page 96).
3. In *Control > CO2 Treatment* set the parameters as required.
 - **Day:** Growth day. You can set multiple programs for same day (maximum number of programs: 20)

- **Start Value:** CO2 value at which to begin treatment
- **Stop Value:** CO2 value at which to end treatment
- **Delay (Sec):** Number of seconds the controller pauses before ventilating
- **Duration (Sec):** Number of seconds the controller maintains the increased level of ventilation

4. Set the CO2 Sensor Alarm (page 72).

3.4.1 CO2 TREATMENT HELP | SET DEFINITIONS

② While viewing the CO2 Treatment menu: Press **HELP**, select **SET**, and press **ENTER**.

SYSTEM PARAMETERS	
CO2 TREATMENT	
CO2 Treatment Below Heat	NO
CO2 Treatment By	Exh 6

- **CO2 Treatment below Heat:** Select **YES** or **NO** to enable CO2 treatment when heaters are operating (set in [Control | Temperature Curve](#)).
- **CO2 Treatment By:** This parameter designates the method used when humidity or CO2 treatment begins. Normally, this parameter is relevant only when minimum ventilation is running. When a treatment is required, select one the method to be employed:
 - Level: Increases the ventilation level when a treatment is required.

NOTE: When employing Ventilation by Weight (refer to page 28), the controller increases the cycle time or the level, depending on the particular settings.

- Exhaust: Designate a specific exhaust fan (press a number key to select the fan).
- Tunnel: Designate a specific tunnel (press a number key to select the fan).
- None: Disables the treatment.

➡ To enable the exhaust/tunnel options, in *Installation > Relay Outlet* or *Installation > Analog Output*, designate a relay/variable device as a tunnel or exhaust fan.

- **CO2 Treatment by Heaters:** This parameter enables running the heaters in situations where the CO2 level is high. Typically this can happen in cold temperatures when CO2 is produced by the heaters. By increasing the heat in the house, ventilation can then be increased. If enabled, define:
 - Outside Temp Treat by Heaters: Heaters handle CO2 treatment when the **outside** temperature is lower than the target temperature by this amount.
 - Diff to Stop Treatment by Heaters: Heaters cease the CO2 treatment if the **inside** temperture is lower (or higher) than the target temperature by this amount. This number can be positive or negative.

➡ **CO2 Treatment by Heater** requires designating at least one temperature sensor as an outside temperature sensor (refer to Temperature Definition, page Error! Bookmark not defined.).

NOTE: If the heaters are operating because of the interior temperature only, CO2 Treatment by Heater is disabled.

3.5 Min/Max Level

- **IMPORTANT:** Before setting Min/Max level, go through and set up the Device Settings, especially the [ventilation levels](#).

Once you have entered the ventilation levels, use the Min/Max to select the range of levels to apply to your situation. Typically, Farm Premium increases the minimum ventilation level as litter conditions deteriorate and the birds require greater amounts of fresh air. You can also restrict the maximum level to prevent excess airflow on young birds.

- Go to *Control > Control Mode* to select the minimum ventilation method:

- By Day and By Soft Days Curve
- By Time
- Day Soft Min.
- By Weight

3.5.1 BY DAY AND BY SOFT DAYS CURVE

MIN/MAX LEVEL		
Day	Min	Max
1	1	16
3	2	16
6	3	16
10	4	16
14	5	21
21	6	21
35	7	21
0	0	0
0	0	0
0	0	0

- **Day:** Set growth day
- **Min:** Set minimum ventilation level for controller
- **Max:** Set maximum ventilation level for controller

NOTE: BY DAYS CURVE generates an incremental increase/decrease between the defined days. BY DAYS operates according to the min/max values of the day's min/max values until the following day defined is reached.

3.5.2 BY TIME

MIN/MAX LEVEL		
From	Min	Max
06:00	1	6
10:00	4	8
13:00	6	12
18:00	8	15
21:00	1	3
00:00	0	0
00:00	0	0
00:00	0	0
00:00	0	0
00:00	0	0

- **From:** Set time of day (hh:mm) in 24 hour format
- **Min:** Set minimum ventilation level for controller
- **Max:** Set maximum ventilation level for controller

3.5.3 DAY SOFT MIN.

SOFT MIN/MAX LEVEL			
Day	Min Soft	Min	Max
1	1	11	16
3	2	11	16
6	3	11	16
10	4	11	16
14	5	11	21
21	6	11	21
35	7	11	21
0	0	0	0
0	0	0	0
0	0	0	0

- **Day:** Set growth day
- **Min Soft:** Set minimum ventilation level for when temperature drops below heat temperature
- **Min:** Set minimum ventilation level for when temperature is above heat temperature
- **Max:** Set maximum ventilation level for controller

3.5.3.1 Soft Min/Max Level Help | Set Definitions

⑦ While viewing the *Soft Min/Max Level* menu: Press **HELP**, select **SET**, and press **ENTER**.

SYSTEM PARAMETERS	
SOFT MIN/MAX LEVEL	
Diff. Below Heat for Soft Min.	10.0
Temp Choice for Soft Min. ▶	ATTIC

- **Differential Below Heat for Soft Min:** Set the degree of difference from heat temperature (set in [Control | Temperature Curve](#)) to switch minimum level from **Min.** to **Soft Min.**
- **Temp Choice for Soft Min:** Select inside/outside/attic temperature to control Minimum Level changes. The minimum level adjusts towards the Soft Min as this temperature falls. Above the heat temperature, the minimum level is at the Min setting.

As temperature rises, **INSIDE** and **ATTIC** stay at lowest ventilation level reached until average temperature gets to the heat setting, and then changes instantly. With the **OUTSIDE** selection, the minimum ventilation level increases gradually as temperature rises to the heat setting. This means inside and attic soft min vent choices to latch to the lowest level reached as long as the temperature remains below the heat setting.

3.5.4 BY WEIGHT

NOTE: Only Broilers and Layers mode supports Minimum Ventilation By Weight.

The By Weight option enables controlling the minimum air flow depending on the number of birds, their weight and the current outside temperature. When using the Weight option, Farm Premium takes several parameters and calculates the air speed, level of ventilation and cycle time needed to supply the required volume. As opposed to the other ventilation methods, the Weight option is dynamic, with the ventilation changing according to the current parameters (quantity of air required, weight of birds and number of birds, outside air temperature). In addition, Ventilation By Weight sends out an alarm if the current ventilation is below the minimum required level.

To set up the Weight Option:

1. In *Install > Setup* (page 106) enable Minimum Vent (Power).

2. In *Install > Temperature Definition*, define at least one temperature sensor as Outside.
3. In *Install > Fan Air Capacity*, define the air capacity / hour (page 115).
4. In *Scale > General Setting*, select the curve.
5. In *Scale > Bird Curve*, define the growth days and weights as required.
6. In *Control > Control Mode > Min. Max Level Control* menu, select **Weight**.
7. In *Control > Min/Max Level*, set the parameters as required.

SOFT MIN/MAX LEVEL BY WEIGHT (OUT TEMP)				
Day	Min Level	Air Per Kg/Lb		Max Level
		Cold	Warm	
1	1	0.5	1.5	16
3	1	0.5	1.5	16
6	1	0.5	1.5	16
10	4	1.1	1.7	16
12	4	1.1	1.7	21
15	7	1.1	1.7	21
17	7	1.1	1.7	21
19	7	1.1	1.7	21
21	7	1.1	1.7	21
35	7	0	1.7	22

- **Day:** Set growth day
- **Minimum Level:** Set the minimum level of ventilation (refer to Levels of Ventilation, page 38)
- **Air Per Kg/Lb:** Volume of air per kilogram/pound per hour per bird.
 - Cold: Volume of air supplied when the outside temperature goes down to the *Cold Temperature* parameter (see the following section).
 - Warm: Volume of air supplied when the outside temperature reaches *Warm Temp. - Diff Below Heat* (see the following section).

NOTE: As the level rises between days (for example between day 6 and day 10 in the screen above), the air volume rises proportionally each day, once a day. For example, on Day 7, the Cold Air per Kg/Lb rises to 0.65; on Day 8, 0.8 and so on.

- **Maximum Level:** Set the maximum level of ventilation (refer to Levels of Ventilation, page 38).

8. In *Management > Bird Inventory*, type the number of birds.
9. In the Help menu, define the parameters as required.

3.5.4.1 Min/Max Level By Weight Help | Set Definitions

- ② While viewing the *Min/Max Level by Weight* menu: Press **HELP**, select **SET**, and press **ENTER**

SYSTEM PARAMETERS	
SOFT MIN/MAX LEVEL BY WEIGHT	
Warm Temp. - Diff Below Heat	2.0
Cold Temperature	68.0
Air Change	0.24
Fan Cycle Time (sec, 0 - Manual)	600
Minimum ON Time in Vent Cycle	60
Minimum OFF Time Vent Cycle	60
Air Change by Humidity/CO2 %	20
Air Per Weight Curve Mode	2

- **Warm Temperature – Difference Below Heat:** Differential below the heat temperature (refer to Temperature Curve, page 15) that defines outside temperature as Warm in the Soft Min/Max table. For example, if the Heat Temperature is 78° F, Warm Temp. – Diff Below Heat is 2.0, than the outside temperature is defined as warm at 76° F.
- **Cold Temperature:** Outside temperature (or below) at which Air per Kg/Lb. (Cold) capacity is reached.

When the outside temperature is between the Warm and Cold Temperature, the flow rate is calculated at a proportional rate.

- **Air Change:** As the temperature rises from the Cold Temperature parameter to the Heat Temperature (or drops from the Heat Temperature to the Cold Temperature parameter), the minimal air volume rises/falls proportionally. Air Change defines the minimal change in air temperature that must take place to cause a change in the air supply.
- **Fan Cycle Time:** The total amount of time that the fans operate while operating under Minimum Ventilation. During this time, the fans supply the required volume of air at the minimum ventilation level required. Farm Premium adjusts the minimum ON time and OFF time as needed. If the fans cannot supply the required volume at a particular level of ventilation, Farm Premium automatically adjusts the minimum ventilation level.
 - Minimum ON Time in Vent Cycle: The minimum amount of time that the fans operate during a cycle. Farm Premium adjusts the actual fan time as needed.
 - Minimum OFF Time in Vent Cycle: The minimum amount of time that the fans do not operate during a cycle. Farm Premium adjusts the actual fan time as needed.

As the temperature rises, the actual Minimum OFF Time decreases until it reaches the minimum time; only then does the Minimum On Time begin to rise.

NOTE: If the temperature goes above the Band Temperature, Power Ventilation begins and times are adjusted accordingly.

- **Air Change By Humidity/CO2%:** As the humidity/CO2 levels rise above the levels specified in Humidity Treatment and CO2 Treatment, the minimal air volume rises proportionally. Air Change By Humidity/CO2% defines the minimal change in in these levels that must take place to cause an increase in the air supply.
- **Air Per Weight Curve Mode:** By default, Air per Kilo/Lb. has two data points: cold temperature and warm. If desired, the user can add an additional intermediate data point which is between the two default points. This point determines the quantity of air to be distributed when the temperature reaches the midpoint between the cold and warm temperatures.

SOFT MIN/MAX LEVEL BY WEIGHT (OUT TEMP)					
Day	Min Level	Air Per Kg/Lb			Max Level
		Cold	Warm		
1	1	0.5	0.9	1.5	16
3	1	0.5	0.9	1.5	16
6	1	0.5	0.9	1.5	16
10	4	1.1	1.4	1.7	16
12	4	1.1	1.4	1.7	21
15	7	1.1	1.4	1.7	21
17	7	1.1	1.4	1.7	21
19	7	1.1	1.4	1.7	21
21	7	1.1	1.4	1.7	21
35	7	0	1.4	1.7	22

NOTE: In a three point curve, the intermediate value must be between the cold and warm value in each line.

3.5.4.2 Weight Hot Screen

Selecting the Ventilation by Weight option enables an additional Hot Screen, the Air Status Screen. This screen displays the critical parameters involved in the Ventilation by Weight option.

AIR STATUS				
Inside Temp		24.1		
Outside Temp		21.3		
Humidity		46.7%		
Weight KG		0.468		
		Current	Min	Max
Level		2	1	2
Cycle On		30	30	30
Cycle Off		98	134	66
Total Air M3/h	M3/h	8347	6552	11232
Air/WGT	M3h/kg	0.9	0.7	1.20

- **Inside Temperature:** Current temperature inside the house
- **Outside Temperature:** Current temperature outside the house
- **Humidity:** Current relative humidity inside the house (requires a humidity sensor)
- **Weight KG:** Current average weight of the Bird Curve (page 80)
- **Level:** Displays the current, minimum and maximum level of ventilation.

NOTE: If the current level is below the minimum required level, Farm Premium displays an alarm "Below Min Air".

- **Cycle On/Off:** Displays the current, minimum and maximum fan on and off times.
- **Total Air M3/h:** Displays the current, minimum and maximum quantity of ventilation, per hour.
- **Air/WGT:** Displays the current amount of ventilation, per kilo/pound of bird weight.

3.6 Static Pressure

Set target parameters for Static Pressure at High and Low Outside Temperatures, as well as alarms for high and low static pressure.

- In Installation > Setup, enable a static pressure unit.
- Refer to Static Pressure Calibration, page 96 and Static Pressure, page 92.
 - Disabling the Static Pressure Sensor
 - Static Pressure Help | Set Definitions
 - Multi Stage Tunnel Curtains

STATIC PRESSURE	
Minimum Ventilation	
S.Press. At Low Temperature	0.120
S.Press. At High Temperature	0.080
Low Static Pressure Alarm	0.010
High Static Pressure Alarm	0.150
Static Pressure Band	0.040
Tunnel Ventilation	
Target Static Pressure	0.080
Low Static Pressure Alarm	0.010
High Static Pressure Alarm	0.150
Static Pressure Band	0.040
Attic	
Target Static Pressure	

Minimum Ventilation

- **Static Pressure at Low Temperature:** Set desired static pressure for low outside temperature conditions. Be sure that there is proper airflow at this setting.
- **Static Pressure at High Temperature:** Set desired static pressure for high temperature conditions. Normally this pressure is lower to obtain a larger air inlet opening.

NOTE: Controller interpolates between the LOW and HIGH Temperature. If Static Pressure exists, then it is controlled by the outside temperature sensor, otherwise the average temperature.

- **Low Static Pressure Alarm:** Set alarm for low static pressure. If you disable it by setting zero, the Farm Premium warns you and enters a record in the Table of Events.
- **High Static Pressure Alarm:** Set alarm for high static pressure.
- **Static Pressure Band:** Set desired band for the target pressure.

Tunnel Ventilation

- **Target Static Pressure:** Set required static pressure for Tunnel Ventilation Mode.
- **Low Static Pressure Alarm:** Set alarm for low static pressure.
- **High Static Pressure Alarm:** Set alarm for high static pressure.
- **Static Pressure Band:** Set required band for pressure in tunnel ventilation mode.

Attic

- **Target Static Pressure:** Set required static pressure when in attic mode.
- **Static Pressure Band:** Set required band for attic ventilation mode.

3.6.1 DISABLING THE STATIC PRESSURE SENSOR

To disable the static pressure sensor:

1. Go to *Installation > Setup*.
2. Set the Static Pressure Unit to **None**.

The main screen stops:

- displaying the pressure
- displaying High Pressure and Pressure Sensor Failure alarms

NOTE: If either of these alarms were active before disabling the sensor, the main screen continues to display the alarms. Reset the alarms one time to cease the display.

3.6.2 STATIC PRESSURE HELP | SET DEFINITIONS

- ② While viewing the Static Pressure menu: Press **HELP**, select **SET**, and press **ENTER**.

SYSTEM PARAMETERS	
STATIC PRESSURE	
Wind Gust Delay Time (sec)	10
S. Pressure During Tunnel	▶ YES
Transitional Tunnel	▶▶ NO
Minimum Ventilation Using	▶▶ VENT
Low Incoming Air (diff to Trg)	-25.0
High Incoming Air (diff to Trg)	-10.0
Emergency S. Press. Delay (sec)	60
Curt. Pos. In Emerg. S. Press.%	100
Low S.P. Alarm Min. Level (MinV)	0
Low S.P. Alarm Min. Level (Tun.)	0
Time To Produce S. Pressure (sec)	10
Attic Advance Opening Time (sec)	0

- **Wind Gust Delay Time (seconds):** Set length of time in seconds before starting Static Pressure control after an unexpected change in air pressure.
- **Static Pressure During Tunnel:** Select **YES** or **NO** for using Static Pressure control when in Tunnel mode.
- **Transitional Tunnel:** Select **YES** or **NO** for using tunnel curtains when static pressure is high and vents are already at 100%.
- **Minimum Ventilation Using (vent/curtain):** Select **VENT** or **CURTAIN** for controlling static pressure when in minimum ventilation.
- **Low Incoming Air (Difference to Target):** Define low temperature for static pressure control.
- **High Incoming Air (Difference to Target):** Define high temperature for static pressure control.
- **Emergency Static Pressure Delay (seconds):** Set length of time in seconds before initiating an emergency opening when pressure exceeds high alarm setting.
- **Curtain Position in Emergency Static Pressure (%):** Set the desired curtain position (in percentage) when an emergency pressure event occurs.
- **Low Static Pressure Alarm Minimum Level (MinV):** Below this level, the controller ignores low static pressure alarms.
- **Low Static Pressure Alarm Min. Level (Tunnel):** Below this level, the controller ignores low static pressure alarms while in tunnel mode.
- **Time to Produce Static Pressure (seconds):** Enter the length of time to reach target pressure when minimum ventilation fan cycle is on.
- **Attic Advance Opening Time (seconds):** Define the amount of time for the attic inlets to open before minimum vent cycling fans turn on.

3.6.3 MULTI STAGE TUNNEL CURTAINS

When in static pressure mode and employing multiple tunnel curtains, Farm Premium can open the curtains in sequence. Opening the tunnel curtains commences when the target static pressure is reached and the controller signals to the tunnel machine to operate the curtains. Farm Premium opens the first tunnel curtain (as defined in the relays) to the user defined level. If additional ventilation is required, the second tunnel curtain opens. This process continues for each defined curtain.

As pressure falls, the process is reversed; curtains close in progression starting with the last curtain.

To set up Multi Stage Tunnel Curtains:

1. In *Installation > Relays* define more than one relay as tunnel curtain (open and close).

2. In *Device > Vent & Curtain Levels*, define the opening levels for each curtain.
3. In *Static Pressure > Tunnel Ventilation*, define the target pressure.

3.7 Control Mode

Select house-operating modes, turn temperature curves on or off and select which type of min/max level method to use.

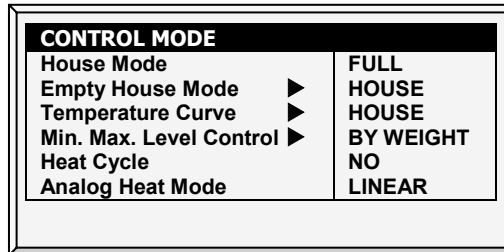

- **House Mode:** Select whether the house is in one of the brood set ups, or in full house.
- **Empty House Mode:** Select YES to disable alarms.
- **Temperature Curve:** If you select OFF, temperature settings become fixed values until midnight on the next setting in [Control | Temperature Curve](#) (page 15).
- **Min. Max. Level Control:** Set ventilation control method (By Days, By Days Curve, By Time, By Soft Min, and Weight). Refer to Min/Max Level, page 26 for more details)
- **Heat Cycle:** Enable cycle heaters. Refer to Cycle Heaters | Set Definitions, page 18.
- **Analog Heat Mode:** Define the variable heating mode (Linear, Proportional, Linear Valve). Refer to Variable Heater Help | Set Definitions, page **Error! Bookmark not defined.**

3.8 System Parameters

System Parameters consolidates all of the **HELP | SET** menus into one scroll screen.

Page	System Parameter
16	Temperature Curve
Error! Book mark not defined.	Cycle Heater
17	Radiant Heater
19	Variable Heater
24	Humidity Treatment
26	CO2 Treatment
33	Static Pressure
39	Ventilation Levels
42	Curtains

Page	System Parameter
113	Curtain Calibration
42	Attic
46	Cooling Pad
47	Cool Pad Flush
48	Foggers
50	Light
53	Water and Feed
68	Feed Inventory
55	Emergency Setting
60	Natural Entrance Conditions
61	Wind and Rain Effect
70	Alarm Setting
57	Water on Demand - Nipple Flush

3.9 Ammonia Treatment

Ammonia treatment forces an increase in ventilation level when the ammonia level is too high. To prevent fans changing their ventilation too often, treatment begins after a user-defined delay. The user also defines the treatment duration.

After the duration, the ventilation level may come back down automatically. If during treatment, the ammonia level drops below the **Stop Value** parameter, the ventilation level automatically returns to that level used before ammonia treatment began.

AMMONIA TREATMENT				
Day	Start Value	Stop Value	Delay (Sec)	Duration Sec.
1	2	30	120	130
7	2	30	120	150
14	2	30	90	180
0	2	0	0	0
0	2	0	0	0
0	2	0	0	0
0	2	0	0	0
0	2	0	0	0
0	2	0	0	0
0	2	0	0	0

➔ This function requires an ammonia sensor.

1. In *Install* > *Analog Sensors* (refer to *Analog Sensors*), designate one sensor as an ammonia sensor.
2. If required, go to *Service* > *Ammonia* and calibrate the sensors (refer to *Ammonia Calibration*).
3. In *Control* > *Ammonia Treatment* set the parameters.

- **Day:** Growth day. You can set multiple programs for same day (maximum number of programs: 20)
- **Start Value:** Ammonia value at which to begin treatment. Range: 0 to 100. Default: 2

NOTE: Ammonia levels should not be higher than 30 ppm.

- **Stop Value:** Ammonia value at which to end treatment. Range: 0 to 100. Default: 2
- **Delay (Sec):** When the ammonia level reaches the start value, the controller delays treatment for this amount of time. Default: 0
- **Duration (Sec):** Number of seconds the controller maintains the increased level of ventilation. Default: 0

4. Set the Ammonia Alarm (page 72).

3.9.1 AMMONIA TREATMENT HELP | SET DEFINITIONS

- ⑦ While viewing the Ammonia Treatment menu: Press *HELP*, select *SET*, and press *ENTER*.

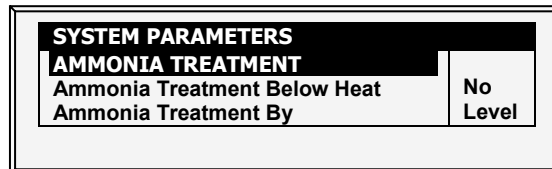

- **Ammonia Treatment below Heat:** Select: Select YES or NO to enable Ammonia Treatment when heaters are operating (set in Temperature Curve).
- **Ammonia Treatment By:** This parameter designates the method used when ammonia treatment begins. Normally, this parameter is relevant only when minimum ventilation is running. When a treatment is required, select the method to be employed:
 - **Level:** Increases the ventilation level when a treatment is required.

NOTE: When employing Ventilation by Weight, the controller increases the cycle time or the level, depending on the particular settings.

- **Exhaust:** Designate a specific exhaust fan (press a number key to select the fan).
- **Tunnel:** Designate a specific tunnel fan (press a number key to select the fan).
- **None:** Disables the treatment.

4 Device Menu

The Farm Premium can have many closely spaced levels of ventilation enabling it to find the optimum average airflow for the poultry facility. Many of the levels are at exactly the same temperature setting, so there may be a question as to how the Farm Premium chooses the correct level.

The menus in this section apply levels to ventilation, variable speed fans, curtains, and other related matters. The levels in the various menus are consistent with each other so that a level in one menu corresponds with that level in any other menu.

The rules that apply here are:

- **Rule 1:** If the temperature is at target (in the Happy Zone) stay at the current level.
- **Rule 2:** If the temperature moves outside the Happy Zone; have some patience.
- **Rule 3:** After the designated delay, increase or decrease levels appropriately.

You can find the 'patience' factors under [HELP | SET](#) in this menu. They are the *increase level delay* and *decrease level delay* parameters. The factory default values are 180 seconds for an increase and 60 seconds for a decrease.

The factory default values bias the Farm Premium slightly toward warmer temperatures, as would be appropriate for young birds. The level increase delay is longer than the level decrease delay. You may wish to reverse these values by the time you have market age broilers, since they are more sensitive to heat stress than to cold.

Although many of the levels have 0.0 differential temperatures, certain levels should have differentials to account for wind chill on the birds. The first tunnel level accounts for wind chill by switching to the tunnel temperature instead of target temperature. Higher tunnel levels require an additional wind chill because of the increased airflow.

In addition, the last few levels before entering tunnel can form a transitional region. You may want to build differentials from target temperature just before the first tunnel level.

The controller obeys both the time delay rules and the differential temperature rules when changing levels. Tunnel exit has several additional rules, such as outside temperature restriction and the tunnel exit delay described under [HELP | SET](#). In addition, there are Cool Down and change to Min Vent on reaching the Heat temperature features described in [Control | Temperature Curve | HELP | Set](#) parameters.

The following sections detail the menu functions.

- Levels of Ventilation, page 38
- Variable Speed Fan Levels, page 41
- Vent & Curtain Levels, page 41
- Stir Fan Levels, page 43
- Stir Fan Program, page 44
- Cool Pad, page 46
- Foggers, page 47
- Light, page 49
- Water & Feed, page 51
- Extra Systems, page 54
- Emergency Setting, page 54
- Water on Demand, page 56
- Natural Program, page 58

DEVICE SETTING	
1.	LEVELS OF VENTILATION
2.	SPEED FAN LEVELS
3.	VENT & CURTAIN LEVELS
4.	STIR FAN LEVELS
5.	STIR FAN PROGRAM
6.	COOL PAD
7.	FOGGERS
8.	LIGHT
9.	WATER & FEED
10.	EXTRA SYSTEMS
11.	EMERGENCY SETTING
12.	WATER ON DEMAND
13.	NATURAL PROGRAM

4.1 Levels of Ventilation

The Precision Ventilation table provides up to 30 ventilation levels controlling both variable fans and relay-controlled fans. To program this table, start with the minimum ventilation used in the first level and increase ventilation gradually. A reasonable rule of thumb is to increase the airflow about 25% at each level. Increases in airflow up to 50% work satisfactorily with factory default settings.

1. Do one or both:
 - In *Install > Relay Outlet* (refer to page 107) define at least one relay as a Tunnel Fan or Exhaust Fan.
 - In *Install > Analog Output* (refer to page 110) define one function as Tunnel Fan or Exhaust Fan.
2. In *Device Setting > Levels of Ventilation* configure the parameters as required.
3. Configure the Help Set parameters as required.

LEVELS OF VENTILATION									
No	Diff Deg.	On Sec	Exhaust			Tunnel			
			1	2	3	1	2	3	
1	0.0	30	◇	◇	◇	▪	▪	▪	
2	0.0	45	◇	◇	◇	▪	▪	▪	
3	0.0	60	◇	◇	◇	▪	▪	▪	
4	0.0	80	◇	◇	◇	▪	▪	▪	
5	0.0	120	◇	◇	◇	▪	▪	▪	
6	0.0	160	◇	◇	◇	▪	▪	▪	
7	0.0	200	◇	◇	◇	▪	▪	▪	
8	0.0	250	◇	◇	◇	▪	▪	▪	
9	0.0	100	◇	◇	◇	▪	▪	▪	
10	0.0	120	◇	◇	◇	▪	▪	▪	
11	0.0	150	◇	◇	◇	▪	▪	▪	
12	0.0	180	◼	◼	◼	▪	▪	▪	
13	0.0	0	◼	◼	◼	▪	▪	▪	
14	0.0	150	◼	◼	◼	▪	▪	▪	
15	0.0	0	◼	◼	◼	▪	▪	▪	
16	0.0	0	◼	◼	◼	▪	▪	▪	

0.0.
Air Capacity: 300
Chill Range:

-Continuous
--- -Cycle
-Rotate
Tunnel Level: T

NOTE: The number appearing under Exhaust and Tunnel refers to the numbers defined in Installation.

- **Number:** Read-only showing the ventilation level.

NOTE: At the First Tunnel Level (defined in the Help | Set Definitions) the screen displays the tunnel temperature (defined in Temperature Curve). ■ means the level is in tunnel mode.

- **Differential Temperature:** Triggers next level according to difference from target temperature (time delays remain in effect).
 - The first several levels normally have differential temperatures set to 0.
 - If the ventilation level is below tunnel, the differential temperature is relative to the Target temperature given in [Control | Temperature Curve](#).
 - If the ventilation level is a tunnel level, the differential temperature is relative to the Tunnel temperature given in [Control | Temperature Curve](#).
- **Cycle timer ON:** Set ON time for fans for that ventilation level.
- **Cycle timer OFF:** Set OFF time for fans of that ventilation level. This parameter disappears if cycle time is set in the [HELP | SET](#) Parameters to something other than 0 and the controller calculates the "Cycle timer OFF" automatically.
- **Exhaust:** Control exhaust fans according to **Continuous, Cycle, and Rotate**.
- **Tunnel:** Control tunnel fans according to **Continuous, Cycle, and Rotate**.
- **Air Capacity:** Displays the current exhaust fan or tunnel air flow for each ventilation level. If Variable Speed Fan Levels have been set (refer to page 41), the speed percentage is taken into account.



Continuous: Works constantly without a break



Cycle: Operates according to ON/OFF timer



Rotate: Operates according to ON/OFF timer; in each cycle a different fan operates

4.1.1 LEVELS OF VENTILATION HELP | SET DEFINITIONS

② When viewing the Levels of Ventilation menu: Press *Help*, select *Set*, and press *Enter*.

SYSTEM PARAMETERS	
LEVELS OF VENTILATION	
Maximum Levels of Ventilation	22
First Tunnel Level	5
Max Fans, Switch to Tunnel	20
Tunnel Exit – Diff Below Tunnel	2.0
Tun Exit-Out T. Diff from Tun.	9.0
Increase Level Delay Time (sec)	120
Decrease Level Delay Time (sec)	90
Fan Cycle Time (sec, 0-Manual)	0
Tunnel Exit Delay (minutes)	2
Wind Chill Enable	NO
Wind Chill Limit	14.4
RH Effect	0.5

- Define
 - **Maximum Levels of Ventilation:** Set the maximum number of levels.
 - **First Tunnel Level:** Set the entry point to tunnel mode. Zero disables this parameter.

- **Max Fans, Switch to Tunnel:** Set the maximum number of fans allowed to operate when entering tunnel mode.
- **Tunnel Exit – Differential Below Tunnel:** Set degree of difference below Tunnel temperature (set in [Control | Temperature Curve](#)) to Exit Tunnel mode.
- **Tunnel Exit – Outside Differential from Tunnel:** The outside temperature must read below this (Tunnel + Differential) to allow exiting from tunnel mode.
- **Increase Level Delay Time (sec):** Set length of time in seconds before transitioning to next level.
- **Decrease Level Delay Time (sec):** Set length of time in seconds before transitioning to lower level.
- **Fan Cycle Time (sec):** If set to 0, set on and off times for each level manually. If you are using a fixed cycle time, such as 300 seconds, enter it here and enter only the **On** time at each level. Default: 0
- **Tunnel Exit Delay (minutes):** Set length of time in minutes before exiting Tunnel mode. This time begins once all other parameters are satisfied.
- **Wind Chill:** Refer to the following section.

4.1.2 WIND CHILL

Farm Premium can take into consideration the wind chill factor when making certain calculations related to the temperature. In effect, the wind chill factor acts as the temperature differential. When enabled, Farm Premium determines the “calculated temperature (actual temperature – wind chill temperature) and uses this temperature:

- When calculating the Tunnel Mode level up/down algorithms
- When operating the Cool Pad (if enabled in System Variables; refer to Operate Cool Pad, page 40).

NOTE: The Wind Chill factor influences controller operation from the 1st tunnel level.

The actual temperature: 1) determines the entry and exit into Tunnel Mode 2) controls the fogger.

Parameters:

- **Wind Chill:** Enable this parameter to include the wind chill factor in ventilation calculations. Default = No.
- **Wind Chill Limit:** Maximum wind chill factor value. Default = 8° C.
- **RH Effect:** The decrease in temperature caused by an increase in relative humidity. Default is 0.26° C.

The Relative Humidity Effect parameter enables including the relative humidity (RH) in the wind chill factor calculations. A rise in relative humidity reduces the wind chill factor. How does it work?

- There is no effect below 40% relative humidity.
- The user determines the increase in temperature for every 5% increase in relative humidity.
 - The default increase is 0.26° C; meaning that between 40.1% - 45% relative humidity, the wind chill factor decreases by 0.26° C. Between 45.1% - 50%, the wind chill factor decreases by 0.52° C, twice the default level. Between 50.1% - 55%, the decrease is 0.78° C, three times the default level, and so on.
 - The user can set the temperature increase as required.
 - To disable this feature, enter '0'

4.2 Variable Speed Fan Levels

In the Variable Speed Fan Level table set the speed in percentages by level.

➤ This function requires an Analog Output card.

This card sends a low voltage control signal to a variable speed controller to run the variable speed fan. Several kinds of speed controllers are available, such as TRIAC Control, and Variable Frequency Three Phase drives.

VARIABLE SPEED FAN LEVEL			
Level	Tun 2	Exh 2	Exh 3
1	----	30	30
2	----	30	30
3	----	30	45
4	45	45	45
5	45	60	45
6	60	60	60
7	60	75	60
8	75	75	75
9	90	90	90
10	100	90	100

1. In *Install > Analog Output* (refer to Analog Output, page 110), define at least one output as a variable speed fan.

2. In *Device Setting > Levels of Ventilation*, define the mode (required!).

NOTE: "—" appears when this variable fan is not defined as operating at this ventilation level.

3. In *Device Setting > V. Speed Fan Levels*, define the fans' working percentages.

4.3 Vent & Curtain Levels

Set the curtain levels to correspond with the ventilation levels. The operating mode determines the curtain control procedure.

NOTE: Users employing Layers Mode, refer to *Layers Vent and Curtain Levels*, page 121.

NOTE: Before setting the levels, define the opening mechanism (refer to *Vent / Curtain Setup*, page 111).

1. In *Install > Relay Outlet* (refer to page 107), define at least one relay as Curtain Open, Tunnel Open, Vent Open, or Attic Open.

2. If your installation includes curtains, in *Install > Setup*, define Natural Ventilation as Level or Power.

NOTE: When Natural Ventilation is Off, the Curtains don't appear in the screen.

3. In *Control > Temperature curve*, define the Target Temperature.

4. In *Device Setting > Vent & Curtain Levels*, define the minimum opening percentages.

5. Press **Enter**.

6. If required, configure each opening to work with a particular temperature sensor. Refer to *Temperature Definition*, page 114.

7. Set the Help Set parameters as required.

VENT & CURTAIN LEVELS		
Level	Tunnel	Vent
1	0	15
2	0	15
3	0	15
4	0	15
5	0	15
6	0	15
7	0	15
8	0	15
9	0	15
10	0	15

- **Ventilation Level:** Read-only.
- **Tunnel/Curtain/Vent/Attic:** Set position for the tunnel curtain by level. If you have Static Pressure in Tunnel turned on ([Control | Static Pressure | Help | Set](#)), this becomes the minimum position for the tunnel inlet.

4.3.1 VENT & CURTAIN LEVELS HELP | SET DEFINITIONS

- ② While viewing the Vent & Curtain Levels menu: Press **HELP**, select **SET**, and press **ENTER**.

SYSTEM PARAMETERS	
CURTAINS	
Stop Fans, Curt. Move (total %)	30
1st Day for 2nd Vent to Oper.	-2
1st Level for 2nd Vent to Oper	1
ATTIC	
Minimum Attic Temp. To Operate	75
Operate Until Day	10
Operate Until Level	10
Operate From Time	0:00
Operate To Time	0:00
Max Temperatur to Disable Attic	100.0

Curtains

- **Stop Fans, Curtain Move (total %):** Commands controller to stop fans during curtain movements when total of all curtains is less than the total percent set in this parameter. For example, 3 curtains at 40% each total 120% for this parameter. Default: 30%
- **1st Day for 2nd Vent to Operate:** Set the day the second vent begins operating. Default: 1.

NOTE: You can set negative days.

- **1st Level for 2nd Vent to Operate:** Set the level the second vent begins operating. Default: 1

Attic

- **Minimum Attic Temperature To Operate:** Set the minimum temperature to activate the Attic operation.
- **Operate Until Day:** Set the last day for attic operation (**broilers only**).
- **Operate From/To Time:** Set the time frame for attic operation.

NOTE: If one of the above options is relevant, the Attic is enabled.

- **Maximum Temperature to Disable Attic:** Set the maximum attic temperature to stop using attic ventilation. This setting can prevent the heating effect in the growing space being too high resulting in overheating.

4.4 Stir Fan Levels

1. Do one or both:
 - In *Install > Relay Outlet* (refer to page 107), define at least one relay as a Stir Fan or
 - In *Install > Analog Output* (refer to page 110) define one function as Variable Stir Fan.
2. In *Device > Stir Fan Levels*, define the parameters as required.
3. Map each stir fan to a temperature sensor (refer to Temperature Definition, page 114) (option).

STIR FAN LEVELS		
Level	Stir Fan No	Variable Fan
	123456789012345	3 4
1	● ...	◀▶ ◊
2	● ...	◀▶ ◊
3	● ...	◀▶ ◊
4	...	◀▶ ◊
5	...	◀▶ ◊
6	...	◆ ◆
7	...	

●-Continuous ◀-Cycle On ○-Cycle Off

In the Stir Fan Level table set the speed in percentage that you want the variable speed fan to work at (by levels). For each level, program the stir fans' cycle. Configure the actual speed in Analog Output, page 110.

NOTE: The numbers shown in the screen under Variable Fan depend on how you defined the fans in Installation > Relay Layout and Analog Output.

NOTE: **T** means the level is in tunnel mode.

- **Ventilation Level:** Read only.
- **Variable Fan:** Set variable speed fan operation in percentages.
- **Stir Fan Number:** Control stir fans according to Continuous, Cycle On, Cycle Off (ventilation cycles are the same as previously set in [Levels of Ventilation](#). Press +/- to set the operation cycle.



Continuous: Constantly works without a break.



Cycle: Operates according to ON/OFF timer.



Rotate: Operates according to ON/OFF timer; in each cycle a different fan operates

NOTE: The Stir Fans operate according to the levels you program in this menu, and according to the programs you select in the Stir Fan Program. The fan turns on if any program or level requests ON; all programs and levels must be OFF for the Stir Fan to be off.

4.5 Stir Fan Program

This section contains five different programs that you can assign to each stir fan. Check the programs applying to each fan by using the '+/-' key (further explained in [STIR FAN PROGRAM HELP | SET](#)).

NOTE: If the same variable stir fan is selected for different programs, the program having the highest fan speed operates.

NOTE: The ~ symbol designates an analog output device.

STIR FAN PROGRAM					
Fan	P R O G R A M				
No.	-A-	-B-	-C-	-D-	-E-
1	✓	✓	▪	▪	▪
2 ~	✓	▪	✓	▪	✓
3 ~	▪	✓	✓	✓	▪
4 ~	▪	▪	✓	✓	✓
5	▪	▪	▪	▪	▪
6	▪	▪	▪	▪	▪
7	▪	▪	▪	▪	▪
8	▪	▪	▪	▪	▪

- **A (heaters):** This program corrects temperature variations lengthwise in the building. Insert diff and sensor numbers.
- **B (for min vent):** This program helps mixing minimum ventilation air for buildings having stir fans to mix the air coming in with warm inside air.
- **C, D & E (sensors diff temperature):** These options create three stir fan groups which operate according to sensor differentials.

4.5.1 STIR FAN PROGRAM HELP | SET DEFINITIONS

- ① While viewing the *Stir Fan Program* menu: Press **HELP**, select **SET**, and press **ENTER**.

SYSTEM PARAMETERS	
PROGRAM A (for min vent)	
Diff below Target to Operate:	0.6
Cycle On time (sec):	0
Cycle Off time (sec):	0
From Level	0
To Level	0
From Time (hh:mm)	00:00
To Time (hh:mm)	00:00
Stop During Fan Operation	YES
PROGRAM B (sensors diff temp)	
Operate after End of Cycle	YES
Delay for Operation	2.0
Time for Operation	5.0
From Level	0
To Level	0
From Time	00:00
To Time	00:00

Program A (for Heaters)

- **Diff below Target to Operate:** Set the degree of difference below the target temperature for stir fans to operate.
- **Cycle On time (sec):** Define the length of time in seconds you would like the stir fan to operate during the cycle.
- **Cycle Off time (sec):** Define the length of time in seconds you would like the stir fan to be off during the cycle.
- **From/To Level:** Limit the program to operate between the levels defined.
- **From/To Time:** Define the time frame for the program to operate (24-hour format).
- **Stop During Fan Operation:** Select **YES** run the heaters when the fans are operating.

Program B (for Min Vent)

- **Operate after End of Cycle:** Set when stir fan begins operating. It can be at the end of the ON cycle or the OFF cycle set in the [DEVICE | Levels of Ventilation](#).
- **Delay for Operation (sec) (+/-):** Define length of time in seconds from the end or start of cycle you chose in **Operate after end of cycle** above, for the stir fans to operate.
- **Time for Operation (sec):** Define length of time in seconds for the stir fans to operate.
- **From/To Level:** Limit the program to operate between the levels defined.
- **From/To Time:** Define the time frame for the program to operate (24-hour format).

Program C, D, E (Sensors Diff Temp or Independent)

- **Temp Diff to Operate:** Set the degree of difference between sensors for stir fans to begin operating.

NOTE: If this parameter is set to 0 (zero), the variable stir fan runs independently of the sensors.

- **Diff between Sensor Number:** Select a sensor to define one temperature reading.
- **Diff between Sensor Number:** Select a second sensor to define a temperature reading from a different area.
- **Cycle On time (sec):** Define the length of time in seconds you would like the stir fan to operate during the cycle.
- **Cycle Off time (sec):** Define the length of time in seconds you would like the stir fan to be off during the cycle.
- **From/To Level:** Limit the program to operate between the levels defined.
- **From/To Time:** Define the time frame for the program to operate (24-hour format).
- **Stop During Fan Operation:** Select **YES** run the heaters when the fans are operating.
- **Variable Stir Fan:** Select the stir fan to be used
- **Min/Max Variable Stir Fan Speed:** Enter the minimum and maximum speed (in percentage).

4.6 Cool Pad

This menu sets the cool pad operating conditions.

NOTE: Cool Pads only operate when the controller is in tunnel mode. For example, if the cool pad is set to run at Level 8 and the tunnel mode begins at level 10, the cool pad remains inoperative.

COOL PAD						
Day	Start Time	End Time	Tunnel Diff	To Hum	On sec	Off sec
1	10:00	21:00	3.0	99	15	285
7	10:00	21:00	3.0	99	15	285
7	10:00	21:00	5.0	99	45	255
14	10:00	21:00	2.0	99	15	285
14	10:00	21:00	3.0	99	30	270
14	10:00	21:00	4.0	99	45	255
14	10:00	21:00	5.0	99	60	240
14	10:00	21:00	6.0	99	75	225
14	10:00	21:00	7.0	99	100	200
14	10:00	21:00	8.0	99	200	100

- **Day:** Set growth day.
- **Start Time:** The cool pad begins operating at this time.
- **End Time:** The cool pad ceases to operate at this time.
 - It is possible to set multiple start and stop times for a single day.
 - In the screen above, growth day jumps from day 7 to day 14, the cool pad continues to work according to day 7 settings from growth day 7 through growth day 14.
- **Tunnel Differential:** Set difference from tunnel temperature to use this setting. You can use negative differential temperatures.
 - Note the settings for Day 14. The Farm Premium uses the maximum temperature differential that applies to choose the correct settings.
- **To Humidity:** Set maximum humidity allowed before stopping cool pad. You can enter 100%.
- **On Sec:** Set the maximum on time for each cycle of cool pad operation.
- **Off Sec:** Set the minimum off time for each cycle of cool pad operation.

4.6.1 COOL PAD HELP | SET DEFINITIONS

② While viewing the *Cool Pad* menu: Press **HELP**, select **SET**, and press **ENTER**.

SYSTEM PARAMETERS	
COOL PAD	
Temperature Band	2.0
Humidity Band (%)	2
Diff Between Cool Pads Stage	0.0
Cool Pad-1 Min Level	1
Cool Pad-2 Min Level	1
Cool Pad-3 Min Level	1
Cool Pad-4 Min Level	1
COOL PAD FLUSH	
Flush Cool Pad At:	00:00
Cool Pad Flush Duration (minute)	0

- **Temperature Band:** Define the on/off hysteresis relative to temperature.
- **Humidity Band (%):** Define the on/off hysteresis relative to humidity.

- **Difference Between Cool Pads Stage:** Farm Premium supports four cooling pad stages. The controller activates the first stage when the temperature reaches the Tunnel Temperature (*Control > Temperature Curve*) plus the Tunnel Differentiation (set in the Cool Pad screen). Each additional stage begins when the temperature reaches the Tunnel Temperature plus the Tunnel Differentiation plus this differentiation.

For example, if:

- Tunnel Temperature = 80°
- Tunnel Diff = 2
- Diff between Cool Pads Stage = 3

Stage 1 starts at 82°, Stage 2 at 85°, Stage 3 at 88°, and Stage 4 at 91°.

Example: Cool Pad ON temperature = 80°, Diff set to 2° F:

Cool Pad #	Assigned Sensor	Diff Between Cool Pads Stage	Actual ON temperature
1	Average	0.0	80°
2	Average	2.0	82°
3	Temp Sensor 2	0.0	80°
4	Temp Sensor 2	2.0	82°

- **Cool Pad Minimum Level:** In systems having more than one pump, this parameter enables keeping a cool pad inoperative until the associated tunnel curtain turns on. Define the minimum level for each cool pad.

NOTE: When the Difference Between Cool Pads Stage is enabled, the cool pads operate according to both conditions.

Cool Pad Flush

- **Flush Cool Pad At:** Set time of day (hh:mm) to start continuous water application to remove deposits from the cool cells.
- **Cool Pad Flush Duration (minutes):** Set the length of time in minutes for flushing. If this parameter is set, flush is applied without regard to ventilation level or operating mode.

4.7 Foggers

This menu sets the operating conditions for the Foggers.

- Foggers and Cool Pad have a different temperature reference point. The Fogger Temperature Differentials are relative to the target temperature; the Cool Pad is relative to the tunnel entry temperature.
- Foggers operate even when the controller is not in tunnel mode.

FOGGERS						
Day	Start Time	End Time	Target Diff	To Hum	On sec	Off sec
47	12:00	21:00	18.0	99	300	600
47	12:00	21:00	20.0	99	300	300
0	00:00	00:00	0.0	0	0	0
0	00:00	00:00	0.0	0	0	0
0	00:00	00:00	0.0	0	0	0
0	00:00	00:00	0.0	0	0	0
0	00:00	00:00	0.0	0	0	0
0	00:00	00:00	0.0	0	0	0
0	00:00	00:00	0.0	0	0	0
0	00:00	00:00	0.0	0	0	0
0	00:00	00:00	0.0	0	0	0

- **Day:** Set growth day
- **Start Time & End Time:** Time of day you want foggers to start and stop.
 - It is possible to set multiple start and stop times for single day.
 - In the screen above, the first programmed line is at day 47. The foggers do not operate before growth day 47 in this case. Since there are no entries other than day 47, the day 47 program lines apply from then on.
- **Target Differential:** Set difference from target temperature to trigger foggers.
- **To Humidity:** Set maximum humidity allowed before stopping foggers.
- **On Sec:** Set the maximum on time for each cycle of fogger operation.
- **Off Sec:** Set the minimum off time for each cycle of fogger operation.

4.7.1 FOGGERS HELP | SET DEFINITIONS

② While viewing the Foggers menu: Press **HELP**, select **SET**, and press **ENTER**.

SYSTEM PARAMETERS	
FOGGERS	
Temperature Band	2.0
Humidity Band (%)	2.0
Min Level to Enable Operation	1
Max Level to Enable Operation	30
Enable Rotation	NO
Difference between Foggers Stage	0.0

- **Temperature Band:** Define the on/off hysteresis relative to temperature.
- **Humidity Band (%):** Define the on/off hysteresis relative to humidity.
- **Min Level to Enable Operation:** Select the minimum ventilation level to operate the foggers.
- **Max Level to Enable Operation:** Set the maximum ventilation level for fogger operation.
- **Enable Rotation:** Enable this function to use a different fogger relay each cycle. This function enables dispersing the droplets at a higher pressure, to wet the animal.

NOTE: Munters recommends keeping this function set at the default setting (No).

- **Difference between Foggers Stage:** Farm Premium supports four fogging stages. The controller activates the first stage when the temperature reaches the Target Temperature (*Control > Temperature Curve*) plus the foggers differential. Each additional stage begins when the temperature reaches the Target Temperature plus the fogger differentiation.

For example, if:

- Foggers Target Temperature = 80°

- Diff between Foggers Stage = 3
Stage 1 starts at 83°, Stage 2 at 86°, Stage 3 at 89°, and Stage 4 at 92°.

4.8 Light

This menu sets the lights operating conditions. The controller has a capacity for up to four channels of *On/Off Lights* and up to 10 channels of *Dimmer Lights*. In addition, this menu enables using a light sensor.

1. In *Install > Analog Output* (refer to *Analog Output*, page 110) define up to four outputs as light dimmers.
2. In *Device Setting > Light*, define the parameters as required.

LIGHT						
Day	Time	Light			Intensity (%)	
		1	2	3	1	2
1	00:00	✓	✓	■	100	0
12	00:00	✓	■	✓	45	45
12	01:00	■	■	■	0	0
12	03:00	✓	■	✓	45	45
12	21:00	■	■	■	0	0
25	00:00	■	■	■	0	0
25	03:00	■	■	■	35	35
25	20:00	■	■	■	0	0
25	23:00	■	■	■	35	35
0	00:00	■	■	■	0	0

Water & Feed (page 51) configuration defines the Light Menu configuration:

- If you select Daily, the above screen appears when you select Light; configure the Light menu once.
- If you select 2 – 6 Days or Week, the screen below appears.

**Please Select
Light Table for Feed/No Feed
Days.
Select Table**

FEED
NO FEED

1. Select Feed and press **Enter**. The Light parameters screen appears. These parameters configure the Light functions on feed days.
2. Configure the parameters.
3. Select No Feed and press **Enter**. The Light parameters screen appears. These parameters configure the Light functions on non-feed days.
4. Configure the parameters.
 - **Day:** Set Growth Day

In the example, the brood lights (channel 1) and bright center lights (channel 2) turn on from day 1, while the grow end lights (channel 3) are off. The example shows two channels of light dimmer, Channel 1 at 100% and Channel 2 at 0% (for baby chicks in the brood zone).

- **Time:** Set event times for the lights.
 - On day 12, the center lights turn off, and the dimmer lights go to 45%. There are two periods of darkness: from 01:00 to 03:00 in the morning, and 09:00 PM to midnight. This program repeats until day 25.
 - From day 25 the on/off lights stay off, and the dimmer lights provide dim light during the on periods, and go out fully for two periods of darkness. The dark periods total 6 hours, being from midnight to 03:00 AM and from 08:00 PM (20:00) to 11:00 PM (23:00).
- **Light:** Check mark the desired light(s) to turn on. Apply dots for lights you would like to turn off. Switch between check marks and dots by pressing the +/- key.
- **Intensity (%):** Set intensity in percentage for light dimmer(s). Dimmer lights start to brighten if the intensity increases, and complete dimming if the intensity decreases at the set time. That is, they start dimming the 'sunset time' in advance of the set time (see **Help | Set** below).

4.8.1 LIGHT HELP | SET DEFINITIONS

NOTE: *Pig Mode does not support Light Help parameters.*

② While viewing the Light menu: Press **HELP**, select **SET**, and press **ENTER**.

DEVICE SETTING	
LIGHT	
Sunrise Time (minutes)	10
Sunset Time (minutes)	10
Allow Spiking from Day	1
Spike Cycle (minutes)	0
Spike Duration (minutes)	0
Spike Increase Amount (%)	0
Signal Light Is:	LIGHT2
Signal Before Feed (seconds)	60
Signal During Feed (seconds)	60
Light Sensor Active	NO

- **Sunrise Time (minutes):** The amount of time required for the light intensity to rise from 0% to the designated level.
- **Sunset Time (minutes):** The amount of time required for the light intensity to decline from the designated level to 0%.
- **Allow Spiking from Day:** The day spiking begins.
- **Spike Cycle (minutes):** The time length that the spike is at its maximum level. Reaching the maximum level and returning to the preset level both take one minute. For example if the spike duration is 10 minutes, the spike cycle is 8 minutes.
- **Spike Durations (minutes):** The total amount of time of the spike cycle, including the rise and fall times.
- **Spike Increase Amount:** Set the increase in intensity for the spike in relation to the current light intensity.
- **Signal Light Is:** Only one light operates during feeding times. Select which light is lit or choose "None".

NOTE: *After the feeding period ends, all lights selected in the Light Parameters screen relight.*

- **Signal Before Feed (seconds):** Amount of time, before the feeding starts, that all other lights go off.
- **Signal During Feed (seconds):** Amount of time that the selected light remains on after feeding ends.

NOTE: The above two parameters are disabled on no feed days.

- **Light Sensor Active:** The light sensor turns off all lights when sufficient outside lights exists. If a light sensor is installed, enable this option to turn off the light during feeding time when there is sufficient outside light. Refer to Light Sensor Calibration, page 97 for details.

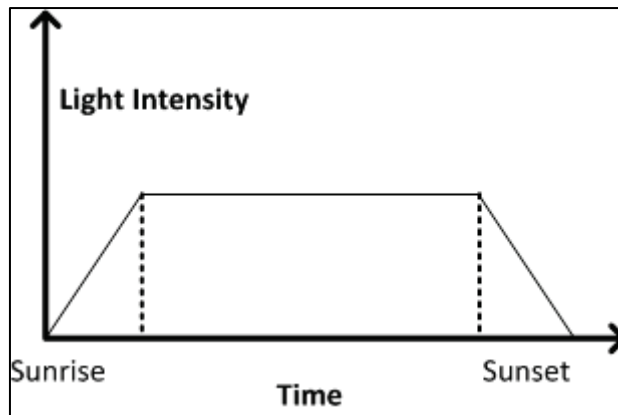

Figure 6: Lighting without Spiking

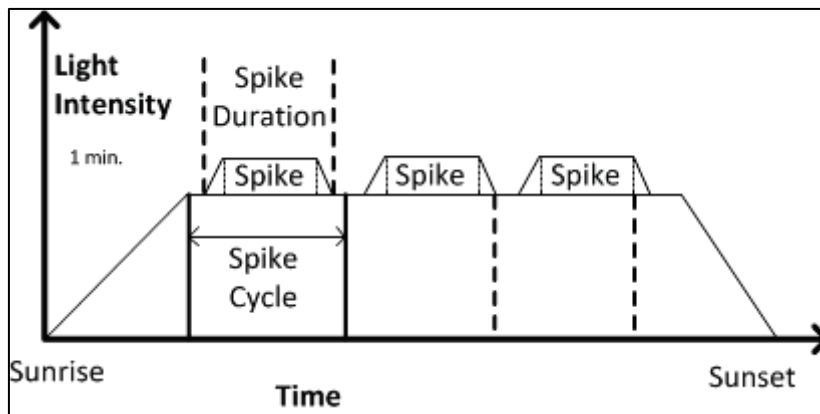

Figure 7: Lighting with Spiking

NOTE: The initial reference time for the Spike Cycle is the end of Sunrise. The spike begins Spike Duration minutes before the end of the Spike Cycle, and has one minute up and down ramps in intensity. If Sunrise Duration is set to zero, no spiking occurs.

4.9 Water & Feed

This menu sets the operating conditions for water and feed devices. There are control two methods:

- Control via Time
- Control via Quantity
- Water and Feed Help | Set Definitions

4.9.1 CONTROL VIA TIME

WATER & FEED							
Day	Time hh:mm	Water		Feeder		Auger	
		1	2	1	2	1	2
1	00:00	✓	▪	✓	▪	✓	▪
12	10:00	✓	✓	✓	✓	✓	▪
25	14:00	✓	✓	✓	✓	▪	✓
46	00:00	✓	✓	▪	▪	▪	▪
48	00:00	▪	▪	▪	▪	▪	▪
0	00:00	▪	▪	▪	▪	▪	▪
0	00:00	▪	▪	▪	▪	▪	▪
0	00:00	▪	▪	▪	▪	▪	▪
0	00:00	▪	▪	▪	▪	▪	▪
0	00:00	▪	▪	▪	▪	▪	▪

- Set the parameters as required
 - Day:** Set growth day. You can define days as negative days. Enter the number and then press the +/-key.
 - Time:** Set event times for water, feeder, or auger. Check marks indicate ON at the event time, and dots indicate OFF. Toggle between check marks and dots with the +/- keys.
 - Water:** Select a check mark to mark water lines to turn on, dot the ones to turn off.
 - Feeder:** Check mark feed lines to turn on, dot the ones to turn off.
 - Auger:** Check mark auger lines to turn on, dot the ones to turn off.
- Set the Water Overflow Alarms and Water Shortage Alarms (page 71).

NOTE: You can implement mealtime, clean up meals and other options similarly as shown earlier in the light programs.

4.9.2 CONTROL VIA QUANTITY

- In *Install > Relay Layout* (page 107), define 1 - 4 relays as an auger.
- In *Scale Menu > Scale Layout* (page 77), map each silo to a channel.
- In *Device Settings > Water & Feed > Help Settings*, enable **Feed by Quantity**.
- In *Device > Water and Feed*, define the parameters as required.
- Set the Water Overflow Alarms and Water Shortage Alarms (page 71).

WATER & FEED										
Day	From Time	To Time	Water		Feeder		Feed			
			1	2	1	2	1	2	3	4
1	00:00	00:30	✓	▪	✓	▪	50	75	0	0
12	10:00	10:30	✓	✓	✓	✓	75	100	0	0
25	14:00	14:30	✓	✓	✓	✓	100	200	0	0
32	14:00	15:00	✓	✓	▪	▪	100	200	0	0
40	14:00	15:30	▪	▪	▪	▪	100	250	0	0
0	00:00	00:00	▪	▪	▪	▪	0	0	0	0
0	00:00	00:00	▪	▪	▪	▪	0	0	0	0
0	00:00	00:00	▪	▪	▪	▪	0	0	0	0
0	00:00	00:00	▪	▪	▪	▪	0	0	0	0
0	00:00	00:00	▪	▪	▪	▪	0	0	0	0

- Day:** Set growth day. You can define days as negative days. Enter the number and then press the +/-key. Growth days stay at the defined parameters until the next defined day.
- From Time/To Time:** Set the time period during which water and feeding lines can operate.
- Water:** Select a check mark to mark water lines to turn on, dot the ones to turn off.

- **Feeder:** Check mark feed lines to turn on, dot the ones to turn off.
- **Feed:** Enter the quantity of feed provided from the silos during the From/To time.
 - You can provide feed from multiple silos, enabling specific feed mixes.
 - Distribution continues until the **To Time** or until the defined quantity is reached, whichever comes first.
 - If a relay is not defined as an auger the Feed numbers still appear. However any quantity entered is meaningless.

Water runs continually between the From/To times. Only feed is distributed in cycles.

NOTE: This function only works when relays are defined as augers and each silo is mapped to an auger. Defining a digital sensor as a feed count does not enable Control by Quantity.

NOTE: If both Control via Quantity and a digital feed counter are enabled, Control via Quantity takes priority.

4.9.3 WATER AND FEED HELP | SET DEFINITIONS

These parameters define the feed and water delivery schedule through the week.

NOTE: The Water and Feed parameters work in conjunction with the Lighting parameters.

- **Feed Day Cycle:**
 - **Daily:** Same schedule for every day of the week.
 - **2 - 6 Days:** Select a cycle that lasts the number of days chosen and then repeats itself. For example, 2 Days means that the cycle lasts two days and then repeats itself.

SYSTEM PARAMETERS			
WATER & FEEDS			
Feed Day Cycle	2 DAYS		
Quantity	YES		
DAYS CYCLE			
Day:	1	2	
Feed:	√		
WATER ON NO FEED DAYS			
Start	Stop	Start	Stop
10:00	10:30	11:30	12:30

- **Week:** Select which days in the week that feed and water are delivered.

SYSTEM PARAMETERS			
WATER & FEEDS			
Feed Day Cycle			WEEK
Quantity			YES
DAYS CYCLE			
Day:	SUN	MON	TUE WED THU FRI SAT
Feed:	√		√ √ √ √
WATER ON NO FEED DAYS			
Start	Stop	Start	Stop
10:00	10:30	11:30	12:30

- **Quantity:** Enable this feature to enable Control by Quantity.

*NOTE: If you choose Daily, the Scale function is always enabled. If you choose 2- 6 Days or Week, the Scale function is **disabled** on non-feeding days.*

CAUTION If you want to provide feed every day, select Daily. Selecting Week and marking each day causes problems with this function.

If you select the 2 - 6 Day schedule or the Week schedule, configure:

- **Days Cycle (2 - 6 Days):** Select which days in the cycle that feed and water is delivered.
- **Week Cycle:** Select the days that feed and water is delivered.
- **Water on No Feed Days:** Select up to two time periods when water is delivered on non-feed days.

NOTE: On feed days, water is delivered when feed is delivered.

4.10 Extra Systems

This menu sets the parameters of other devices that are not listed in the controller.

EXTRA SYSTEMS				
System	1	2	3	4
Start Time	10:30	06:15	14:20	00:00
End Time	18:45	20:30	03:15	00:00
From Temp	75.5	85.5	60	0.0
To Temp	93.0	95.5	98.0	0.0
From Hum.	55	60	60	0
To Hum.	85	85	85	0
On (sec)	45	45	300	0
Off (sec)	300	300	2000	0

- **Start Time:** Time at which this Extra System starts.
- **End Time:** Time at which this Extra System stops.
- **From Temp:** Temperature above which Extra System operates.
- **To Temp:** Temperature below which Extra System operates.
- **From Humidity:** Humidity above which Extra System operates
- **To Humidity:** Humidity below which Extra System operates.
- **On (sec):** On time for the Extra System. If set to 0, the extra system does not operate.
- **Off (sec):** Off time for Extra System after completion of on time. If you have values in both **ON** and **Off**, the extra system cycles. If you have zero OFF time, and any ON time, the system simply stays on as long as the other parameters are satisfied.

NOTE: All parameters must be satisfied for an Extra System to operate. For example if the temperature is below the From Temperature or the Humidity below the From Humidity, the system is OFF. You can assign specific temperature sensors to an Extra System in [Install | Temp Definition](#). The Extra System uses the Inside Humidity, not the Outside Humidity. If there is no humidity sensor, the Extra Systems ignore the humidity parameters.

4.11 Emergency Setting

This selection applies to optional emergency cards. These cards are battery backed, and operate as standard switch and relay cards during normal operation. If an emergency occurs, the cards continue to operate according to their emergency settings.

➔ This function requires installing an Emergency card.

EMERGENCY SETTING				
Relay	Function	Diff	Day	Operate
31	Heat 4	-5.0	10	Min
32	Exh. Fan 1	0.0	20	Vent
33	Tun. Fan 6	2.0	30	Temp.
34	Tun. Fan 7	4.0	0	Temp.
35	Tun. Fan 8	6.0		Temp.

- **Relay:** The Farm Premium determines the relay numbers automatically from the position in the controller in which the Emergency Switch card is installed.
- **Function:** Assign the relay function in [Install | Relay Layout](#). Your selections will likely be different from the example above. The Farm Premium does not allow certain selections for the emergency functions.
- **Differential:** The difference from target temperature at which the device operates during emergency operation.
- **Day:** After this day, the device operates continuously without regard to temperature setting during emergency operation. In this example:
 - Exhaust Fan 1 operates up to the target temperature using the Min Vent timer calculated in [Help | Set](#) on the next page, and continuously above the target temperature. However, from Growth Day 10 forward, the fan operates continuously without regard to temperature.
 - Tunnel Fan 6 is off below 2.0° + Target, and operates continuously if the temperature is more than 2.0° above Target Temperature. However, if the Growth Day is 20 or greater, Tunnel Fan 6 operates continuously without regard to temperature during
- **Operate:** Choose whether the Minimum Vent timer applies to this device or only the temperature differential.

4.11.1 EMERGENCY SETTING HELP | SET DEFINITIONS

- ② While viewing the Emergency Setting menu: Press **HELP**, select **SET**, and press **ENTER**.

SYSTEM PARAMETERS	
EMERGENCY SETTING	
Diff Above Target For Emergency	15.0
Diff Below Target For Emergency	-10.0
Min. Vent On Time Day1 (sec)	30
Min. Vent Off Time Day 1 (sec)	270
Min. Vent On Time Day 21 (sec)	300
Min. Vent Off Time Day 21 (sec)	0
Delay Time to Start Fans (sec)	30

- **Diff above target for emergency:** Set a value above temperature target at which the emergency card enters emergency operation.
- **Diff below target for emergency:** Set a value below temperature target at which the emergency card enters emergency operation.
- **Min. vent on time day 1 (sec):** Set the minimum ventilation on time for 1-day-old birds in this parameter. The card calculates on times between days 1 to 21.
- **Min. vent off time day 1 (sec):** Set the off time for minimum ventilation cycle timer during emergency for growth day 1.
- **Min. vent on time day 21 (sec):** Set the on time for minimum ventilation for three-week old birds.

- **Min. vent off time day 21 (sec):** Set the off time for minimum ventilation cycle timer during emergency for growth day 21.
- **Delay time to start fans (sec):** Set a delay time for the card to wait upon entering emergency before starting fans. This delay gives air inlet devices time to pre-position before they turn on and build static pressure. Otherwise, the static pressure could cause air inlet curtains to stick to wire mesh barriers.

4.12 Water on Demand

The Water on Demand (WOD) function enables regulating the pressure of all nipple lines in the house from one central point, ensuring uniform pressure in all lines. The function also enables immediate transitioning between different preset pressures of all nipple lines in the house by closing and opening of valves at the central point (manual or solenoid according to the mode installed).

Farm Premium enables controlling the water cycle times using relays and controlling the water pressure using analog input and output sensors. The two methods are complimentary. A user can use either one alone or both.

- Relay Control
- Sensor Control

NOTE: The two methods are complimentary.

4.12.1 RELAY CONTROL

You can specify up to 50 time periods.

WATER ON DEMAND					
Day	Time hh:mm	WOD-RLY			
		1	2	3	4
1	12:00	✓	●	✓	●
2	6:00	✓	✓	✓	●
3	8:00	✓	✓	✓	●
5	10:00	✓	✓	✓	●
7	12:00	✓	●	✓	●
9	14:00	✓	●	✓	●

1. In *Installation > Relay Layout* designate up to four relays as WOD valves (relays 179 to 182). Refer to page 107 for details.

2. In *Device > Water on Demand*, configure the following parameters:

- **Day:** Specifies the day to activate the selected WOD valve. You can define days as negative days. Enter the number and then press the +/-key.
- **Time:** Specifies the time to activate the enabled valves. The valves continue running until the next scheduled day and time.
- **WOD Relay:** Enable the required relays.

3. Set the WOD alarms in *Alarm Setting Help | Set Definitions*, page 70.

4.12.2 SENSOR CONTROL

NOTE: When using sensor control, WOD status appears on the Main Screen, Hot Screen 7, and Hot Screen 0.

WATER ON DEMAND						
Day	Time hh:mm	WOD-RLY				Press IN. W.C
		1	2	3	4	
1	12:00	✓	●	✓	●	30.00
1	16:00	✓	✓	✓	●	20.00
3	8:00	✓	✓	✓	●	15.00
5	10:00	✓	✓	✓	●	10.00
7	12:00	✓	●	✓	●	10.00
9	14:00	✓	●	✓	●	5.00

To add precision measurements:

1. To control the water valve opening, In *Installation > Analog Output*:
 - a. designate one output device as Water on Demand Precision.
 - b. set the minimum input and output voltages.
2. In *Installation > Analog Sensor*, designate one sensor as **Water of Demand Pre**. This setting enables a sensor to measure the water flow.
3. In *Device > Water on Demand*, configure the following parameters:
 - **Day:** Specifies the day to activate the selected WOD valve. You can define days as negative days. Enter the number and then press the +/-key
 - **Time:** Specifies the time to activate the enabled valves. The valves continue running until the next scheduled day and time.
 - **WOD Relay:** Enable the required relays.
 - **Pressure:** Specifies the required water pressure. The unit that appears is the unit defined in *Installation > Setup (pressure unit)* (page 106).
4. In *Device > Water on Demand > Help* set the parameters (optional).
5. In *Service > WOD Calibration*:
 - a. Enter the first pressure and voltage data points.
 - b. Repeat for second data point.
 - c. Set the Help definitions (optional, refer to WOD Calibration Help | Set Definitions, page 104).
6. Set the WOD alarms in Alarm Setting Help | Set Definitions, page 70

4.12.3 WATER ON DEMAND HELP | SET DEFINITIONS

SYSTEM PARAMETERS	
WATER ON DEMAND – NIPPLE FLUSH	
Water Pres. During Flush:	0
Relay Active During Flush:	0

- **Water Pressure During Flush:** Designate the system water pressure when nipple flush is operative.
- **Relay Active During Flush:** Designate which WOD relays remain active during flushing.

4.13 Natural Program

The Natural Program enables supplying the house's air requirements using the wind. Using the Natural Program depends on a variety of environmental and scheduling factors. While in this mode, curtains open and close based on the target temperature.

Setting up the Natural Ventilation is a multistep process.

- Preliminary Steps
- Defining Natural Conditions
- Defining Natural Operation
- Natural Programming Help | Set Definitions

NATURAL PROGRAM	
NATURAL CONDITIONS	
From Day	1
To Day	50
From Time	0:00
To Time	0:00
Low Out Temp Target Diff	-10.0
High Out Temp Target Diff	5.0
Min Wind Speed to Enter	2.0
Max Wind Speed to Exit	10.0
NATURAL OPERATION	
Low Temp Diff (Curt Min Pos)	1.0
High Temp Diff (Curt Max Pos)	6.0
Step size	10
Stage Delay (sec)	300
Min Curtain Position	15
Max Curtain Position	100
Wind and Rain Effect	YES

4.13.1 HOW DOES NATURAL VENTILATION WORK

For Farm Premium to switch to Natural Ventilation:

- Natural Ventilation works only during the defined growth days and daily schedule.
- The temperature inside the chicken house must be within the inside temperature band.
- The temperature outside the chicken house must be within the outside temperature band.
 - If the temperature is below either of the above two parameters, ventilation switches to Minimum.
 - If the temperature is above either of the above two parameters, ventilation switches to Tunnel (there is an option to remain in natural ventilation; refer to Minimum Wind Speed for Tunnel Temp).
- The wind speed must be within the wind speed band.
- The wind direction must be within the user-defined area.

NOTE: Including the wind speed and direction in Natural Ventilation calculations is optional and requires in the installation and configuration of additional equipment.

- If the weather conditions meet the above requirements, curtains open to a calculated position based on the **difference temperature** and **minimum** and **maximum** percentage. If more air is required, the curtains adjust themselves automatically using a calculation based on the minimum and maximum curtain position. The larger the difference between the minimum and maximum openings, the larger the step.
- Any change in the curtain position takes place after the Delay Time.

4.13.2 PRELIMINARY STEPS

- Install a wind speed and rain detector (optional).
- Install a wind direction sensor (optional).

1. In *Installation > Setup > Natural Ventilation*, select:

- **Program:** This option uses the parameters listed below to determine curtain opening.
- **Level:** This option instructs the controller to run Natural Ventilation using the levels shown in *Device Settings > Vent and Curtain Levels*. If you choose this option, no further setup is required.

2. If you installed a wind speed and rain detector, in *Installation > Digital Sensors*, define the sensors accordingly.

3. If you installed a wind direction sensor:

a. In *Installation > Analog Sensor*, define the sensor accordingly.

b. If required, calibrate the wind direction sensor (refer to Wind Direction Calibration, page 104).

c. In *Installation > Vent/Curtain Setup*, define the each curtain's direction. When making Natural Program calculations, the controller only takes into consideration winds coming from a certain direction. Any wind whose source is outside of this area is disregarded.

The number entered here defines the area (the number entered $\pm 90^\circ$) (Figure 10).

- If you enter 90, the range is from 0 - 180°
- If you enter 45, the range is from 315 - 135°

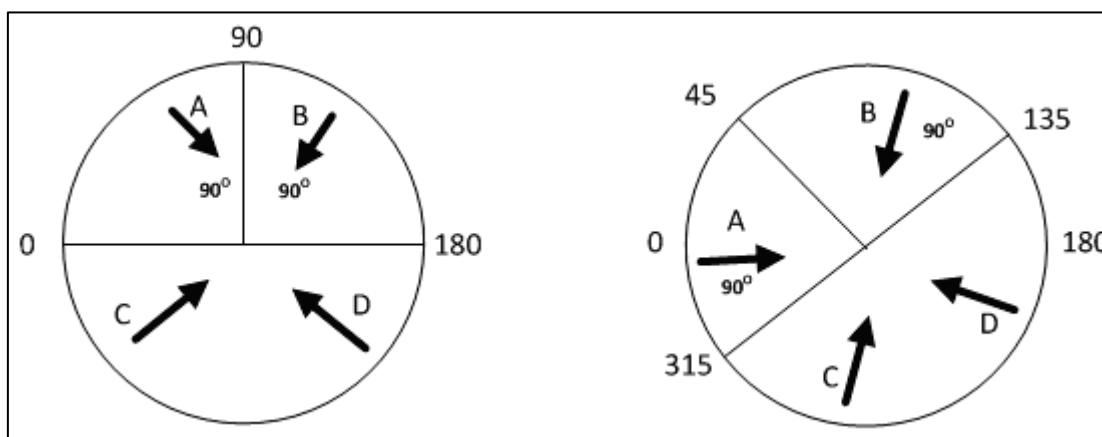

Figure 8: Wind Direction Sensor Definition

CAUTION In both cases, winds A or B would be factored into the calculations whereas winds C or D would not. Only calibrate the sensors if you have reason to believe that they are producing inaccurate results.

The number entered here defines the area on both sides of the sensor! Figure 10 illustrates a chicken house with four wind sensors. Sensor 1's Wind Direction parameter is defined as 45° or 90° total. Winds that come within this area (A) are used for Natural Programming. The controller disregards winds outside of this area (B & C).

4. If required, in *Installation > Temperature Definition* designate a temperature sensor as an outside sensor.

4.13.3 DEFINING NATURAL CONDITIONS

Natural Conditions define when the controller switches to Natural Ventilation. Set the following parameters:

- From/To Day: Sets start and end day for the Natural Program
- From/To Time: Sets starting and finishing time for the Natural Program
- Low Outside Temperature Target Difference: The band below the Current Target Temperature in which Natural Programming operates (**outside temperature**). Range: -20 to +20° C.
- High Outside Temperature Target Difference: The band above the Current Target Temperature in which Natural Programming operates (**outside temperature**). Range: -20 to +20° C.
- Minimum Wind Speed to Enter: Sets the wind speed required to enter Natural Program.
- Maximum Wind Speed to Exit: Sets wind speed required to exit Natural Program.
- Minimum Wind Speed for Tunnel Temp: When the unit is in Natural Mode, if the temperature rises above the Tunnel Temperature, Farm Premium switches to Tunnel mode unless the wind speed is **above** the speed set here.

NOTE: The above three parameters require installing and configuring a wind speed sensor.

4.13.4 DEFINING NATURAL OPERATION

Natural Operation defines how the controller functions in Natural Ventilation.

- Low Temperature Difference: The band below the Current Target Temperature in which Natural Programming operates (**inside temperature**).
- High Temperature Difference: The band above the Current Target Temperature in which Natural Programming operates (**inside temperature**)
- Step size (%): Sets each levels step increment
- Curtain delay time: To prevent excess switching between steps, set a delay time.
- Minimum Curtain Position: Sets the minimum curtain position.
- Maximum Curtain Position: Sets the maximum curtain position.
- Wind and Rain Effect: Enables Farm Premium to consider additional parameters (found in the Help) when calculating the maximal curtain opening.

4.13.5 NATURAL PROGRAMMING HELP | SET DEFINITIONS

SYSTEM PARAMETERS	
NATURAL SETTING	
Enable Natural In Tunnel	NO
Wind Gust delay Time (sec)	60
Disable Stir Fan above W. Speed	6
Minimum Time in Any Vent Mode	10
Use Tunnel as Natural Curtain	NO
WIND & RAIN EFFECT	
Wind Low speed	4
Wind High speed	8
Wind & Rain Low speed	2
Wind & Rain High speed	6

- Natural Setting
 - Enable Natural In Tunnel: Enables using Natural Ventilation definitions when in Tunnel mode.
 - Wind Gust delay Time (sec): Set the delay time for recalculating curtain movement if the wind speed changes.

- Disable Stir Fan above Wind Speed: Above this speed, Stir Fans cease to operate when in Natural Programming.
- Minimum Time in Any Vent Mode: Minimal amount of time that the controller waits before changing into Natural Programming (from Minimum Ventilation or Tunnel Mode). Similarly, the controller remains in Natural Ventilation for at least this time.
- Use Tunnel in Natural Curtain: Use tunnel curtains when in Natural Programming. When disabled, curtains remain closed.
- Wind & Rain Effect
 - Wind Low speed: Below this speed, curtains open completely. This number must be higher than the Minimum Wind Speed to Enter.
 - Wind High speed: Above this wind speed, the controller lowers the curtain maximum opening percentage to this point.
 - Between these levels, the controller opens the curtain based on a curve.
 - Wind & Rain Low speed:
 - Wind & Rain High speed

4.13.6 NATURAL PROGRAM HOT SCREEN

When the Main Screen is displayed, press **5** to view the Natural Program Hot Screen. The Hot Screen display depends on the Natural Program Status.

4.13.6.1 Ventilation is Not in Natural Mode

When Farm Premium is employing Minimum or Tunnel Ventilation, the Hot Screen displays the conditions needed to enter Natural Mode.

NOTE: The Between Temp parameters can change based on the wind speed. Refer to Minimum Wind Speed for Tunnel Temp, page 60.

NOT IN NATURAL MODE	
Wind Speed	Targ Temp
Wind Dir	Rain
Out Temp	Humidity In
Avg. Temp	Humidity Out
NATURAL MODE ENABLE CONDITIONS	
Between Growth Days	1 - 50
Time Frame	24 hrs
Between Inside Temp	79.0 – 91.0
Between Outside Temp	62.0 – 89.0
Between Wind Speed	11.2 – 22.4

4.13.6.2 Ventilation is in Natural Mode

When ventilation is in the Natural Mode, this screen displays the Natural Operation parameters.

NOTE: *If the Tunnel Curtains are used as Natural Curtains, display the tunnel's state by pressing 5 while the Natural Hot Screen is displayed.*

NATURAL MODE - ACTIVE	
Average Temp	Curt 1 78
Current Pos	100%
Next Step (sec)	0
Step Open Tmp	79
Step Open Pos	100%
Step Close Tmp	75
Step Close Pos	90%
Min Curt Pos	15%
Max Curt Pos	100%
Wind Influence	NO

NOTE: *Step Temp and Step Pos are calculations, not parameters. They display when the conditions under which Natural Mode changes its settings.*

4.13.7 WHAT HAPPENS WHEN THE CONTROLLER TRANSITIONS?

When the controller transitions to or from Natural Ventilation the following changes take place

- **Side/Power > Natural:** Fans stop, curtains open to the calculated position and finally the side inlets close.
- **Tunnel > Natural:** Fans stop, curtains open to the calculated position. When the curtains reach their maximum opening position, the tunnel closes (unless the tunnel mode operates to open in natural Mode).
- **Natural > Side/Power:** The controller automatically calculate most suitable Power Ventilation Level, depending on the Target Temperature and current Inside Temperature
- **Natural > Tunnel:** The controllers automatically calculates the most suitable ventilation level depending on the Target Temperature and current Inside Temperature (minimum or tunnel).

4.14 Feed Scale Program

NOTE: *Broiler Mode supports this function*

Feed Scale enables mixing different types of feeds from (up to) four different silos. The user fills each bin with the required feed type and sets the mixture rations and quantities in Farm Premium. The augers then distribute the feed as defined.

This screen defines:

- the total quantity of feed to be delivered to the birds
 - the auger feed mixture.
1. In *Install > Relay Layout* (page 107), define relays as augers as required.
 2. In *Management > Bird Inventory* (page 66), enter the number of birds.
 3. In *Scale > Scale Layout*, map the feed scales.
 4. Go to *Device > Feed Scale Program*.

FEEDING SCALE PROGRAM						
Day	Feed Per Bird	Silo (%)				Total Feed
		1	2	3	4	
1	0.200	70.0	10.0	10.0	10.0	4000
5	0.300	56.0	22.0	11.0	11.0	6000
12	0.400	0.0	0.0	0.0	0.0	0
20	0.300	0.0	0.0	0.0	0.0	0
0	0.000	0.0	0.0	0.0	0.0	0
0	0.000	0.0	0.0	0.0	0.0	0
0	0.000	0.0	0.0	0.0	0.0	0
0	0.000	0.0	0.0	0.0	0.0	0
0	0.000	0.0	0.0	0.0	0.0	0
TODAY		68.7	29.3	2.0		3636

5. Define:

- **Day:** Define the days at which the feed per bird changes. Farm Premium calculates a feed curve based on these days. You can define the days as negative days. Enter the day number and press +/-.
- **Feed per Bird:** Define the amount of feed per bird/pigs (kilograms) to be distributed. Farm Premium calculates the total amount of feed to be distributed based on this parameter and the Bird Inventory parameters.
- **Silo (%):** If there is more than one silo supplying feed, enter the percentage of the feed package that each silo supplies. Note that by default, Silo 1 supplies 100% of the feed. Any number entered in Silo 2, 3, or 4 is subtracted from Silo 1.
- **Total Feed:** Displays the amount of feed required for that day. This amount is calculated by multiplying the feed per bird by the number of birds in the bird inventory (taking into account any birds culled, died, or moved).
- **Today:** These numbers display the actual amount of feed required for the current growth day. In the example shown above, the growth day is Day 2. Farm Premium calculates the curve from Day 1 to Day 5 and adjusts the numbers accordingly.

4.14.1 FEED SCALE HELP | SET DEFINITIONS

FEED SCALE SETTINGS	
Time [hh:mm]	00:00
Max Portion Weight	25
Max Auger Time [min]	10
Not Empty Time [min]	5
Stop Diff 1 Weight	2.2
Stop Diff 2 Weight	2.2
Stop Diff3 Weight	2.2
Stop Diff4 Weight	2.2
Optimizer	Default
Valve Close Time [sec]	5
Feed Tare [A/D count]	0

• Define:

- **Time:** What time the hopper begins distributing feed to the birds or animals.
- **Maximum Portion Weight:** Enter the feed scale container size.
- **Maximum Auger Time [minutes]:** This parameter sets an alarm for the auger running time. Enter the number of minutes that the auger can run, after which an alarm appears on the Main Screen.

- **Not Empty Time [minutes]:** This parameter sets an alarm for the feed scale container. The container should distribute all of its feed to the feed lines. If feed remains in the container, it could mean that there is a problem (for example, the valve doesn't open). Set the amount of time that feed can remain in the container, after which an alarm appears on the Main Screen.
- **Stop Differential 1/2/3/4 Weight:** After each silo stops supplying feed to its auger line, a certain amount of feed continues to flow. This differential compensates for this excess and ensures that only the required amount gets to the feed container. Enter the approximate amount of feed that can be found in the augers. The number does not need to be exact. In the following feed runs, Farm Premium will correct the amount entered.
- **Optimizer:** This parameter sets the unit's sensitivity to signal noise (caused by a variety of factors). The sensitivity plays a role as the controller stabilizes itself. Greater amounts of noise require faster optimization. To view an indication of the controller's stability, go to *Scale Menu > Test* (refer to page 61) and perform a test. If the number remains stable, slower optimization is indicated. There are three settings; Default, Slower, Faster.

NOTE: Munters recommends leaving this parameter at the default level.

- **Valve Close Time [seconds]:** Set the delay in time, if any, that the valve emptying the feed scale closes.
- **Feed Tare [A/D count]:** This specification is used for certain tests performed by a certified technician.

NOTE: Munters recommends leaving this parameter unedited.

4.14.2 FEED SCALE HOT SCREEN

Press "Right and Up Arrows" to view the Feed Scale Hot Screen.

FEED SCALE STATUS	
Status	Idle
Weight	1000
Auger 1	√
Auger 2	√
Auger 3	●
Valve	√
Feed S. Active	
Feed S. Interlock	
Hopper	Open
Intermediate	Open
Alarm	0N

This screen shows the status of different areas of the feeding apparatus. illustrates the system components.

- **Status:** Shows the feed scale status: Idle, Emptying, or Filling.
- **Weight:** Shows the feed scale container weight.
- **Auger 1/2/3/4:** Shows if the auger is running (√) or closed (●)
- **Valve:** Shows if the valve emptying the feed scale is open.
- **Feed S. Active:** This field shows which controller is managing the feed scale.
- **Feed S. Interlock:** The Feed Scale Interlock is a digital sensor which detects which damper is active.
- **Hopper:** The hopper is a digital sensor which detects if the feed has reached the maximum level in the feed bin. Define this sensor in *Install > Digital Sensor*. This screen shows the sensor's current status. If the feed reaches the maximum amount, an alarm is triggered.

- **Intermediate:** The intermediate sensor is a digital sensor which detects if the feed has reached the maximum level in the feed bin. Define this sensor in *Install > Digital Sensor*. This screen shows the sensor's current status. If the feed reaches this sensor, an alarm is generated.
- **Alarm:** This parameter shows if there are active alarms. View the alarms on the Main Screen.

5 Manage Menu

The following sections detail the Management Menu.

- Inventory, page 66
- Feed Inventory, page 67
- Time & Date, page 68
- Growth Day & Flock, page 68
- Alarm Setting, page 69
- Alarm Reset, page 72
- Fail Safe Setting, page 73
- Password, page 74
- Relay Current, page 74



Figure 9: Broiler/Layers Device Menu



Figure 10: Pigs Device Menu

5.1 Inventory

Maintain your inventory by entering data into the controller.

BIRD INVENTORY			
	Male	Female	Total
Add Dead Birds	0	0	0
Add Culled	0	0	0
Birds Moved	0	0	0
Birds Placed	10000	5000	15000
Today's Dead Birds	35	33	68
Today's Culled	12	10	22
Total Dead Birds	35	33	68
Total Culled	12	10	22
Total Birds Moved	1020	510	1530
Bird Count	8933	4447	13380

Figure 11: Broilers/Layers Inventory Screen

ANIMAL INVENTORY			
	Male	Female	Total
Add Dead Animals	0	0	0
Add Culled	0	0	0
Animals Moved	0	0	0
Animals Placed	10000	5000	15000
Today's Dead Animals	35	33	68
Today's Culled	12	10	22
Total Dead Animals	35	33	68
Total Culled	12	10	22
Total Animals Moved	1020	510	1530
Animals Count	8933	4447	13380

Figure 12: Pigs Inventory Screen

- Maintain inventory by entering quantities in the upper half of the screen. There are separate columns for male and female. If you do not wish to keep separate data, simply enter the data into one or the other.
- Initially, enter the number of birds/animals **placed**. Thereafter, enter the quantity found **dead**, **culled** (Add Culled) or **moved** as needed. The Farm Premium shows totals and subtotals in the lower portion of the screen.
- You can correct an error, so long as you correct it on the same day before midnight, by entering a negative quantity (press the +/- key after the number) to subtract the error. After midnight, the information transfers to the [History](#) Menu.

5.2 Feed Inventory

Maintain your feed inventory by entering data into the controller. The software version determines the function's parameters.

FEED INVENTORY					
No.	Date	Silo			
		1	2	3	4
1	2-Jan-08	7800	0	0	0
2	5-Jan-08	0	9000	15000	10000
3	13-Jan-08	8000	0	0	0
4	- -	0	0	0	0
5	- -	0	0	0	0
6	- -	0	0	0	0
7	- -	0	0	0	0
8	- -	0	0	0	0
Total Feed:		15800	9000	150000	10000
ACTIVE		√	√	√	√

To enter feed inventory manually:

1. Type the day of the month and press **ENTER**.
2. Select the month and press **ENTER**.
3. Type the two-digit year and press **ENTER**.
4. Enter the feed quantity under the silo and press **ENTER**. The cumulative total appears in the **Total Feed** row.
6. To delete an entry, change the quantity to zero for all silos and press **ENTER**. Exit the menu and the entry disappears when you enter the menu again.
7. Set the Feed Alarms (page 71).

If you have installed load cells and connected silo scales to your Farm Premium, it automatically maintains feed inventory, including delivery dates and feed consumption data. You can monitor your fill system and maintain approximate feed inventory using the [Digital Inputs](#). In this case, you need to enter your own delivery dates.

This information transfers to the *History > Water and Feed* menus daily, or optionally as often as selected (by the minute) in History View.

5.2.1 FEED INVENTORY HELP | SET DEFINITIONS

② While viewing the *Feed Inventory* menu: Press *HELP*, select *SET*, and press *ENTER*.

SYSTEM PARAMETERS	
FEED INVENTORY	
Total Feed In Silo-1	0
Total Feed In Silo-2	0
Total Feed In Silo-3	0
Total Feed In Silo-4	0
Active Silo	▶ SILO1

- **Total Feed in Silo-1/ -2/ -3/ -4:** Manually change or correct the amount of feed in the silos.
- **Active Silo:** Select the required silo for use. It is possible to select all of them.

5.3 Time & Date

This menu sets the current time and date for the controller.

TIME & DATE	
Current Time	09:19
Date	10-Mar-08
Day of the Week	THURSDAY

- **Current Time:** Enter the current time in 24 hour format.
- **Date:** Enter the date in day-month-year format.
- **Day of the Week:** Select the day of the week from the drop down menu.

5.4 Growth Day & Flock/Group

This menu defines the number of growth days and flock number.

Growth Day & Group	
Current Growth Day	27
Group No.	1
New Group	NO

Growth Day & Group	
Current Growth Day	27
Flock No.	1
New Flock	NO

Figure 13: Pigs Growth Day and Group Figure 14: Poultry Growth Day and Flock Number

- **Current Growth Day:** Enter current growth day, if necessary. It is possible to enter negative growth days up to -2. If you reset the growth day for a new flock using this tool, your old history data does not clear. Use New Flock function to clear out old history in preparation for new birds.
- **Group/Flock No.:** The controller automatically increments the flock number each time you choose New Flock. You can edit the flock number. Since this field accepts six digits, some producers enter a flock number that is made of the day, month and year the birds arrived.

- **New Group/Flock:** Use the new flock function on arrival of a new set of birds to set the growth day back to 1, 0, -1, or -2, and to clear out old history data.

5.5 Alarm Setting

This menu defines the various alarm settings.

ALARM SETTING	
Global Alarm Delay (sec)	1
Alarm Reminder (min., 0-Disable)	30
SENSOR ALARM	
Sensor Low Temp. Range	32.0
Sensor High Temp. Range	122.0
Sensor Alarm-Diff From Lo. Alarm	1.0
Sensor Alarm-Diff From Hi. Alarm	1.0
ALARM	
Alarm Test At Time: (hh:mm)	12:00
Day Of Alarm Test: <input type="checkbox"/>	DAILY
Alarm Test Duration (sec)	0
AUGER OVERTIME ALARM	
Auger Overtime Delay (minute)	15

NOTE: See Fail Safe Setting.

- **Global Alarm Delay (sec):** Alarms without a separate alarm delay, use this global delay before signaling the alarm.
- **Alarm Reminder (min., 0-Disable):** Amount of time before a reminder is sent if the situation has not yet been corrected.

Sensor Alarm

- **Sensor Low Temperature Range:** Sets the minimum reading a sensor can have to be considered a valid sensor reading. Sensor readings below this are rejected. This generates a sensor out of range alarm. This does not apply to the special Circuit Breaker Sensor or Outside Temperature Sensor.
- **Sensor High Temperature Range:** Sets the maximum reading a sensor may have to be considered a valid sensor reading. Sensor readings above this reading are rejected. This generates a sensor out of range alarm. This does not apply to the special Circuit Breaker Sensor or Outside Temperature Sensor.
- **Sensor Alarm-Differential from Low Alarm:** Individual sensor (or zone) alarm if any active sensor reads this much or more below the *Control > Temperature Curve > Low Alarm Temperature* (page 15).
- **Sensor Alarm-Differential from High Alarm:** Individual active growth area sensors alarm if they read this much or more above the *Control > Temperature Curve > Low Alarm Temperature* (page 15).

Alarms

- **Alarm Test at Time:** Schedule the alarm test time.
- **Day of Alarm Test:** Choose **Daily** or a particular **day** of the week for the scheduled alarm.
- **Alarm Test Duration (sec):** Choose the alarm test duration.

Auger Overtime Alarm

- **Auger Overtime Delay:** Set the maximum auger run time for your cross fill system. If you have a monitor connected to the digital inputs programmed as Feeder-1 Overtime or Feeder-2 Overtime the Farm Premium sends an alarm after this delay.
- **Feeder Off During Overtime:** Choose whether to shut the feed systems off after a feeder overtime alarm. Options:
 - **No:** All augers and feeders remain on.
 - **All:** All augers and feeders shut down.
 - **Related:** Only the specific auger from which the alarm originated and its feeders shut down.

NOTE: If you choose *All* or *Related*, the feed system turns off and does not resume until you select [Reset Alarm](#) in the Management Menu.

Feeder Overtime Alarm

- **Feeder Overtime Delay:** Set the maximum feeder run time for your cross fill system. If you have a monitor connected to the digital inputs programmed as Feeder-1 Overtime or Feeder-2 Overtime the Farm Premium sends an alarm after this delay.
- **Feeder Off During Overtime:** Choose whether to shut the feed systems off after a feeder overtime alarm. Options:
 - No: All augers and feeders remain on
 - All: All augers and feeders shut down.
 - Related: Only the specific auger from which the alarm originated and its feeders shut down.

NOTE: This alarm functions in the Broiler mode only.

NOTE: Setting the Feeder Off During Overtime to All in either the Auger Overtime Alarm or the Feeder Overtime Alarm shuts down the augers and feeders, regardless of the other alarm's setting.

Auger Empty Alarm

- **Condition Detection Delay (sec.):** Farm Premium sends an alarm when the current goes to the level set in the following parameter after this delay.
 - **Below Nominal Current:** Send an alarm when the nominal current drops to this level.
- This alarm is operative only if 1) Current Sense Relays are installed and calibrated 2) augers have been calibrated.

5.5.1 ALARM SETTING HELP | SET DEFINITIONS

- ② While viewing the Alarm Setting menu: Press **HELP**, select **SET**, and press **ENTER**.

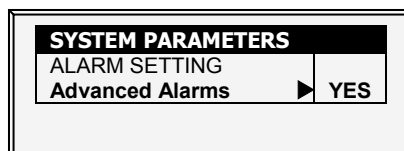

- **Advanced Alarms:** When selecting YES, the following additional alarms appear on the ALARM SETTINGS screen (press MENU and then ENTER to reenter the screen):

Water on Demand Alarms

- **High/Low Pressure Diff (PSI):** Sends an alarm when the difference between the current WOD pressure and the defined pressure reaches these levels. 0 means that the alarm is disabled.
- **Shutdown Pressure Diff (PSI):** Shuts down the Water on Demand system when the pressure reaches this level.
 - Shutdown pressure must be equal to or higher than the High/Low Pressure Difference.
 - However, to disable this alarm set it to 0 (zero), even if the High/Low Pressure is above 0.

Feed Alarms

- **Allow Feed Alarm From/To:** Set a starting time from which the controller can send feed shortage alarms.
- **Low Feed Alarm Limit:** Alarm if feed in Silo 1/2/3/4 is below this limit and time is between From and To limits.
- **Feed Alarm Limit (per hour):** An alarm is generated if the feed flow is greater than this amount. This alarm is activated when a problem arises inside the barn (as opposed to when something happens to the feed scale).

Water Overflow Alarms

- **According to Light Table:** Change overflow alarm level when the lights are off.
- **First Day:** Overflow on the FIRST day applies to the first day operation. You can define a first day at which to start increasing the overflow limit automatically. Days prior to the 'First Day' use the First Day overflow limit; days following the first day have an incremental curve toward the LAST DAY OVERFLOW parameter setting.
- **Overflow on First Day:** Number of gallons/liters per minute that generate an overflow alarm on the first day.
- **Last Day:** Set the last day for the overflow curve.
- **Overflow on Last Day:** Set the maximum overflow limit (gallons/liters) for those days following the last curve day.
- **Overflow At Dark:** Select overflow limit. When it is dark, controller checks every minute.
- **Overflow Alarm Delay:** Define delay time before the controller generates an overflow alarm.
- **Extra Delay At Light Start:** When the first light appears, define the amount of minutes before the controller begins to operate according to the set Overflow for that day.
- **Fogger Water Overflow:** Define the water overflow for foggers (per minute).

Water Shortage Alarms

- **Allow Water Shortage Alarm From/To:** Set the period for which the controller generates water shortage alarms.
- **Shortage During Lights Off:** Select whether water shortage alarm are disabled when all lights are out.
- **Quantity for Shortage:** Minimum flow rate that must be maintained or a water shortage alarm is generated.
- **Shortage Alarm Delay:** Minimum period of time that the shortage must extend through before generating an alarm.

- **Shortage Start Day:** Define on what day shortage alarms begin. This parameter prevents false alarms caused by young birds low water usage. Default: 0 (meaning alarms function normally throughout the growth cycle).

Bird Scales Alarms

- **Allow Bird Scale Alarms From/To:** Set time frame for which the controller begins and ends generating alarms for the bird scale.

Auxiliary Alarms

- Assign auxiliary alarms in the Install menu. Note that digital sensors, auxiliary alarm input with related relay must always match their relay status.
- **Related Relay For Aux Alarm 1/2/3/4:** Relay for Auxiliary Alarm 1/2/3/4.
- **AUX. Alarm Delay (sec):** Separate from the **Global Alarm Delay**. If there is a dry contact, the alarm is sent after the defined **AUX. Alarm Delay**.

Circuit Breaker Alarm

- **Temperature for Circuit Breaker Alarm:** Set circuit breaker alarm temperature.

CO2 Sensor Alarm

- **CO2 High Level:** Set the maximum allowed CO2 level above which an alarm is sent. The alarm ceases when the CO2 drops below this level. If the user acknowledges the alarm, the alarm messages temporarily cease (for the reminder time).

Humidity Sensor Alarm

- **Humidity High Level Alarm:** Set the maximum allowed humidity level above which an alarm is sent. The alarm ceases when the humidity drops below this level. If the user acknowledges the alarm, the alarm messages temporarily cease (for the reminder time).

Ammonia Alarm

- **Ammonia High Level:** Set the ammonia level at which an alarm is sent.

Secondary Alarms

- **Enable Secondary Alarms:** Refer to Prioritizing Alarms, page 72.

Potentiometer Alarm

5.5.2 PRIORITIZING ALARMS

Farm Premium 5.16 enables prioritizing alarms. When enabled:

- ventilation-related alarms are defined as critical. The main alarm relay will transmit these alarms to the device wired to the relay (for example, a dialer).
- non-ventilation alarms are defined as non-critical. A secondary relay will transmit alarms to another device (for example, an ELS).

To prioritize alarms:

1. Go to Install > Relay Layout.
2. Define a relay as Alarm (N.C.).
3. Go to Manage > Alarm Setting > Help
4. Enable Advanced Alarms.
5. Go to Manage > Alarm Setting.

6. Scroll to Secondary Alarms and define as Yes.

5.6 Alarm Reset

This menu functions as an alarm and siren reset.

ALARM RESET		
Alarm Reset		NO
ACTIVE ALARM		NO
No.	Message	SIREN ONLY
1	Switches Ch	YES

Alarm Reset:

- **NO:** Does not reset alarms
- **SIREN ONLY:** Resets only the siren, alarms remain
- **YES:** Resets alarms

Selecting YES:

- Clears the alarm relay for all current alarms. The alarms may remain valid, but the unit does not register new alarms. If a new alarm occurs, or an existing alarm clears and reoccurs, the alarm relay signals again (after any appropriate delay).
- Restores normal operation after an emergency pressure or feed overrun incident. If the controller experiences a high-pressure alarm for too long, it enters emergency pressure operation by opening all known air sources. Curtains open to preset amounts as set in Control | Static Pressure. If you select SIREN ONLY, the alarm relay returns to the no alarm condition, but the emergency pressure status continues.
- Restores normal operation after a feed overrun situation that calls for turning off the feeding system. If the feed monitor senses the cross auger runs too long, it trips a feed overrun alarm and optionally turns off the feed system. If you select SIREN ONLY, the alarm relay returns to the no alarm condition, but the feed overrun status continues.

5.7 Fail Safe Setting

When there is a problem such as extremely high air temperature, the Fail-Safe function immediately activates a backup system (for example the Farm Back Up-27) to ensure that adequate ventilation continues.

FAIL SAFE SETTING	
Alarm Type	Select
High Temp.	✓
Low Temp.	.
Low Static Pressure	✓
High Static Pressure	✓
Avg. Temperature Fail	.
AUX.	.

The Farm Premium has six options besides controller failure or power off to activate the fail-safe relay. Apply the additional settings by using the '+/-' key:

- **High/Low Temperature:** Select to trigger fail-safe when the temperature is exceptionally high/low.
- **Low/High Static Pressure:** Select to trigger fail-safe when the static pressure is exceptionally low/high.
- **Avg. Temperature Fail:** Select to trigger fail-safe when all sensors in house fail.
- **AUX:** Select to trigger fail-safe when auxiliary dry contact occurs.

5.8 Password

PASSWORD	
Owner Password	----
User-1 Password	----
User-2 Password	----
User-3 Password	----
User-4 Password	----
User-5 Password	----
Visitor Password	----

The owner can set new passwords for himself, all users and visitor. The owner cannot see user passwords once entered or changed by the users. The users can access the controller and make changes to all controller settings and their own password. A user can only see and change the user's own password. The visitor can access the controller, but cannot make changes. Each time someone accesses the controller with a password, an event is recorded in the [History | Table of Events](#).

NOTE: *If your controller uses passwords, the controller also requires a password entry to acknowledge switch position changes. If the switch change is not acknowledged the controller signals an alarm.*

5.9 Relay Current

NOTE: *The Relay Current feature supports **single phase electricity** only.*

This menu configures the relay current sense parameters. You can configure:

- the minimum and maximum amperage flowing to the relays
- the relay current alarm
- voltage type

NOTE: *Configuring the amperage is not required. The Farm Premium controller automatically configures default settings.*

RELAY CURRENT SETTING						
Rly.	Function	Min	Nom	Max	Alr	Vlt
31	Heat 6	2.7	3.8	5.0	NO	110
32	Heat 7	2.7	3.8	5.0	NO	110
33	Heat 8	3.0	3.8	5.6	NO	110
34	Exh. Fan 5	2.7	4.3	5.0	NO	110
35	Exh. Fan 6	2.3	3.8	5.0	NO	110
36	Tun. Fan 1	3.0	4.3	5.6	NO	110
37	Tun. Fan 2	0.0	0.0	0.0	NO	110
38	Tun. Fan 3	0.0	0.0	0.0	NO	110

NOTE: Calibrate the relay before configuring these parameters. Refer to *Current Sense Relay Calibration*, page 103. Relays that are not calibrated (or if the relay is not a Current Sense relay) do not display amperage readings (see relays 37 and 38 in the above figure).

To configure the relay current:

1. Using the arrow buttons, select a minimum or maximum amperage setting.
2. Configure the parameter as required.

NOTE: The minimum amperage must be greater than the default minimum and the maximum amperage must be less than the default maximum. For example, relay 35's amperage must be more than 2.3 and less than 5.0 amps.

The Nom amperage is the parameter set when calibrating the relay (refer to page 103).

3. Configure the alarm:

- No: Alarms are not sent in the event of low or high current
- Yes: Alarms are sent in the event of low or high current
- No at zero: The controller sends an alarm if the current is low or high, but not if power is cut off entirely.

4. Configure the voltage: Select 110 or 220 volts.

NOTE: All relays' minimum/maximum current settings per equipment type must be within 30% (\pm) of the nominal value. However, the augers minimum can go down to 0.0 amperes.

5.10 Farm Thermo-5 / Temperature Curve

Munters Farm Thermo-5 is a five stage digital thermostat that works in conjunction with Farm Premium Controllers or as a stand-alone unit. When wired to the Farm Premium, you can use the Farm Premium to set the Farm Thermo-5's stage activation temperatures (which is easier than setting the temperatures on the Farm Thermo-5 screen). The stage activation temperature determines when cooling and heating operations take place. Farm Thermo-5 supports a 10 point temperature curve.

FARM THERMO-5 / TEMPERATURE CURVE						
Day	Temp.	Stage 1 HEAT	Stage 2 HEAT	Stage 3 COOL	Stage 4 COOL	Stage 5 COOL
2	31.0	29.0	26.0	33.0	35.0	37.0
5	33.0	31.0	28.0	35.0	37.0	39.0
7	35.0	33.0	30.0	37.0	39.0	41.0
10	37.0	35.0	32.0	39.0	41.0	43.0

FARM THERMO-5 STAGE DIFF				
Stage 1	Stage 2	Stage 3	Stage 4	Stage 5
-2.0	-5.0	2.0	4.0	6.0

➔ **Wire the Farm Premium communication card to the Farm Thermo-5's communication card. Refer to the Farm Thermo-5 manual for details.**

1. In Install > Communication, define the expansion device as Dig. Thermostat.
2. In Management > Farm Thermo-5 / Temp. Curve, define the parameters (up to a 10 point curve).
 - Day: The growth day
 - Temp.: The target temperature for that day.
 - Stage 1 - 5: The temperatures at which heating or cooling starts (read only)

- Farm Thermo-5 Stage Difference: The differences from the target temperature at which heating or cooling starts at each stage (read only; set these numbers in the Help).

Farm Premium automatically calculates and displays the stage activation temperatures.

CAUTION Verify that the Farm Thermo-5's growth day and the controller's growth day are the same! Days set differently means that the temperature curves will be asynchronous.

3. In Farm Thermo-5 / Temperature Curve> Set Definitions, define the parameters as required.

Notes:

- Farm Premium does not store these temperatures; Farm Thermo-5 does. If you connect the Farm Premium to a different Farm Thermo-5 unit, you must re-enter the temperature curve.
- If you previously defined the temperature curve in the Farm Thermo-5, Farm Premium retrieves the data and you can edit the data in this screen.
- When connecting the RDT-5 to a Farm Premium Controller:
 - If a Farm Premium Extension box is currently connected to the Farm Premium controller, a message appears in the Message box when you disconnect the Extension box. However, no alarm is sent out.
 - After configuring the Farm Thermo-5, disconnect the unit from the Farm Premium and reconnect the Extension box. If the Extension box is not reconnected, Farm Premium sends out alarms.

5.10.1 FARM THERMO-5 / TEMPERATURE CURVE | SET DEFINITIONS

- ② While viewing the Farm Thermo-5 / Temperature Curve menu: Press HELP, select SET, and press ENTER.

FARM THERMO-5 STAGE SETTINGS	
Stage 1 Diff	-2.0
Stage 2 Diff	-5.0
Stage 3 Diff	2.0
Stage 4 Diff	4.0
Stage 5 Diff	6.0
Stage 1 Type	HEAT
Stage 2 Type	HEAT
Stage 3 Type	COOL
Stage 4 Type	COOL
Stage 5 Type	COOL

- Define the parameters as required:
 - Stage 1 – 5 Diff: Enter the difference from the target temperature that activates a heater or cooler for each stage. These numbers appear on the Farm Thermo-5 / Temperature Curve screen.
 - Stage 1 – 5 Type: Select Heat or Cool. Each Farm Thermo-5 relay serves as a heater or cooler relay. This parameter enables displaying the relay definition on the screen.

CAUTION Selecting Heat or Cool in this screen does not define the relay; it only displays the relay type. Actual relay definition is done in the Farm Thermo-5 unit, by placing a jumper on certain pins. Meaning: if a relay is defined in this screen as a heater, but the jumper placement defines the relay as a cooler, the relay is a cooler. Refer to the Farm Thermo-5 manual for details.

6 Scale Menu

The following sections detail the weighing functions.

- Scale Layout, page 77
- General Settings, page 77
- Bird Scale Setting, page 79
- Silo Setting, page 79
- Bird Curve, page 80
- History, page 80
- Feed Conversion, page 81
- Test, page 82
- Calibration, page 82

NOTE: Many scale functions are supported by Broiler/Layer Mode only.

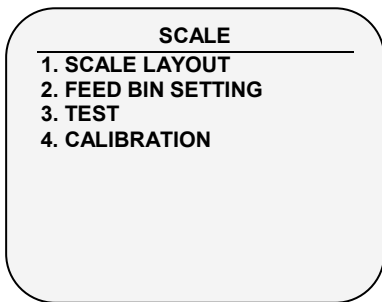

Figure 15: Pig Mode Scale Menu

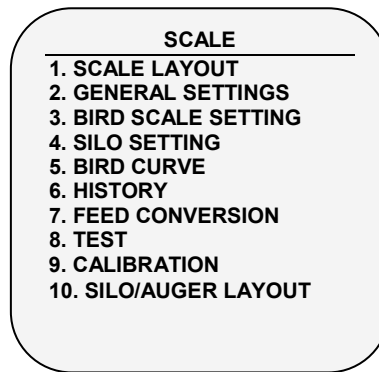

Figure 16: Layer/Broiler Mode Scale menu

6.1 Scale Layout

Use Scale Layout to define the scales or silos connected to the controller.

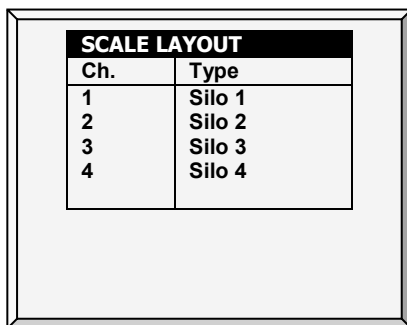

Figure 17: Pig Mode Scale Layout

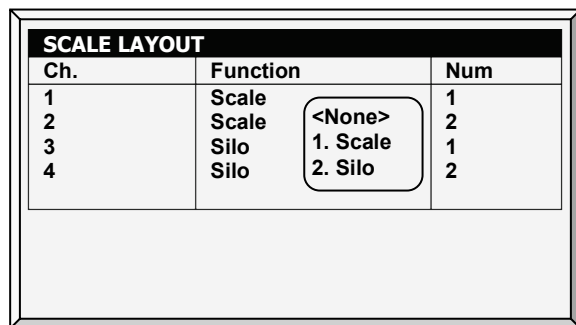

Figure 18: Broiler/Layer Mode Scale Layout

Define the weighing device attached to each channel of the scale option card.

6.2 General Settings

This menu sets general weighing parameters.

NOTE: Only Broiler/Layers Mode supports this function.

GENERAL SETTINGS	
Bird Scale Mode ▶	SEXED
Uniformity Range (5-30%) ▶	10
Curve Selector (for mixed) ▶	BROILER
Weigh During Feed Days	NO

SEXED
MIXED

BROILER
TURKEY
BREEDER

- **Bird Scale Mode:** Select the weighing method:
 - **SEXED:** Considers all birds to be the same sex or 'unisex' as in mixed broilers. It computes its own reference weight or acceptable range from the weighed birds.
 - **MIXED:** Considers the flock to be mixed males and females, with the goal of identifying each bird weight as male or female, which is, classifying it according to a pre-programmed pair of expected weight curves.
- **Uniformity Range (5-30%):** Controller classifies bird weights within this percentage of the average as uniform. Default is 10%.
- **Curve Selector (for mixed):** There are three standard pairs of pre-programmed weight curves. If you use the mixed weighing method, edit the curves to match your expected growth profile (**BROILER**, **TURKEY**, or **BREEDER**).
- **Weigh During Feed Days:** Allow weight data to be recorded on feed days. When set to **NO**, this data is discarded. Default: No

6.2.1 GENERAL SETTINGS HELP | SET DEFINITIONS

- ① While viewing the *General Settings* menu: Press **HELP**, select **SET**, and press **ENTER**.

BIRD CURVE	
Factory Default Curve	No

- **Factory Default Curve:** Select **YES** to return bird curves to the factory default settings

6.3 Bird Scale Setting

NOTE: Only Broiler/Layers Mode supports this function.

There are two different weighing options available; select the option in *Scale > General Settings*.

BIRD SCALE SETTING - SEXED	
Start Time	18:00
End Time	19:00
Range - (0 - 100%)	30
Reference Weight 1	0.13
Reference Weight 2	0.11

BIRD SCALE SETTING - MIXED	
Start Time	18:00
End Time	19:00
Range - (0 - 100%)	20

- **Start Time:** Set the hour you would like the scale to begin weighing
- **End Time:** Set the hour you would like the scale to stop weighing
- **Range - (0-100%):** Band above and below reference weight
- **Reference Weight 1:** Starting out weight for scale 1
- **Reference Weight 2:** Starting out weight for scale 2

6.4 Silo Setting

These settings help you monitor your silo through weighing. There are two events that take place, emptying (feeding) and filling (loading).

NOTE: Silos must be defined in *Scale Layout* for the following parameters to be functional.

SILO SETTING	
Minimum Empty Weight	20
Minimum Filling Weight	2000
Filling Detection Weight	300
Resume Time (minute)	5

- **Minimum Emptying Weight** (Default: 20 Kg): Define the accumulated emptying weight from the bin during feeding time for it to be recorded as an event. Once it has been recorded, the counter resets.
- **Minimum Filling Weight** (Default: 2000 Kg): Define weight required to be filled during loading to be recorded in **History - Feed**; **History - History View**; **Scale - Feed Conversion**.
- **Filling Detection Weight** (Default: 300 Kg): Define the weight you want your controller to detect a filling to stop augers.
- **Resume Time (minute)** (Default: 5 min.): Once loading is completed, define the time you want your controller to count down for the augers to resume normal operation.

The following is a typical scenario:

A loading truck will come to fill the bin or silo. Define the **Filling Detection Weight** to stop the augers from operating during a loading event (Default: 300 Kg). Next, a **Minimum Filling Weight** needs to be defined in order to have the filling event recorded in the **Feed Inventory** (Default: 2000 Kg). Once the loading of the feed is finished, the timer begins to count down for the augers to resume normal operation (**Resume Time**, Default: 5 minutes) and for the filling event to be recorded as completed.

6.5 Bird Curve

This screen displays data according to growth day for **broilers, turkeys, or breeders**, previously set in General Settings.

NOTE: Only Broilers/ Layers Mode support this function.

BIRD CURVE		
Day	Female Weight	Male Weight
1	0.11	0.13
7	0.31	0.35
14	0.66	0.70
21	1.26	1.54
28	2.07	2.73
35	3.15	4.27
42	4.45	6.15
49	5.95	8.22
Now	1.87	2.44

Edit the growth days and weights for the bird curves to fit individual preference.

6.5.1 BIRD CURVE HELP | SET DEFINITIONS

- ① While viewing the *Bird Curve* menu: Press **HELP**, select **SET** and press **ENTER**.

BIRD CURVE	
Bird Curve Offset	0.2

- **Bird Curve Offset:** Enter the factor used to adjust the weight curve. This amount is added to the "Now" field. Range: 0.0 - 10.0 Kg/Lb.

6.6 History

The scale history shows bird weight statistics. You can review daily data for each scale, or separately. The unit records up to two-bird scale data; if you have more than one scale-1 or one scale-2, their data is combined.

NOTE: Only Broiler/Layers Mode supports this function

HISTORY					
Day	Avg.	NO.	S.D.	Unif.	C.V
17	0.000	0	0.000	0	0
18	0.000	0	0.000	0	0
19	0.000	0	0.000	0	0
20	0.000	0	0.000	0	0
21	0.000	0	0.000	0	0
22	0.000	0	0.000	0	0
23	0.000	0	0.000	0	0
24	0.159	1	0.000	100	0
25	0.000	0	0.000	0	0
26	0.000	0	0.000	0	0

- If you selected **SEXED** weighing, the history includes average data for the combined scales, and on the next screens separate data for each scale.
- If you select **MIXED** weighing, the history includes average data for all birds, and separate male and female data for Scale 1 and for Scale 2.
 - Use the arrow keys to scroll to the separated scale data, or up and down for data that is off screen.
 - The average and the number of weights are the usual definition. The Standard Deviation is the usual biased estimator (see a suitable textbook on statistical measurements). The Uniformity is the industry standard 10% uniformity (number of birds per 100 within 10% of the average weight), and the Coefficient of Variation or C.V. is the normalized standard deviation (standard deviation divided by average times 100 %.)

6.7 Feed Conversion

This screen displays the amount of feed converted into the bird's weight.

NOTE: Only Broiler/Layers Mode supports this function.

FEED CONVERSION			
Day	Bird Weight	Daily Feed	Feed Conversion
17	0.00	0	N/A
18	0.00	0	N/A
19	0.00	0	N/A
20	0.00	0	N/A
21	0.00	0	N/A
22	0.00	0	N/A
23	0.00	0	N/A
24	0.16	0	0.00
25	0.00	0	N/A
26	0.00	0	N/A

6.8 Test

This section is a real time table to show the statuses of all scales connected to the controller.

1. In *Scale > Scale Layout* (refer to page 77), select the required scale types.
2. In *Scale > Test*, test the scales as required.

TEST				
	- 1 -	- 2 -	- 3 -	- 4 -
Type	Scale-1	Scale 2	Scale 3	Scale 4
A/D	2024	2010	1891	1893
Weight	0.222	35.768	0.000	0.000
Status	O.K.	O.K.	O.K.	O.K.

Make sure that all statuses are **O.K.** If any of them show a different status, the scale is not installed properly. Unused positions can also show **O.K.**

6.9 Calibration

This menu calibrates the scales and silos connected to the controller.

1. In *Scale > Scale Layout* (refer to page 77), select the required scale types.
2. In *Scale > Calibration*, calibrate the scales.

CAUTION Do not use scales while calibrating.

6.9.1 SCALE CALIBRATION

1. Follow instructions on the bottom section of the screen.
2. Wait until the progress bar displayed shows 100%.
3. Place a known weight on the scale and enter its weight.
4. Wait until the calibration progress bar reaches 100%.
5. Ensure **"Good Calibration."**

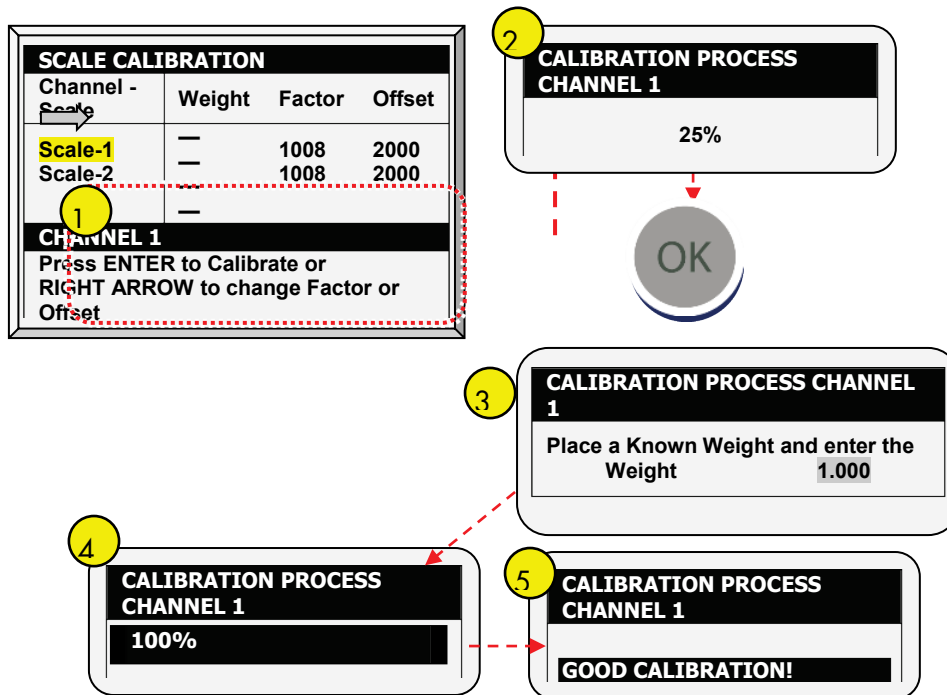

6.9.2 SILO CALIBRATION

1. Follow instructions on the bottom section of the screens.
2. Wait until the progress bar displayed shows 100%.
3. Place a known weight or start filling the silo.
4. Wait until the calibration progress bar reaches 100%.
5. Ensure "Good Calibration."

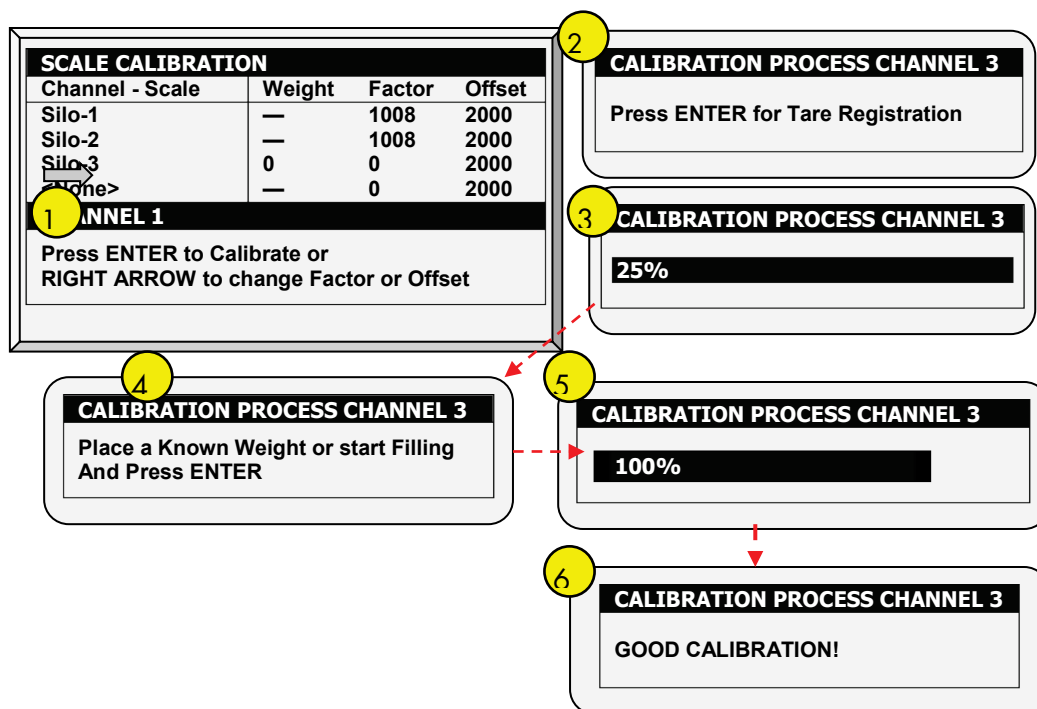

6.10 Silo / Auger Layout

This menu maps augers to a specific silo. Map up to four augers to four silos (one each).

NOTE: Only Broilers/Layers mode supports this function.

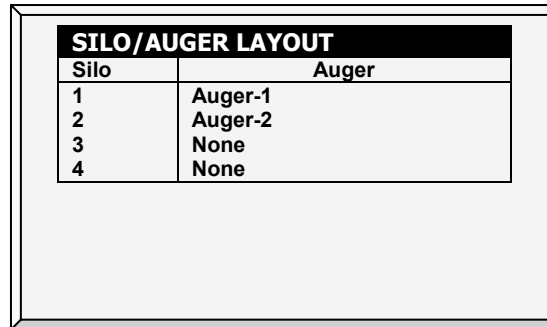

SILO/AUGER LAYOUT	
Silo	Auger
1	Auger-1
2	Auger-2
3	None
4	None

NOTE: Define the silo channel in Scale Layout, page 77.

NOTE: Define the feeding schedule in Water & Feed, page 51.

7 History Menu

In the History Menu you can view data regarding:

- Temperature
- Humidity
- CO2
- Water
- Feed
- Mortality
- Heaters
- Radiant Heaters
- Alarms
- Table of Events
- History View
- Power Consumption



7.1 Temperature

The temperature history menu stores minimum, average and maximum temperatures by growth day. The average is weighted, so if most of the day has been warm the average is closer to the maximum than the minimum.

7.2 Humidity

The humidity history menu stores minimum, average and maximum inside humidity by growth day. The average is weighted, so if most of the day has been humid the average is closer to the maximum than the minimum.

NOTE: If two humidity sensors are installed, this screen displays their average. The History View display shows reading of both sensors only if they have been selected for logging.

7.3 CO2

The CO2 history menu stores minimum, average and maximum inside CO2 levels by growth day. The average is weighed, therefore if most of the day has been high CO2 levels the average is closer to the maximum than the minimum.

7.4 Water

The water menu records daily water consumption and shows the daily differential change from the previous day in percent. You must have the water monitor digital inputs connected. You can monitor up to

two drinking water meters, total drinking water, total water, cool pad, fogger, and cool pad flush consumption.

As an option, you can monitor the water per bird.

1. Go to History > Water > Help.
2. Enable Display History Per Bird.

WATER			
Day	Water P.bird	Water-1	Water-2
1	0.0 (%)	0.0 (%)	0.0 (%)

The screen displays the amount and the percentage change.

7.5 Feed

The feed menu records daily feed consumption and shows the daily differential change from the previous day in percent for silos or fill systems.

➡ **You must install a feed silo weighing system to use the feed system or to monitor the auger system.**

The feed data can be based on one of the following inputs. If more than one input is installed, priority is according to the order of the bulleted list.

- **Silo:** If silos (load cells) are installed, feed consumption data of each bin is based on the silo weight.
- **Current Sense:** If Current Sense Relays for Augers are installed and calibrated (refer to Current Sense Relay Calibration, page 103), feed consumption data of each auger is based on the current sense, calculation method settings, and actual auger run-time. The run-time is calculated based on the measured current, when the actual current is higher than the nominal value (refer to Relay Current, page 74).
- **Feed Count:** If a feed count sensor is installed feed consumption for each feed count input is based on the feed count method settings (refer to Digital Sensors, page 110).

As an option, you can monitor the feed per bird.

1. Go to History > Water > Help.
2. Enable Display History Per Bird.

WATER			
Day	Feed P.Bird Daily	Feed-1 Daily	Feed-2 Daily
1	0.0 (%)	0.0 (%)	0.0 (%)

7.6 Mortality

The mortality history menu maintains daily summaries of mortality, cull, and total dead. It also shows the percentage dead and gives an updated count of bird inventory. The history is maintained separately for male, female and total. Use the left and right arrow keys to switch to the next screen.

7.7 Heaters

The Farm Premium maintains daily total run times of each heater. The table fills several screens; to view the off screen data, use the arrow keys to scroll. The data is in hours:minutes format.

7.8 Radiant Heaters

The Farm Premium maintains daily total run times of each radiant heater, including separate data for low level and high-level heaters. The table fills several screens; to view the off screen data, use the arrow keys to scroll. The data is in hours:minutes format.

7.9 Alarms

The alarm history records the growth day and time of each alarm. Alarms that are currently active show up as flashing on the screen. Alarm history is not reset when using *Management, Growth Date & Flock > New Flock*. The last 250 alarms are saved, and as the table is filled, new alarms push out the older alarms.

7.10 Table of Events

The Farm Premium records significant events with growth day and time stamp. The Table of Events is 1000 events long and is not reset when using *Management, Growth Date & Flock > New Flock*. New events push out the older events.

Typical events recorded are switch changes, entry into tunnel mode, natural or minimum ventilation, alarm resets, ventilation mode changes and more. The Table of Events is an excellent tool to determine whether your controller is going in and out of tunnel due to marginal settings as well as finding and identifying problems.

NOTE: Go to the Table 4, page 118 to view all the available events.

7.11 History View

The History View menu has detailed history on a variety of sensors and data. Go to *Help > Set* under History View to select the particular data to collect.

1. In *Install > Setup > History Resolution*, set the frequency of your data collection. Factory default collects one-hour data on a selection from the choices below.
2. Under **Help | Graph** you can select a variety of graphs of the detailed history.
3. In the **HISTORY VIEW | HELP | SET** menu, set the desired choice by using the '+/-'.

The options are as follows:

- Target Temp.
- House Temperature: Minimum, Average and Maximum
- Temp - 1-9: Minimum, Average and Maximum
- Attic Sensor: Minimum, Average and Maximum
- Outside Temperature: Minimum, Average and Maximum
- Humidity In/Out: Minimum, Average and Maximum
- Water Consumption

- Feed Consumption
- Level of Ventilation

NOTE: *Altering choices erases old data and starts a fresh data set.*

7.12 Power Consumption

This menu displays the daily power consumption (in kWh) of the heaters, fans, lights and other equipment and the change from the previous day.

NOTE: *Current sense relays are required for this function to be enabled (**single phase electricity only**).*

7.13 Ammonia History

This screen displays the minimum, average, and maximum ammonia levels, by growth day.

8 Test Menu

The Test Menu screen shows internal information in order to verify that the Farm Premium is operating correctly. Moreover, it can help find broken wires or any other problems related to it.

- Switches & Relays, page 89
- Alarm, page 90
- Analog Sensors, page 90
- Digital Sensors, page 91
- Analog Output, page 91
- Static Pressure, page 92
- Communication, page 92
- Hardware Checklist, page 93
- Emergency Status, page 93

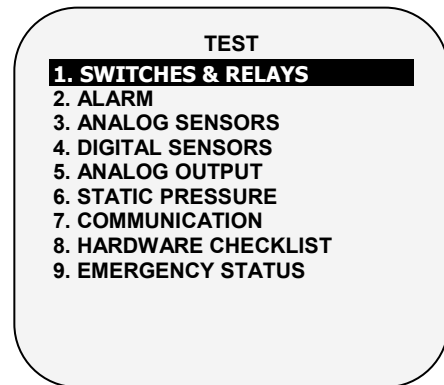

8.1 Switches & Relays

This menu displays a screen of identified switches and relays installed in the controller. Use this option to determine faulty hardware.

The Farm Premium supports a maximum of:

- 20 relays: Farm Premium-P
- 30 relays: Farm Premium-P XL
- 40 relays: Farm Premium/ Farm Premium XL
- 50 relays: Farm Premium XL 50
- Up to 40 extra relays using a Farm Premium Extension

The following screen illustrates a system having 80 switches and relays.

SWITCHES & RELAYS									
01	02	03	04	05	06	07	08	09	10
Aut	Aut	Aut	Aut	Aut	Aut	Aut	Aut	Aut	Aut
11	12	13	14	15	16	17	18	19	20
Off	Off	Aut	Aut	Aut	Aut	Aut	Aut	Aut	Aut
21	22	23	24	25	26	27	28	29	30
Aut	Aut	Aut	Aut	Aut	Aut	Aut	Aut	Aut	Aut
31	32	33	34	35	36	37	38	39	40
On	Aut	On	Aut	Aut	Aut	Aut	Aut	Aut	Aut
41	42	43	44	45	46	47	48	49	50
Aut	Aut	Aut	Aut	Aut	Aut	Aut	Aut	Aut	Aut
51	52	53	54	55	56	57	58	59	60
Off	Off	Aut	Aut	Aut	Aut	Aut	--	--	--
61	62	63	64	65	66	67	68	69	70
--	--	--	--	--	--	--	--	--	-
71	72	73	74	75	76	77	78	79	80
--	--	--	--	--	--	--	--	--	--

8.2 Alarm

Press **Enter** to toggle the Alarm Relay.

- ON means alarms are functioning.
- OFF means alarms are not functioning.

Note that the alarm relay is powered for the 'NO ALARM' condition to provide automatic **Power Fail Alarm** in case of power failure to the Farm Premium. That is, the Normally Open side is closed during NO ALARM.

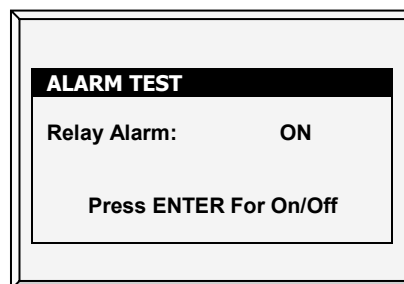

8.3 Analog Sensors

Observe the converter readings for analog sensors with this menu.

- Define sensors in Installation > Analogue Sensors.

ANALOG IN TEST			
In.	Sensor		A/Value
1	Temp. Sensor 1	470	64.0
2	Temp. Sensor 2	426	87.2
3	Temp. Sensor 3	470	85.6
4	Temp. Sensor 4	426	82.0
5	Temp. Sensor 5	470	87.0
6	<None>		
7	<None>		
8	<None>		
9	<None>		
10	<None>		

The readings can vary from 0 to 1023. The values displayed in the 'Value' column indicate that the analog sensor is operating or not according to the following:

- If a very large value is shown (such as a four digit number) or a small value is shown (such as a one digit number): sensor is **not connected**.
- If the unit displays a 3-digit number, usually beginning with the digit '4': sensor is **operating**.

8.4 Digital Sensors

This screen displays the digital sensors states.

➤ Define sensors in Installation > Digital Sensors.

DIGITAL IN TEST			
In.	Sensor	State	Counter
1	Water Meter 1	1	0
2	Water Meter 2	0	0
3	Fogger Water Meter	0	0
4	AUX. Alarm	0	0
5	AUX. Alarm	0	0
6	Low Water Pressure	0	0
7	Wind Speed	0	0
8	<None>	0	0

A '1' implies a shorted input, a '0' an open input. The digital sensors operate with dry contact inputs such as the Arad Water Meter, or micro-switches.

You can apply a short/open input to each channel; the response is then displayed.

NOTE: The water meter quantities appear on the main screen or on Hot Screen 0.

8.5 Analog Output

This screen tests light dimmers, variable speed fans, and variable heaters.

1. Scroll to the required output.
2. Enter the test voltage and verify that the device is operating.

➤ Define sensors in Installation > Analogue Output.

ANAGLO OUT TEST		
Output.	Sensor	0 – 10v
1	Light Dimmer 1	0.0
2	Light Dimmer 2	0.0
3	Light Dimmer 3	0.0
4	Var. Heat	0.0
5	W.O.D	0.0
6	<None>	0.0
7	<None>	0.0
8	<None>	0.0

8.6 Static Pressure

Observe the converter readings for the static pressure sensor. The nominal 'zero' pressure reading is 130. Remove the air hoses from the brass connectors on the left side outside of the controller to check this reading.

STATIC PRESSURE	
A/D Counts	126

8.7 Communication

This menu facilitates testing on communication networks. A multiplexer in loop back mode is used to test the communication. The Farm Premium follows its' own communication to check for failed hardware. Follow the instructions displayed on the screen.

<p>To perform this test you must short RX with TX on the non-priority channel of the multiplexer</p> <p>PRESS ENTER TO CONFIRM</p>
--

8.8 Hardware Checklist

Check the installed hardware that has been identified by the Plug and Play system. The system detects all cards except communication. The standard optional communication card provides lightning protection, and does not have local computerized intelligence to identify itself to the system. Note that if a card is missing, turn the power OFF and then ON for a card rescan.

HARDWARE CHECKLISTE		
Description	Found	Relays
Analog Input	✓	
Digital Input	✓	
Analog Output	■	
Scales	✓	
Static Pressure	✓	
Alarm	✓	
N.C. Emergency Card	1	5
N.O. Switch Card	7	35
N.C. Switch Card	0	0
Vent Board/Curtain Card	0	0

8.9 Emergency Status

This screen displays the emergency cards' status (if installed).

EMERGENCY STATUS	
Emergency Card 1 Temp.	28.4
Emergency Card 2 Temp.	27.7
Set Temperature	24.7
Battery 1 Level	GOOD
Battery 2 Level	GOOD
Min. Vent Cycle On (sec)	57
Min. Vent Cycle Off (sec)	243

- Emergency card sensor temperature
- Current set or target temperature
- Backup battery level
- Minimum ventilation cycle timer ON/OFF time

9 Service Menu

The Service Menu items calibrate various Farm Premium functions.

- Temperature Calibration, page 94
- Humidity Calibration, page 95
- CO2 Sensor, page 96
- Static Pressure Calibration, page 96
- Light Sensor Calibration, page 97
- Feed Calibration, page 98
- Water Calibration, page 98
- Ventilation Potentiometer Calibration, page 98
- Nipple Flushing, page 99
- Feeders & Drinkers, page 100
- Save Settings, page 101
- Load Settings, page 102
- Current Sense Relay Calibration, page 103
- Wind Direction Calibration, page 104
- WOD Calibration, page 104

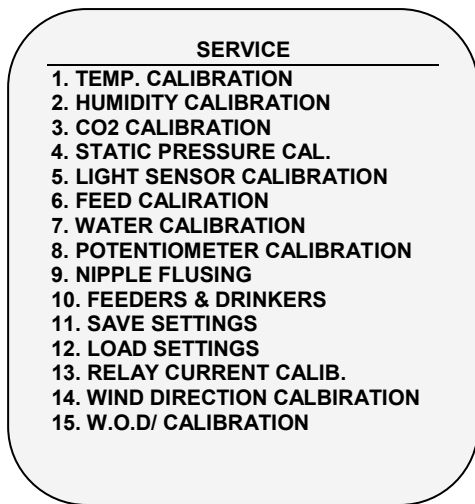

Figure 19: Poultry Service Screen



Figure 20: Pigs Service Screen

9.1 Temperature Calibration

The Farm Premium temperature sensors are typically accurate to approximately 0.5° F within the range of temperatures for poultry production. Calibrate them in this menu by adding/subtracting a constant correction factor to each sensor. Adjust the sensor of your choice with the left/right arrow keys.

TEMPERATURE CALIBRATION		
Sensor	Temp°	Factor
1	78.2	1.6
2	86.4	0.9
3	83.0	-1.5
4	86.2	0.8
5	85.2	-1.6
6	84.2	0.0

Calibrating against infrared or in air temperature sensors generally results in less accuracy than the basic sensors have without calibration.

CAUTION Only calibrate the sensors if you have reason to believe that they are producing inaccurate results.

To calibrate the sensor:

1. Obtain an accurate reference sensors and a pail of water at the approximate required temperature.
2. Stir the reference sensor together with the Farm Premium sensor vigorously in the bucket of water. Keep hands off the sensor itself, so that it responds accurately to the water temperature. Stirring is necessary to preclude stratification within the bucket of water.
3. Call out the accurate reading to a second person standing at the Farm Premium. Walkie-talkie radios may be a good idea.
4. The individual at the controller should double-check that you are calibrating the correct sensor. You might warm/cool the sensor temporarily to see which sensor changes temperature appropriately.
5. Once you determine the correct temperature and allow approximately one minute for stabilization in the water, adjust the sensor reading at the controller.
6. Offset the factor using the left/right arrow keys.
 - Refer to Temperature Curve, page 15.

9.2 Humidity Calibration

To calibrate the humidity level, obtain a suitable humidity test kit and use the procedures described there. They are commonly available via the Internet.

CAUTION Only calibrate the sensors if you have reason to believe that they are producing inaccurate results.

HUMIDITY CALIBRATION		
Sensor	Humidity°	Factor
In	58.9	2.3
Out	N/A	---

Press Left/Right Arrows to Calibrate

- Adjust the Farm Premium reading as needed using the left/right arrow keys.
- Refer to Humidity Treatment, page 24.

9.3 CO2 Sensor

To calibrate the CO2 level, obtain a suitable test kit and use the procedures described in the kit. Ensure that the house is well ventilated, either naturally or using fans.

CAUTION Only calibrate the sensors if you have reason to believe that they are producing inaccurate results.

CO2 SENSOR CALIBRATION	
	Value
PPM at 4 mA/1 VDC	26
PPM at 20 mA/5 VDC	3000
Factor (PPM)	22

CO2 (ppm):
482

- **Ppm at 4 mA / 1 VDC:** Parts per million for 4 mA or 1 VDC
- **Ppm at 20 mA / 5 VDC:** Parts per million for 20 mA or 5 VDC
- **Factor (ppm):** (-/+) ppm shift from the current reading
- **CO2 (ppm):** Current CO2 readings
- Adjust the Farm Premium reading as needed using the left/right arrow keys.
- Refer to CO2 Treatment, page 25.

9.4 Static Pressure Calibration

The Static Pressure should be 0 when there is no ventilation and the house is closed. When the controller A/D counts is 100, this means that there is zero (0) static pressure.

CAUTION: The Static Pressure sensor is factory calibrated. Only calibrate the sensor if you have reason to believe that they are producing inaccurate results.

NOTE: Run Farm Premium for a few hours so that the temperature in the box becomes stable and only then calibrate.

CAUTION DO NOT blow the air into the hose to see of the pressure changes! The sensor is sensitive and blowing air can cause irreparable damage.

To calibrate the Static Pressure Sensor:

1. Disconnect the air hoses.
2. Go to Service > Static Pressure Cal.
3. If the A/D count is 100 +/- 30 (70 to 130), press **Enter**.
4. If the A/D count is less than 70 or greater than 130:
 - a. Check for blocked air hoses or wind interference.
 - b. Adjust the zero pressure reading to approximately 100 by turning the calibration screw.
 - c. When the A/D count is within the permitted range, press **Enter**.

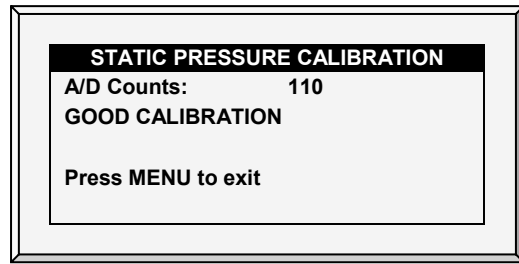
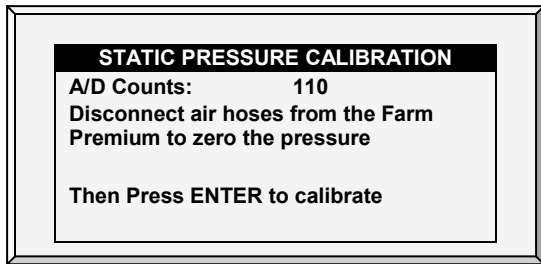

The static pressure sensor is located inside the controller in the upper left hand corner to the left of the power supply.

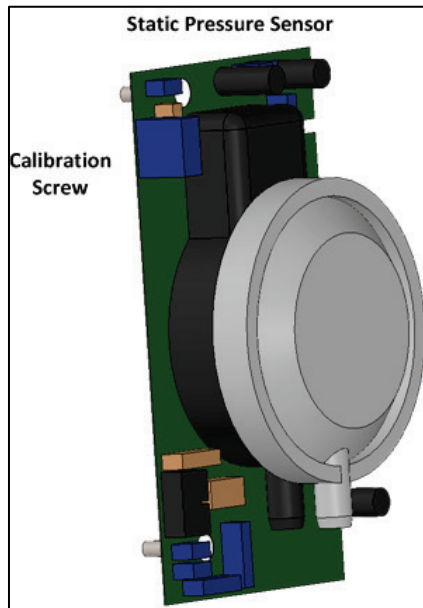

- Refer to Static Pressure, page 31.

9.5 Light Sensor Calibration

NOTE: *Broilers/Layers mode supports this feature.*

Installing a light sensor enables turning off the lights when there is sufficient outside light.

To calibrate the light sensor:

1. Go to *Install > Analog Sensors* (page 109).
2. Define one sensor as a light sensor.
3. Go to *Device > Light* (page 49).
4. Press **Help**, highlight **Set**, and press **Enter**.
5. Scroll down to **Light Sensor Active** and set to **Yes**.
6. Place the sensor in the required location.
7. Go to *Service > Light Sensor Calibration*.
8. When the outside light is bright enough, press **Enter**

9.6 Feed Calibration

Farm Premium can use silo scales or less expensive digital monitoring devices to keep track of your feed. This menu calibrates the digital monitoring devices.

1. Select the feed counting method. Your digital monitoring device may generate a dry contact pulse for each quantity of feed, or it may simply indicate that the feed is running.
2. Enter the quantity of feed per pulse in case you use a dry contact pulse. Otherwise, enter the amount of feed delivered per minute of auger operation.
3. Select one of the following:
 - **Pulse:** Weight per pulse
 - **Time:** Weight per minute
 - **Current Sense:** Motor run time when the auger contains feed
4. Enter quantity (weight per minute or per pulse).

FEED CALIBRATION				
Feed	1	2	3	4
Method	TIME	TIME	TIME	TIME
Factor	2.203	2.203	2.203	2.203

Method Pulse: Weight per Pulse
 Method Time: Weight per Minute
 Method Current: Weight per Minute

9.7 Water Calibration

Farm Premium supports up to four dry contact pulse output water meters. Enter the quantity of water per pulse for your water meters.

WATER CALIBRATION			
Water 1	-	Water Per Pulse	Time
Water 2	-	Water Per Pulse	Time
Cool Pad	-	Water Per Pulse	2.203
Fogger	-	Water Per Pulse	2.203

9.8 Ventilation Potentiometer Calibration

Use this screen to calibrate the ventilation potentiometer control. Potentiometer calibration is required before ventilation can be controlled via a potentiometer.

POTENTIOMETER CALIBRATION				
Pot	Device	Close	Current	Open
1	Vent 1	152	0	1000
2	Vent 2	152	0	1000

➤ Before calibrating the potentiometers:

- Disable the static pressure unit in Install > Setup (page 106).
- Define at least one relay as vent/inlet/tunnel in Install > Relay Outlet (page 107).

- Define at least one analog sensor as a potentiometer in *Install > Analog Sensor* (page 109).

1. Select a potentiometer number.
2. Press **Enter**.

The device relay closes and then opens. As this takes place, the numbers in the Close, Current, and Open columns change. After a few minutes, the process completes and a "Good Calibration" message appears.

NOTE: After potentiometer calibration, the times displayed in the Vent/Curtain Setup screen change. Refer to *Vent & Curtain Levels*, page 41 for details.

9.9 Nipple Flushing

NOTE: *Broiler/Layer Mode* supports this function.

To use this selection, program the water solenoids using the following relay codes:

- **111 Water Main:** The control's supplementary for the usual water line
- **112 Water Bypass:** The control's supplementary to bypass the water pressure regulator
- **113 Water line 1 through 122 Water line 10:** Individual water line supplementary to select the line to flush

During normal operation, only relay 111 water main is active. During flushing relay, code 112 is active together with each of the individual water line relays in turn.

- Configure up to 20 flush times.
- Set start time/duration of water flushing (water lines as defined by relay layout)

NIPPLE FLUSHING		
Start Time	On Time (min)	Status
06:00	2	AUTO
15:40	1	AUTO
00:00	0	AUTO
00:00	0	AUTO
00:00	0	AUTO

9.9.1 NIPPLE FLUSHING HELP | SET DEFINITIONS

- ② While viewing the *Nipple Flushing* menu: Press **HELP**, select **SET**, and press **ENTER**.

FLUSH ORDER							
Line:	1	2	3	4	--	--	--
Order:	1	2	3	4	--	--	--
FLUSHING DAYS							
Day:	Sun	Mon	TUE	WED	THU	FRI	SAT
Flush:	▪	√	√	▪	▪	▪	▪

- **Flush Order:** Set flushing according to line/order
- **Flushing Days:** Set flushing per day using '+/-' key

9.10 Feeders & Drinkers

NOTE: Broiler/Layer Mode supports this function.

This selection enables inserting relevant information regarding feeder and drinker lines.

FEEDERS AND DRINKERS			
Day	Window Pos (%)	Feeder-Line Lift (inch)	Drinker-Line Lift (inch)
15	90	0.0	14.0
20	50	15.0	3.0
0	0	0.0	0.0
0	0	0.0	0.0
0	0	0.0	0.0
0	0	0.0	0.0
0	0	0.0	0.0

- **Day:** Insert day number.
- **Window Pos (%):** Insert the percentage of window's position.
- **Feeder-Line Lift (Inch):** Define the specific feed line lift, measured in inches.
- **Drinker-Line Lift (Inch):** Define the specific drinker line lift, measured in inches.

9.10.1 FEEDERS & DRINKERS HELP | SET DEFINITIONS

① While viewing the *Feeders and Drinkers* menu: Press **HELP**, select **SET**, and press **ENTER**.

FEEDERS AND DRINKERS	
Adjust At Time	12:00
FEEDER WINDOW	
Stop Feed Before Adjust (Min.)	60
Time From Close To Open (sec)	15
FEED LINE	
Movement Time Per 10 inch (sec)	0
DRINKERS LINE	
Movement Time Per 10 inch (sec)	0

- **Adjust at Time:** Set the desired time to adjustment.

Feeder Window

- **Stop Feed Before Adjust (min):** Set the amount of time to stop feeding before adjustment begins.
- **Time from Close to Open (sec):** Set the amount of time after stopping the feeding before opening the feeder's window.

Feed Line

- **Movement Time per 10 inch (sec):** Set a number of seconds needed to move the feed line 10 inches.

9.11 Save Settings

The method used to save the controller's settings to an external memory device is dependent on the hardware employed.

NOTE: *If both a data plug and SD card are inserted, the data plug takes priority and that option appears on the screen.*

- Saving to a Data Plug
- Saving to an SD Card

9.11.1 SAVING TO A DATA PLUG

This menu enables the user to save his program settings to the supplied data plug and transport them to another controller for quick programming.

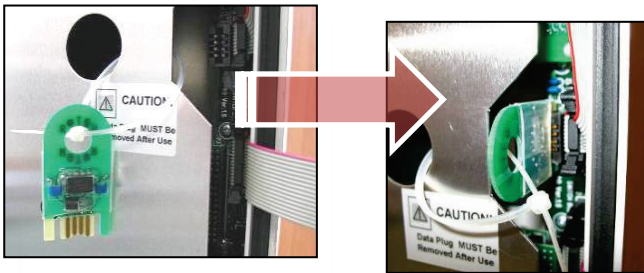

1. **Insert** data plug as shown.
2. **Save** controller settings.

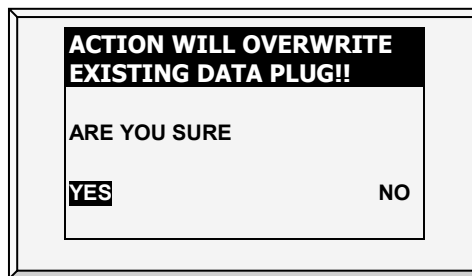

9.11.2 SAVING TO AN SD CARD

This menu enables the user to save the program settings to an SD card and transport them to another controller.

NOTE: *If both a data plug and SD card are inserted, the data plug takes priority and that option appears on the screen.*

- **Verify that the SD card is in place.**
- **The SD card must have at least 20K of free space.**

To save settings:

1. Go to Service > Save Settings.
2. In the screen that appears, select **YES** and press **Enter**.
3. Select the required settings and press **Enter**.
4. Wait for the settings to download.

SAVE TO SD CARD		
1. Setting #1	8-Jan-13	12:00
2. Setting #1	15-Jan-13	12:00
3. Setting #1	23-Mar-13	12:00
4. Setting #1	15-Jun-13	12:00
5. Setting #1	15-Nov-13	12:00
6. Setting #1	01-Jan-14	12:00

9.12 Load Settings

This menu enables reading a saved program from a data plug into the controller quickly and reliably rather than configuring the settings manually.

9.12.1 LOADING FROM A DATA PLUG

- Verify that the program data is identical to the relay layout of the controller.
 - Follow the instructions given on the screen.

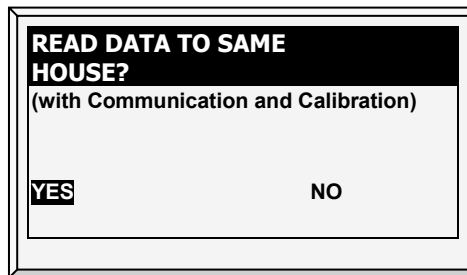
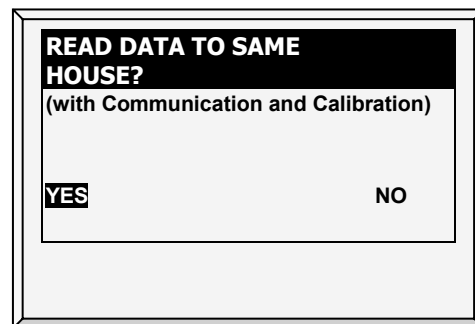
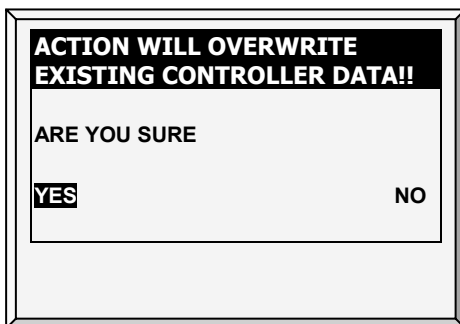

9.12.2 LOADING FROM AN SD CARD

This menu enables the user to load settings saved on an SD card into a controller.

NOTE: If both a data plug and SD card are inserted, the data plug takes priority and that option appears on the screen.

- Verify that the SD card is in place.
- The SD card must have at least 20K of free space.

To load settings:

1. Go to Service > Load Settings.
2. In the screen that appears, select **YES** and press **Enter**.
3. Select the required settings and press **Enter**.
4. Wait for the settings to upload.

READ FROM SD CARD		
1. Setting #1	8-Jan-13	12:00
2. Setting #1	15-Jan-13	12:00
3. Setting #1	23-Mar-13	12:00
4. Setting #1	15-Jun-13	12:00
5. Setting #1	15-Nov-13	12:00
6. Setting #1	01-Jan-14	12:00

9.13 Current Sense Relay Calibration

NOTE: The Current Sense relays supports *single phase electricity* only.

This menu calibrates the amount of current that passes through Current Sense relays. Calibration enables configuring the minimum and maximum permissible currents.

To calibrate the current sense relay:

1. Define the relay (refer to page 107).
2. Select Service > Relay Current Cal. The following screen appears.

RELAY CURRENT CALIBRATION			
Relay	Function	Measure	Current ON
31	Heat 6	Start	0.0
32	Heat 7	Start	0.0
33	Heat 8	Start	0.0
34	Exh. Fan 5	Start	0.0
35	Exh. Fan 6	Start	0.0

Warning!!!
The selected equipment will be turned ON now for current reading adjustment WAIT till operation completion for 15 sec Verify that the relay switch is AUTO

3. Select a relay and click **Enter**.

NOTE: Set the relay to Auto.

4. Repeat for each current sense relay.

RELAY CURRENT CALIBRATION			
Relay	Function	Measure	Current ON
31	Heat 6	Done	0.2
32	Heat 7	Done	0.2
33	Heat 8	Done	0.2
34	Exh. Fan 5	Done	3.8
35	Exh. Fan 6	Done	4.3

Warning!!!
The selected equipment will be turned ON now for current reading adjustment WAIT till operation completion for 15 sec Verify that the relay switch is AUTO

5. To set the minimum and maximum voltages, alarms and 110/220 voltage, refer to Relay Current, page 74.

9.14 Wind Direction Calibration

Use this screen to calibrate a wind direction sensor.

- Define an analog sensor as wind direction.

WIND DIRECTION CALIBRATION		
	Direction	Calibration
Wind Direction	6	14.50

9.15 WOD Calibration

- Define an analog sensor as WOD.

WATER ON DEMAND CALIBRATION		
	Volt	Pressure - PSI
WOD 1st Calib.	2.50	14.50
WOD 2nd Calib.	7.50	43.50

READ ME

Enter output voltage for first point.
Enter water meter measure pressure.
Repeat this for the second point.

1. In *Installation > Setup*, set the Length Unit.
 - Metric = Bar
 - Non Metric = PSI
2. In *Service > WOD Calibration*:
 - a. Enter the first voltage and check pressure data points.
 - b. Repeat for second data points.
3. Set the Help Definitions (optional)

9.15.1 WOD CALIBRATION HELP | SET DEFINITIONS

This parameter reduces the water pressure a user-defined factor.

SYSTEM PARAMETERS	
WATER ON DEMAND	
Pressure Reducer Factor	50.00

1. In *Install > Setup*, define the Pressure unit.
2. In *Service > WOD Calibration > Help*, define the reduction factor. Water pressure is reduced by 1/50 (bar or PSI). The factor is accurate to two decimal points.

9.16 Ammonia Calibration

- Define an analog sensor as ammonia sensor.

To calibrate the ammonia level, obtain a suitable test kit and use the procedures described in the kit. Ensure that the house is well ventilated, either naturally or using fans.

- ➡ Only calibrate the sensor if you have reason to believe that they are producing inaccurate results.

AMMONIA CALIBRATION	
PPM at 0VDC	0
PPM at 5VDC	100
Factor (ppm)	0
AMMONIA (ppm) 15	

- Define the following:
 - Ppm at 0 VDC: Parts per million at 0 VDC
 - Ppm at 5 VDC: Parts per million at 5 VDC
 - Factor (ppm): (-/+) ppm shift from the current reading
 - Ammonia (ppm): Current ammonia reading
 - Adjust the Farm Premium reading as needed using the left/right arrow keys.
 - Refer to Ammonia Treatment.

10 Install Menu

The Install Menu items are used when installing input and output devices, as well as configuring critical parameters needed to run your controller properly.

- Setup, page 106
- Relay Layout, page 107
- Analog Sensors, page 109
- Digital Sensors, page 110
- Analog Output, page 110
- Vent / Curtain Setup, page 111
- Temperature Definition, page 114
- Fan Air Capacity, page 115
- House Dimensions, page 115
- Communication, page 116

INSTALLATION	
1. SETUP	
2. RELAY LAYOUT	
3. ANALOG SENSORS	
4. DIGITAL SENSORS	
5. ANALOG OUTPUT	
6. VENT/CURTAIN SETUP	
7. CURTAIN SETUP	
8. TEMP DEFINITION	
9. FAN AIR CAPACITY	
10. HOUSE DIMENSIONS	
11. COMMUNICATION	

10.1 Setup

SETUP	
Ventilation Mode	PRECISION
Language	ENGLISH
Temperature Unit	F°
Pressure Unit	IN.W.C
Wind Speed Unit	METER/SEC
Fan Air Capacity Unit	CFM
Length Unit	NON METRIC
Weight Unit	LB
Growing Zones (1-4)	2
Minimum Vent (Power)	YES
Natural Ventilation	NO
Tunnel	YES
History Resolution	15 MINUTE

Set the following:

- **Language** As required
- **Temperature Unit** Celsius / Fahrenheit
- **Pressure Unit** Milibar / Inches of WC (Water Column) / Pascal / cm of WC / mm of WC / None
- **Wind Speed Unit** Km Per Hour / Mile per Hour / Meter per Sec / Feet per Sec
- **Fan Air Capacity Unit** Cubic feet per minute (CFM) / Cubic meter per hour (M3/H)
- **Length Unit** Meter / Feet
- **Weight Unit** Pounds (LB) / Kilograms (KG)

- **Growing Zones** 1/2/3/4
- **Minimum Vent (Power)** YES (power) / NO
- **Natural Ventilation** YES / NO
- **Tunnel** YES / NO
- **History Resolution** 1 minute / 5 minute / 10 minute / 15 minute / 30 minute / 1 hour / 2 hours

10.1.1 STATIC PRESSURE UNIT DEFINITION

Enabling/disabling a static pressure unit determines the ventilation method used in the chicken/animal house:

- **Static pressure unit enabled:** After selecting any method, refer to Static Pressure, page 31 to define the static pressure parameters.
- **No unit enabled:** If you choose None, ventilation is controlled by time or a potentiometer. Refer to Vent & Curtain Levels, page 41.

10.2 Relay Layout

Use this screen to define the devices connected to the controller.

1. Select the requested choice from the menu list by using the up/down cursor keys (refer to Output Function List, page 108).

NOTE: If required, you can set the relay number manually.

2. If the required code is 100 and above, use the '+/-' keys before selecting and then press a two digit number. For example 135 would be +/-35.
3. To duplicate relays use the 'As Relay # X' where 'X' stands for a relay number defined already in the system.

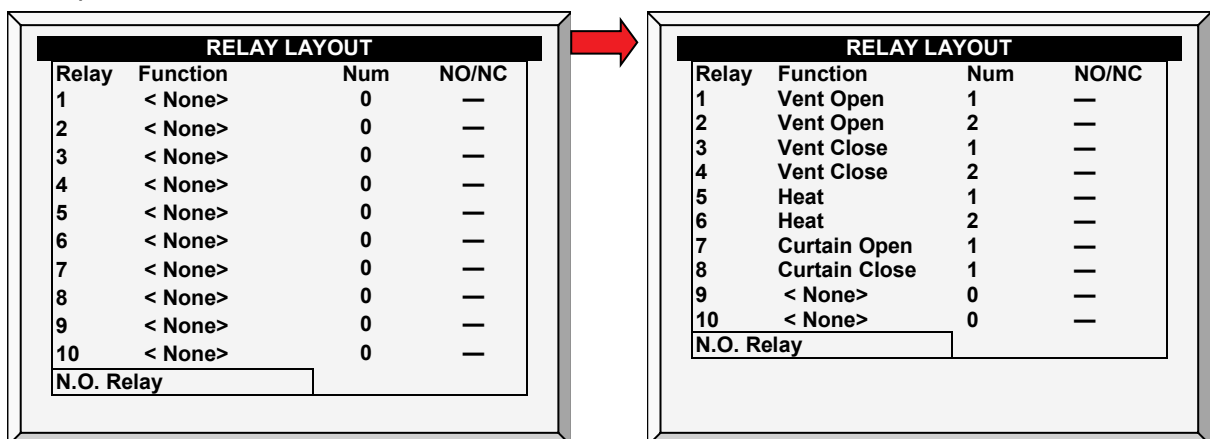

- Enter relays according to equipment installation (I/O list of technician) using up/down arrow keys.
- If you have installed Current Sense relays, Farm Premium defines them automatically. Current sense relays transmit to the user's PC the amount of the current being passed to the relay and send alarms when the current is too low or too high. In addition, you can view the daily electricity consumption in History. Refer to Current Sense Relay Calibration, page 103 for calibration instructions.

10.2.1 OUTPUT FUNCTION LIST

	Relay Name	Quantity Supported
1.	Heaters	16
2.	Radiant Heaters Low	16
3.	Radiant Heaters High	16
4.	Radiant Heaters Ignite	16
5.	Tunnel Fan	30
6.	Exhaust Fan	20
7.	Stir Fan	15
8.	Cooling	4
9.	Cooling Pad	4
10.	Fogger	4
11.	Vent Open	4
12.	Vent Close	4
13.	Tunnel Open	4
14.	Tunnel Close	4
15.	Curtain Open	4
16.	Curtain Close	4
17.	Attic Open	1
18.	Attic Close	1
19.	Vent Speed	1
20.	Light	4
21.	Water	4
22.	Feeder	4
23.	Auger	4
24.	Extra System	4
25.	Alarm (N.C.)	1
26.	Fail Safe (N.C.)	1
27.	Feeder Win Open	1
28.	Feeder Win Close	1
29.	Feeder Line Up	1
30.	Feeder Line Down	1
31.	Drink Line Up	1
32.	Drink Line Down	1

	Relay Name	Quantity Supported
33.	Water Main	1
34.	Water Bypass	1
35.	Water Line	10
36.	WOD	4
37.	AS Relay	8
38.	AS Analog Output	8

10.2.2 RELAY LAYOUT – HELP | SET DEFINITIONS

② While viewing the *Relay Layout menu*: Press *HELP*, select *SET*, and press *ENTER*.

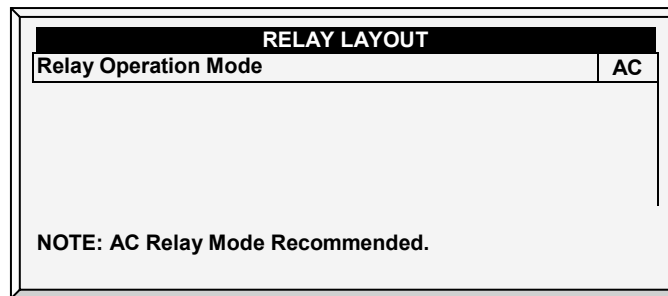

- Define relay operation mode: DC or AC.

NOTE: AC mode produces less heat in the controller box.

10.3 Analog Sensors

➡ Install analog input cards.

This screen enables the user to install the analog sensors. The Farm Premium regards temperature, humidity, and CO2 sensors and circuit breaker as analog sensors. These sensors measure a continuous range rather than just on or off.

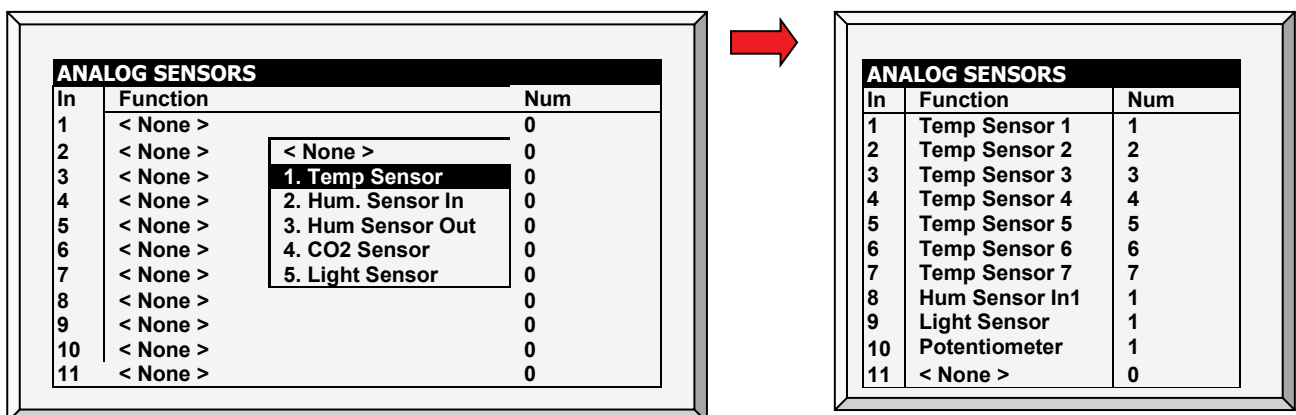

- Enter temperature / humidity sensors wired to each input (setup according to technician).

NOTE: If sensor numbers duplicate, the sensors average.

10.4 Digital Sensors

➤ Install digital input cards.

This screen enables configuring the installed digital sensors. These sensors monitor both water and feed consumption if the building is equipped accordingly. Digital inputs include on/off and pulsing inputs such as auxiliary alarms, pulsing water meters and feed.

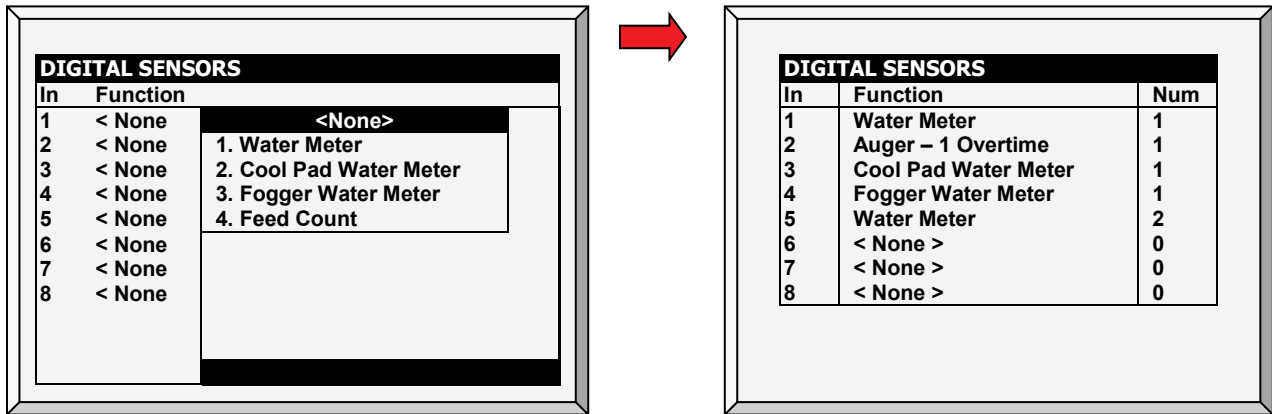

- Enter sensors wired to each input (setup according to technician)
- Farm Premium automatically numbers the sensors according to their function.
 - You cannot define more than the permitted number of any particular sensor. For example, you can define one function as Cool Pad Water Meter, not two.

10.5 Analog Output

Analog output can be used to control:

- Variable speed fans
- Variable stir fans
- Vents
- Curtains
- Light dimmers
- Variable heaters
- Tunnels
- Floor heat (up to two; Pig Mode only)

➤ Install analog output cards.

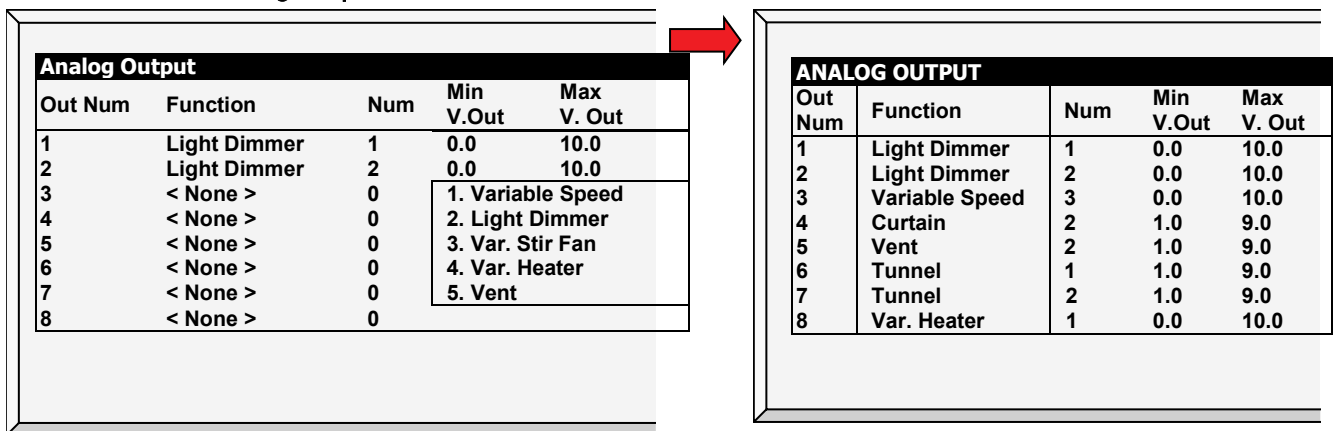

- Enter sensors wired to each input (setup according to technician).
- The above is an example of an analog output configuration.

10.5.1 LIGHT DIMMER, VARIABLE SPEED FAN, VARIABLE HEATER, VARIABLE STIR FAN CONTROL

- To configure the light dimmers, refer to Light, page 49.
- To configure the variable speed fans, refer to Stir Fan Levels, page 43.
- To configure the variable heaters, refer to Temperature Curve Help | Set Definitions, page 16.
- To configure variable speed fans, refer to Stir Fan Levels, page 43.

10.5.2 VENT, TUNNEL, AND CURTAIN ANALOG OUTPUT CONTROL

Vents, tunnels, and curtains can be controlled via:

- A physical relay (device is physically wired to a relay) (refer to page 107) OR
- A analog output (device is wired to an actuator that is connected to the Farm Premium analog output card)

Assigning an analog output to a vent, tunnel, or curtain enables them to open and close **automatically**, according to the analog output.

1. Define an output as vent, tunnel, or curtain.
2. Record the output number.
3. Enter the minimum and maximum voltage outputs according the actuators' requirements.

However, to enable opening and closing manually, a relay must be mapped to the analog output.

NOTE: The following steps are optional.

4. Go to *Installation > Relay Output*.
5. Define a relay as **AS Analog Out (38)**.
6. Place the cursor in the number column and enter the recorded output number.
7. Repeat for each relay.

NOTE: If a vent is operating over analog output, there potentiometer feed-back support is disabled.

10.6 Vent / Curtain Setup

➡ In **Installation > Setup**, define **Static Pressure unit as None**.

Use this screen to define the ventilation opening and closing mechanism. You can use one of three methods:

- Time
- Potentiometer
- Wind Direction (Natural programming only)

If you map a curtain or vent to a potentiometer, the Farm Premium controller uses that method (and not time).

NOTE: After defining the method used, define the opening levels in Vent & Curtain Levels, page 41.

In addition, Farm Guard enables turning off the fans if the curtain is not in the proper position. Refer to Stop Fans, page 113.

10.6.1 USING TIME TO CALIBRATE

Enter the number of seconds to open and close from limit to limit for each of the Vents and Curtains in your installation. The Farm Premium then calculates the percentage of open and closed time and adjusts the static pressure methods accordingly.

VENT / CURTAIN SETUP					
Curtain		Pot	Open (sec)	Close (sec)	Wind Dir
~	Curtain 1	NONE	60	60	45
	Curtain 2	NONE	60	60	45
	Inlet 1	NONE	60	60	0
	Inlet 2	NONE	60	60	0
	Tunnel	NONE	60	60	0
~	Vent 1	NONE	60	60	0
	Vent 2	NONE	60	60	0
	Attic Vent	NONE	60	60	0

- Set full open/full close time (in seconds) for Curtains, Tunnel, 1st & 2nd Vent, and Attic Vent.
- Default is set at 60 seconds.
- Munters recommends setting the [Help parameters](#) to maintain an accurate position.

NOTE: The ~ symbol designates an analog output device.

10.6.2 USING A POTENTIOMETER TO CALIBRATE

Each curtain/vent/inlet can be mapped to a potentiometer. Potentiometer feedback enables precise positioning on each specific device opening value. In this screen, assign a potentiometer to a device.

VENT / CURTAIN SETUP					
Curtain		Pot	Open (sec)	Close (sec)	Wind Dir
~	Curtain 1	POT 1	60	60	45
	Curtain 2	POT 2	60	60	45
	Inlet 1	POT 3	60	60	0
	Inlet 2	NONE	60	60	0
	Tunnel	NONE	60	60	0
~	Vent 1	NONE	60	60	0
	Vent 2	NONE	60	60	0
	Attic Vent	NONE	60	60	0

1. Map the analog sensors as potentiometers as required (Analog Sensors, page 109)
2. Map the curtain/vent/tunnel/inlet to a potentiometer in this screen.

NOTE: The number of the devices that you can map equals the number of potentiometer relays.

NOTE: The ~ symbol designates an analog output device.

3. Calibrate the potentiometer (Ventilation Potentiometer Calibration, page 98).

NOTE: After calibrating the potentiometer, the times shown here change to reflect the calibration process.

In the event that the potentiometer fails (meaning there is no value change during the curtains/vents/inlets movement):

- Alarm message is transmitted

- The specific curtain/vent/inlet mapped to the failed potentiometer starts operating by time calculation, using the times calculated by the calibration process. However, if required you can enter new opening and closing times.

10.6.3 USING WIND DIRECTION

This parameter is enabled only when Natural Ventilation is enabled. Refer to Preliminary Steps, page 59 for details.

10.6.4 STOP FANS

The Stop Fan parameter enables turning off fans if a specific curtain is moving below its minimum position. This function prevents the curtain from sticking if the static pressure is too high and curtains have not yet moved into a position which will cause the pressure to drop.

VENT / CURTAIN SETUP						
Curtain	Pot	Open (sec)	Close (sec)	Wind Dir	Stop Fan	
~ Curtain 1	NONE	60	60	45	NO	
Curtain 2	NONE	60	60	45	NO	
Inlet 1	NONE	60	60	0	NO	
Inlet 2	NONE	60	60	0	NO	
Tunnel	NONE	60	60	0	NO	
~ Vent 1	NONE	60	60	0	NO	
Vent 2	NONE	60	60	0	NO	
Attic Vent	NONE	60	60	0	NO	

NOTE: Default is NO.

10.6.5 VENT/CURTAIN HELP | SET DEFINITIONS

These parameters enable maintaining an accurate curtain position when using time to calibrate.

- ② While viewing the *Vent/Curtain menu*: Press *HELP*, select *SET*, and press *ENTER*.

SYSTEM PARAMETERS	
CURTAIN CALIBRATION	
From Time	0:00
To Time	0:00
Number of Steps	0
Power Vents Calibration	NO
Proximity to Edge %	10
Close Below This Temp. (out)	0.0

- **From/To Time:** Time period in which calibration is enabled
- **Number of Steps:** number of steps for automatic calibration: Set calibration point for curtain after desired amount of curtain opening/closing (steps). During calibration, if the curtain is open more than 50% it opens to 100%, calibrates, and returns to the previous position. If the curtain is open less than 50% it closes to 0%, calibrates, and returns to the previous position. Default: 99.
- **Power Vents Calibration:** This parameter enables automatic calibration of air inlets when recovering from a power outage. In many installations the backup system, such as Munters' FBU-27, may have opened the air sources. When the Farm Premium takes over control again, the air inlets are incorrectly positioned. The calibration at power up feature synchronizes the actual position and the controller.

- **Proximity to Edge %:** Curtain will open or close based on this proximity to the edge. For example, when set to 10%, the curtain closes when the opening is less than 10% and opens completely when the opening is greater than 90%.
 - **Close Below This Temp. (out):** Curtains close when the outside temperature reaches this point.
- ☞ **This parameter requires defining a temperature sensor as an outside sensor (refer to Temperature Definition).**

NOTE: *The Proximity to Edge % parameter takes priority over the Close Below This Temp parameter. Meaning, if the outside temperature mandates closing the curtain, the curtains will still open if they are within the proximity defined in the Proximity to Edge parameter.*

10.7 Temperature Definition

This screen assigns specific temperature sensors for various brood setups and for heater zones. Moreover, assigning sensors to particular devices is possible. Note that if the sensors selection remains blank, the default value is assigned.

Choose 1 to 18 temperature sensors for each item listed by using the '+/-' keys. The house, brooding and tunnel sensors cause the current average to apply to devices when no specific sensor is assigned to them. The current average substitutes for either failed or missing sensors.

NOTE: *Sensors 10 – 18 require installing a second analog card.*

TEMPERATURE DEFINITION	
Function	Temp. Sensor 1 2 3 4 5 6 7 8 9
Full House	√√√
Tunnel
setting
Attic	. . . √ . . .
Outside √ . . .
Stir Fan 1 √ . . .
~ Stir Fan 2 √ . . .
~ Var. Heat 1 √ . . .

- Press +/- key to add/remove ✓ to assign temperature sensors to corresponding function.
- Refer to Temperature Curve, page 15.
- Assign Temperature Sensors as required in *Install > Temp Definition*. Devices that do not accept temperature sensors, such as Exhaust Fans, Tunnel Fans, Feed and Light do not appear.

NOTE: *If you are using two (2) input analog cards, the screen displays Temp. Sensor(s) 1-18 (refer to above screen capture).*

NOTE: *When an attic sensor is not installed, the attic vent is disabled.*

NOTE: *The ~ symbol designates an analog output device.*

Note that Exhaust Fans and Tunnel Fans do not appear because the Ventilation Levels defined in *Device > Levels of Ventilation* control their operation. Stir Fans appear even though the *Device > Stir Fan Levels* apply to them because they simultaneously operate according *Device > Stir Fan Programs* where specific sensor assignments are required in Program B and recommended in Program C.

10.8 Fan Air Capacity

This screen enables defining the fans' air capacity. Insert fan air capacity for both the exhaust and tunnel fans.

FAN AIR CAPACITY	
Fan	CFM
~ Tun. Fan 1	24600
~ Tun. Fan 2	24600
Tun. Fan 3	29400
Tun. Fan 4	29400
Tun. Fan 5	29400
Tun. Fan 6	29400
Tun. Fan 7	29400
Stir Fan 1	29400
~ Exhaust Fan 1	29400
Exhaust Fan 2	29400

1. In *Installation > Relay Layout and/or Installation > Analog Output*, define the fans.
2. In *Installation > Setup*, define the fan air capacity unit.
3. In *Installation > Fan Air Capacity*, define air capacity (default setting shown above).

NOTE: This information enables the display of air capacity for each level in the Levels of Ventilation table.

NOTE: The ~ symbol designates an analog output device.

10.9 House Dimensions

The screen allows the user to set its' house dimensions. Set it according to actual house size. These dimensions are used for calculating the wind chill factor (the chilling effect of the wind that can significantly lower the temperature).

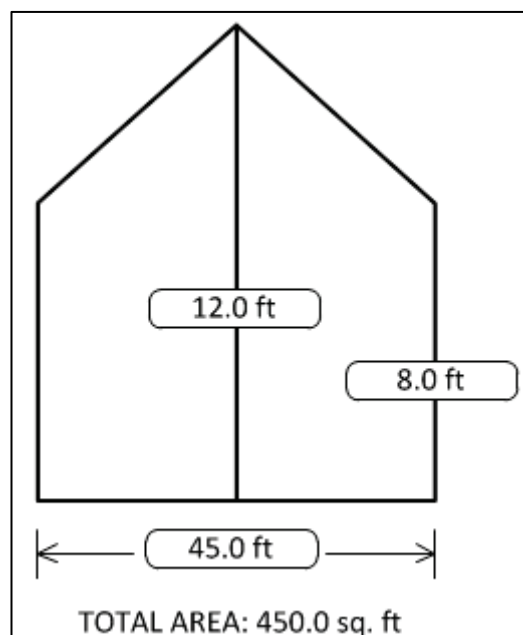

- Define height, width, and length of house (controller calculates total area).
- To set the dimensions in metric or non-metric units, go to *Installation > Setup* and scroll down to Length Unit.

NOTE: This information enables the calculation of the Wind Chill factor displayed in Hot Screen Key = 2 (Tunnel mode ONLY).

10.10 Communication

This screen defines the communication parameters.

COMMUNICATION SETUP	
Baud Rate	9600
House Number	1
LIGHT DIMMER	
Channel — a	Light Dimmer 3
Channel — b	Light Dimmer 1
Channel — c	Light Dimmer 2
Channel — d	<None>

1. Define the communication setup:

- **Baud rate:** This parameter is a measure of the communication speed for local or remote communications to a PC. The default is 9600 represents a data rate of approximately 1000 characters per second. If the connection fails at this speed, try a lower speed.
- **House number:** Each controller on a network must have a unique number so Munters communication software can distinguish individual controllers. Note that these numbers are from 1 to 64.

2. Define the Light Dimmer channels. Use this screen to map Farm Light dimmer units to a communication card channel.

Farm Light Dimmers are connected to a Farm Premium Controller via a:

- communication card or
- analog output card

In the event that:

- there is no analog output card installed or
- there is a an analog output card but all outputs are defined for other devices

this screen maps the Farm Light Dimmers connected via a communication card.

NOTE: If the Farm Premium Controller has an analog output card, you can map multiple RLD units using an output card and a communication card. However, the Farm Premium software prevents users from mapping a *particular* FLD unit using both methods. For example, if in Installation > Analog Output, you define one output as a light dimmer, Farm Premium does not allow mapping a channel to that light dimmer.

- ➔ A light dimmer and Farm Premium Extension unit can not share the same communication card interface. Connect the communication card to one hardware type only.

1 1 Appendix A: Output Data

Table 1: Sensor Readings

Sensor	Definition
Temp	Displayed with the specific sensor number
Out T.	Outside temperature
Press.	Pressure
Hum. In	Inside humidity
Hum. Out	Outside humidity
Weight	Average weight
Weights	Number of weights
E. Tmp1	Temperature related to emergency card 1
E. Tmp2	Temperature related to emergency card 2
Breaker	Circuit breaker

Table 2: Output List (Active)

Output	Definition
Alarm	Can be either active or not. Note that this always appears last.
Heat	Indicates operating heat number
Heat. Hi	Indicates operating heat high number
Tun. Fan	Indicates operating tunnel fan number
Exh. Fan	Indicates operating exhaust fan number
Stir	Indicates operating stir fan number
Cool P.	Indicates operating cool pad number
Fogger	Indicates operating fogger number
Inlet	
Tunnel	
Curt.	Mentions opening percentage
Ext. Sys	Indicates operating external system number
Light	Note that these mention output percentage
Water	Indicates operating water number
Feed	Indicates operating feed number

Output	Definition
Auger	Indicates operating auger number
Rad. Lo	Indicates operating radiant heat low number
Rad. Hi	Indicates operating radiant heat high number

Table 3: Status Readings

Status	Definition
Time	Specific time
Day	Growth day
Set	Target temperature
Offset	Temperature Curve HELP SET parameter
House mode	Control Mode HELP SET parameter
Level	Level number
Tunnel, Natural, Min. Vent	The controller's state
Fan Off	How long the cycle ends its' operation
Fan On	How long the cycle begins its' operation
Curve off	Occurs when located in low curve temperature or when the Control Mode HELP SET 'Temperature Curve' parameter is set to OFF.
Hum. Treat	Indicates when treatment occurs
Cool flush	Indicates when flush occurs
Nip. Flush	Indicates when flush occurs

Table 4: Table of Events

Event	Event Explanation
Power Off	Appears when power is off
Power On	Appears when power is on
Cold Start	Appears when cold start is done
Change level to vent	Changes according to a specific stage
Backup set reminder	HELP SET: 'Set Temp. Change remainder (diff)' parameter
Alarm on	Appears when the alarm is on
Change in setting	
Change in switches	Relay switch setting changed
New flock	Appears when new flock is updated
Reset alarm	Appears when reset alarm is done
System message #	For Munters' technicians only

Event	Event Explanation
Alarm card fail	Appears when the alarm card fails
Digital card fail	Appears when the digital card fails
Memory restore	Appears when the system does restore cause by noises
Minimum ventilation	Appears when minimum ventilation occurs
Natural ventilation	Appears when entering natural ventilation
Tunnel ventilation	Appears when entering tunnel ventilation
Alarm test	Appears when alarm test completes
Precision Mode	Switch to Precision Mode
Standard Mode	Switch to Standard Mode
Changed growth day	Appears when changing the growth day occurs
MinV L.P Alarm Dis.	Appears when minimum low pressure alarm is disabled
MinV L.P Alarm Ena	Appears when minimum low pressure alarm is enabled
Tun. L.P Alarm Dis.	Appears when tunnel low pressure alarm is disabled
Tun L.P Alarm Ena.	Appears when tunnel low pressure alarm is enabled
Visitor Log in	Appears when the visitor logs in with his password
User #1-5 log in	Appears when the user logs in with his password
Owner log in	Appears when the owner logs in with his password
Change Visitor pass	Appears when the visitor changed his password.
Change User #1-5 pass	Appears when the user changed his password
Change Owner pass	Appears when the owner changed his password
Data read from plug	Appears when data is read from plug
System recover	Appears when the system tries to recover itself, in cases such as noises
System lock	Appears when either using the correct password, or when using hot key '9,' or automatically after 5 minutes
Empty house mode	Appears when setting at a specific time

12 Appendix B: Farm Premium Layers

This section details functions specific to the Farm Premium Layers mode.

- Layers Main Screen
- Layers Vent and Curtain Levels

NOTE: Layers Mode supports 20 water meters.

12.1 Layers Main Screen

SENSORS		AV. TEMP.	ACTIVE	
Temp1	37.9°	27.5°	Heat	1
Temp2	16.2°	STATUS 08:53:06 Day: 5 Set: 25.0 Level: 3 Min. Vent FanOff: 176	Heat. Hi	1
Temp3	28.2°		Tun. Fan	
E. Tmp1	28.8°		Exh. Fan	
E. Tmp2	28.4°		Stir	
Press.	23		Cool P.	
Out T.	23.9°		Fogger	
Hum. In	58.7%		Inlet 1	55%
Hum. Out	61.9%		Inlet 2	55%
Weight	0.000		Inlet 3	50%
Weights	0		Tun. 1	0%
4 MESSAGES			Alarm	0%
(2) Low Feed At Silo 2				

Figure 21: Layers Main Screen

ACTIVE	
Heat	1
Heat. Hi	1
Tun. Fan	
Exh. Fan	
Stir	
Cool P.	
Fogger	
Inlet 1	55%
Inlet 2	55%
Inlet 3	50%
Tun 1	0%
Attic	0%

Figure 22: Layers Mode Active Sensors

12.2 Layers Vent and Curtain Levels

DEVICE SETTING	
1.	LEVELS OF VENTILATION
2.	SPEED FAN LEVELS
3.	VENT & CURTAIN LEVELS
4.	STIR FAN LEVELS
5.	STIR FAN PROGRAM
6.	COOL PAD
7.	FOGGERS
8.	LIGHT
9.	WATER & FEED
10.	EXTRA SYSTEMS
11.	EMERGENCY SETTING
12.	WATER ON DEMAND
13.	NATURAL PROGRAM

Set the curtain levels to correspond with the ventilation levels.

1. In *Install > Relay Outlet* (page 107), define at least one relay as a Curtain Open, Tunnel Open, Vent Open, or Inlet Open.
2. In *Control > Temperature curve*, define the Target Temperature.
3. In *Install > Setup*, enable Natural Ventilation (page 106).
4. In *Device Setting > Vent & Curtain Levels*, define the fans' working percentages.
5. Set the Help Set parameters as required.

VENT & CURTAIN LEVELS		
Level	Attic	Tunnel
1	45	45
2	45	45
3	40	40
4	40	40
5	45	45
6	45	45
7	45	45
8	45	45
9	45	45
10	40	40

- **Ventilation Level:** Read-only.
- **Tunnel/Curtain/Vent:** Set position for the tunnel curtain by level. If you have Static Pressure in Tunnel turned on (*Control | Static Pressure | Help | Set*), this becomes the minimum position for the tunnel inlet.

NOTE: Refer to *Vent & Curtain Levels Help | Set Definitions for Help Set details*.

12.2.1 LAYER INLET CONTROL

Inlets can be controlled via two methods:

- **Pressure:** In this mode, inlets open and close according to the static pressure.
- **Position:** In this mode, inlets open and close according to the temperature.

To select the inlet control method:

1. Go to *Device > Vent & Curtain Levels > Help*.
2. Scroll down to Zone Inlet and select **Press** or **Pos**.

12.2.1.1 Pressure Control

When set to Pressure control, the inlets work similarly to vents; namely, the inlets open and close according to the static pressure. Each inlet is independent; no inlet controls another inlet. The number shown is the opening percentage.

VENT & CURTAIN LEVELS	
Level	Inlet Avg
1	45
2	45
3	40
4	40
5	45
6	45
7	45
8	45
9	45
10	40

- **Level:** Read-only
- **Inlet Average:** Opening percentage

NOTE: The remaining Help > Set parameters are not relevant when using Pressure control.

To set pressure control:

1. At each level, place the cursor and type the inlet average level.
2. Press **Enter**.
3. Go to *Install > Curtain Setup* (page 111) and set the opening and closing times.

12.2.1.2 Position Control

When set to Position control, the inlets open and close according to the temperature. As the actual temperature differs from the target temperature, the inlet opens or closes. The number shown is the opening percentage.

VENT & CURTAIN LEVELS				
Level	Inlet Avg	Inlet 1	Inlet 2	Inlet 3
1	50	45	40	45
2	40	35	30	35
3	0	0	0	0
4	0	0	0	0
5	0	0	0	0
6	0	0	0	0
7	0	0	0	0
8	0	0	0	0
9	0	0	0	0
10	0	0	0	0

- **Level:** Read-only.
- **Inlet Average:** Set the opening position for **all** inlets by level.
- **Inlet 1/2/3 - 12:** Set the opening level for an **individual** inlet by level. Set up to 12 inlets.

NOTE: When setting individual inlet openings, configure each inlet to work with a particular temperature sensor. Refer to page 114.

To set position control:

1. At each level, place the cursor and type the opening level.
2. Press **Enter**.
 - Whichever parameter, the Inlet Avg or Inlet 1/2/3, is set **last** determines the opening level. For example, if you enter parameters for Inlet 1/2/3, and then enter the Inlet Avg parameter, this number overrides the Inlet 1/2/3 parameters.
 - Entering "0" disables the parameter.

12.2.2 LAYER VENT & CURTAIN (INLET) LEVELS HELP | SET DEFINITIONS

SYSTEM PARAMETERS	
ATTIC	
Minimum Attic Temp. To Operate	85
Operate Until Day	10
Operate Until Level	10
Operate From Time	0:00
Operate To Time	0:00
Max Temperature to Disable Attic	100.0
ZONE INLET	
Operation by Pressure/Position	POS.
Compensation % Per Degree	3
Delay for Compensation (min)	5
Maximum Compensation Opening	10
Temp. Compensation Hysteresis	0.5
Num. Steps For Inlet to Calib.	5

Zone Inlet

- **Operation by Pressure/Position:** Sets the inlet opening mode, by Pressure or Position.

NOTE: Configure the Compensation Percentage, Delay, Maximum Compensation and Temperature Compensation only when using Operation by Position.

- **Compensation % Per Degree:** For each degree that the actual temperature differs from the Target Temperature, the inlets:
 - open by this percentage (if the actual temperature is above the target temperature)
 - close by this percentage (if the actual temperature is below the target temperature)

For example, if the actual temperature is 2° above the target temperature, the inlet opens an additional 6%. Default: 1 %/°F
- **Delay for Compensation (minutes):** As the temperature sensors record changes in temperature, Farm Premium waits this amount of time before changing the inlet position. Default: 5 minutes
- **Maximum Compensation Opening:** Inlet opening does not differentiate from the set level more than this amount, regardless of the temperature. Default: 10%
- **Temperature Compensation Hysteresis:** Temperature band defining when compensation begins. Default: ±0.5° F

For example, if the Target Temperature is 80° and the Temperature Compensation Hysteresis is 1°, compensation begins above 81° or below 79°.
- **Number Steps For Inlet to Calibrate:** Set calibration point for inlet after desired amount of curtain opening/closing (steps). During calibration, if the curtain is open more than 50% it

opens to 100%, calibrates, and returns to the previous position. If the curtain is open less than 50% it closes to 0%, calibrates, and returns to the previous position. Default: 99.

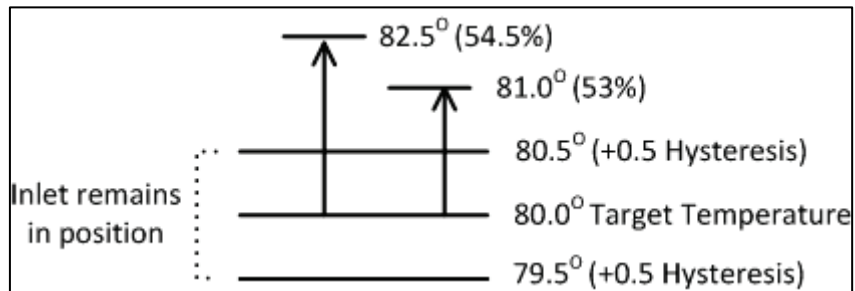

Figure 23: Example of Inlet Opening Hysteresis

Figure 25 illustrates an example of inlet hysteresis. An inlet is set to open to 50%, with a compensation of 3% for each degree. The target temperature is 80.0°, with a hysteresis of 0.5°. Between 79.5° to 80.5°, the inlet remains at 50%. If the temperature rises to 81.0°, the opening goes to 53%.

12.3 Layer Dimmers

Layer mode supports up to ten analog dimmer channels.

ANALOG OUTPUT				
Out Num	Function	Num	Min V. Out	Max V. Out
1	Light Dimmer	1	0.0	10.0
2	Light Dimmer	2	0.0	10.0
3	Light Dimmer	3	0.0	10.0
4	Light Dimmer	4	1.0	9.0
5	Light Dimmer	5	1.0	9.0
6	Light Dimmer	6	1.0	9.0
7	Light Dimmer	7	1.0	9.0
8	Light Dimmer	8	0.0	10.0
9	Light Dimmer	9	0.0	10.0
10	Light Dimmer	10	0.0	10.0

13 Appendix C: Farm Premium Breeders

- Egg Room Setup
- Egg Room Water and Feed
- Egg Belt Runtime
- Egg Room Hot Screen
- Egg Room History

13.1 Egg Room Setup

The following procedures details the steps required to set up the Egg Room functions.

1. In *Install > Relay Layout*, define five relays as:

- Egg room heater
- Egg room fan 1
- Egg room fan 2
- Egg Room Cool
- Humidifier

RELAY LAYOUT			
Relay	Function	Num	NO/NC
1	Hum. Egg Room Sensor	1	—
2	Egg Room Cooling	1	—
3	Egg Room Heater	1	—
4	Egg Room Fan	2	—
5	< None >	1	—
6	< None >	2	—
7	< None >	1	—
8	< None >	1	—
10	< None >	9	< None >
N.O. Relay			

NOTE: Refer to *Relay Layout*, page 107, for details on this screen.

2. In *Install > Analog Sensors*, set the input functions as Temperature Sensors and as an Egg Room Humidity sensor

NOTE: Refer to *Analog Sensors*, page 109 for details on this screen.

3. In *Install > Temperature Definition*, configure which temperature sensors operate in the egg room.

TEMPERATURE DEFINITION	
Function	Temp. Sensor
	1 2 3 4 5 6 7 8 9
Full House	√√√
Tunnel setting
Attic	. . . √ . . .
Outside √ . .
Egg Room √ . .
Work Room √ . .
Feed Area √ . .

NOTE: Refer to *Temperature Definition*, page 114 for details on this screen.

4. In *Service > Humidity Calibration*, calibrate the Egg Room humidity sensor.

HUMIDITY CALIBRATION		
Sensor	Humidity°	Factor
In-1	58.9	2.3
In-2	58.9	2.3
Out	N/A	---
Egg Room	67	2.0

Press Left/Right Arrows to Calibrate

NOTE: After defining egg room temperature sensors, the egg room temperature appears on the main screen.

SENSORS	
Temp1	37.9°
Temp2	16.2°
Temp3	28.2°
E. Tmp1	28.8°
E. Tmp2	28.4°
Egg Room	28.4

NOTE: Refer to Humidity Calibration, page 71 for details on this screen.

5. In Control > Egg Room, set the following on/off parameters:

- Heater temperature
- Fan 1 temperature
- Fan 2 temperature
- Cooling temperature
- Humidifier relative humidity percentage

EGG ROOM CONTROL		
Function	On	Off
Heater Temp	62.0	66.0
Fan 1 Temp	70.0	66.0
Fan 2 Temp	70.0	66.0
Cooling Temp	74.0	70.0
Humidifier %rh	65	70

6. In Control > Egg Room > Help > Set, configure the following alarm parameters:

- Low Temperature
- High Temperature
- Low Humidity
- High Humidity
- Delay (minutes)

EGG ROOM	
ALARM	
Low Temp	62.6
High Temp	71.6
Low Humidity	70
High Humidity	80
Delay (minute)	60

The Breeder Mode is configured.

13.2 Egg Room Water and Feed

In Breeder Mode, the water and feed schedule is independent of the growth day. In addition, Breeder Mode enables lowering the target temperature during the feeding time. When birds begin to feed, they congregate near the feeders and the temperature rises (which negatively affects the birds' feed intake). To compensate, increase the ventilation before/during the feeding time by lowering the target

1. Go to Device > Water & Feed.

WATER & FEED								
Time	From	To	Water		Feeder		Auger	
			1	2	1	2	1	2
4:00	4:00	4:30	●	■	●	■	●	■
4:45	4:45	5:15	●	■	●	■	●	■
5:00	5:00	5:30	●	◐	■	◐	●	◐
7:00	7:00	8:00						
0:00	0:00	0:00						
0:00	0:00	0:00						
0:00	0:00	0:00						
0:00	0:00	0:00						
0:00	0:00	0:00						

2. Set the parameters as required:
 - **Time:** Set event times for water, feeder, or auger.
 - Set the water, feeder, and auger lines to Continuous, Cycle, or Off.
3. Go to Device > Water & Feed > Help (optional).

WATER & FEED	
TEMP TARGET ADJUST	
Change Target From:	4:45
Change Target To:	8:00
Temp Target Offset:	-5.0
FEED LINE OPERATION	
Line 1 Down (hh:mm)	4:45
Line 1 Up (hh:mm)	5:00
Line 2 Down (hh:mm)	4:45
Line 2 Up (hh:mm)	5:00
WATER CYCLE TIME	
Cycle On	30
Cycle Off	270
FEEDER CYCLE TIME	
Cycle On	60
Cycle Off	200
AUGER CYCLE TIME	
Cycle On	50
Cycle Off	50

4. If a device is set to Cycle, define the Water/Feeder/Auger On and Off times.

5. To adjust the target temperature during feeding (to increase ventilation):
 - a. Define the To/From times.
 - b. Define the Target Temperature Offset (to reduce the target).

NOTE: To disable this feature set the offset to 0.

6. To control the male breeders feeding time:
 - a. Under Feed Line Operation, define when the lines descend and rise (Line Down, Line Up times).
 - b. Go to *Service > Feed Line Calibration*.
 - c. Enter the amount of time required for the curtains to rise and descend.

NOTE: Measure these times if you don't know them.

FEED LINE CALIBRATION	
Function	Run Time (sec).
Feed Line 1 Up	60
Feed Line 1 Down	50
Feed Line 2 Up	80
Feed Line 2 Down	40

Additional points:

- In Breeder Mode, Farm Premium supports up to:
 - 10 feeders
 - Four water lines
 - Four augers
 - Define these functions in *Install > Relays*.
- To and From times can overlap. For example, in the table above one line goes from 4:45 to 5:15 and the next line goes from 5:00 to 5:30. If there is overlap and contradictory configurations, the priority is Continuous > Cycle > Off. In the example above:
 - Water Line 2 will run in a cycle from 5:00 until 5:30.
 - Feeder Line 1 will be on 4:45 until 5:15, even though the line 3 turns off the feeder.

13.3 Egg Belt Runtime

Farm Premium Breeder supports measuring the egg belt runtime.

➤ Install digital input cards.

1. Go to *Install > Digital Sensors*.

DIGITAL SENSORS		
In	Function	Num
1	Water Meter	1
2	Auger – 1 Overtime	1
3	Cool Pad Water Meter	1
4	Fogger Water Meter	1
5	Water Meter	2
6	Feeder Over Time	1
7	Egg Belt	1
8	< None >	0

2. Define a sensor as Egg Belt.

3. Go to History > Egg Belt Run Time to view the data.

13.4 Egg Room Hot Screen

The Breeder Mode supports the following additional Hot Screen:



Egg Room Status. This screen displays the current temperature, relative humidity, and readings from the five relays.

13.5 Egg Room History

- Go to *History > Egg Room* to view a daily history of the egg room temperature and humidity. Press the right/left arrow keys to switch between views.

EGG ROOM			
Day	TEMPERATURE		
	Minimum	Average	Maximum
1	76	79	80

EGG ROOM			
Day	HUMIDITY		
	Minimum	Average	Maximum
1	62	65	69

13.6 Nest Function

The Nest function enables opening and closing (up to) four Nest lines at specific times. Birds can then leave their Nests and return.

Nests				
Num	Open	Duration	Close	Duration
	Time		Time	
1	0:00	0	0:00	0
2	0:00	0	0:00	0
3	0:00	0	0:00	0
4	0:00	0	0:00	0

1. In *Installation > Relay Layout* designate up to four relays (each) as Nest Open and Nest Close valves.

2. In *Device > Nest*, define the parameters:

- **Open Time:** The time each Nest lines' doors open.
- **Duration:** The amount of time required for the Nests to open.
- **Close Time:** The time each Nest lines' doors close.
- **Duration:** The amount of time required for the Nests to close.

13.7 Work Room Control

This screen enables controlling the temperature in the work room.

WORK ROOM CONTROL		
Function	On	Off
Heater 1 (Temp)	16.7	18.9
Heater 2 (Temp)	16.7	18.9
Fan 1 (Temp)	21.1	18.9
Fan 2 (Temp)	21.1	18.9

1. In *Control > Work Room*, set the following on/off parameters:

- Heater 1 and 2 temperature
- Fan 1 temperature
- Fan 2 temperature

2. In *Install > Temperature Definition*, define 1 or 2 sensors as Work Room temperature sensors (refer to Temperature Definition, page 110 for details on this function)

TEMPERATURE DEFINITION	
Function	Temp. Sensor
	1 2 3 4 5 6 7 8 9
Full House	√√√
Tunnel setting
Attic	. . . √ . . .
Outside √ . .
Egg Room √ . .
Work Room √ . .
Feed Area √ . .

13.8 Scale Arm

During feed distribution, each silo has a mechanical arm that disconnects at the end of a feed cycle, preventing further distribution. When this disconnect happens, a signal is sent from the arm to the silo, informing the latter that it must be refilled. Farm Premium enables recording these signals in the Events History.

To define the Scale Arm:

1. Go to *Install > Digital Sensors*.
2. Define one sensor as Scale Arm.

DIGITAL SENSORS		
In	Function	Num
1	Scale Arm	1
2	< None >	0
3	< None >	0
4	< None >	1
5	< None >	0
6	< None >	0
7	< None >	0
8	< None >	0

- In *History > Table of Events*, Feed Delivered appears when the mechanical arm disconnects.

TABLE OF EVENTS			
	Event	Day	Time
1	Feed Delivered	1	13:27:05

14 Warranty

Warranty and technical assistance

Munters products are designed and built to provide reliable and satisfactory performance but cannot be guaranteed free of faults; although they are reliable products they can develop unforeseeable defects and the user must take this into account and arrange adequate emergency or alarm systems if failure to operate could cause damage to the articles for which the Munters plant was required: if this is not done, the user is fully responsible for the damage which they could suffer.

Munters extends this limited warranty to the first purchaser and guarantees its products to be free from defects originating in manufacture or materials for one year from the date of delivery, provided that suitable transport, storage, installation and maintenance terms are complied with. The warranty does not apply if the products have been repaired without express authorization from Munters, or repaired in such a way that, in Munters' judgment, their performance and reliability have been impaired, or incorrectly installed, or subjected to improper use. The user accepts total responsibility for incorrect use of the products.

The warranty on products from outside suppliers fitted to Farm Premium, (for example sensors, analog inputs, cables, etc.) is limited to the conditions stated by the supplier: all claims must be made in writing within eight days of the discovery of the defect and within 12 months of the delivery of the defective product. Munters has thirty days from the date of receipt in which to take action, and has the right to examine the product at the customer's premises or at its own plant (carriage cost to be borne by the customer).

Munters at its sole discretion has the option of replacing or repairing, free of charge, products which it considers defective, and will arrange for their dispatch back to the customer carriage paid. In the case of faulty parts of small commercial value which are widely available (such as bolts, etc.) for urgent dispatch, where the cost of carriage would exceed the value of the parts, Munters may authorize the customer exclusively to purchase the replacement parts locally; Munters will reimburse the value of the product at its cost price.

Munters will not be liable for costs incurred in demounting the defective part, or the time required to travel to site and the associated travel costs. No agent, employee or dealer is authorized to give any further guarantees or to accept any other liability on Munters' behalf in connection with other Munters products, except in writing with the signature of one of the Company's Managers.

WARNING! *In the interests of improving the quality of its products and services, Munters reserves the right at any time and without prior notice to alter the specifications in this manual.*

The liability of the manufacturer Munters ceases in the event of:

- dismantling the safety devices;
- use of unauthorized materials;

- inadequate maintenance;
- use of non-original spare parts and accessories.

Barring specific contractual terms, the following are directly at the user's expense:

- preparing installation sites;
- providing an electricity supply (including the protective equipotential bonding (PE) conductor, in accordance with CEI EN 60204-1, paragraph 8.2), for correctly connecting the equipment to the mains electricity supply;
- providing ancillary services appropriate to the requirements of the plant on the basis of the information supplied with regard to installation;
- tools and consumables required for fitting and installation;
- lubricants necessary for commissioning and maintenance.

It is mandatory to purchase and use only original spare parts or those recommended by the manufacturer.

Dismantling and assembly must be performed by qualified technicians and according to the manufacturer's instructions.

The use of non-original spare parts or incorrect assembly exonerates the manufacturer from all liability.

Requests for technical assistance and spare parts can be made directly to the nearest Munters office. A full list of contact details can be found on the back page of this manual.



www.munters.com

Australia Munters Pty Limited, Phone +61 2 8843 1594, **Brazil** Munters Brasil Industria e Comercio Ltda, Phone +55 41 3317 5050, **Canada** Munters Corporation Lansing, Phone +1 517 676 7070, **China** Munters Air Treatment Equipment (Beijing) Co. Ltd, Phone +86 10 80 418 000, **Denmark** Munters A/S, Phone +45 9862 3311, **India** Munters India, Phone +91 20 3052 2520, **Indonesia** Munters, Phone +62 818 739 235, **Italy** Munters Italy S.p.A., Chiusavecchia, Phone +39 0183 52 11, **Japan** Munters K.K., Phone +81 3 5970 0021, **Korea** Munters Korea Co. Ltd., Phone +82 2 761 8701, **Mexico** Munters Mexico, Phone +52 818 262 54 00,, **Singapore** Munters Pte Ltd., Phone +65 744 6828, **South Africa and Sub-Sahara Countries** Munters (Pty) Ltd., Phone +27 11 997 2000, **Spain** Munters Spain S.A., Phone +34 91 640 09 02, **Sweden** Munters AB, Phone +46 8 626 63 00, **Thailand** Munters Co. Ltd., Phone +66 2 642 2670, **Turkey** Munters Form Endüstri Sistemleri A.Ş, Phone +90 262 751 37 50, **USA** Munters Corporation Lansing, Phone +1 517 676 7070, **Vietnam** Munters Vietnam, Phone +84 8 3825 6838, **Export & Other countries** Munters Italy S.p.A., Chiusavecchia Phone +39 0183 52 11