

Installation Manual

Platinum
Pro/Platinum
Touch/One/
One Pro



Platinum Pro/Platinum Touch/ One/One Pro

Climate Controllers

Ag/MIS/IGB-2282-09/15 Rev. 2.0

P/N: 117472



Platinum Pro/Platinum Touch/ One/One Pro Installation Manual

Revision: N2.0 of 07/2023

Product Software: Version 6.20/7.20

This manual for use and maintenance is an integral part of the apparatus together with the attached technical documentation.

This document is destined for the user of the apparatus; it may not be reproduced in whole or in part, committed to computer memory as a file or delivered to third parties without the prior authorization of the assembler of the system.

Munters reserves the right to effect modifications to the apparatus in accordance with technical and legal developments.

Index

<i>Chapter</i>		<i>page</i>
1	INTRODUCTION.....	6
1.1	Disclaimer.....	6
1.2	Introduction	6
1.3	Notes	6
2	PRECAUTIONS.....	7
2.1	English.....	7
2.1.1	Grounding	7
2.1.2	Filtering.....	7
2.1.3	Checking the Battery Level.....	7
2.1.4	Frequency Inverters.....	7
2.2	French.....	8
2.2.1	Raccord à la Terre	8
2.2.2	Filtrage	8
2.2.3	Vérification du Niveau de la Batterie	9
2.2.4	Onduleurs de Fréquence.....	9
3	SPECIFICATIONS.....	10
4	BEFORE USING	12
4.1	Layout.....	12
4.1.1	Number of Relays	12
4.1.2	Platinum Pro Layout.....	13
4.1.3	One Pro Layout.....	14
4.2	Typical Accessories.....	15
4.3	Product Symbols	16
5	MOUNTING THE UNITS.....	17
5.1	Installing the Platinum Pro	17
5.1.1	Mounting the Platinum Pro.....	17
5.1.2	Drilling.....	17
5.2	One Pro	19
5.2.1	What comes in the Package.....	19
5.2.2	Knockouts.....	20
5.2.3	Mounting	20
6	HIGH VOLTAGE WIRING.....	22
6.1	Power Supply.....	22

6.2	RPLP Wiring.....	22
6.3	Relay Wiring.....	23
6.3.1	Platinum Pro Relay Wiring.....	24
6.3.2	One Pro Relay Wiring.....	25
6.3.3	Final Steps.....	26
6.4	Winch Card Relay Wiring.....	26
6.4.1	Platinum Pro Winch Card Relay Wiring.....	26
6.4.2	One Pro Winch Card Relay Wiring	27
6.5	Completing the Wiring.....	28
7	LOW VOLTAGE WIRING	29
7.1	Analog Input Wiring.....	29
7.1.1	Analog Card DIP Switches.....	30
7.1.2	Analog Input Wiring Diagram for Temperature Sensors	30
7.1.3	Analog Input Wiring Diagram for CO2 and Light Sensor	32
7.1.4	Analog Input Wiring Diagram for Potentiometers	33
7.1.5	Analog Input Wiring Diagram for Humidity Sensors.....	33
7.1.6	Analog Input Wiring Diagram for Ammonia Sensors.....	34
7.2	Weather Station Wiring	35
7.3	Digital Input Wiring.....	37
7.4	Analog Output Wiring	38
7.5	Alarm Card Wiring	39
7.6	Communication Card Wiring	40
7.7	RS-485 Termination.....	41
7.7.1	Controllers and Comm-Box.....	41
7.7.2	Controllers and Communicator.....	42
7.7.3	Controller, Relay Expansion, RSU-2 and HUB	42
7.7.4	Placing the Terminator	44
8	SCALE CARD WIRING	46
8.1	Bird Scale Wiring	46
8.2	Feed Scale Wiring.....	Error! Bookmark not defined.
8.3	Silo Scale Wiring.....	Error! Bookmark not defined.
9	APPENDIX A: PLATINUM PRO METAL ASSEMBLY.....	49
9.1	Metal Assembly Precautions	49
9.2	Panels.....	50
9.3	Panel Dimensions	51
9.4	Mounting the Panels	55
9.5	Connecting the Metal Panels	56
9.5.1	Precautions	57
9.5.2	Panel Mount Cable Connections.....	58
10	APPENDIX B: ONE PRO WINCH CARD SET REPLACEMENT	63

10.1	General.....	63
10.2	In Practice.....	64
10.3	Relay Card Layout Considerations	65
11	APPENDIX C: ELECTRICAL GROUNDING	66
11.1	Ground Rods	66
11.2	Ground Wire.....	66
11.3	Ground Clamps.....	67
11.4	What Should Be Grounded?.....	67
11.5	Lightening Protection	67
11.5.1	Power Line Protection.....	67
11.5.2	Communication Line Protection.....	67
12	APPENDIX D: ELECTROMAGNETIC NOISE SUPPRESSION CIRCUIT	68
12.1	English.....	68
12.2	Circuit de Suppression de Bruit Electromagnetique.....	68
13	WARRANTY	70

1 Introduction

- Disclaimer
- Introduction
- Notes

1.1 Disclaimer

Munters reserves the right to make alterations to specifications, quantities, dimensions etc. for production or other reasons, subsequent to publication. The information contained herein has been prepared by qualified experts within Munters. While we believe the information is accurate and complete, we make no warranty or representation for any particular purposes. The information is offered in good faith and with the understanding that any use of the units or accessories in breach of the directions and warnings in this document is at the sole discretion and risk of the user.

1.2 Introduction

Congratulations on your excellent choice of purchasing a Platinum Pro, Platinum Touch, One, or One Pro!

In order to realize the full benefit from this product it is important that it is installed, commissioned and operated correctly. Before installation or using the controller, this manual should be studied carefully. It is also recommended that it is kept safely for future reference. The manual is intended as a reference for installation, commissioning and day-to-day operation of the Munters Controllers.

1.3 Notes

Date of release: May 2009

Munters cannot guarantee to inform users about the changes or to distribute new manuals to them.

All rights reserved. No part of this manual may be reproduced in any manner whatsoever without the expressed written permission of Munters. The contents of this manual are subject to change without notice.

2 Precautions

CAUTION Protection provided by the equipment can be impaired if the equipment is used in a manner not specified by the manufacturer!

CAUTION There is a risk of explosion if the lithium battery is replaced with an incorrect type. Replace the battery using the same type and manufacturer only.

- English
- French

2.1 English

- Grounding
- Filtering
- Checking the Battery Level
- Frequency Inverters

2.1.1 GROUNDING

- Always connect temperature and sensor shields to earth ground. Avoid mixing high voltage wiring with sensor and low voltage wiring.
- Keep the controller as far as possible from heavy contactor boxes and other sources of electrical interference.
- Do not connect communication wire shields, which go from one house to another at both ends. Connect them at one end only. Connection at both ends can cause ground loop currents to flow, which reduce reliability.
- The COM connection for communications is not the shield wire. The COM, RX and TX wires must connect to each other at all controllers.

2.1.2 FILTERING

If this installation includes a power inverter to drive variable speed fans, install an EMI filter in front of the inverter, according to the specifications provided by the inverter manufacturer. Refer to the inverter documentation.

2.1.3 CHECKING THE BATTERY LEVEL

Check the battery once a year. The output must be 2.7 volts (minimum). Authorized personnel only must replace the battery if the output is below the minimum required level or every five years.

2.1.4 FREQUENCY INVERTERS

Frequency inverters can cause severe electrical and electromagnetic interference. Therefore, when employing a frequency inverter, it is critical that you carefully follow the manufacturer's installation instructions.

In particular verify:

- That the cable shielding between the inverter and any motor meets industry standards
- Proper grounding of the inverter's chassis and motor power cable
- Proper grounding of low voltage cable shield wire
- That the controller and inverter cables are kept in separate conduits or wire bundles

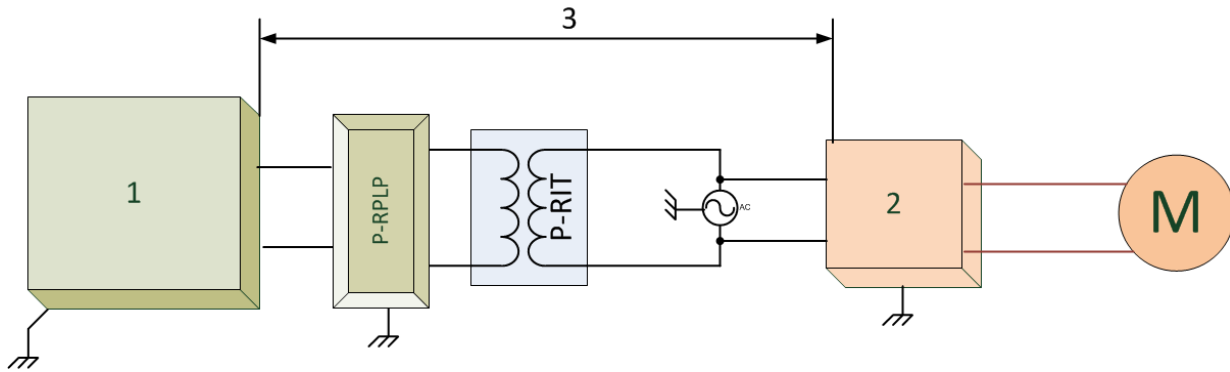

1. Controller
2. Inverter
3. Place the controller at least five meters from the inverter

2.2 French

- Raccord à la Terre
- Filtrage
- Vérification du Niveau de la Batterie
- Onduleurs de Fréquence

2.2.1 RACCORD À LA TERRE

- Raccordez toujours à la terre les protections thermiques et du capteur. Evitez de mélanger les fils à haute tension avec les fils du capteur et les fils à basse tension.
- Maintenez le contrôleur aussi loin que possible du boîtier lourd de contacteur et des autres sources d'interférences électriques.
- Ne connectez les protections des fils de communication, allant d'une maison à une autre aux deux extrémités. Connectez-les à une seule extrémité uniquement. La connexion aux deux extrémités peut entraîner la circulation de courants dans la boucle de terre, et risquer ainsi de réduire la fiabilité.
- La connexion COM pour les communications n'est pas le fil blindé. Les fils COM, RX et TX doivent être connectés les uns aux autres au niveau de tous les contrôleurs.

2.2.2 FILTRAGE

Si cette installation comprend un onduleur de puissance capable d'actionner les ventilateurs à vitesse variable, installez un filtre EMI en amont de l'onduleur selon les

spécifications fournies par le fabricant de l'onduleur. Référez-vous à la documentation de l'onduleur.

2.2.3 VÉRIFICATION DU NIVEAU DE LA BATTERIE

Vérifiez la batterie une fois par an. La sortie doit être 2.7 volts (minimum). Seul le personnel autorisé est en droit de remplacer la batterie si la sortie est inférieure au niveau minimum ou tous les cinq ans.

2.2.4 ONDULEURS DE FRÉQUENCE

Les onduleurs de fréquence peuvent causer de sévères interférences électriques et électromagnétiques. Par conséquent, lorsque vous utilisez un onduleur de fréquence, il est essentiel de suivre scrupuleusement les instructions du fabricant.



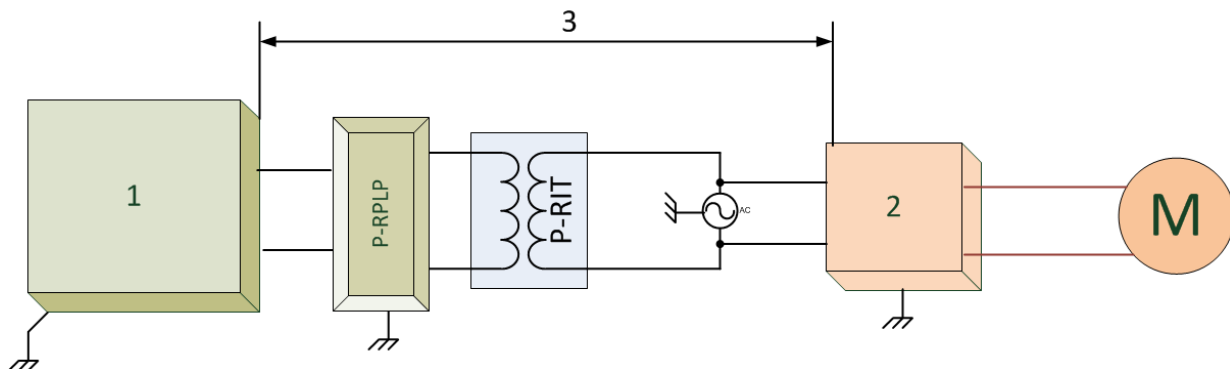

Vérifiez en particulier :

- Que la protection des câbles entre l'onduleur et le moteur réponde aux normes industrielles.
- Que le raccord à la terre pour le châssis de l'onduleur et le câble d'alimentation du moteur soit correct
- Que le raccord à la terre du fil de protection du câble à basse tension soit correct
- Que les câbles du contrôleur et de l'onduleur soient conservés dans des conduites séparées ou des faisceaux de fils



1. Manette
2. Onduleur
3. Placez le contrôleur à au moins 5 mètres de l'onduleur

3 Specifications

Description	Specification
Input Power Voltage	<ul style="list-style-type: none"> • 100 – 240 VAC • Platinum Touch: 1A, 50/60 Hz • Platinum Pro: 0.6A, 50/60 Hz • One: 1.2A, 50/60 Hz • One Pro: 0.8A, 50/60 Hz
Normally Open Relays	<ul style="list-style-type: none"> • Non Fused • 70% of relays can operate simultaneously (maximum) • 200 – 240 VAC max load: 2HP (7A during continual operation, up to 30A at startup) • 100 – 130 VAC max load: 1HP (7A during continual operation, up to 30A at startup)
Normally Close Relays	<ul style="list-style-type: none"> • Non Fused • 70% of relays can operate simultaneously (maximum) • 200 – 240 VAC max load: 1HP (4A during continual operation, up to 20 Amp at startup) • 100 – 130 VAC max load: 0.5HP (4A during continual operation, up to 20A at startup)
CAUTION Switching loads over 10A reduces a relay's life span (from 100,000 operations to ~10,000 operations).	
Analog Inputs	0 - 5 Volts, 5VDC maximum
Analog Output	0 - 10 Volts; maximum load: 20 mA
Digital Inputs	5 Volts, 1.5 mA, dry contact
Operating Temperature Range	0° to +50° C (32° to 125° F)
Enclosure	<ul style="list-style-type: none"> • Water and dust tight • indoor use only
Fuses	Fuse F1 on PS card: 5A, 250V
Certification	   

- **Disconnection device/overcurrent protection:** In the building installation, use a certified 2-pole circuit breaker rated 10A, certified in accordance with the IEC standard 60947-2 (in the US and Canada uses a Listed Branch Circuit protective circuit breaker). This step is required to provide overcurrent protection and mains disconnection. The circuit breaker must be easily accessible and marked as the controller disconnect device.
- **Main Supply Voltage:** Permanently connect the controller to the mains in accordance with the relevant national code. Provide fixed wiring inside a flexible

conduit. Relays must be suitably protected against overcurrent, using a circuit breaker rated at 10A.

4 Before Using

*NOTE Platinum Pro refers to the Platinum Pro and Platinum Touch units unless specified.
One Pro refers to the One and One Pro units unless specified.*

- Layout
- Typical Accessories
- Product Symbols

4.1 Layout

- Number of Relays
- Platinum Pro Layout
- One Pro Layout

4.1.1 NUMBER OF RELAYS

- Platinum Pro supports 30 relays
- One Pro supports 50 relays
- Panel Mounts support 30 or 50 relays

4.1.2 PLATINUM PRO LAYOUT

This illustration displays the main elements found in the Platinum Pro and Platinum Touch.

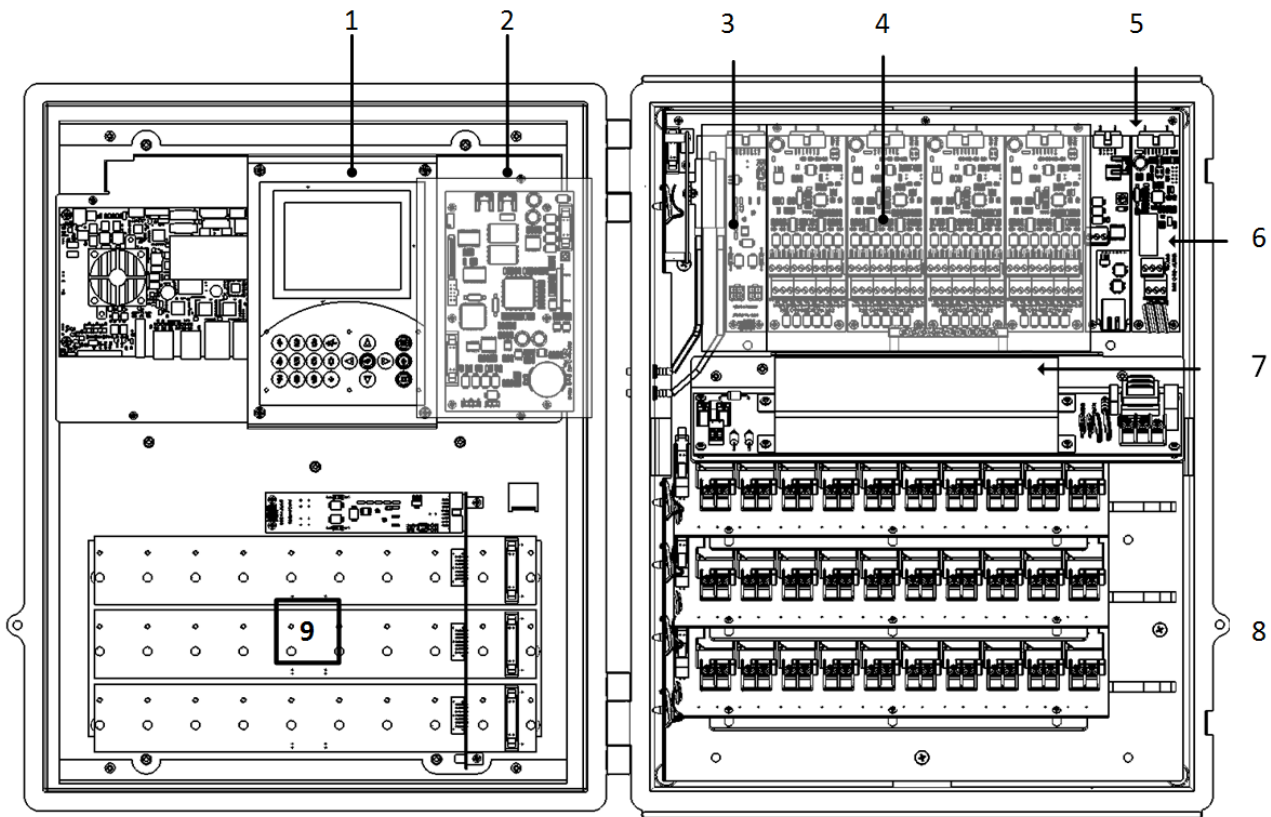

Figure 1: Platinum Pro Layout

Figure 1 key			
1	Backup screen and keyboard (Touch only)	6	Communication card
2	Main CPU card	7	Power supply
3	Communication card to Expansion unit/RLED 2.0	8	Normally Open, Normally Closed, Winch, Current Sense cards
4	Analog Input/Output and Digital Input cards	9	Switch cards
5	Alarm card		

4.1.3 ONE PRO LAYOUT

The following illustration displays the main elements in One Pro units.

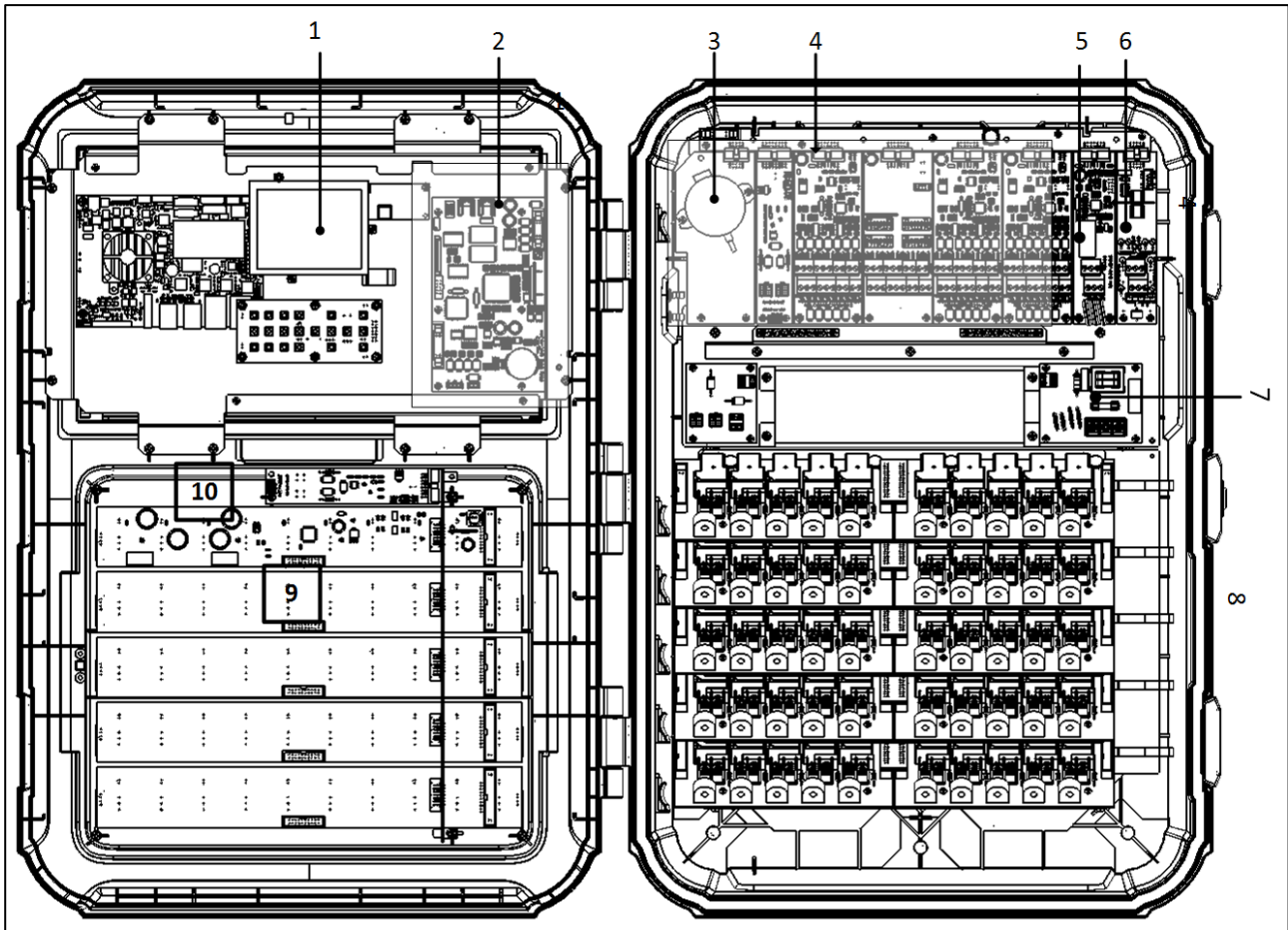

Figure 2: Pro / One Layout

Figure 2 key			
1	Backup screen and keyboard (Touch only)	6	Communication card
2	Main CPU card	7	Power supply, high voltage
3	Pressure sensor	8	Normally Open, Normally Closed, Winch, Current Sense cards
4	Analog Input/Output and Digital Input cards	9	Switch cards
5	Alarm card	10	Internal communication card

NOTE Figure 1 and Figure 2 are example layouts. Each installation can differ.

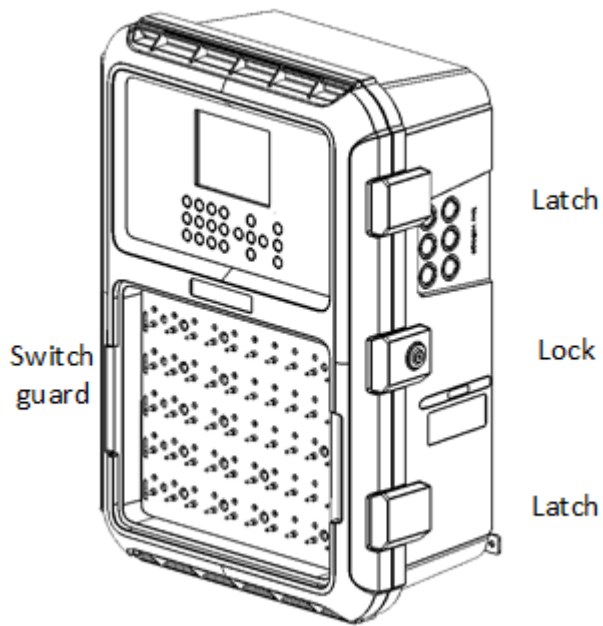

Figure 3: One Pro External Parts

4.2 Typical Accessories

Platinum Pro and One support:

- Analog input, digital input, analog output cards
- 1 x Platinum Pro Expansion unit
- 5 x [RLED 2.0](#)
- 1 X [RDT-5](#) (Software version X.20 supports two RDT-5 units)
- 2 x [RSU-2](#) (Software version X.18 supports five RSU-2 units)
- 1 x [HUB-4](#)

NOTE This manual provides wiring instructions for the cards. Refer to the products respective manuals for installation instructions.



<p>Figure 4: Expansion units</p>	<p>Figure 5: RLED 2.0</p>
 <p>A black Munters RDT-5 expansion unit with a blue top and bottom section. It features a digital display showing '4' and '800', several indicator lights, and control buttons.</p>	 <p>A black Munters RLED 2.0 expansion unit with a blue top and bottom section. It features a digital display showing '1300', indicator lights, and control buttons.</p>
<p>Figure 6: RDT-5</p>	<p>Figure 7: RSU-2</p>
 <p>A plain white Munters HUB expansion unit with a simple rectangular design and a latch on the left side.</p>	 <p>A collection of accessories for the RSU-2 unit, including a blue-handled CO2 sensor probe, a clear plastic sensor housing with a green PCB, and various cables.</p>
<p>Figure 8: HUB</p>	<p>Figure 9: Accessories</p>

4.3 Product Symbols

The following labels appear on your controller:



: Caution! Hazardous voltage



: Caution: Refer to the manual



: Main Protective Earthing Terminal

CAUTION IF THE UNIT IS USED IN A MANNER NOT SPECIFIED BY THE MANUFACTURER, THE PROTECTION PROVIDED BY THE EQUIPMENT MAY BE IMPAIRED.

5 Mounting the Units

The following sections detail the initial steps required when installing the controllers. Users installing the Panel Mounts, refer to Appendix A: Platinum Pro Metal Assembly

5.1 Installing the Platinum Pro

- Mounting the Platinum Pro
- Drilling

5.1.1 MOUNTING THE PLATINUM PRO

1. Remove the mounting plates (x4) and screws (x8) from the plastic bag.



2. Fasten the mounting plates to the corners of the controller using four screws.

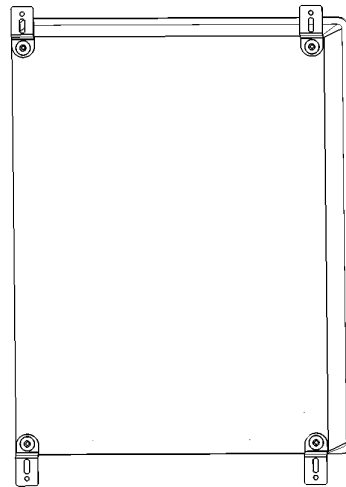

3. Place the controller box on the wall and make sure it is leveled (use a spirit level).

4. Using the remaining screws, secure the controller to the wall.

5.1.2 DRILLING

Drill holes on the side and bottom of controller box according to the steps defined below. Use these holes to route the low and high voltage cables.

CAUTION *Make sure not to damage cards when drilling holes. Locate holes properly before drilling!*

1. Drill a hole on the right side of the controller box. Verify that the low voltage cables being used go through the hole properly.

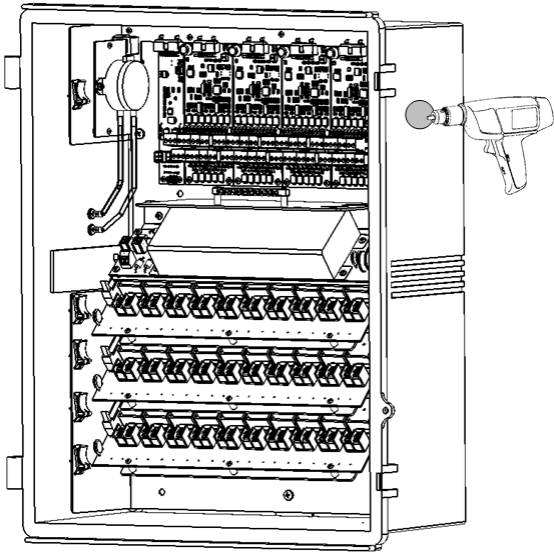

Figure 10: Drilling on the Side

2. Drill a hole on the bottom side of the controller box. Verify that the high voltage cables being used fit through the hole properly.

NOTE Munters recommends drilling at least two (2) holes, placed as close to the front edge as possible (to avoid crowding the wiring).

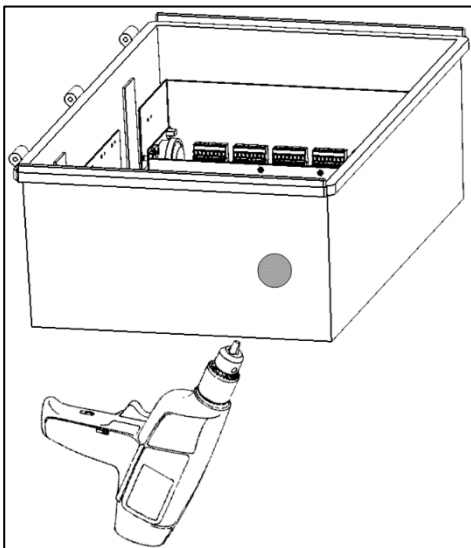

Figure 11: Drilling on the Bottom

3. Clean the holes from plastic shards. Verify that rims of holes are smooth.

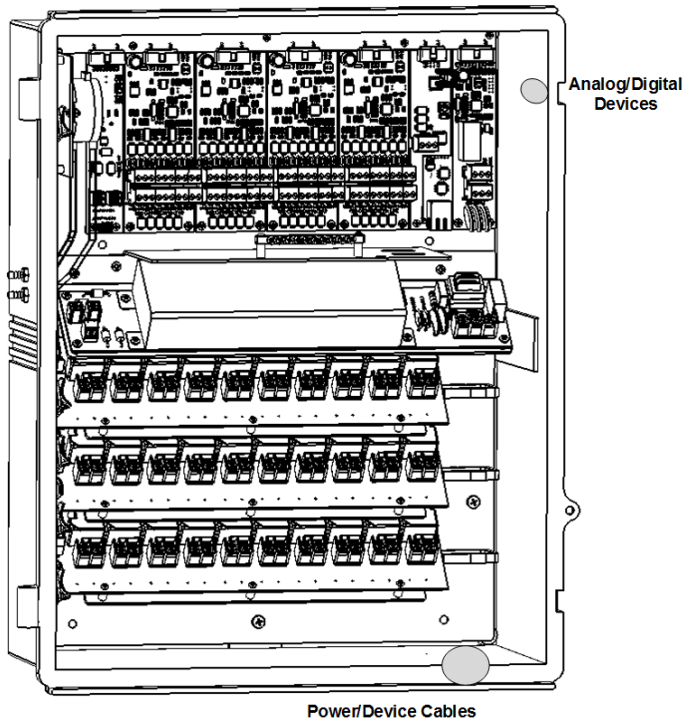

Figure 12: Hole locations

5.2 One Pro

- What comes in the Package
- Knockouts
- Mounting

5.2.1 WHAT COMES IN THE PACKAGE

- 1 One Pro unit
- Two hanging brackets
- 12 screws

5.2.2 KNOCKOUTS

On the bottom and side of the One Pro are knockouts used to route the low and high voltage cables.

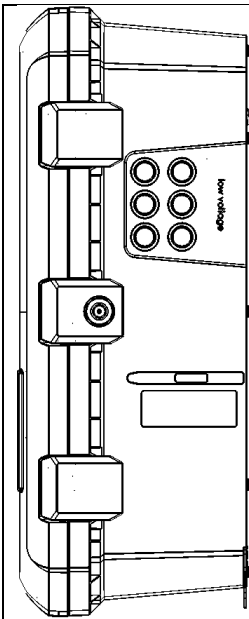

Figure 13: Low Voltage Knockouts

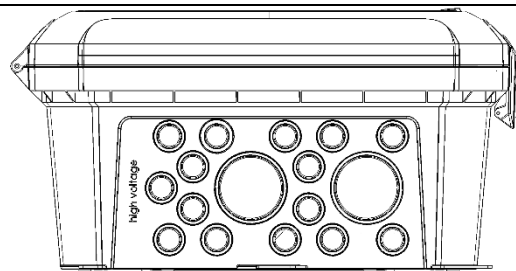

Figure 14: High Voltage Knockouts

- Using a screwdriver and a hammer, gently apply pressure to the knockouts.
- Only open up the holes that you require.
- Munters recommends removing the knockouts before mounting the unit.

5.2.3 MOUNTING

One Pro comes with two hanging brackets.

➡ **Hang the One Pro on a wall capable of supporting the unit's weight!**

1. Use the supplied screws to attach the bracket to the wall.

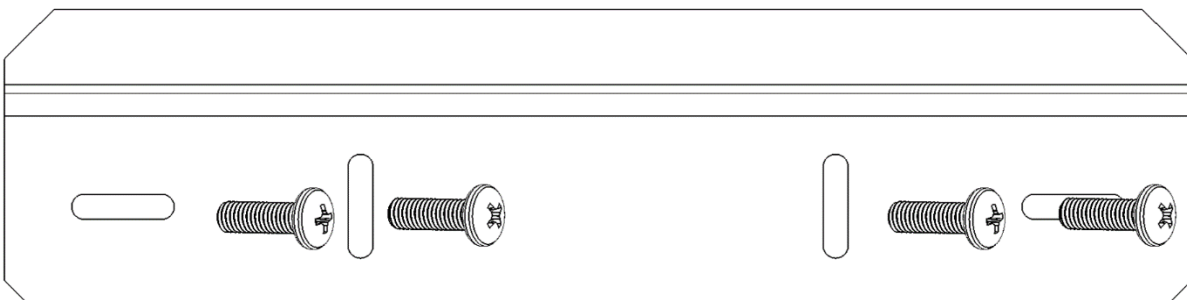

Figure 15: Wall bracket

2. Attach to the One Pro:
 - the second hanging bracket
 - the securing brackets

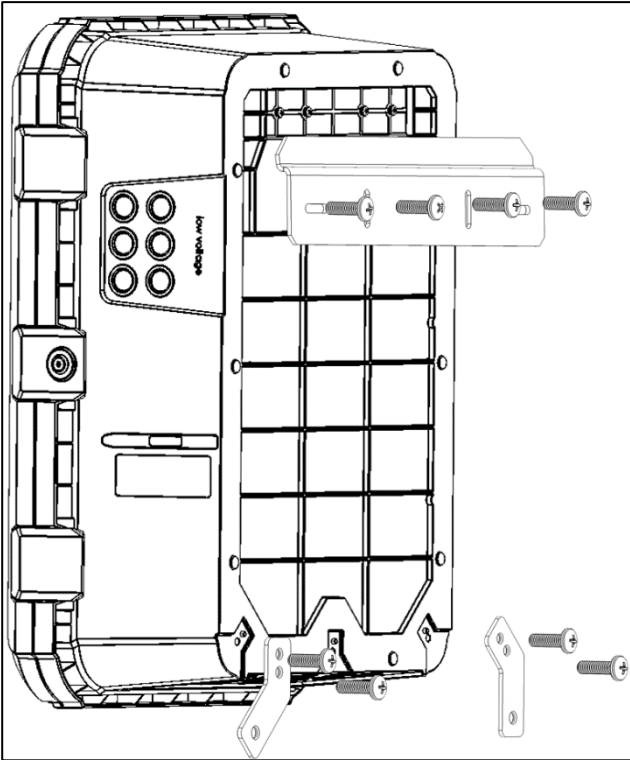

Figure 16: Unit brackets

3. Hang the One Pro on the wall bracket and screw the securing brackets to the wall.

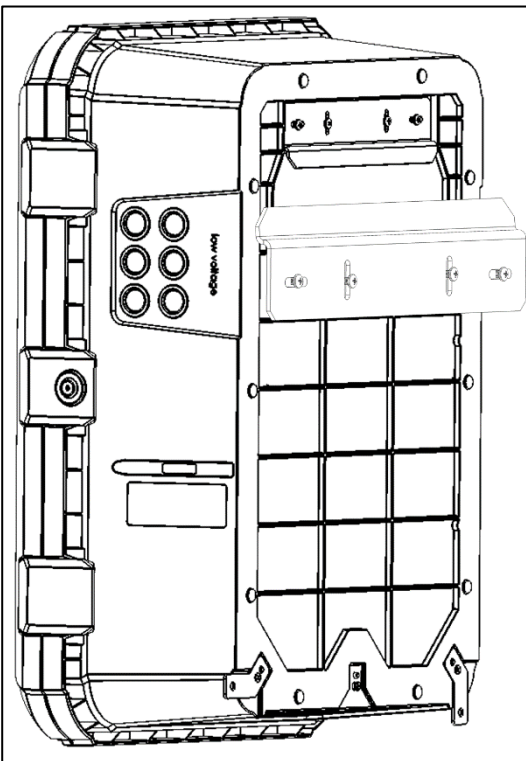

Figure 17: Mounting Completed

6 High Voltage Wiring

This section details how to wire the controller's high voltage wiring:

WARNING! Before beginning, disconnect the power supply!

CAUTION Only a qualified electrician may perform the electrical installation!

- Power Supply, page 22
- RPLP Wiring, page 23
- Relay Wiring, page 23
- Winch Card Relay Wiring , page 26
- Completing the Wiring, page 28

CAUTION Avoid mixing high voltage wiring with sensor and low voltage wiring. Keep the controller as far as possible from heavy contactor boxes and other sources of electrical interference.

6.1 Power Supply

- Main grounding wire **should come** connected to the ground terminal (1).
 - Connect electricity to the controller power supply (2).
 - Connect the grounding strip to the grounding rod (3).
- 100 - 240 VAC, 50/60 Hz; USA: L1, L2; ROW line, neutral (4)

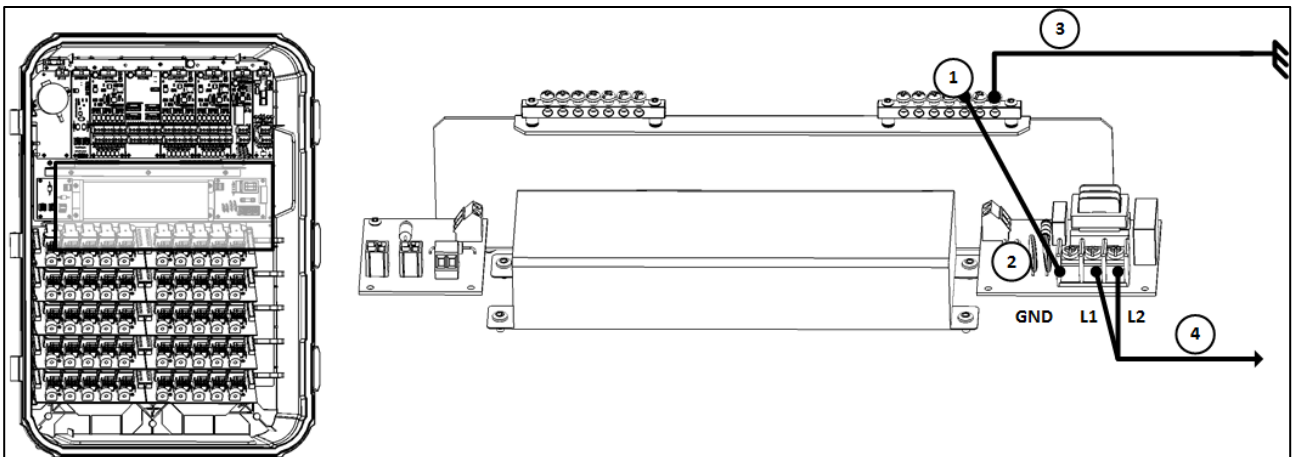

Figure 18: Power Supply Wiring Diagram

6.2 RPLP Wiring

The following section details how to wire an RPLP Lighting Protector unit to the power supply.

CAUTION Install the RPLP, 230 V only (part number P-RPLP-1-V2)!

On the RPLP's protected side:

1. Connect the RPLP grounding wire to the One Pro grounding terminal.
 2. Connect the RPLP Neutral terminal to the One Pro L1 terminal.
 3. Connect the RPLP Line terminal to the One Pro L2 terminal (4).
- 100 – 240 VAC, 50/60 Hz
 - USA: ground, L1, L2
 - ROW Ground, line, neutral

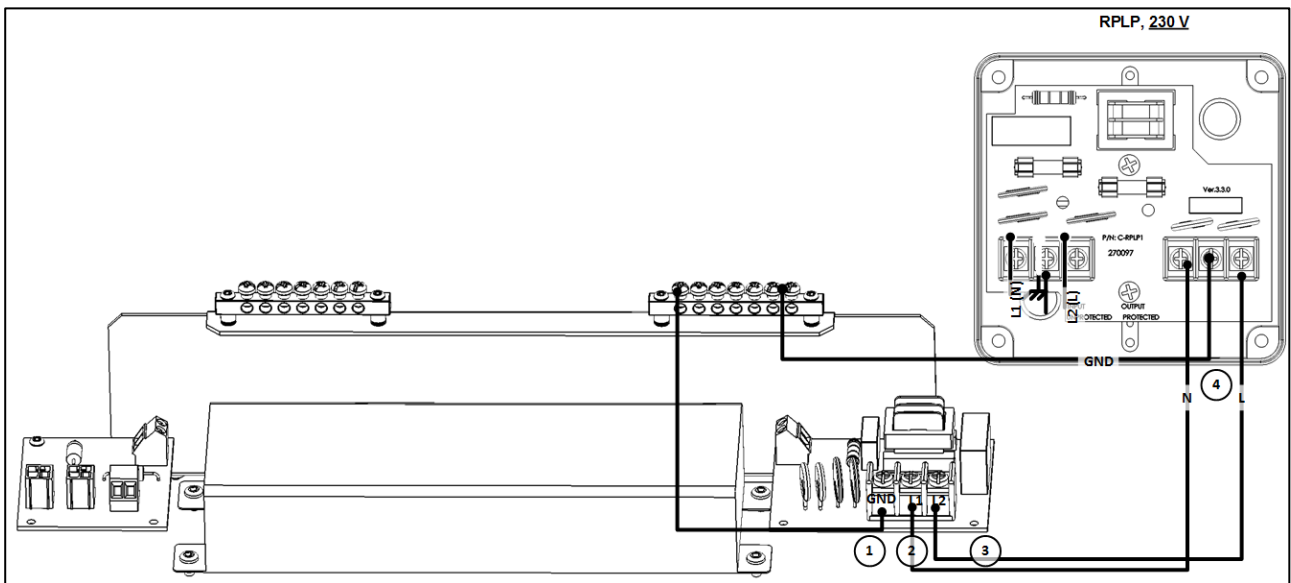

Figure 19: Wiring the RPLP

6.3 Relay Wiring

- Platinum Pro Relay Wiring
- One Pro Relay Wiring
- Final Steps

6.3.1 PLATINUM PRO RELAY WIRING

This procedure details how to connect output relays to poultry house devices.

1. Connect the control phase commons to the relays' contacts (the common wire to all relays with the same function).

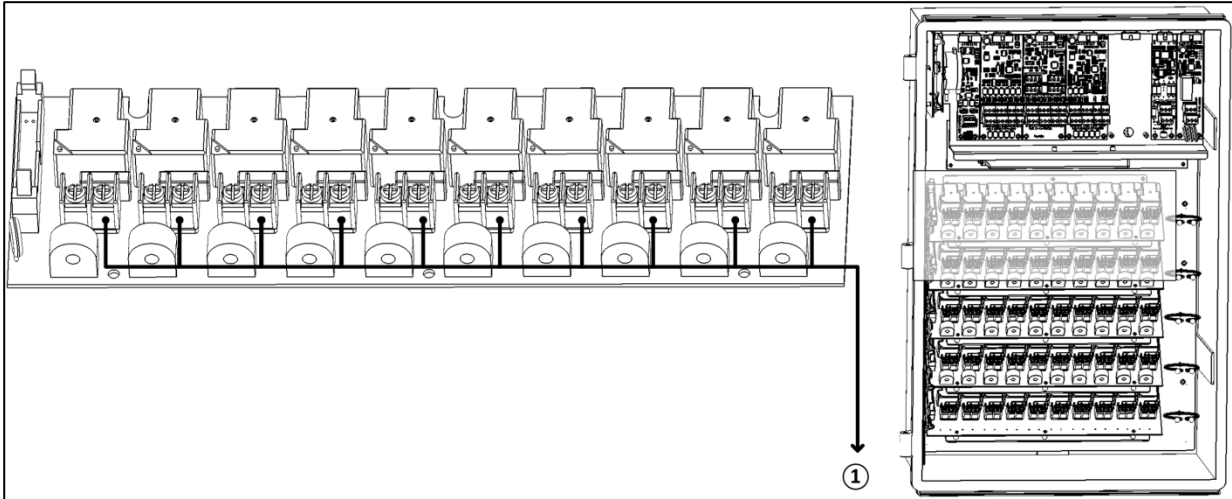

Figure 20: Control Phase Commons

Figure 22 key

1	Phase common
---	--------------

2. Connect the relay cables to each inlet/curtain/device.

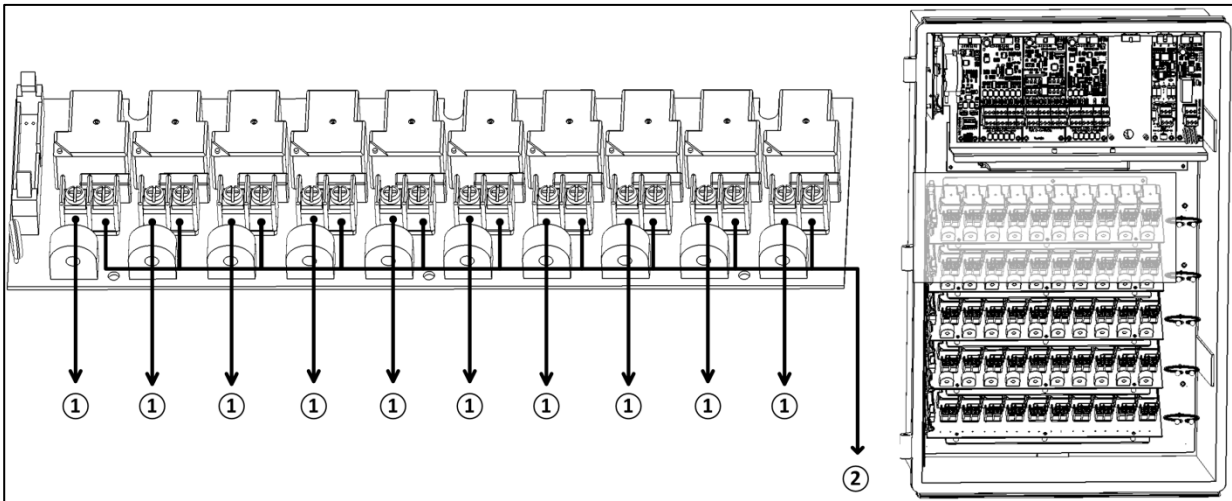

Figure 21: Relay Cable Connections

Figure 21 key

1	Cable to device
---	-----------------

2	Phase commons
---	---------------

6.3.2 ONE PRO RELAY WIRING

This procedure details how to connect output relays to poultry house devices.

1. Connect the control phase commons to the relays' contacts (the common wire to all relays with the same function).

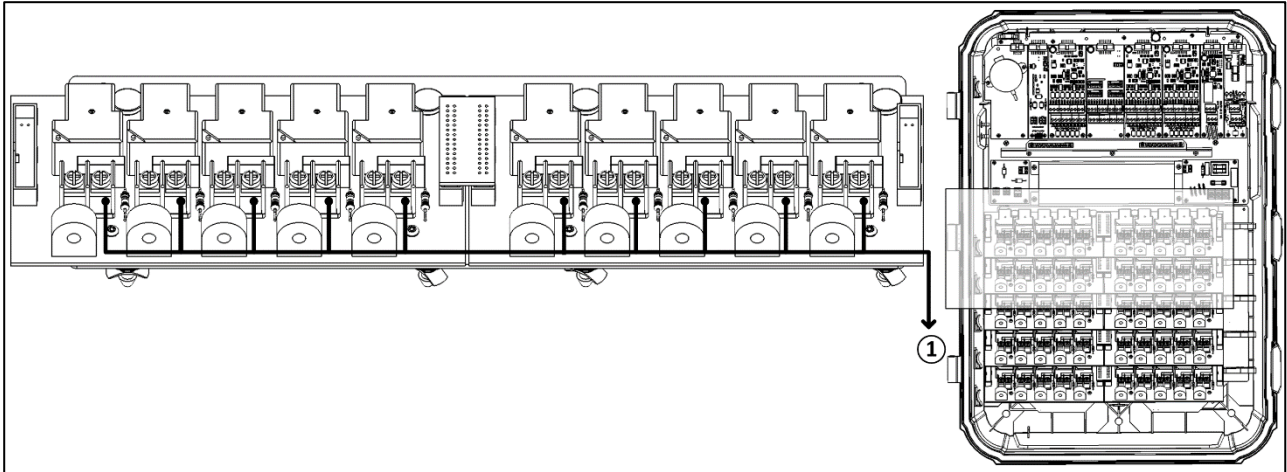

Figure 22: Control Phase Commons

Figure 22 key

1	Phase common
---	--------------

2. Connect the relay cables to each inlet/curtain/device.

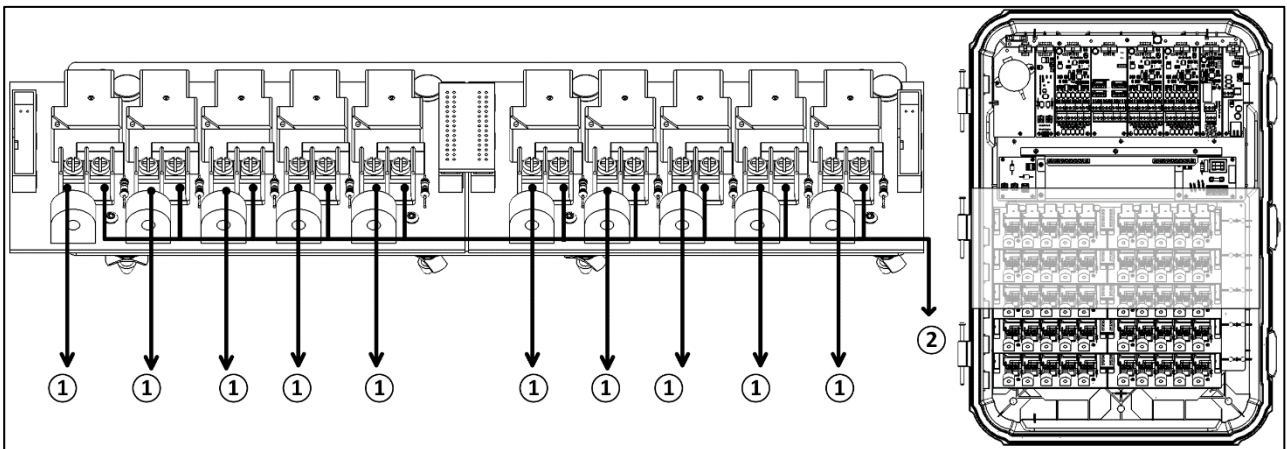

Figure 23: Relay Cable Connections

Figure 23 key

1	Cable to device
---	-----------------

2	Phase commons
---	---------------

6.3.3 FINAL STEPS

1. Locate the bag of stickers placed on the inside of the One Pro door.
2. On the sticker below each relay, write the name of the device connected to the relay.

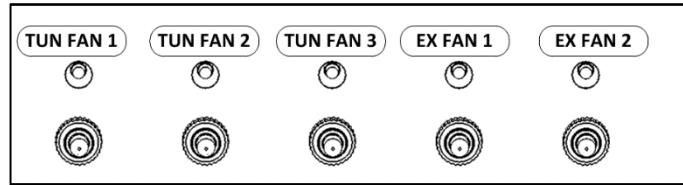

Figure 24: Controller labels

3. On the front of the controller, place the appropriate label above the switch that corresponds with the electrical setup.

6.4 Winch Card Relay Wiring

This procedure details how to connect Winch Cards to the inlets. Winch cards simplify backup (opening air sources such as inlets) in a power/heating event.

Winch Cards are optional. Users employing a RBU-27 SE do not require Winch Cards. Munters recommends that users employing a RBU-5 or RBU-3 install Winch Cards.

- Platinum Pro Winch Card Relay Wiring
- One Pro Winch Card Relay Wiring

6.4.1 PLATINUM PRO WINCH CARD RELAY WIRING

NOTE Use relays 7 – 10 for winch card relays. Winch cards are equipped with two Normally Close relays.

1. Connect separate control phase commons for each inlet or curtain.

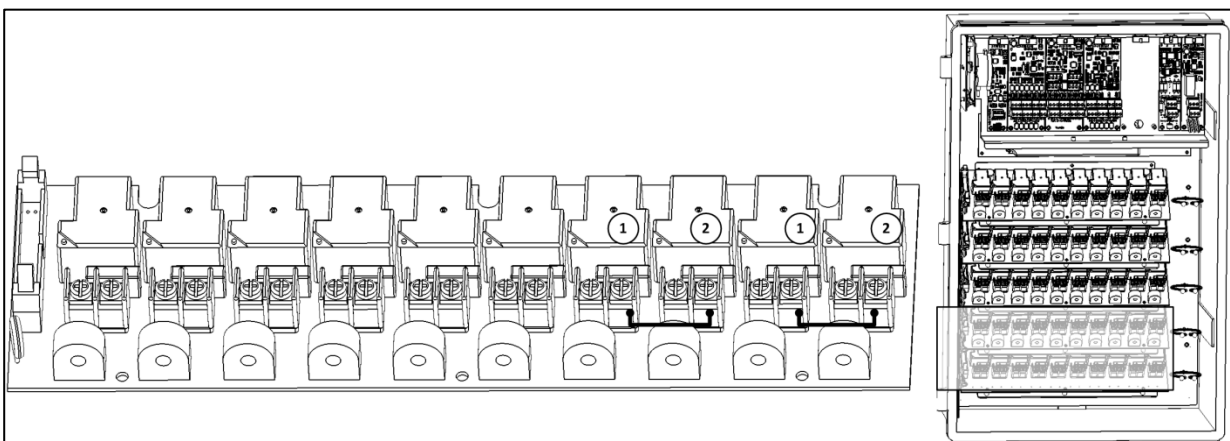

Figure 25: Winch Card Control Phase Commons

Figure 25 key			
1	Open curtain (Normally Open Relay)	2	Close curtain (Normally Open Relay)

2. Connect the output wires to the required device.

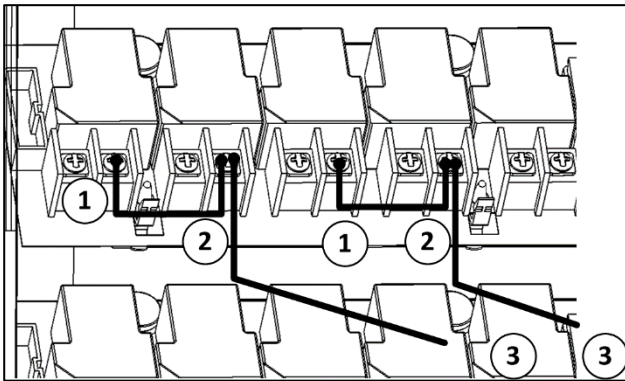

Figure 26: Connecting the Output Wire to Inlets/Curtains

Figure 26 key			
1	Open curtain (Normally Closed (NC) relay is wired to the opening gear)	3	Connect control phase wire to: L1 or L2 power port OR Backup device
2	Close curtain (Normally Open (NO) relay is wired to the opening gear)		

6.4.2 ONE PRO WINCH CARD RELAY WIRING

NOTE Use the relays on the right hand side only. Winch cards are equipped with two Normally Close relays.

1. Connect separate control phase commons for each inlet or curtain.

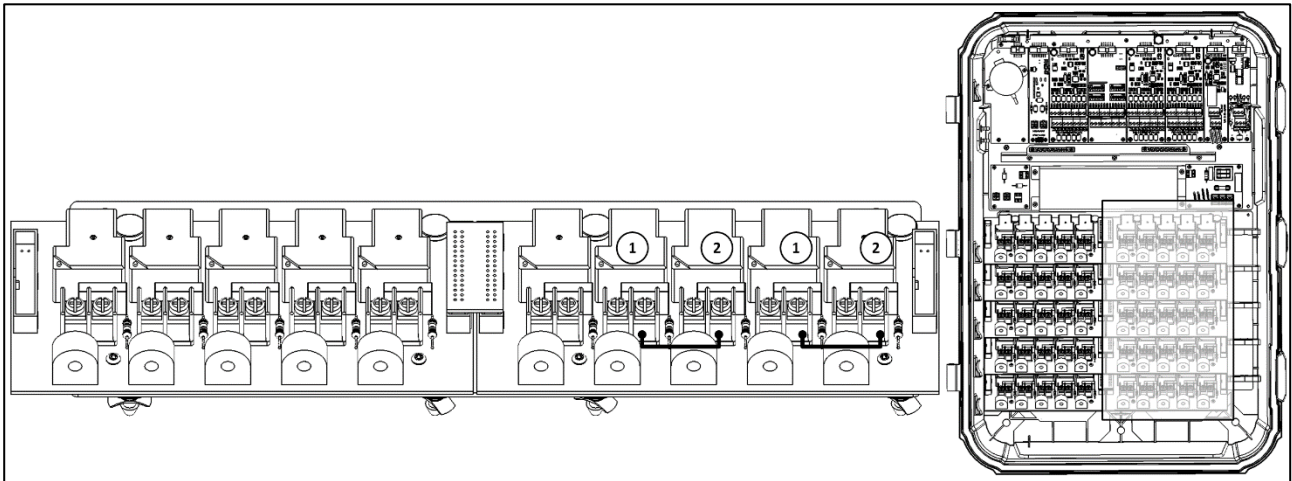

Figure 27: Winch Card Control Phase Commons

Figure 27 key			
1	Open curtain (Normally Open Relay)	2	Close curtain (Normally Open Relay)

2. Connect the output wires to the required device.

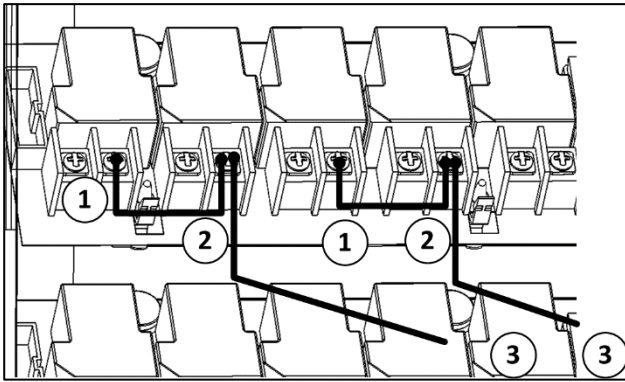

Figure 28: Connecting the Output Wire to Inlets/Curtains

Figure 28 key			
1	Open curtain (Normally Closed (NC) relay is wired to the opening gear)	3	Connect control phase wire to: L1 or L2 power port OR RBU device
2	Close curtain (Normally Open (NO) relay is wired to the opening gear)		

6.5 Completing the Wiring

- Platinum Pro: Tie the cables together with tie wraps and route them as shown (through the high voltage wiring holes drilled as shown in Drilling, page 17).
- One Pro: Tie the cables together with tie wraps and route them through the knockouts.

7 Low Voltage Wiring

- Analog Input Wiring, page 34
- Weather Station Wiring, page 35
- Digital Input Wiring, page 37
- Analog Output Wiring, page 38
- Alarm Card Wiring, page 39
- Communication Card Wiring, page 40
- RS-485 Termination, page 41

7.1 Analog Input Wiring

One Pro's analog input card (P/N: C-P3-RAIC12) supports up to 12 analog devices: temperature, light, CO2, and humidity sensors, wind direction detectors, and potentiometers. The analog input cards include of surge and lightening protection circuits and do not require additional external protections.

- Use 22 AWG or lower, shielded cable only!
 - Connect every analog input device's shield to the controller's safety ground!
 - Every COM input is correct and more than one sensor can be connected to a COM input.
-
- Analog Card DIP Switches
 - Analog Input Wiring Diagram for Temperature Sensors
 - Analog Input Wiring Diagram for CO2 and Light Sensor
 - Analog Input Wiring Diagram for Potentiometers
 - Analog Input Wiring Diagram for Humidity Sensors
 - Analog Input Wiring Diagram for Ammonia Sensors

7.1.1 ANALOG CARD DIP SWITCHES

The RAIC-12 has the following ports:

- T1 – T8: Eight dedicated temperature sensor inputs
- IN1 – IN4: Four input ports defined using dip switches
- Four COM ports
- +12V: Two dedicated humidity sensor voltage (12V) ports
- 3.3V: Two dedicated potentiometer voltage (3.3V) ports

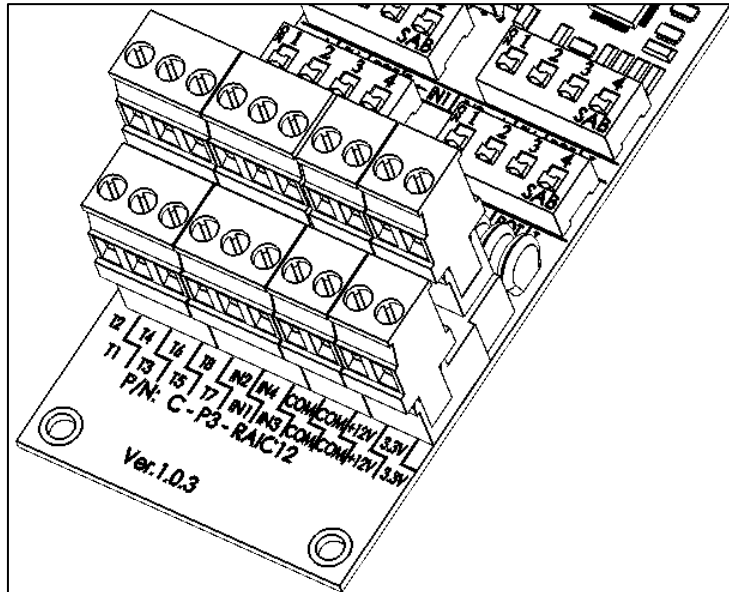

To configure the IN1 – IN4 ports move one dip switch to ON in each set of ports.

CAUTION Leaving all switches in the Off position or placing more than one switch in the On position in a set nullifies those functions!

- DIP Switch 1: 4 – 20 mA (CO₂ and light sensors)
- DIP Switch 2: 0 – 5V (humidity)
- DIP Switch 3: Potentiometer and wind direction sensors
- DIP Switch 4: Temperature sensor

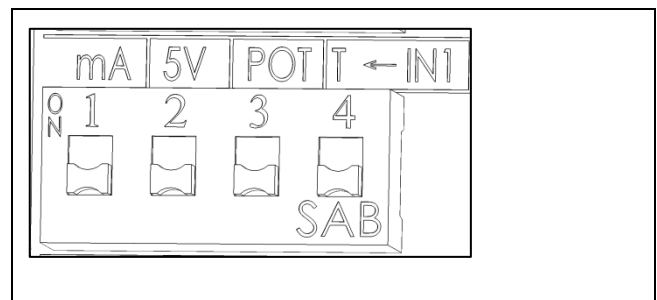

7.1.2 ANALOG INPUT WIRING DIAGRAM FOR TEMPERATURE SENSORS

- Connect the temperature sensor to an input and COM port. Terminals 1 - 8: These inputs support temperature sensors only.
- IN1 – IN4: These are optional temperature sensor inputs (turn DIP Switch 4 (T) on each set as required).

Figure 29 shows an example of temperature sensor wiring.

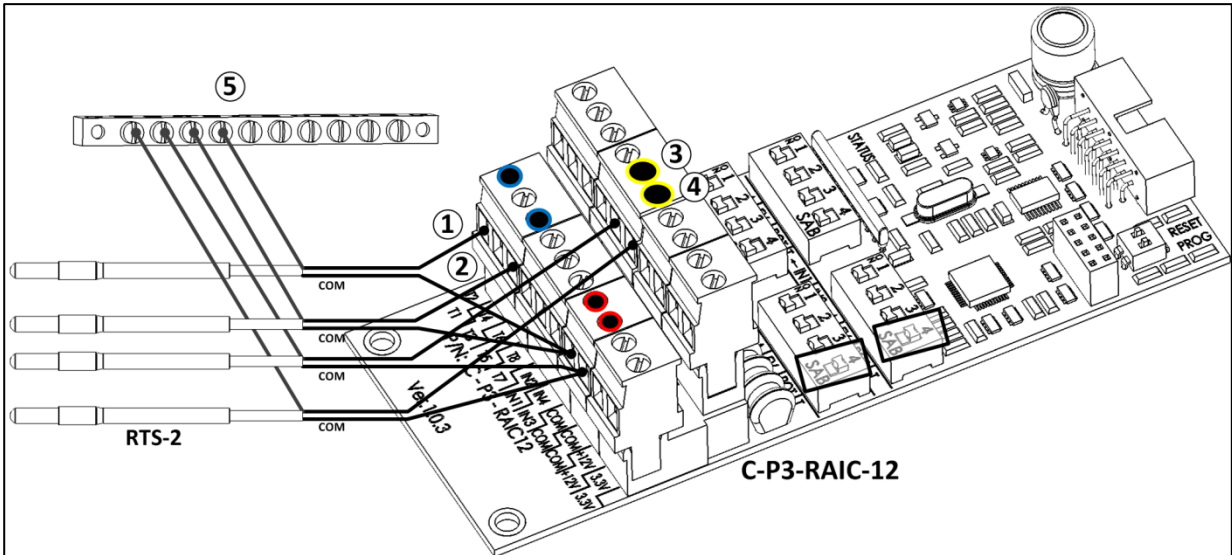

Figure 29: Temperature Sensor Wiring

Figure 29 key			
1	T1 input	4	IN4 input
2	T3 input	5	Shield wire connected to grounding strip
3	IN2 input		

7.1.3 ANALOG INPUT WIRING DIAGRAM FOR CO2 AND LIGHT SENSOR

1. Connect each sensor to an input and COM port.
2. IN1 – IN4: Turn DIP Switch 1 on each set as required.

Figure 30 shows an example of CO2 and light sensor wiring

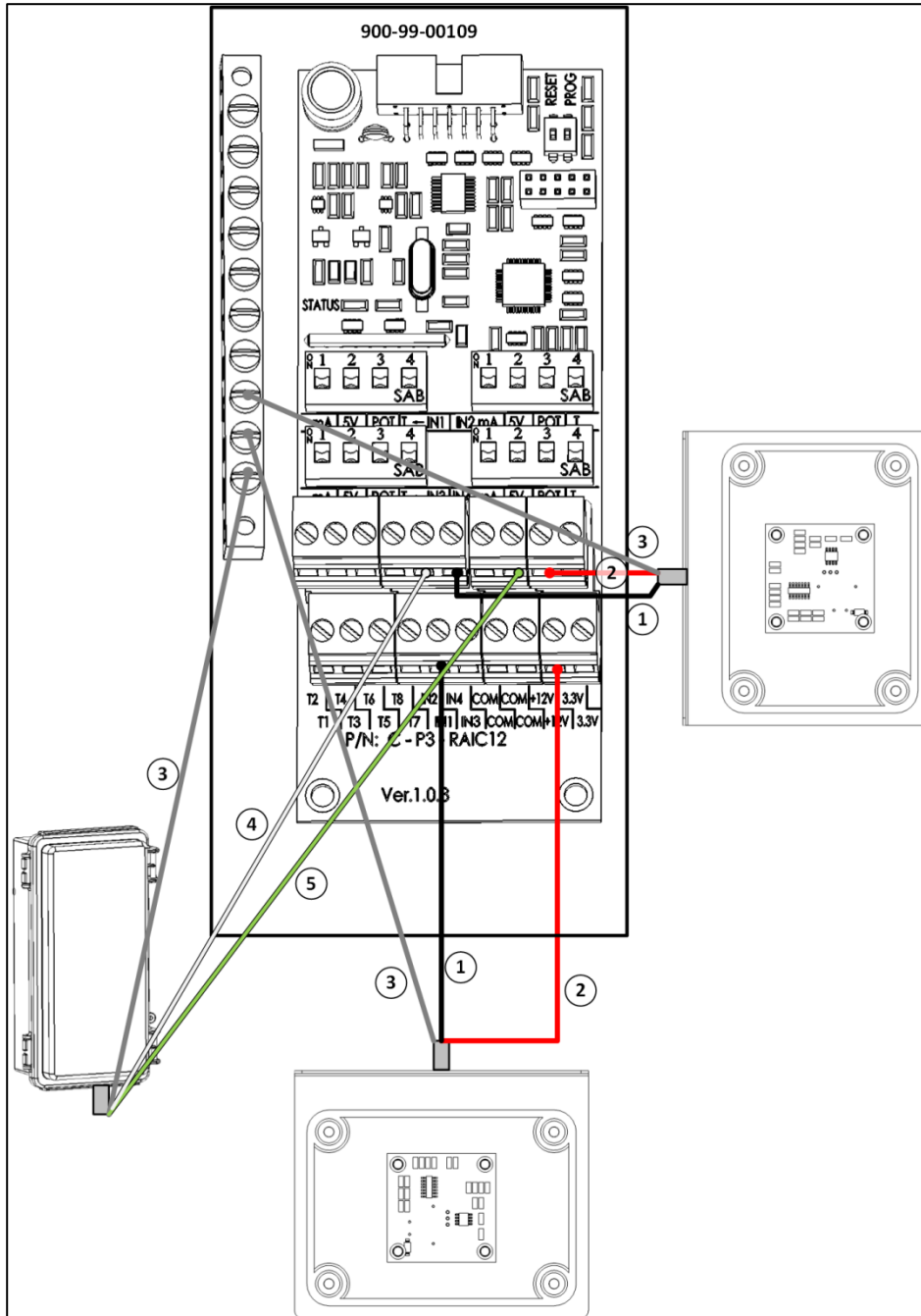

Figure 30: Light and CO2 Sensors Wiring

Figure 30 key			
1	Black wire to IN 1 – IN 4	4	White wire to IN 1 to IN 4
2	Red wire to 12+	5	Green wire to COM
3	Shield wire		

7.1.4 ANALOG INPUT WIRING DIAGRAM FOR POTENTIOMETERS

1. Connect each potentiometer (10 - 20 KOhm) to an input, a COM, and 3.3V port.
2. IN1 - IN4: Turn DIP Switch 3 (POT) on each set as required.

Figure 31 shows an example potentiometer wiring.

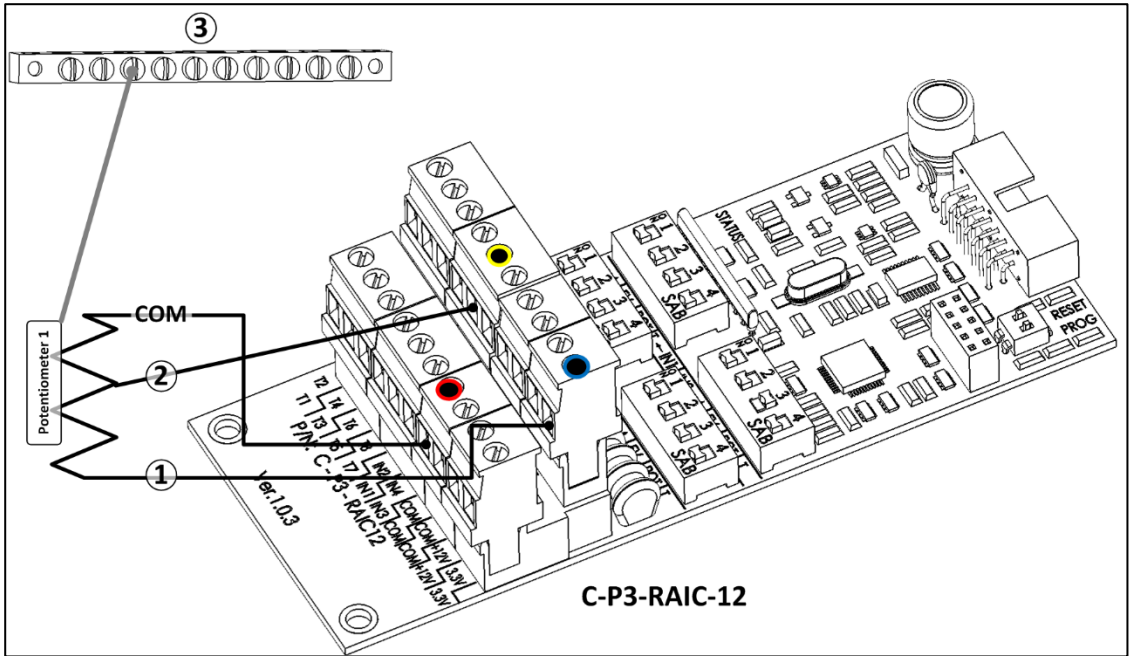

Figure 31: Potentiometer Wiring

Figure 31 key			
1	3.3V	3	Shield wire connected to grounding strip
2	IN2		

7.1.5 ANALOG INPUT WIRING DIAGRAM FOR HUMIDITY SENSORS

1. Connect each humidity sensor to input, a COM, and +12V port.
2. IN1 - IN4: Turn DIP Switch 2 on each set as required.

Figure 32 shows an example humidity sensor wiring setup.

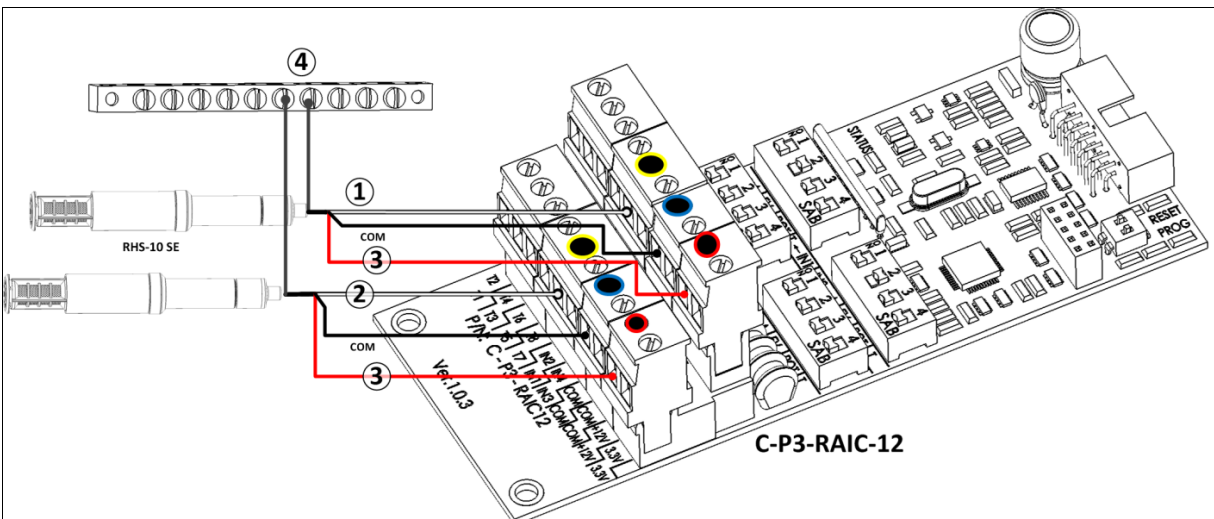

Figure 32: Humidity Sensor Wiring

Figure 32 key			
1	IN2 input	3	+12V
2	IN1 input	4	Shield wire connected to grounding strip

7.1.6 ANALOG INPUT WIRING DIAGRAM FOR AMMONIA SENSORS

1. Connect:

- Sensor green wire to power supply black wire. Connect the combined wire to COM.
- Sensor white wire (24VDC power source) to power supply red wire (24V).
- Sensor brown wire:
 - Connect the wire to a 10 kohm resistor.
 - Connect the resistor to port IN1, IN2, IN3, or IN4.

2. On the Analog Input Card, set the corresponding dipswitch to the 5V position (dipswitch 2).

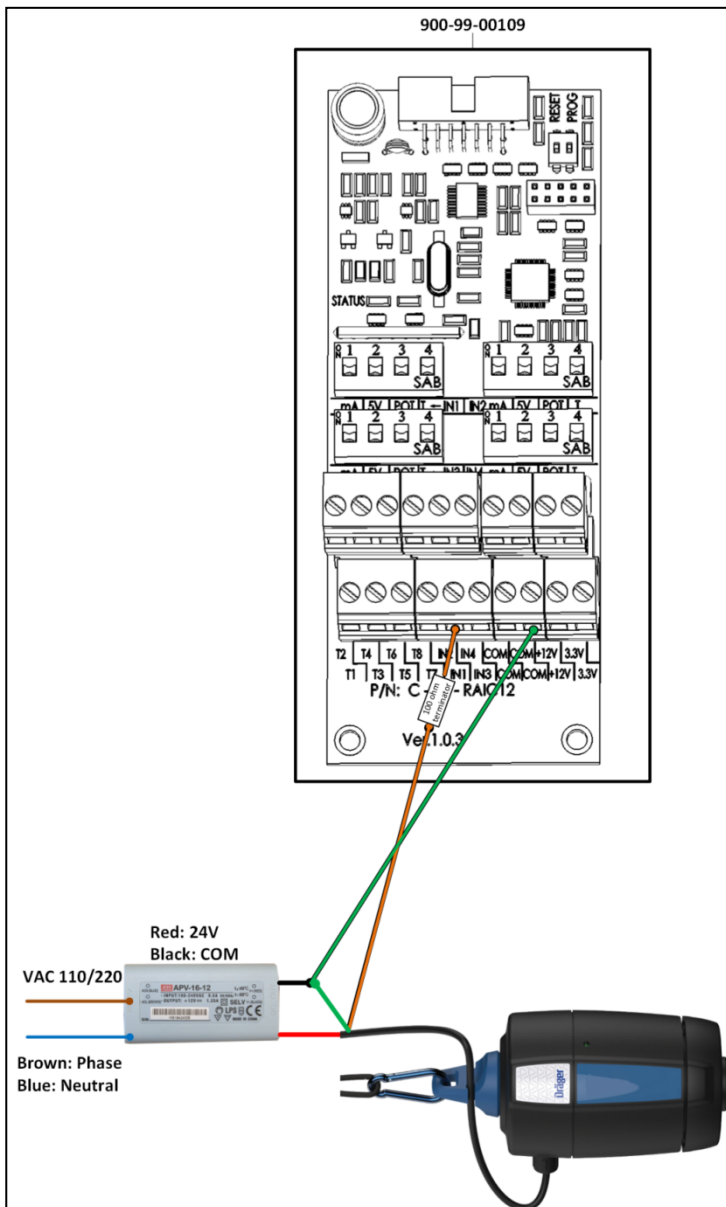

Figure 33: Ammonia Sensor Wiring

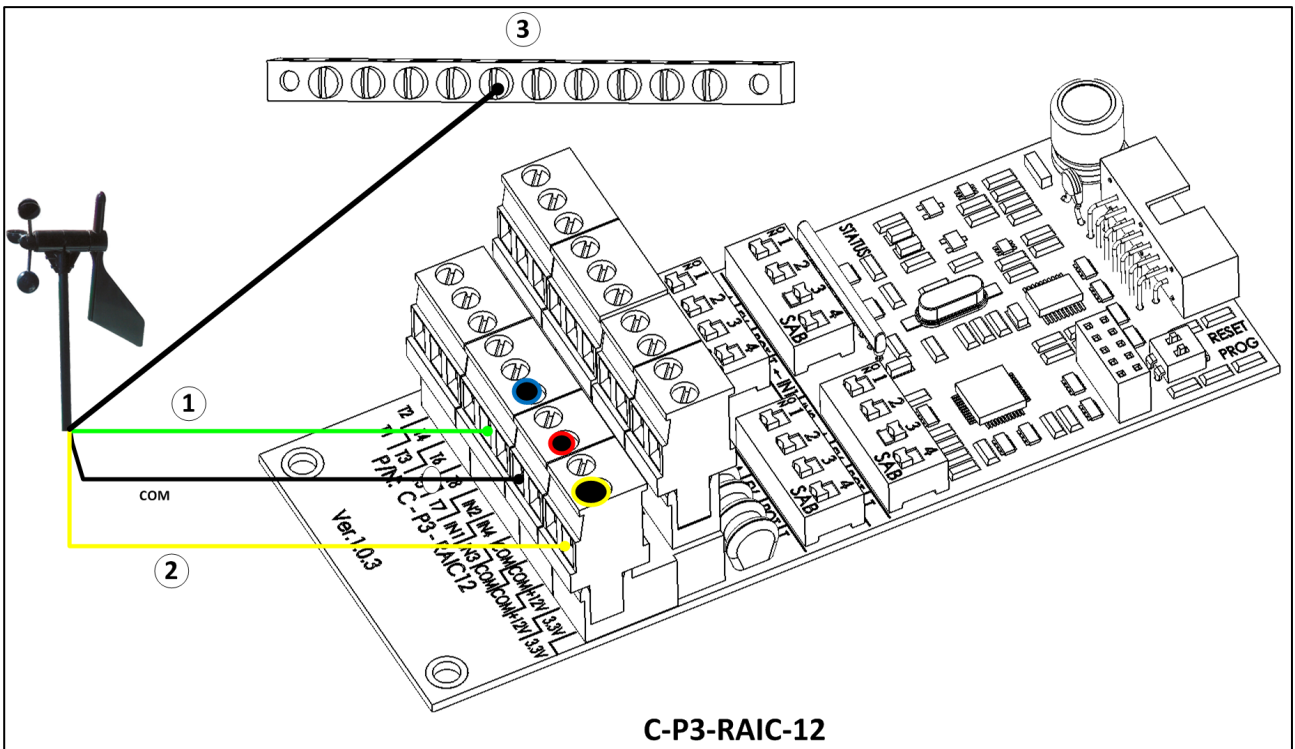

Figure 36: Weather Station Analog Input Card

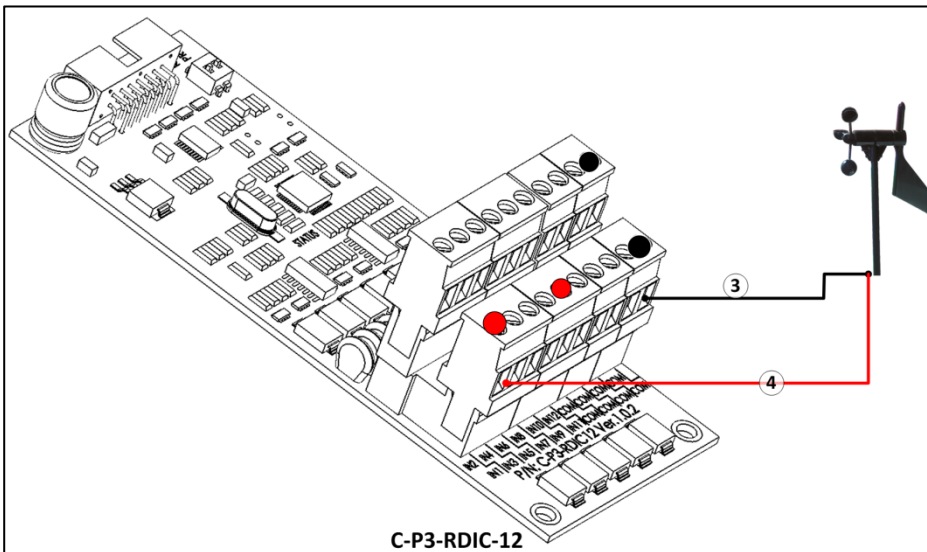

Figure 37: Weather Station Digital Input Card

NOTE If the Speed Sensor is not used, connect the red wire to the COM entry of the Analog Input Card.

Figure 35 / Figure 36 / Figure 37 key			
1	IN3	4	IN1
2	3.3V	5	Ground strip
3	COM		

7.3 Digital Input Wiring

One Pro has a Digital Input Card (P/N: C-P3-RDIC12) with 12 inputs which are used to measure digital sensors. Each input requires an input and COM port.

- It is possible to connect the common of several sensors to the same connector. However Munters recommends spreading the commons in an even manner.
- The Digital Input Card includes surge and lightning protection circuits and does not require external protections.

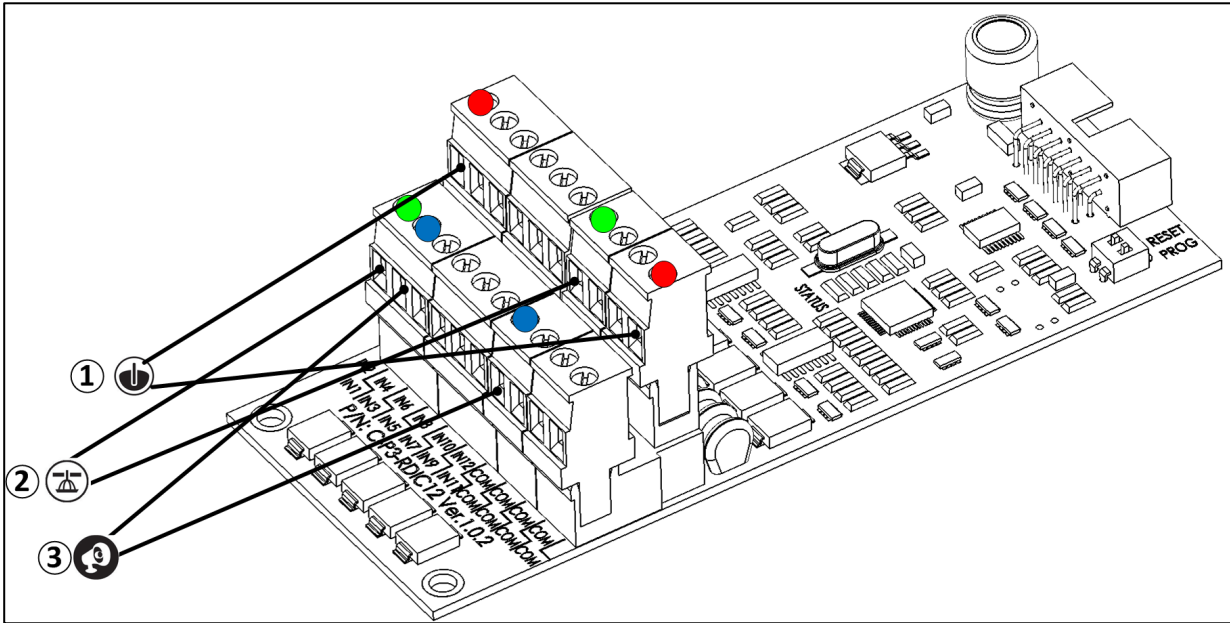

Figure 38: C-P3-RDIC12 Wiring

Figure 38 key		
1	Input 1 signal	Examples of Digital Input Devices
2	Input 2 signal	Auxiliary Alarm
3	Input 3 signal	Water Meter
		Auger Overtime
		Feed Counter
		Pump Cycle Meter
		Pump Additive Over

7.4 Analog Output Wiring

One Pro has an Analog output card (C-P3-RAOC10) with 10 outputs used to drive external units controlled by 0 – 10 VDC. The analog outputs card consists of surge and lightning protection circuits and does not require external protections.

CAUTION Connect every analog output device's shield to the controller's safety ground!

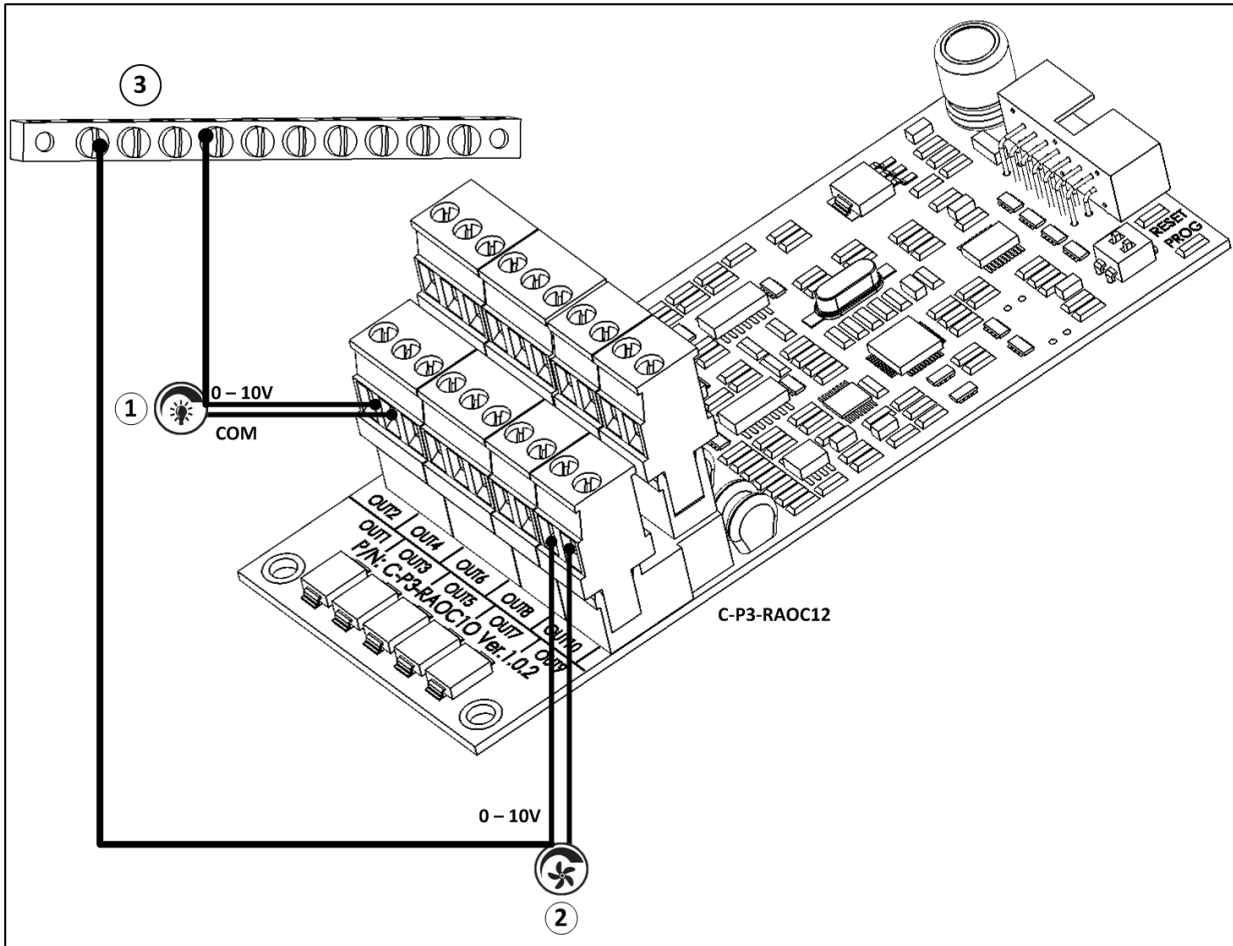

Figure 39: C-RAOC12 Wiring

Figure 39 key			
1	Output 1: Light dimmer	3	Ground strip
2	Output 8: Variable speed fan		

Examples of Analog Output Devices:

- Variable Speed Fans
- Stir Fans
- Light Dimmer

NOTE The above drawing is only an example of many possible wiring diagrams. Your particular installation may differ.

7.5 Alarm Card Wiring

Munters' Alarm Card (C-PP-P3-ALARM) provides integrated lightning protection for a single alarm device of up to 430 Volts DC. If you need to protect more than one device, use Munters' P-RLVP to protect low voltage devices or the RPLP for line voltage devices.

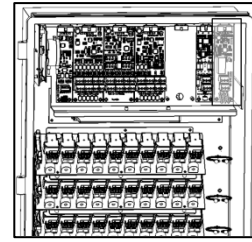

Suggested Alarm System Connection: To provide lightning protection to the alarm:

- Connect wiring of products requiring protection into the ports labeled "Protected input".
- Connect wiring of products not requiring protection into the ports labeled "Unprotected input".

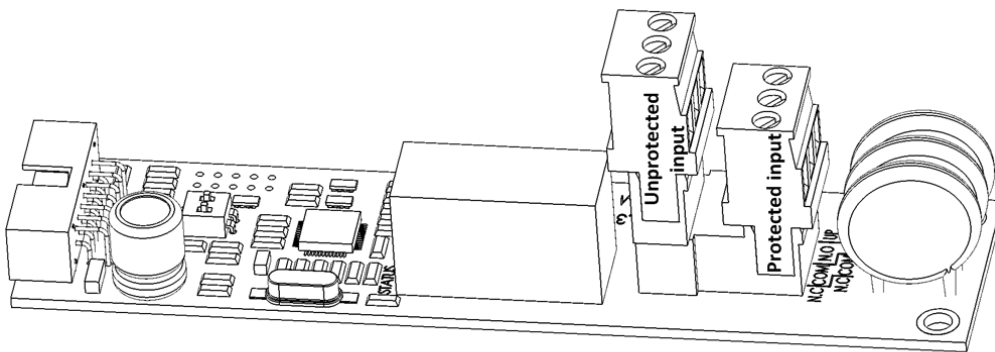

C-P3-ALARM

Figure 40: Unprotected Input/Protected Input

The alarm card provides NO (Normally Open) and NC (Normally Closed) connections on two independent terminals.

- NC connections are open
- NO connections are closed. This feature provides automatic power fail alarms if the system loses power to the alarm card.

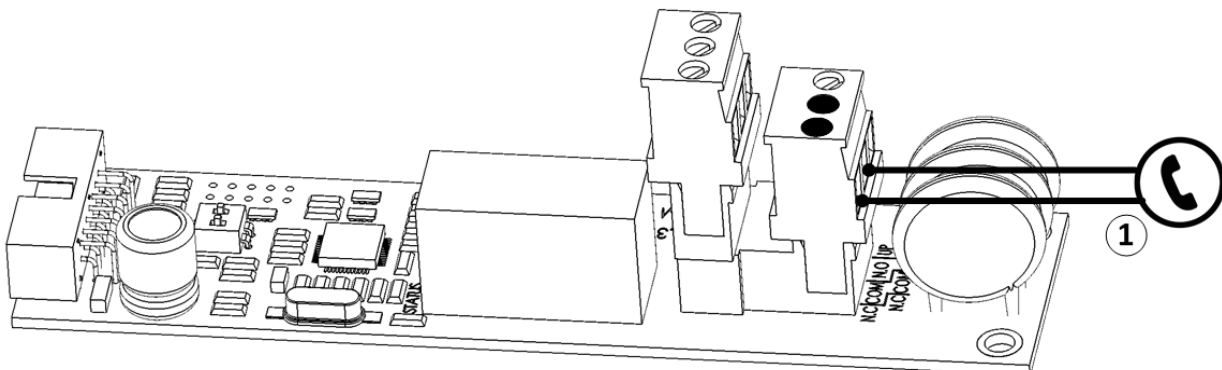

C-P3-ALARM

Figure 41: Normally Close Alarm System Wiring

Figure 41 key

1	12V dialer
---	------------

You can use the protection for other devices such as a simple siren.

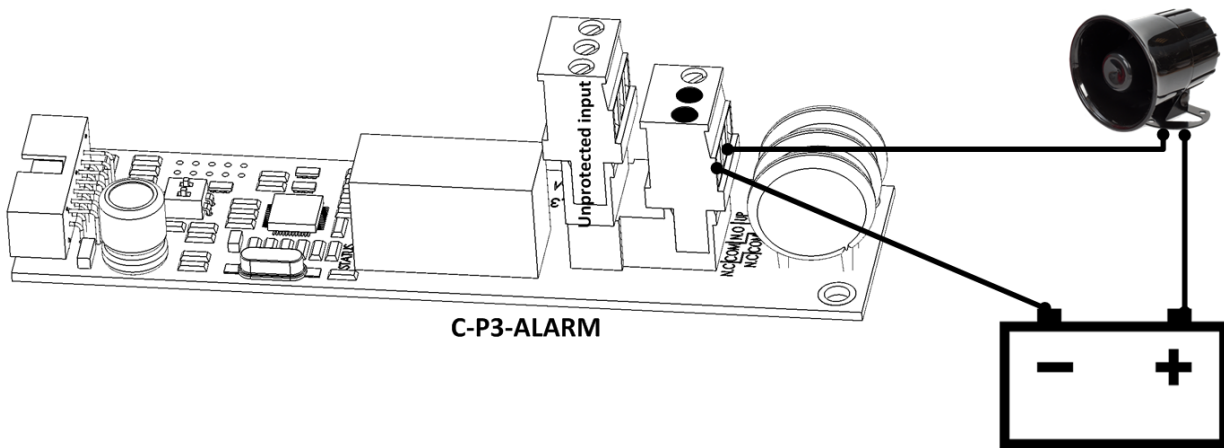

Figure 42: C-P3 Siren Wiring Diagram

Figure 42 key

- | | |
|---|-------------|
| 1 | 12V battery |
|---|-------------|

NOTE If you need to protect more than one device, use Munters' P-RLVP to protect low voltage devices or the RPLP for line voltage devices.

7.6 Communication Card Wiring

The communication option provides a means to connect a personal computer locally or remotely by modem. Connection to the computer is via a communication device. Figure 2 (page 14) shows the communication card location.

<ul style="list-style-type: none"> • RS-232 Card: 900-99-0012 	
<ul style="list-style-type: none"> • RS-485 Card: 900-99-00101 	

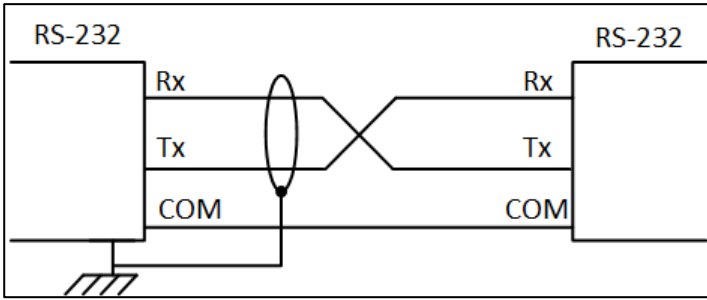

Figure 43: RS-232 Wiring

CAUTION Cross the TX-RX wiring!

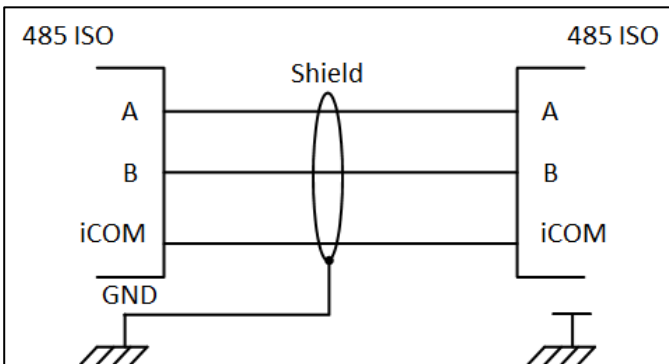

Figure 44: RS-485 Wiring

CAUTION Connect the ground shield on one side only! NEVER connect the communication COM to the power ground!

7.7 RS-485 Termination

When installing Platinum Pro/ One Pro units and connecting them to other devices, ensure that there is proper electrical termination. The following section details how and what to terminate.

- Controllers and Comm-Box
- Controllers and Communicator
- Controller, Relay Expansion, RSU-2 and HUB
- Placing the Terminator

7.7.1 CONTROLLERS AND COMM-BOX

- Comm-Box and Controller RS-485 communication cards come equipped with an onboard 120 Ohm termination resistor.
- There is no need to install an external 120 Ohm termination resistor in the controller; place a Jumper on the communication card at the unit located at the end of chain (Figure 45).

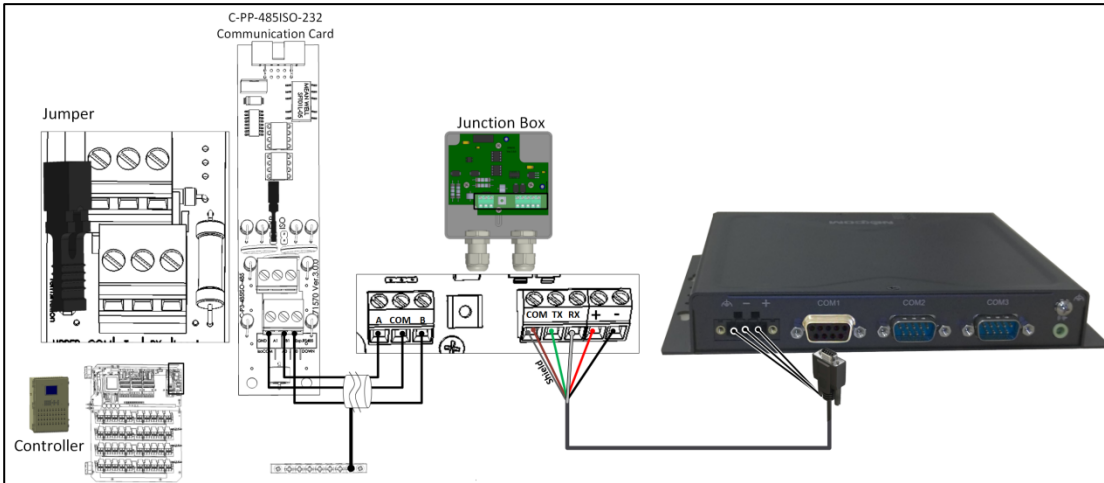

Figure 45: Comm-Box – Controller Termination

7.7.2 CONTROLLERS AND COMMUNICATOR

Refer to Figure 46.

- The controller RS-485 communication card comes equipped with an onboard 120 Ohm termination resistor.
- Place a Jumper on the controller RS-485 communication card at the unit located at the end of chain.
- If the Communicator External Box is located at the end of a chain, install a 120 Ohm termination resistor (supplied by Munters).

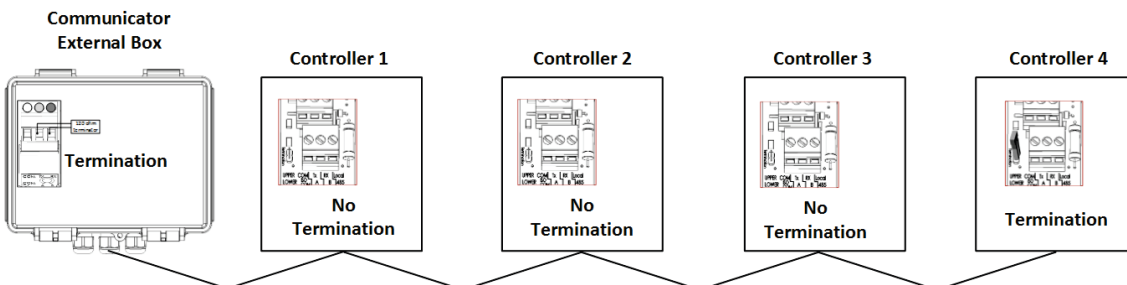

Figure 46: External Box – Controller Termination

7.7.3 CONTROLLER, RELAY EXPANSION, RSU-2 AND HUB

- The controller RS-485 communication card comes equipped with an onboard 120 Ohm termination resistor.
- Place a Jumper on the controller RS-485 communication card at the unit located at the end of chain.
- If an Expansion unit is installed at the end of a chain, install a 120 Ohm termination resistor (supplied by Munters) (Figure 47).

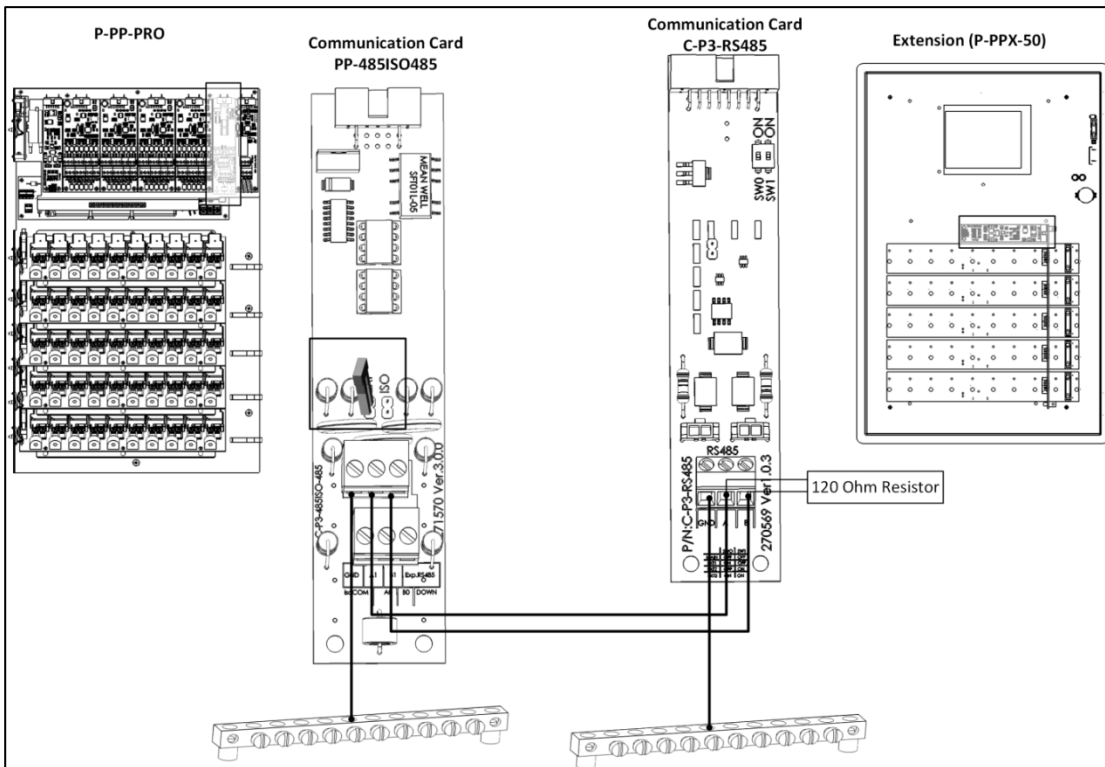

Figure 47: Expansion Box – Controller Termination

- If an RSU unit is installed at the end of a chain, install a 120 Ohm termination resistor (supplied by Munters) (Figure 48).

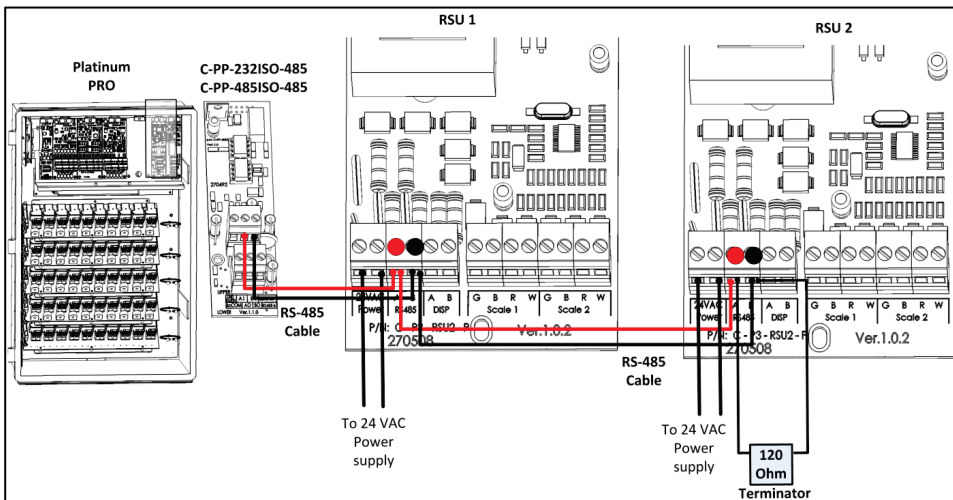
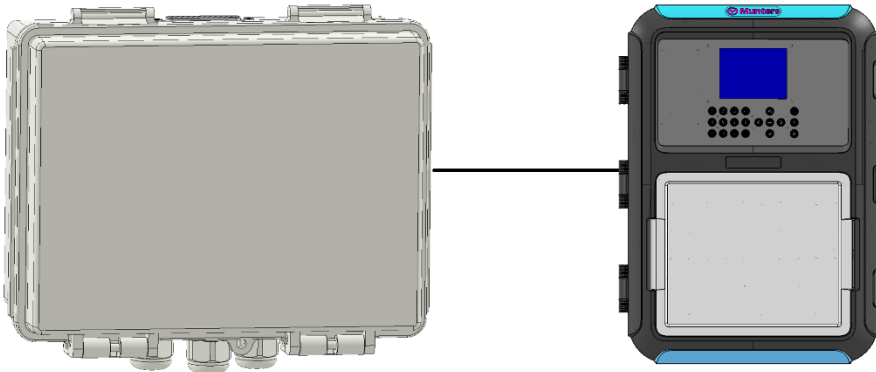

Figure 48: RSU – Controller Termination

- Additional notes:
 - If a HUB is at the end of a chain, place a jumper on the termination pins.
 - 120 Ohm termination resistor part number: 999-99-00333 "RES50 0.12K 1/4W 50PPM 5%"

No EXP Termination
ISO Termination



Communicator External
Box

EXP Termination
ISO Termination

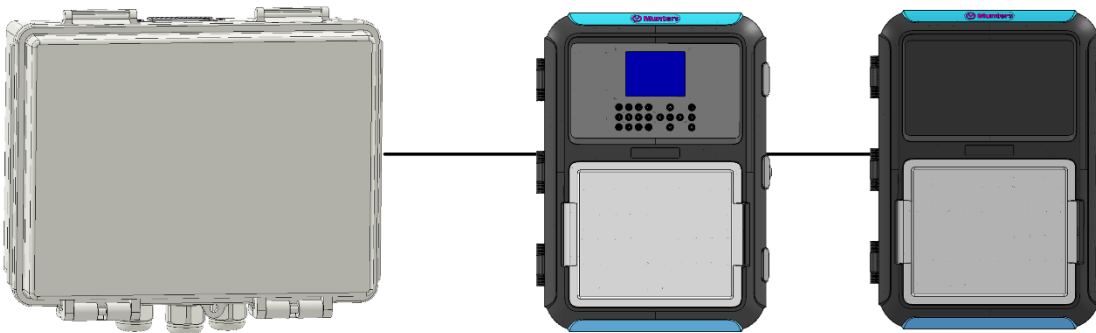

Communicator External
Box

Figure 49: Termination examples

8 Scale Card Wiring

Version 6.18 supports a scale card.

Note: There are two versions of the P3-RSC card:

- Two channel scale cards: Supports up to two bird scales only
- Six channel scale cards: Supports bird, silo, and feed scales

8.1 Bird Scale Wiring

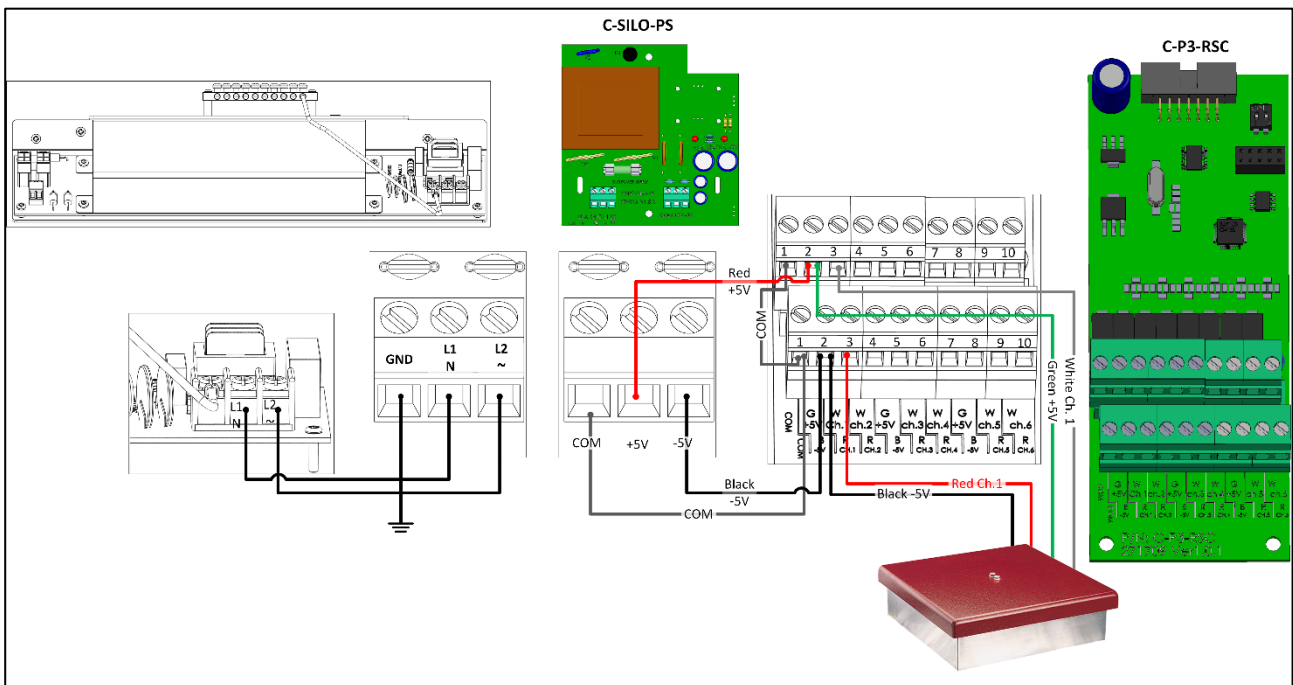

Figure 50: Bird Scale Wiring Diagram

8.2 Feed Scale Wiring

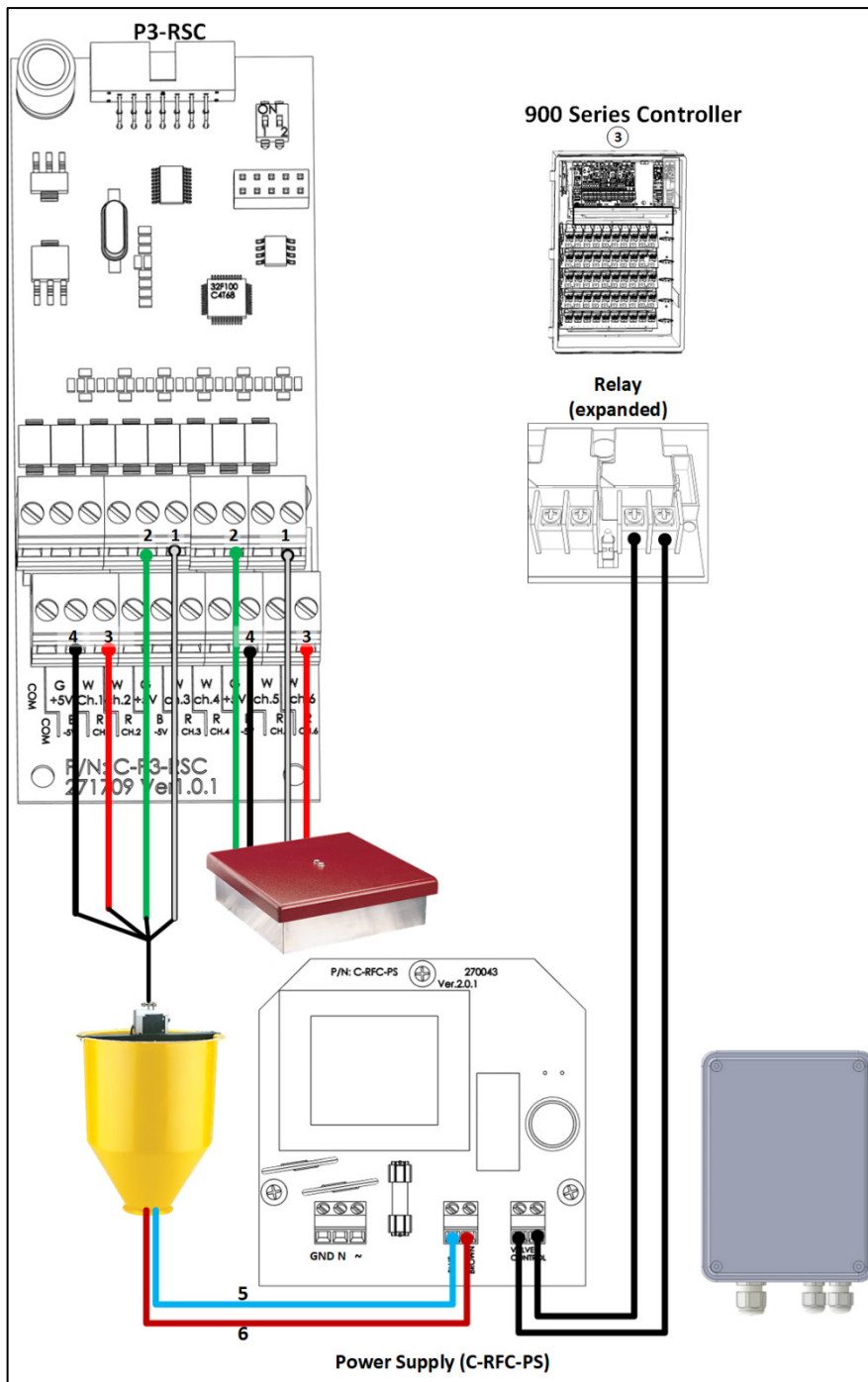

Figure 51: Feed Scale Wiring Diagram

8.3 Silo Scale Wiring

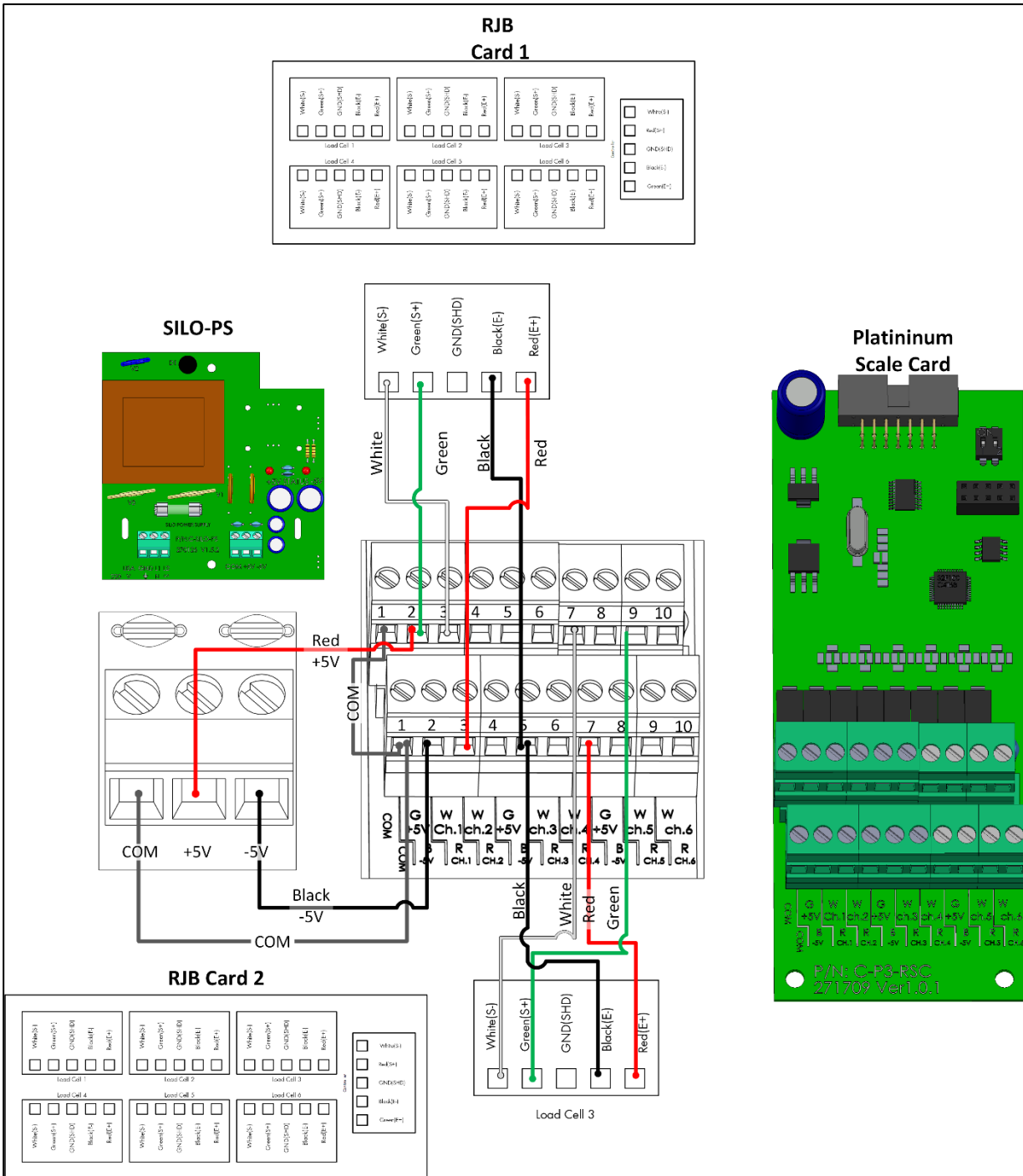

Figure 52: Silo Scale Wiring Diagram

RJB Wire	RSC Ports	
Green	2, 5, 8 (Upper)	
Black	2, 5, 8 (Lower)	
White	3, 4, 6, 7, 9, 10 (Upper)	Note: Connect each RJB white and red wire to matching ports. For example White Ch.1 and Red Ch.1
Red	3, 4, 6, 7, 9, 10 (Lower)	

9 Appendix A: Platinum Pro Metal Assembly

The Platinum Pro and Touch metal assembly consists of two elements, connected by flat ribbons:

- Front door
- Relay / card panel

- Metal Assembly Precautions
- Panels
- Panel Dimensions
- Mounting the Panels
- Connecting the Metal Panels

9.1 Metal Assembly Precautions

Ensure the following:

- The setup meets electrical, mechanical and fire enclosure requirements.
- Clearance and creepage distances are maintained.
- Grounding meets industry standards.
- Ambient temperatures do not go above product requirements (50° C).

9.2 Panels

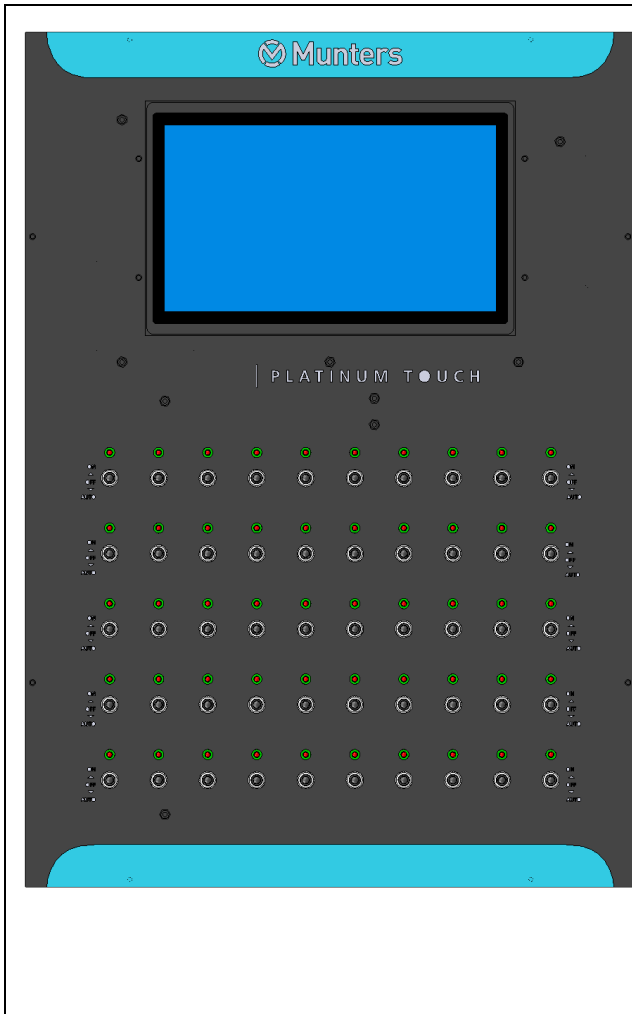

Figure 53: Platinum Pro 30 Front Panel

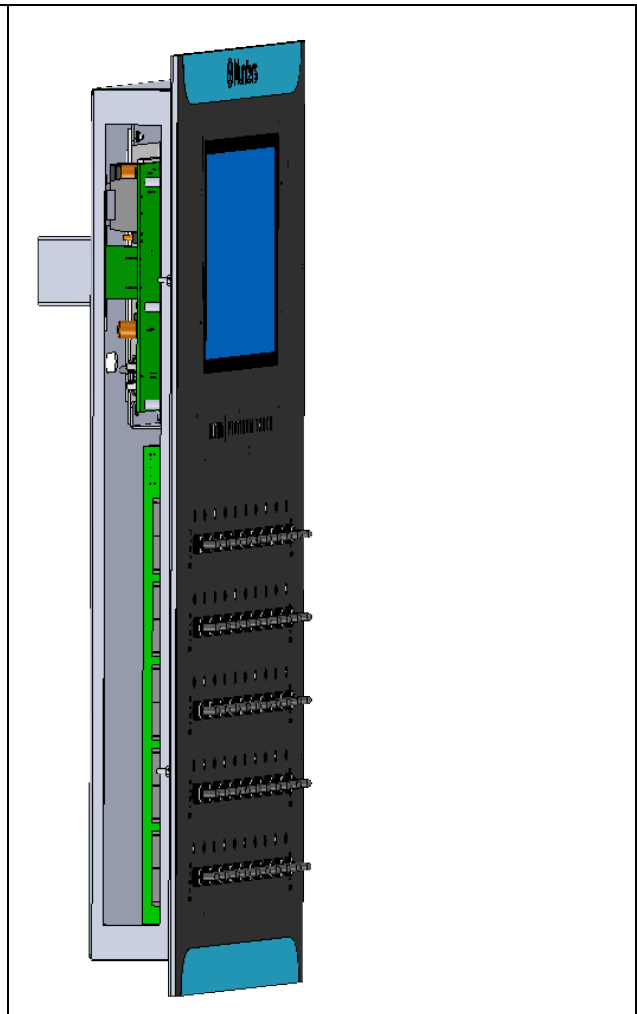

Figure 54: Platinum Pro 30 Side View

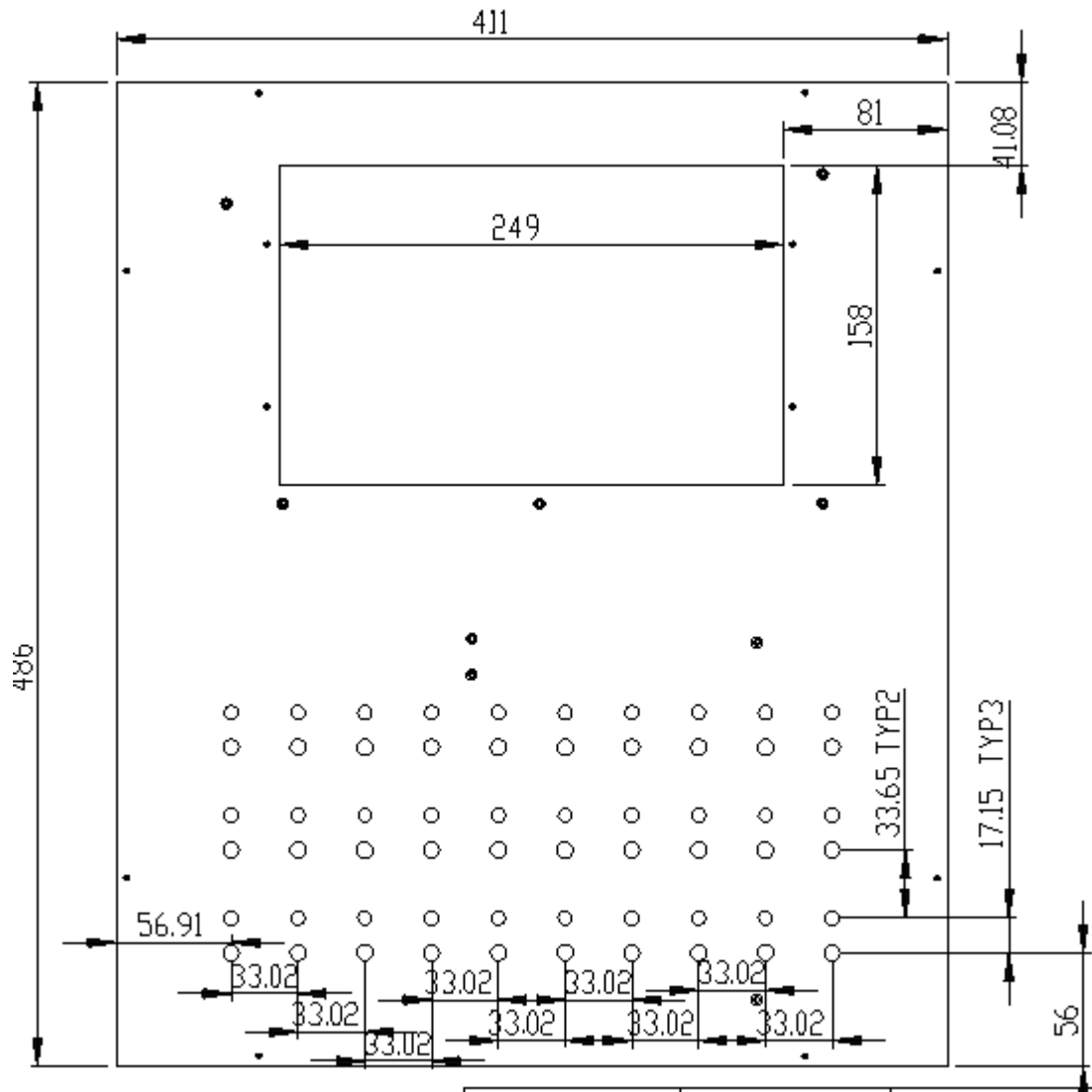

Figure 57: Platinum Touch 30 Front Panel Dimensions

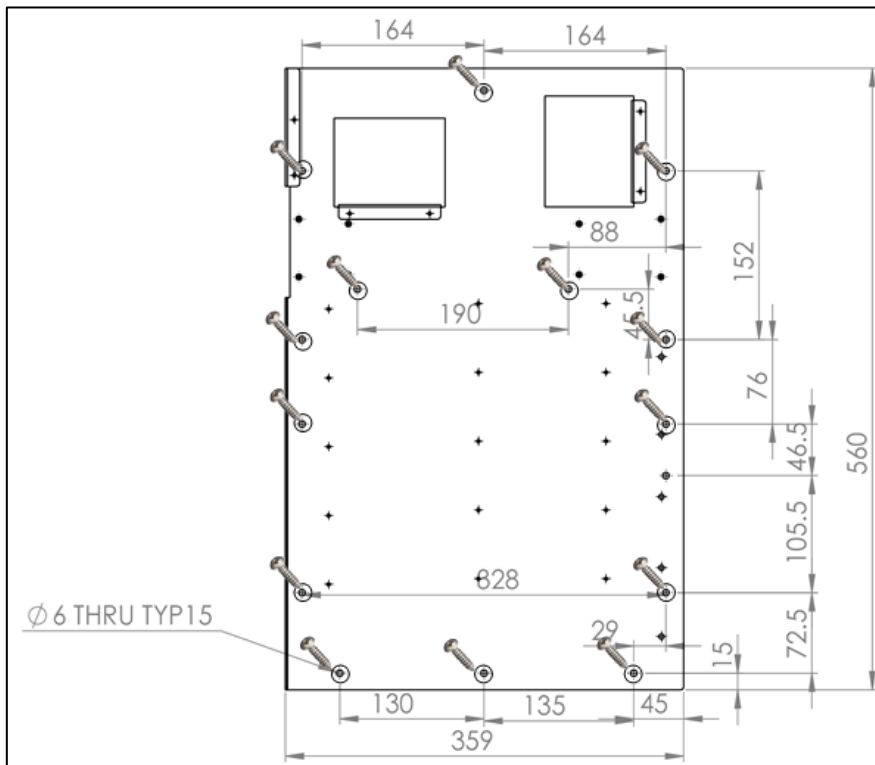

Figure 58: Platinum Pro 50 and Platinum Touch 50 Back Panel Dimensions

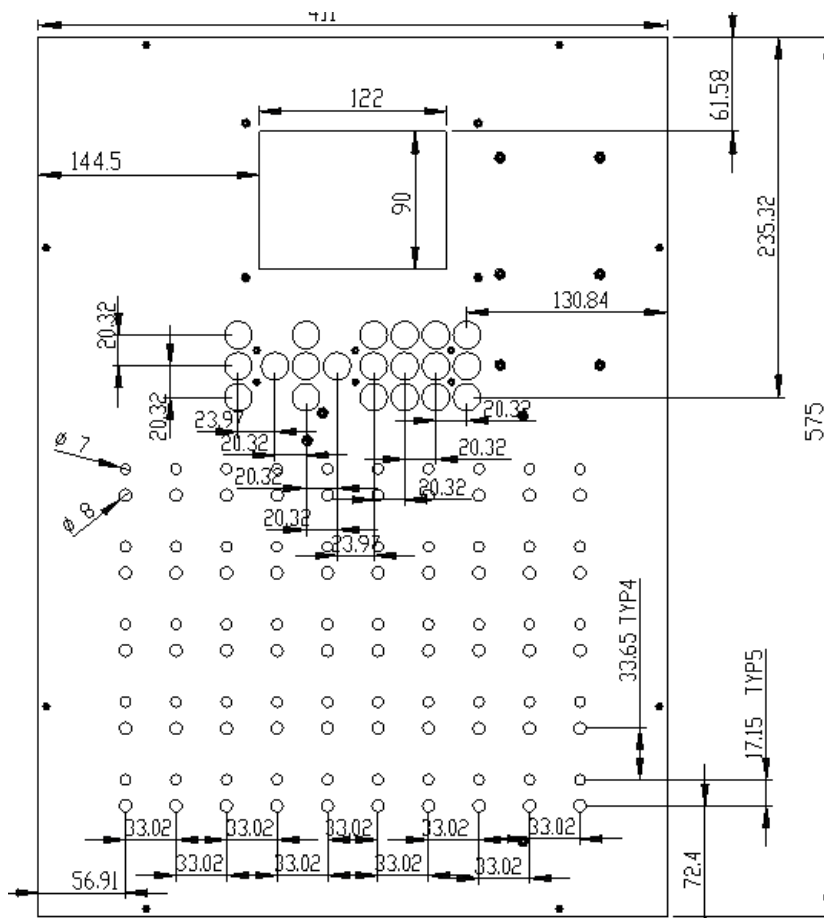

Figure 59: Platinum Pro 50 Front Panel Dimensions

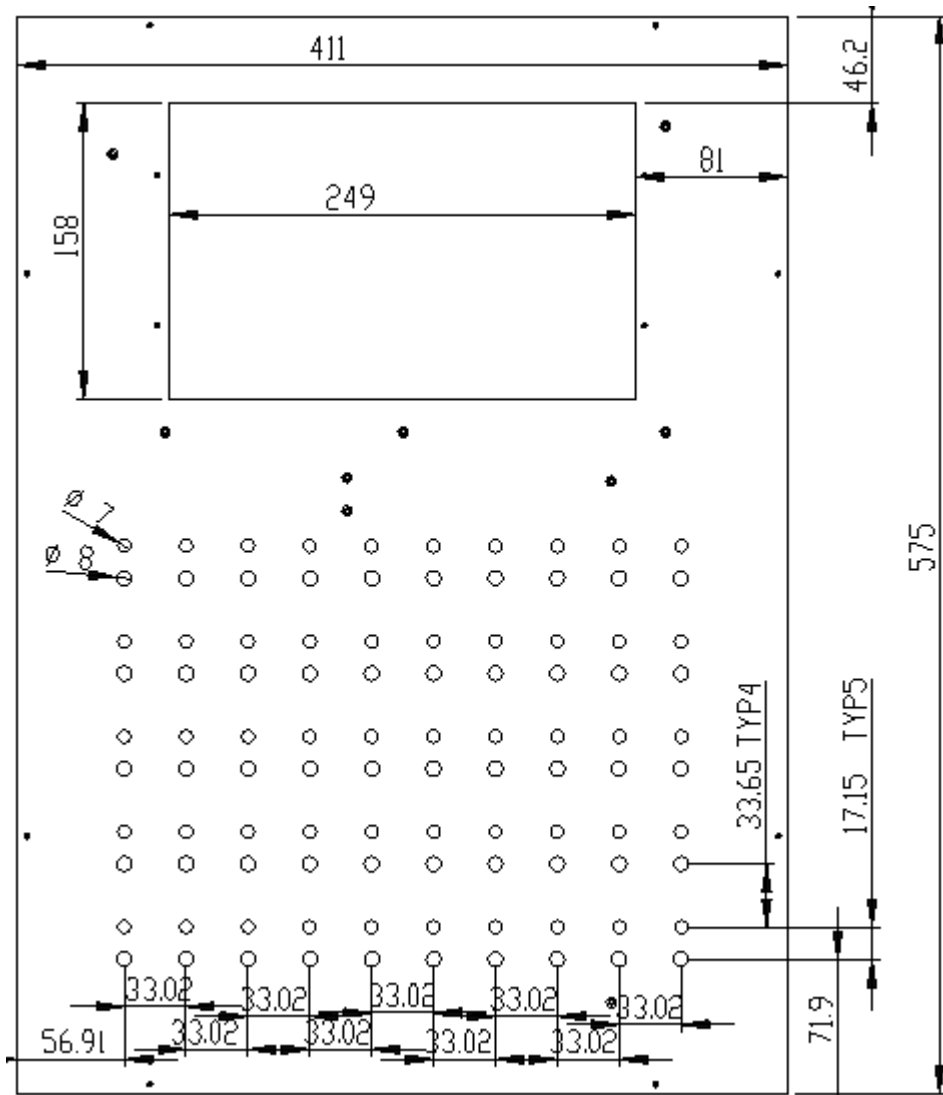

Figure 60: Platinum Touch 50 Front Panel Dimensions

9.4 Mounting the Panels

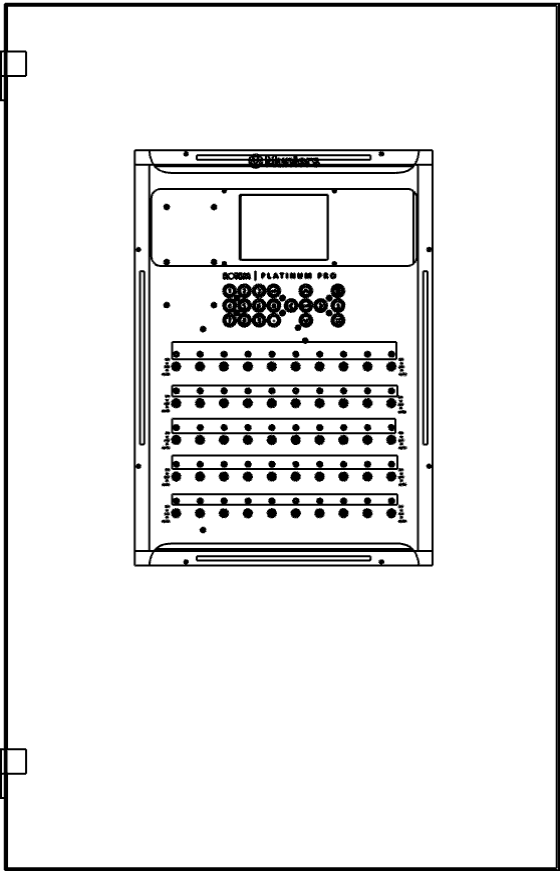

Figure 61: Panel Mount, Closed Closet

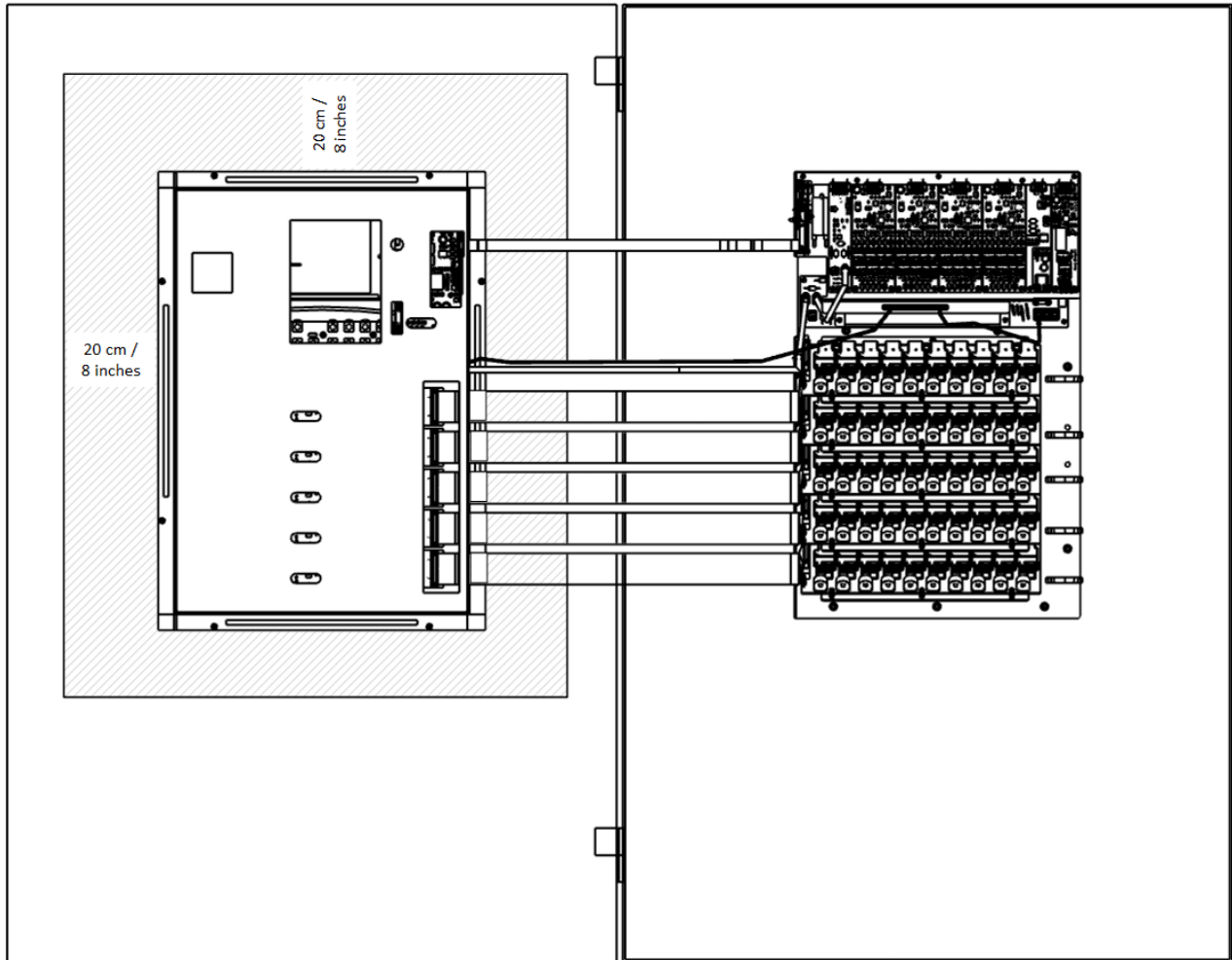

Figure 62: Panel Mount, Open Closet

- Mount the Metal Panel Front Door on the left door (hinge on left side).
- Cut a hole in the door that is 20 millimeters larger than the dimensions shown above.
 - Platinum Pro 30 and Platinum Touch 30 Dimensions: 480 x 380 mm
 - Platinum Pro 50 and Platinum Touch 50 Dimensions: 580 x 380 mm
- Make sure that there is at least 20 cm/8 inches between the relay and I/O metal base plate and any power contactors or other metal equipment.
- Any inverter must be at least five meters away from the controller.
- To prevent signal disruption, do not run sensor wiring via the DIN rails.
- Do not run power wires through the area of the relay and IO metal base plate.

9.5 Connecting the Metal Panels

This section illustrates how to connect the two Metal Panels. The Front Door Panel and Relay Panel come with cables and wiring attached to each panel:

- Front Door Panel: Grounding cable and Internal communication/power cable
- Relay Panel: Flat cables

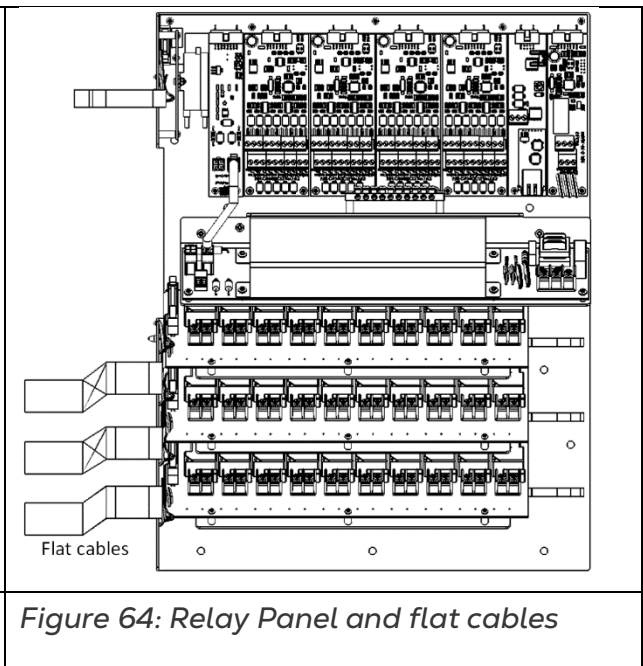
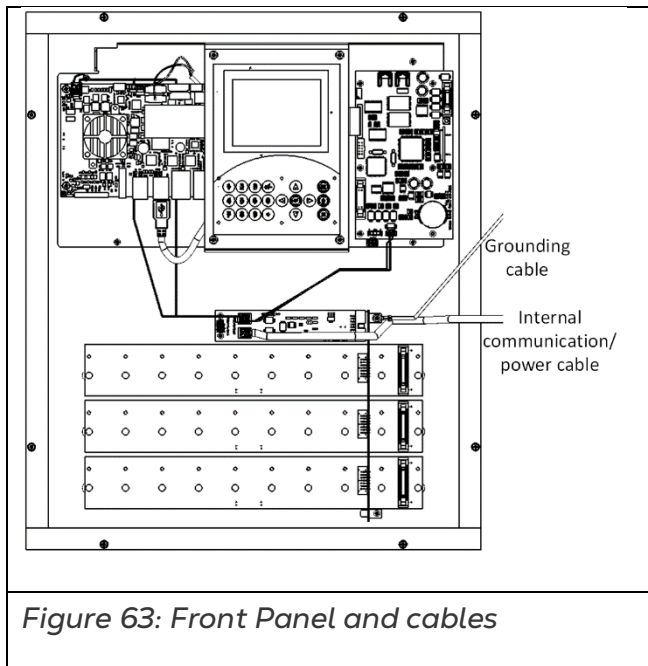

NOTE The procedure is illustrated using a Platinum Touch, 30 Relays. The procedure for connecting the Platinum Pro 30, Platinum Pro 50, and Platinum Touch 50 is exactly the same. However the number of flat cables can differ:

- Platinum Pro 30 Relays: up to four flat cables
- Platinum Pro/Touch 50 relays: up to six flat cables

9.5.1 PRECAUTIONS

- Ensure that the electricity is disconnected before beginning!
- When threading the cables, verify that no high power cables are close to the low power cards (analog input/output and digital input)
- Verify that all connections are properly grounded and shielded as detailed in the manual.

9.5.2 PANEL MOUNT CABLE CONNECTIONS

1. Remove the cover from the Front Door Panel.

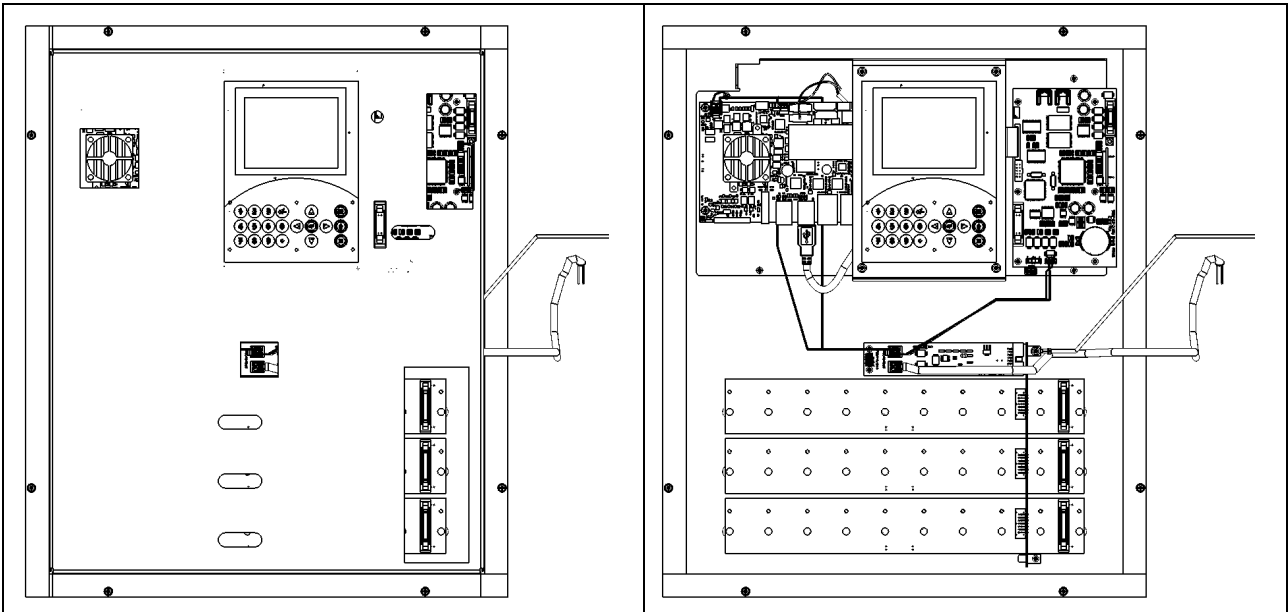

Figure 65: Cover removed

2. Connect the flat cables to the Front Door.

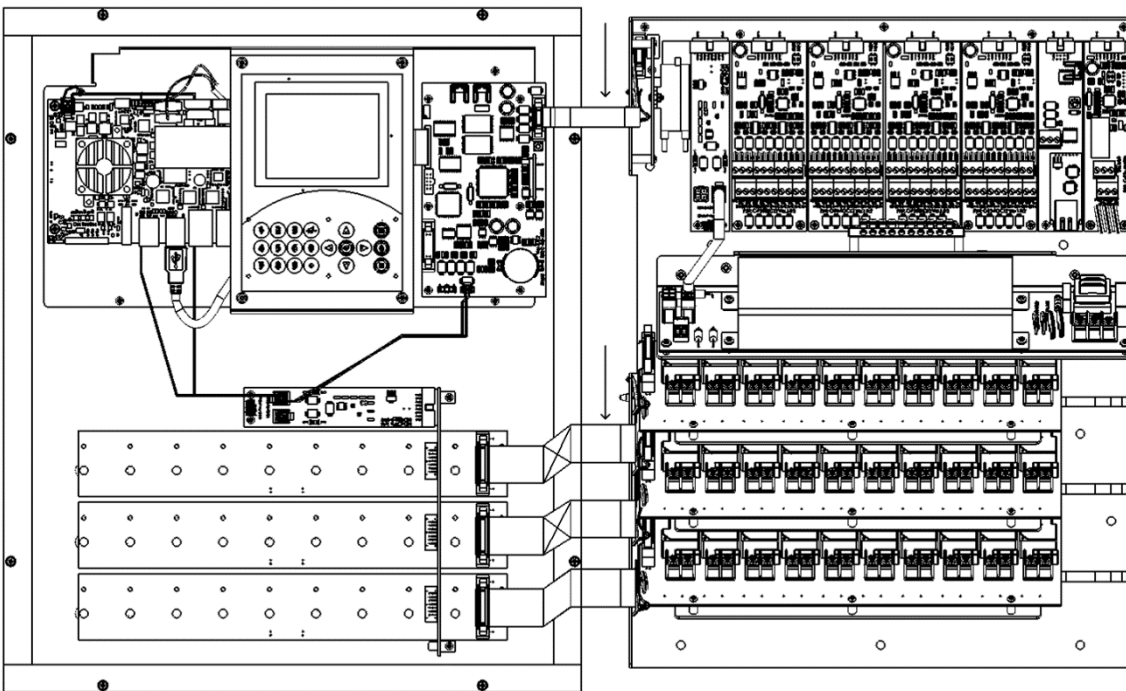

Figure 66: Flat cables connected

3. Connect the grounding cable to the Relay Panel.

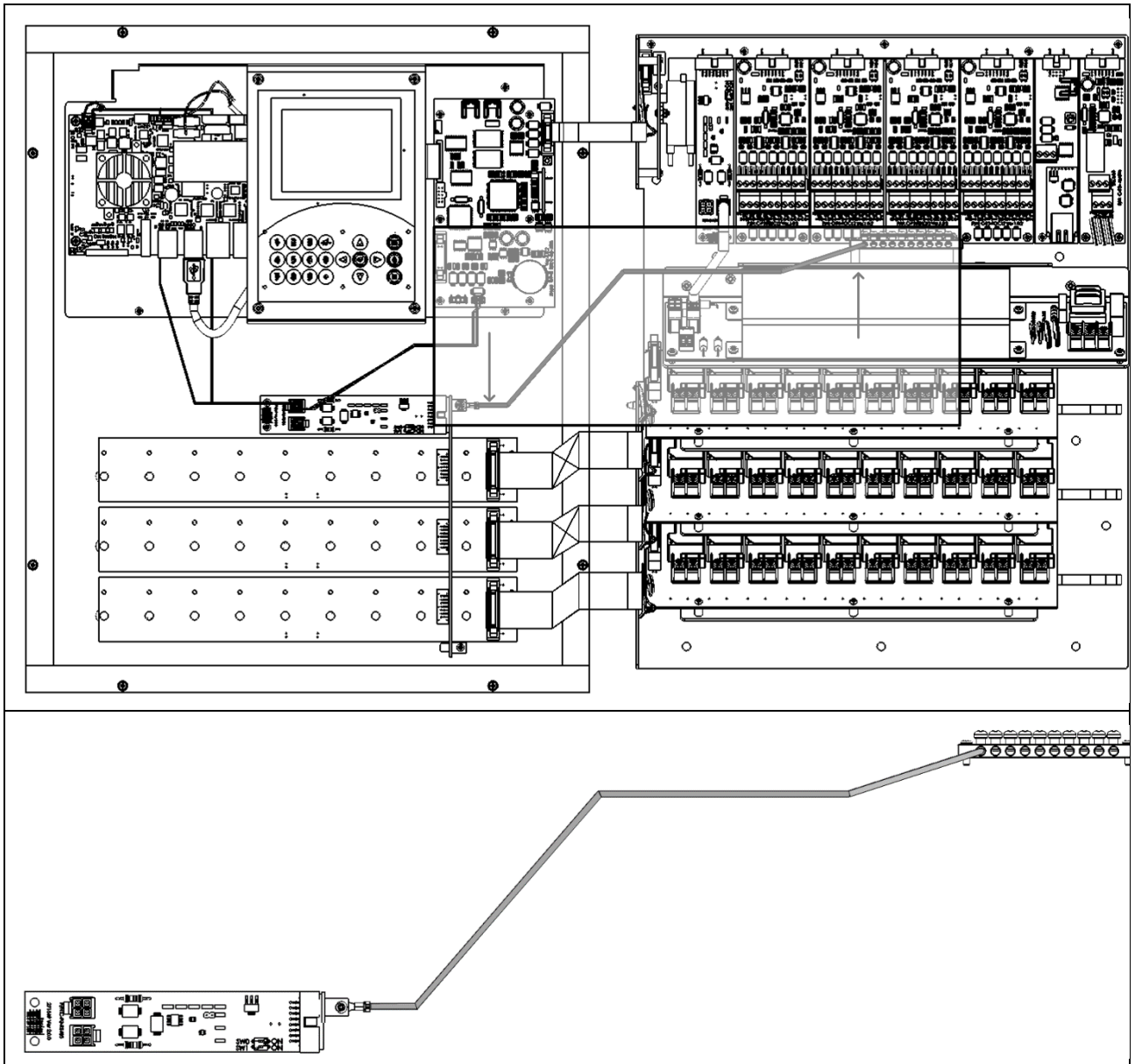

Figure 67: Grounding cable

4. Connect the internal power/communication cable to the Relay Panel.

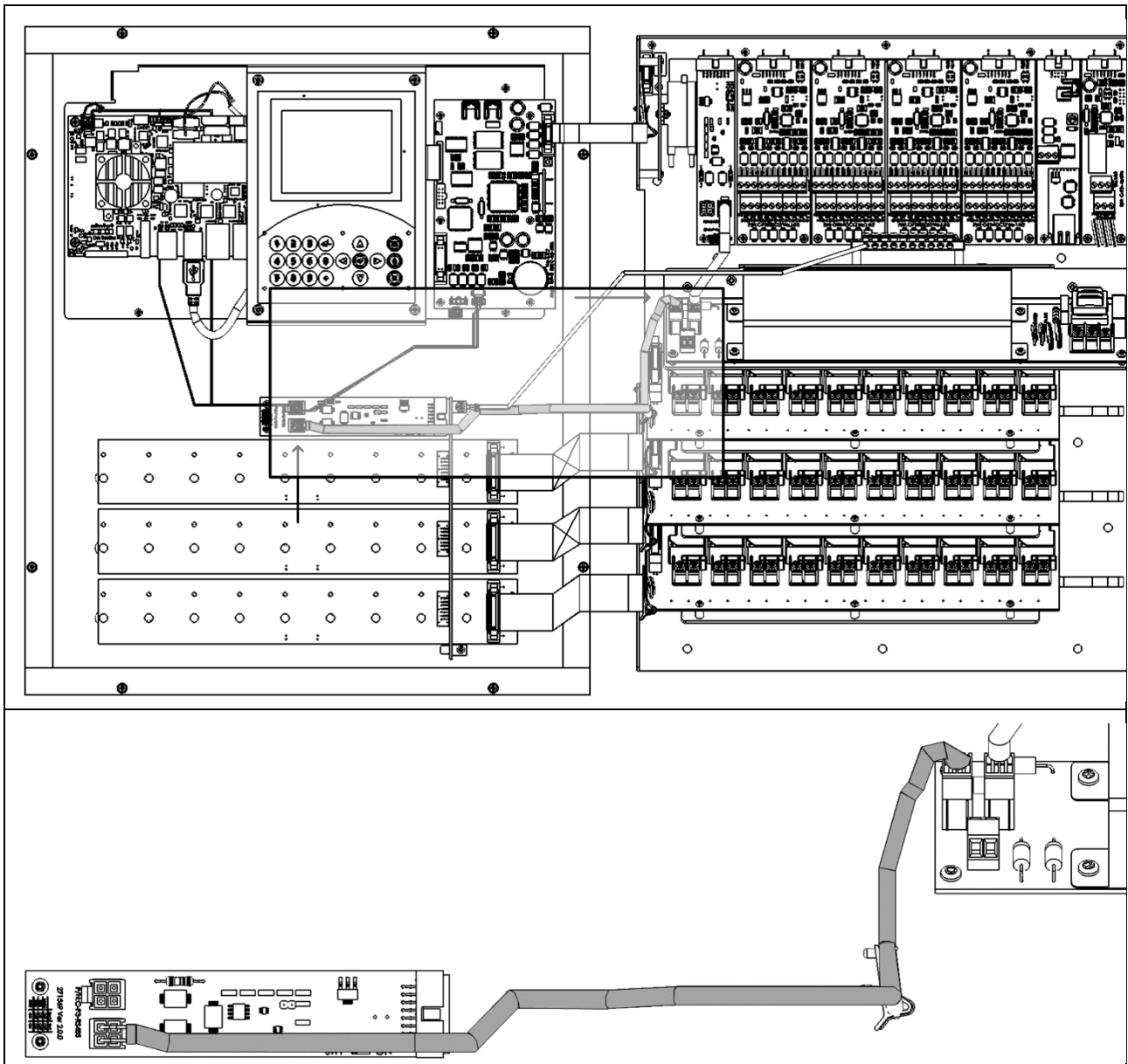

Figure 68: Internal power/communication cable

5. Connect the main power cable to the Relay Panel.

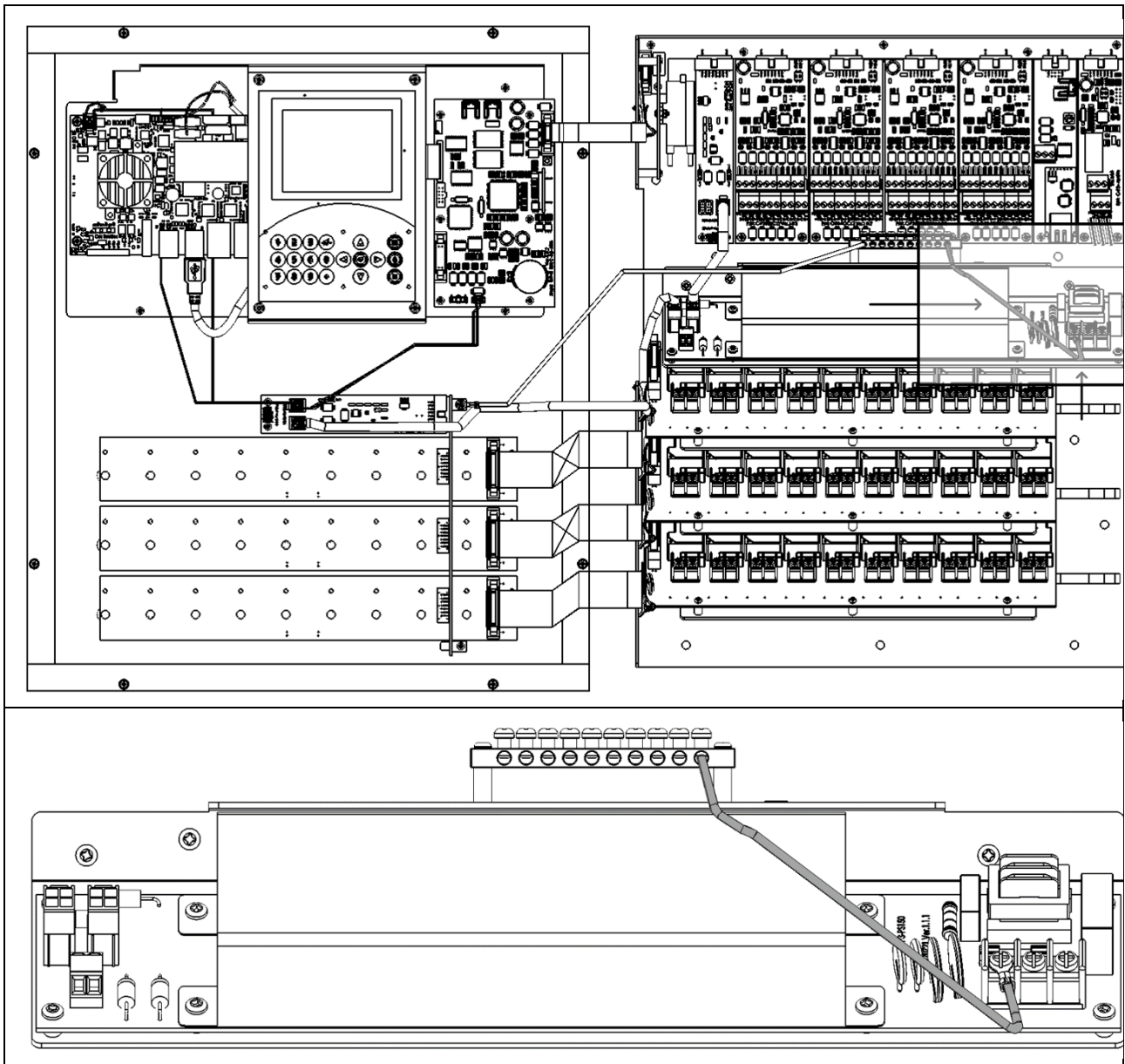

Figure 69: Main power cable

6. Replace the cover.

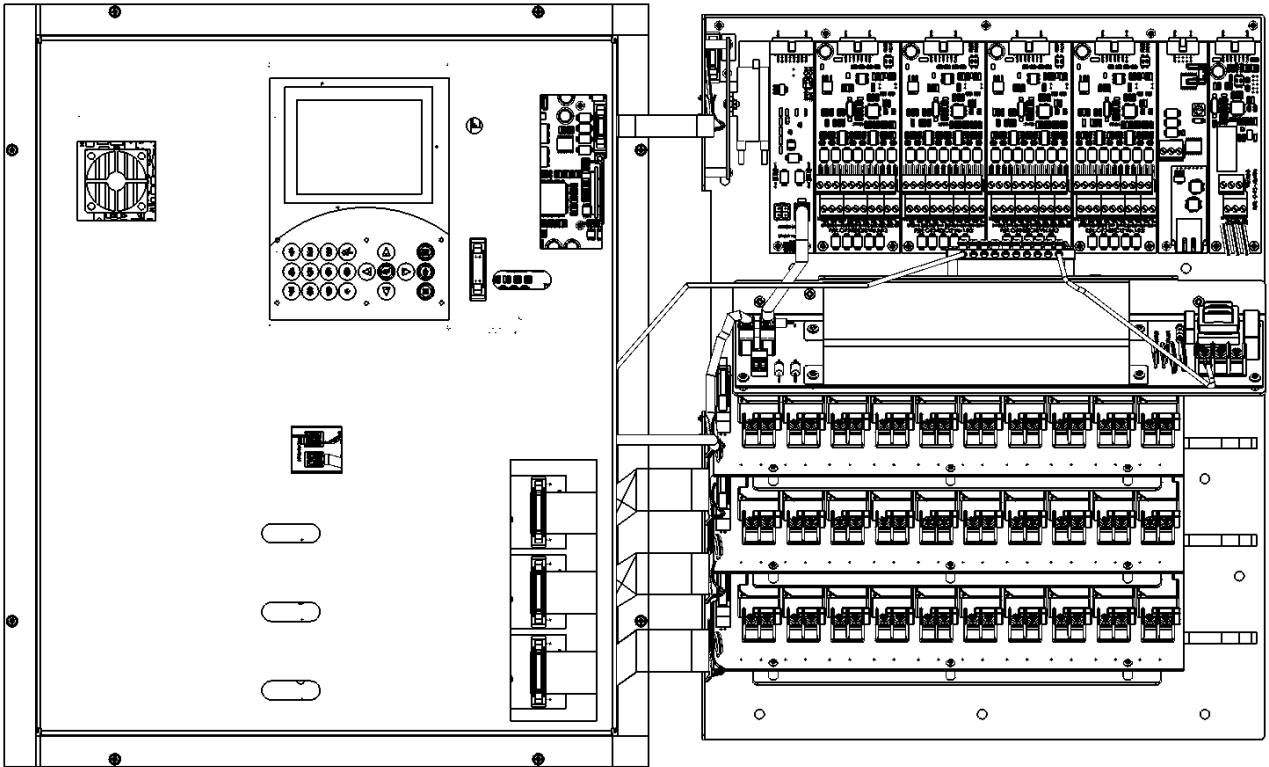

Figure 70: Panel in place

10 Appendix B: One Pro Winch Card Set Replacement

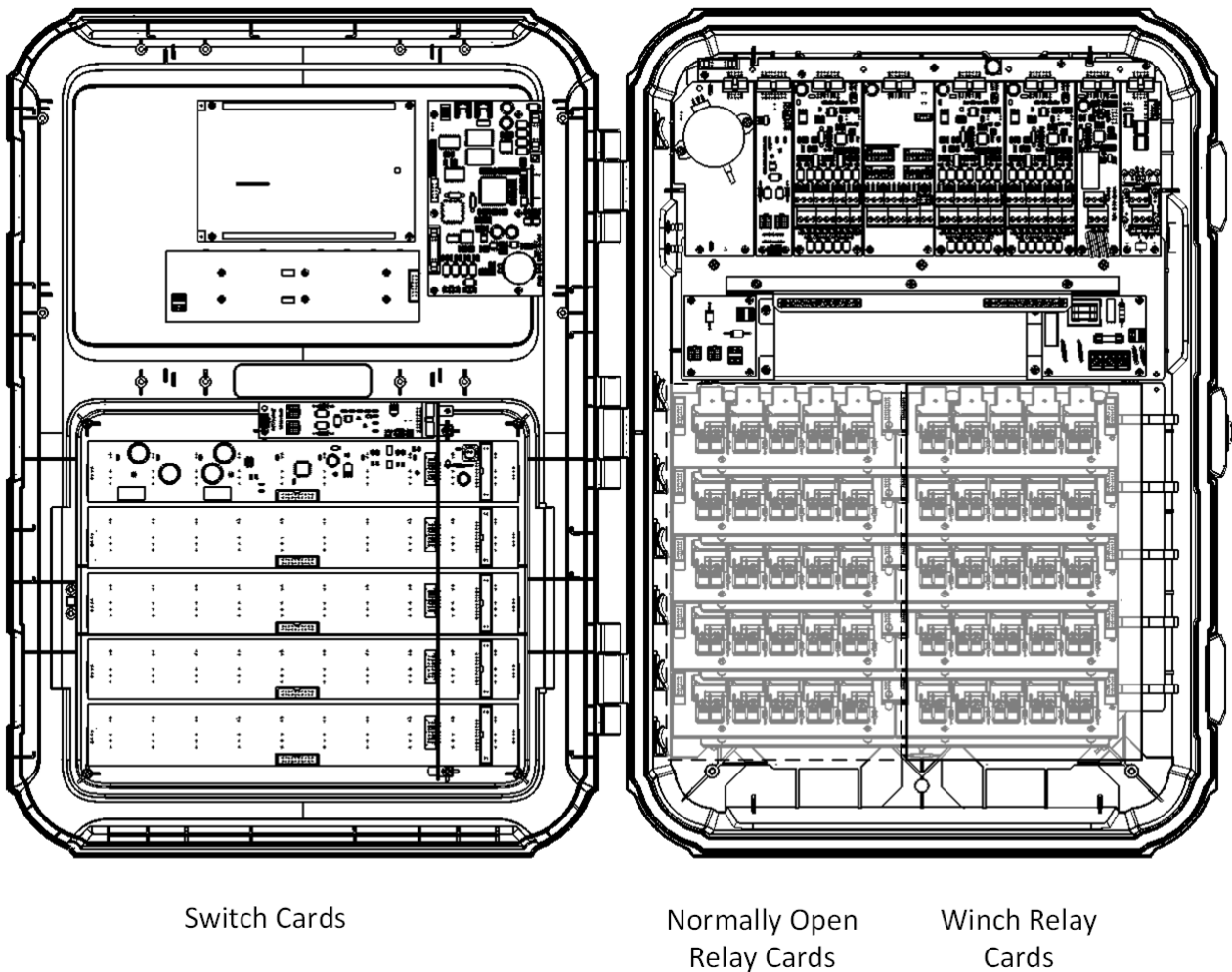

Figure 71: One Pro Cards and Switches

10.1 General

A One Pro Winch Card set (10 relays) consists of the following:

- One Winch Relay Card (five relays)
- One Switch Card
- One Normally Open Relay Card (five relays)
 - The Winch Relay Card is always installed on the right side.
 - The Normally Open Relay card is always installed on the left side.

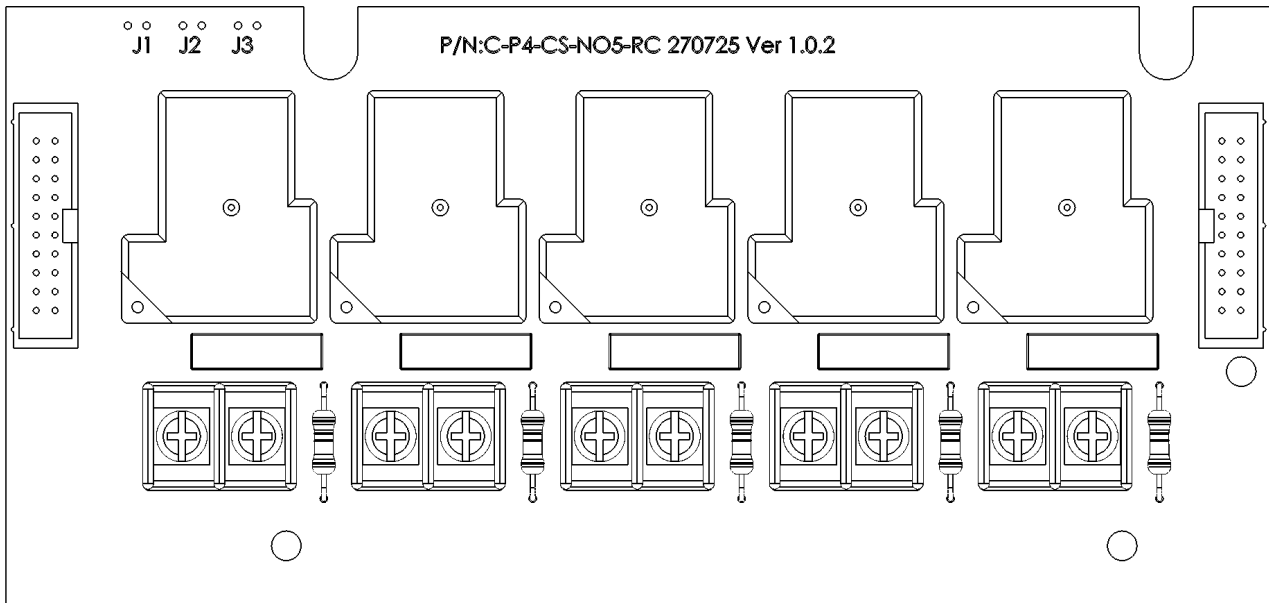

Figure 72: Relay Card showing Jumpers

If there is no jumper installed on the card, the card functions as a Normally Open card.

For the Winch Card set to function as a Winch Card, jumper must be installed properly on the Normally Open Card.

10.2 In Practice

- When a customer orders a One Pro unit that includes a winch card, the Normally Open card comes installed as required, including the requisite jumper. In addition, the card comes in place if a dealer technician assembles a One Pro unit according to the customer's specifications.
- In cases where a someone orders a (replacement) winch card set, the customer/dealer must properly place the jumper in place on the Normally Open (before installing the card) for the winch card to operate properly
 - Solder a jumper to J3.
 - Refer to the following drawing.

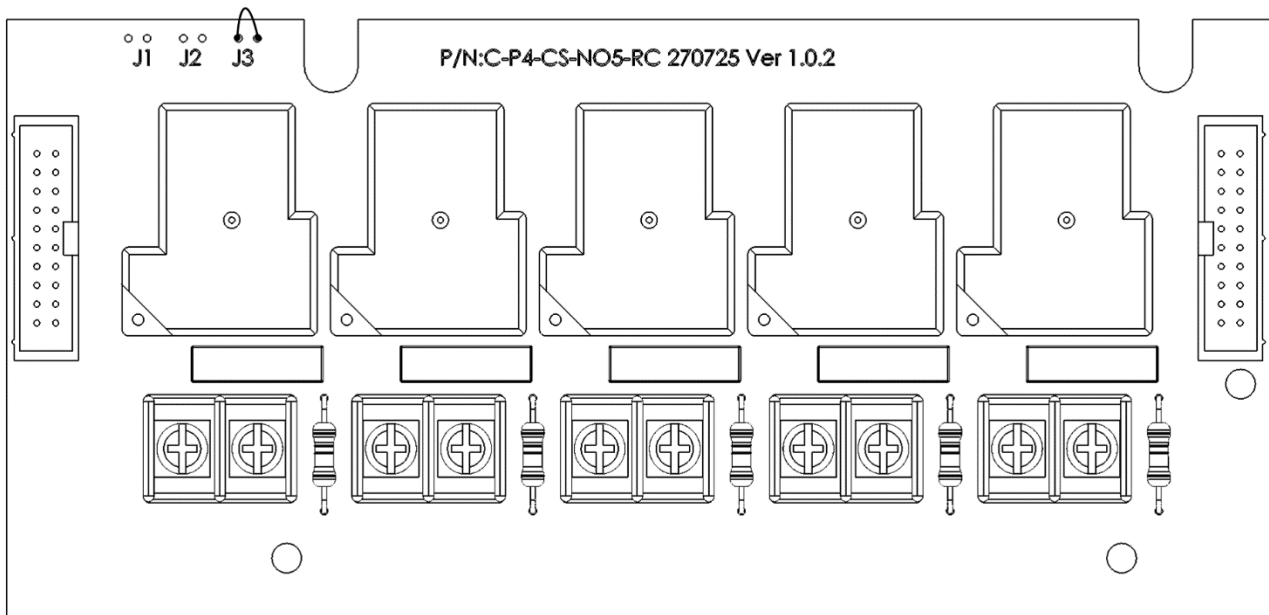

Figure 73: Placing the Jumpers

10.3 Relay Card Layout Considerations

- When installing or replacing Normally Closed cards, all ten relays in any given row must be Normally Closed cards.
- When installing or replacing Normally Open cards, all ten relays in any given row must be set to Normally Open UNLESS the Normally Open Winch Relay Cards are used.

11 Appendix C: Electrical Grounding

CAUTION *Always connect temperature and sensor shields to earth ground. Avoid mixing high voltage wiring with sensor and low voltage wiring. Keep the controller as far as possible from heavy contactor boxes and other sources of electrical interference.*

11.1 Ground Rods

Ground rods are used to efficiently connect the system to earth where current may be dissipated in the soil.

1. Material: Ground rods should be copper clad or galvanized steel.
2. Diameter: Minimum 5/8", preferably 3/4". Generally the larger the rod diameter, the lower it's resistance to current flow.
3. Length: Minimum 2.5 meters (8 feet), preferably 3-meter (10-foot). A longer ground rod will reach a soil with higher moisture content. Moist soil carries current much better than drier soil.
4. Single grounding: It is important that there is only one grounding location where a rod or series of rods are connected to each other using a ground wire.
5. Independent ground rods will increase the risk of current, from a lightning strike for example, being dissipated through one rod and reentering the system through an adjacent rod.
6. Location: Close to the main circuit breaker panel and in moist soil. For example in an area that is usually wet from a drip or a low spot where water drains. Make sure the area is well protected from damage by lawnmowers, tractors, etc.'
7. Rod installation: Drive the rod into the earth until about 10 cm (4 inches) is left above grade. If it is impossible to drive the rod to the proper depth, it is acceptable to lay the rod horizontally, 80 cm (2.5 feet) below grade.

In case the rod is exposed to damage, for example by lawnmowers or tractors it can be installed in a hole, about 20 cm (8 inches) deep so that the rod is about 10 cm under grade and 10 cm above hole level.

NOTE *The National Electric Code (NEC) mandates two ground rods unless you can show less than 10 ohms resistance with one rod.*

11.2 Ground Wire

The ground wire is a large copper wire that connects the main circuit breaker panel to the ground rod.

1. Material: Ground rods should be copper clad or galvanized steel.
2. Diameter: Typically, 16 mm (6-gauge) copper wire is sufficient. If the wire run is greater than 20 feet, 20 mm (4-gauge) wire should be used.
3. Length: Minimum 2.5 meters (8 feet), preferably 3-meter (10-foot). A longer ground rod will reach a soil with higher moisture content. Moist soil carries current much better than drier soil.

The ground wire should be protected from damage by lawnmowers, tractors, etc'. It should be buried minimum 15 cm (6 inches) under grade for protection and enter the house as soon as possible. It is important that the wire not be cut; it should remain continuous.

11.3 Ground Clamps

Ground wires should not be merely wrapped around a ground rod. Ground clamps are used to attach a ground wire to a ground rod. The most common clamp is known as an acorn clamp. Make sure the ground clamps you select are rated for outdoor use. Do not use pipe clamps rated for inside water lines or hose clamps to attach the ground wire.

11.4 What Should Be Grounded?

Any equipment that is or could become energized, even accidentally, should be grounded. Current from lightning, strikes objects in a random fashion. Accounts of lightning strikes reveal scenarios most of us could not predict.

Electric circuits should be wired with a 3-wire conductor consisting of hot, neutral and grounding wires. The grounding wire should be attached cleanly and securely to devices or systems to be grounded. The other end of the grounding wire should be attached to the ground bus on the main panel.

11.5 Lightning Protection

Because of the potential for lightning damage to electronic devices, Munters recommends supplying lightning protection on both the power supply and the communication terminals (if used).

11.5.1 POWER LINE PROTECTION

The RPLP-1 provides lightning protection to the controllers. Refer to the RPLP-1 documentation for detailed wiring instructions. While no lightning protection is perfect, the RPLP-1 significantly enhances the reliability of built-in lightning protection. In addition, Munters recommends using an isolation transformer in front of the RPLP-1 to help block lightning and other transients.

NOTE Common surge protectors provide little additional protection, and may trip unnecessarily.

An isolation transformer preceding the RPLP-1 provides significant additional protection against lightning.

11.5.2 COMMUNICATION LINE PROTECTION

The RCLP-1 provides communication protection for the controller. Refer to the RCLP-1 documentation for detailed wiring instructions. Since outdoor communication lines can receive and conduct powerful electromagnetic pulses into the controllers and cause significant damage, Munters advises using a RCLP-1 prevent damage to the units.

NOTE Common surge protectors provide little additional protection and may trip unnecessarily.

12 Appendix D: Electromagnetic Noise Suppression Circuit

- English
- Circuit de Suppression de Bruit Electromagnetique

12.1 English

NOTE The following section is relevant to One Pro and Platinum Pro units only.

A snubber circuit suppresses electromagnetic interference during relay switching. Each relay on the Relay Cards has a jumper that defines that relay's noise suppression circuit.

In installations when replacing any Relay Card Version 1.02 with Version 1.1.0:

- In installations employing single-phase electricity, to directly driven devices, install the card as is (leave the jumpers in place).
- In installations employing three-phase electricity, through power contactors or relays, remove the jumper from the corresponding relay.

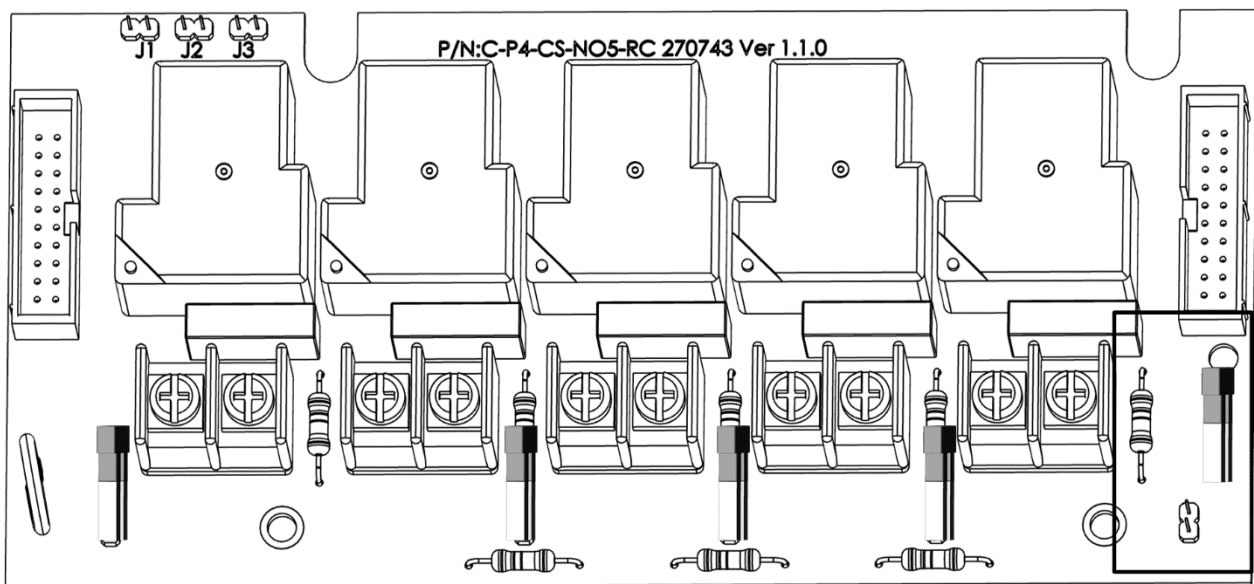

Figure 74: Removing the Jumper

12.2 Circuit de Suppression de Bruit Electromagnetique

NOTE La section suivante concerne uniquement les unités One Pro et Platinum Pro.

Le circuit d'amortissement élimine les interférences électromagnétiques lors de la commutation du relais. Chaque relais sur les cartes de relais possède un cavalier électrique qui définit le circuit de suppression de bruit de ce même relais.

Dans lors d'un remplacement d'une carte relais Version 1.02 avec la Version 1.1.0 :

- Dans les installations qui utilise une électricité monophasée, sur des appareils directement pilotés, installez la carte telle quelle (laissez les cavaliers électriques à leur place).
- Dans les installations qui utilise une électricité triphasée, par des contacteurs ou des relais de puissance, retirez le cavalier électrique du relais correspondant.

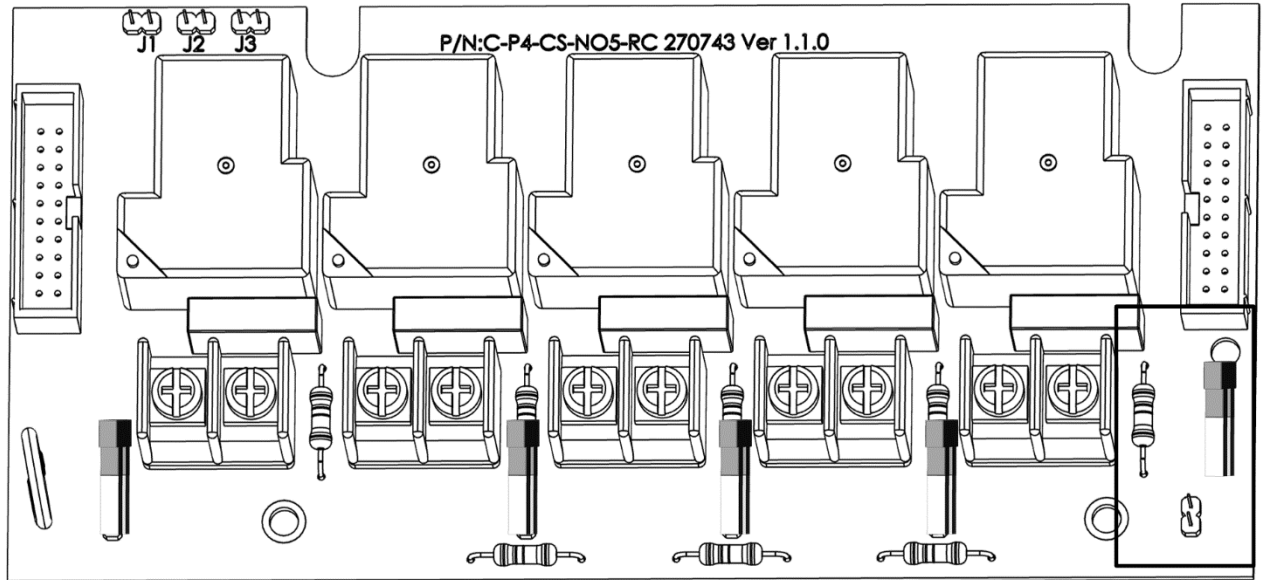

Figure 75: Retrait du cavalier électrique

13 Warranty

Warranty and technical assistance

Munters products are designed and built to provide reliable and satisfactory performance but cannot be guaranteed free of faults; although they are reliable products they can develop unforeseeable defects and the user must take this into account and arrange adequate emergency or alarm systems if failure to operate could cause damage to the articles for which the Munters plant was required: if this is not done, the user is fully responsible for the damage which they could suffer.

Munters extends this limited warranty to the first purchaser and guarantees its products to be free from defects originating in manufacture or materials for one year from the date of delivery, provided that suitable transport, storage, installation and maintenance terms are complied with. The warranty does not apply if the products have been repaired without express authorisation from Munters, or repaired in such a way that, in Munters' judgement, their performance and reliability have been impaired, or incorrectly installed, or subjected to improper use. The user accepts total responsibility for incorrect use of the products.

The warranty on products from outside suppliers fitted to One Pro/Platinum Pro, (for example sensors, inputs, cables, etc.) is limited to the conditions stated by the supplier: all claims must be made in writing within eight days of the discovery of the defect and within 12 months of the delivery of the defective product. Munters has thirty days from the date of receipt in which to take action, and has the right to examine the product at the customer's premises or at its own plant (carriage cost to be borne by the customer).

Munters at its sole discretion has the option of replacing or repairing, free of charge, products which it considers defective, and will arrange for their despatch back to the customer carriage paid. In the case of faulty parts of small commercial value which are widely available (such as bolts, etc.) for urgent despatch, where the cost of carriage would exceed the value of the parts, Munters may authorise the customer exclusively to purchase the replacement parts locally; Munters will reimburse the value of the product at its cost price.

Munters will not be liable for costs incurred in demounting the defective part, or the time required to travel to site and the associated travel costs. No agent, employee or dealer is authorised to give any further guarantees or to accept any other liability on Munters' behalf in connection with other Munters products, except in writing with the signature of one of the Company's Managers.

WARNING! *In the interests of improving the quality of its products and services, Munters reserves the right at any time and without prior notice to alter the specifications in this manual.*

The liability of the manufacturer Munters ceases in the event of:

- dismantling the safety devices;
- use of unauthorised materials;
- inadequate maintenance;
- use of non-original spare parts and accessories.

Barring specific contractual terms, the following are directly at the user's expense:

- preparing installation sites;
- providing an electricity supply (including the protective equipotential bonding (PE) conductor, in accordance with CEI EN 60204-1, paragraph 8.2), for correctly connecting the equipment to the mains electricity supply;
- providing ancillary services appropriate to the requirements of the plant on the basis of the information supplied with regard to installation;
- tools and consumables required for fitting and installation;
- lubricants necessary for commissioning and maintenance.

It is mandatory to purchase and use only original spare parts or those recommended by the manufacturer.

Dismantling and assembly must be performed by qualified technicians and according to the manufacturer's instructions.

The use of non-original spare parts or incorrect assembly exonerates the manufacturer from all liability.

Requests for technical assistance and spare parts can be made directly to the nearest [Munters office](#).

