



# Relay Expansion Box for Platinum Pro and Rotem One



Platinum Pro Expansion



Rotem Expansion

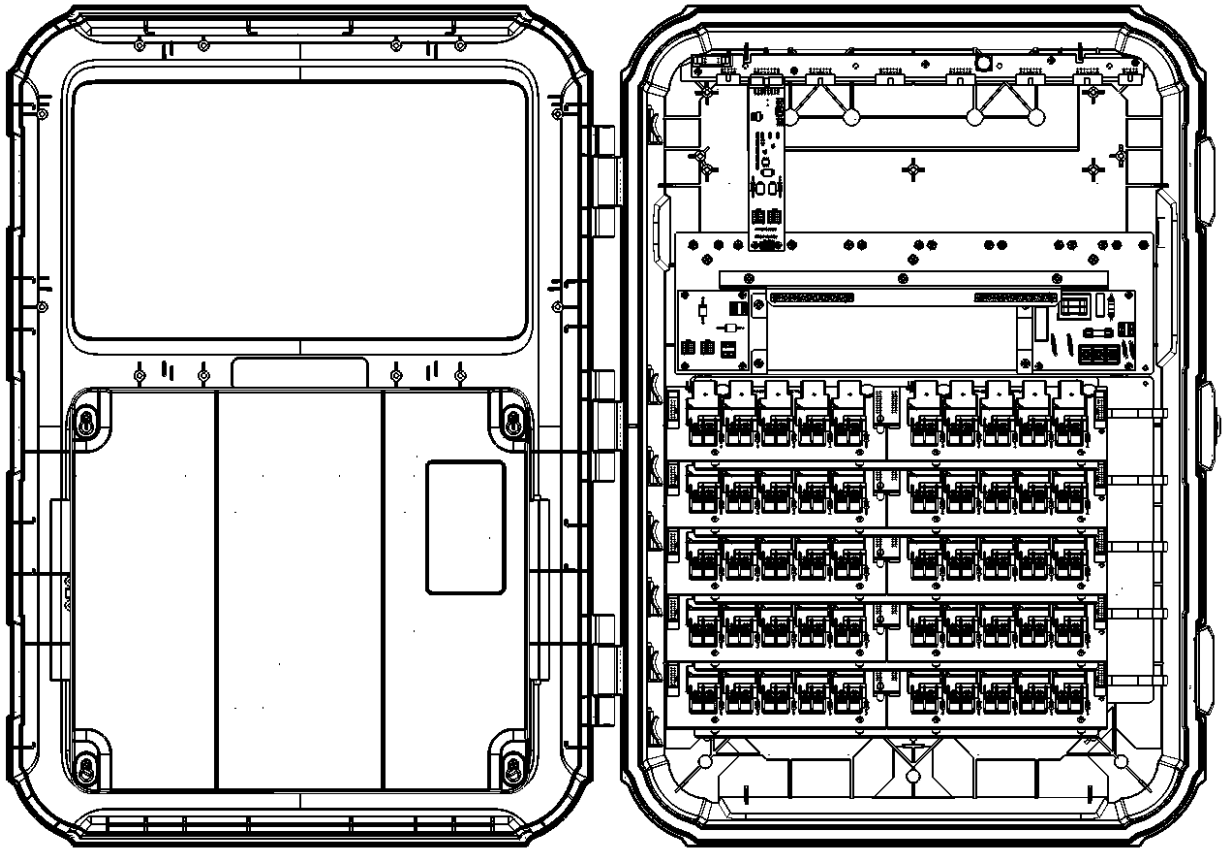

Figure 1: Rotem Expansion

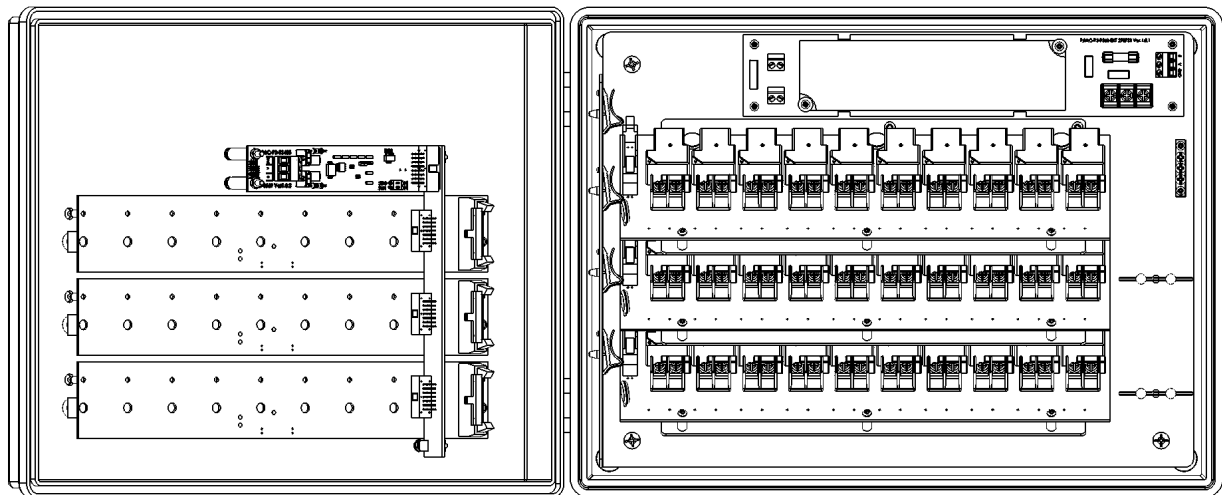

Figure 2: Platinum Pro Expansion

*NOTE* The Rotem Expansion supports analog input, analog output, and digital input cards. Platinum Pro Expansion does not support these cards.

1. Wire the Platinum Pro PP-485ISO-485/PP232ISO-485 card to the Platinum Expansion RS-485 card.

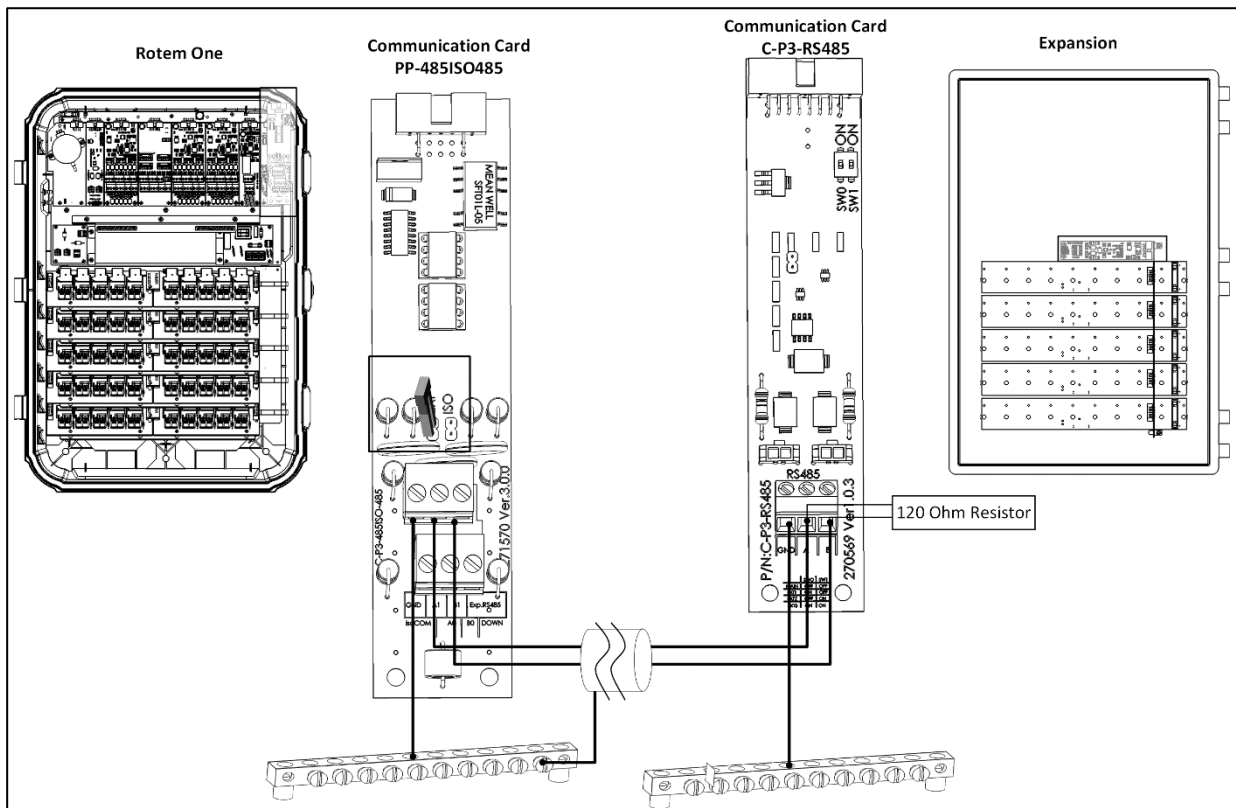

Figure 3: Platinum Pro to Rotem Expansion Wiring

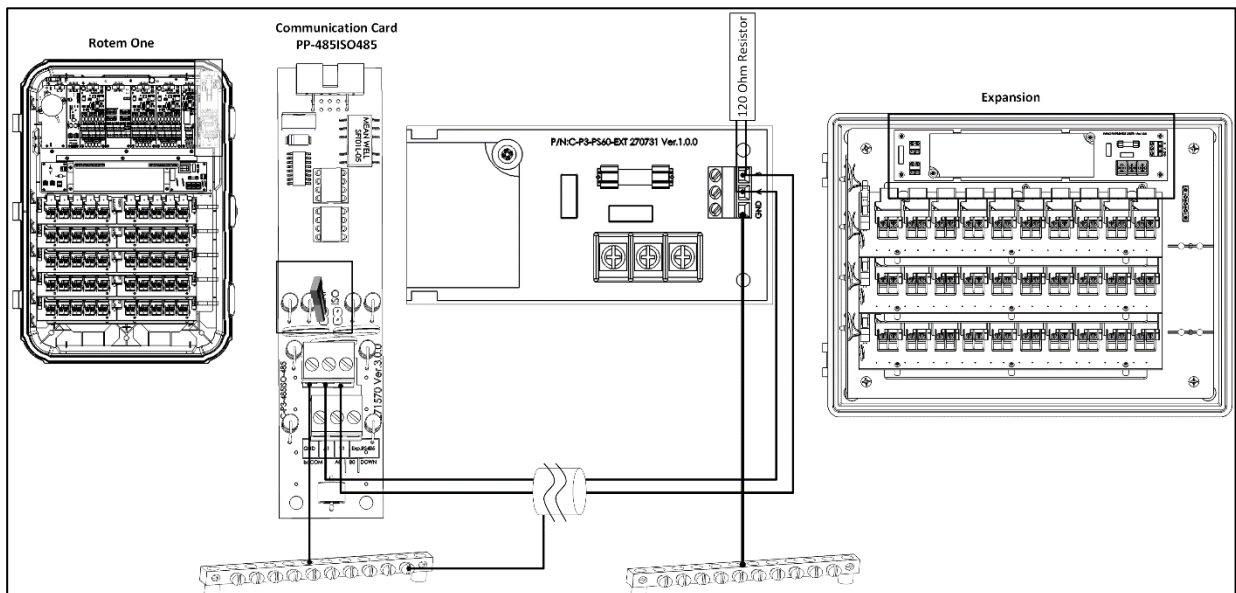

Figure 4: Platinum Pro to Platinum Expansion Wiring

2. To ensure proper termination, place a:

- A terminator on the EXP jumpers on the Rotem One/Platinum Pro communication card (if the Platinum Pro is located at the end of a daisy chain)
- A 120 ohm resistor on the Expansion communication card

3. The Controller and Expansion RS-485 cards each have dip switches that define the unit's function and address.

- Define the Controller's RS-485 card dip switches as Main.
- Define the Expansion units dip switches as required.

Table 1: Dip Switch Settings

	SW0 Position	SW1 Position
Main	Off	Off
Expansion 1	Off	On

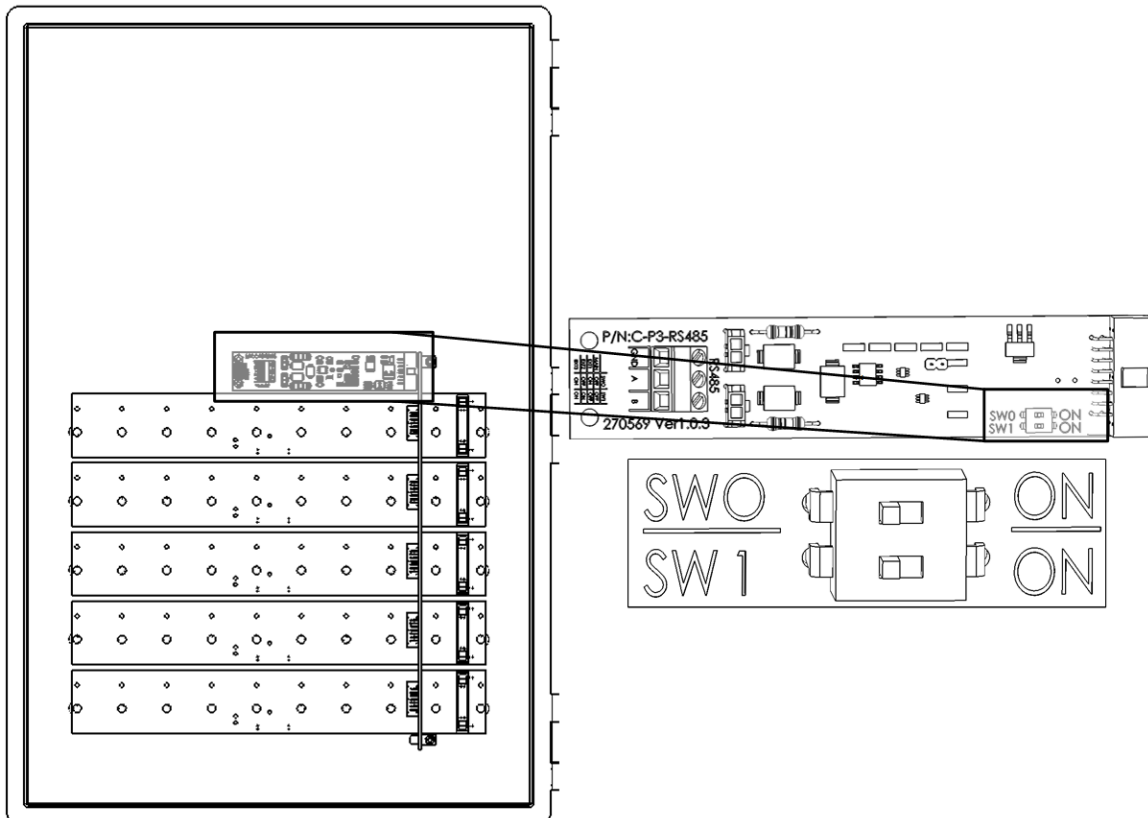
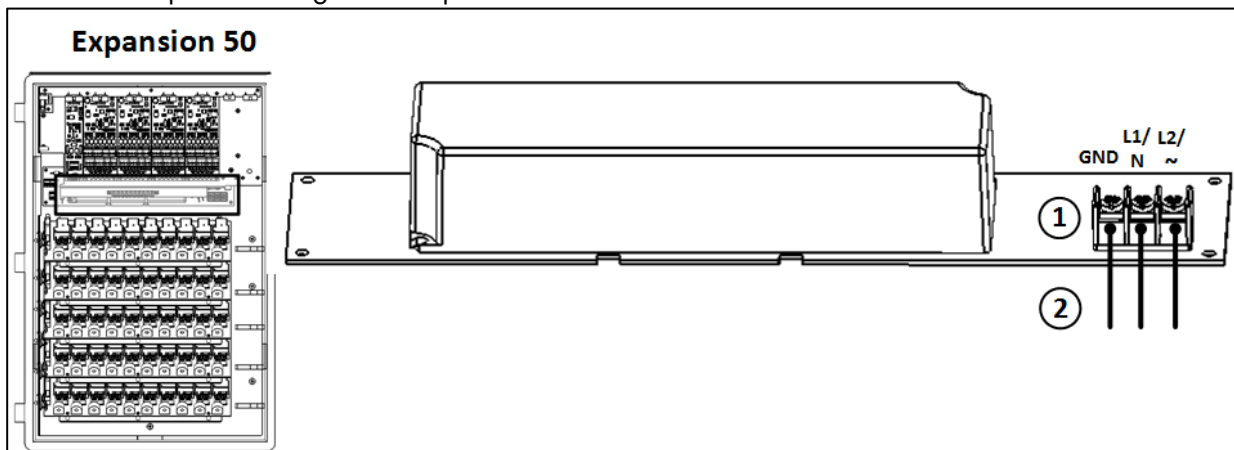

Figure 5: Expansion Address Dip Switches

4. Connect the relays (and analog/digital devices if relevant) as required. Refer to the Platinum Pro/Rotem One Installation manual for details.
5. Attach the power wiring to the Expansion as shown below.



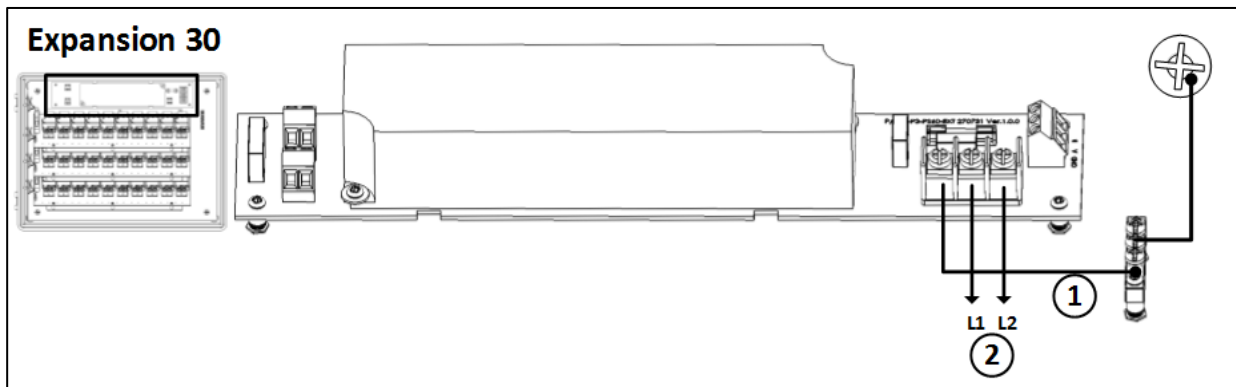

Figure 7: Platinum Expansion Power Wiring

- Connect the power supply wires to the appropriate ports (1).
- 230 VAC, 50/60 Hz; USA: L1, L2; ROW line, neutral (2)