

Heater options

Burner Options

Filter, silencer, manual handle with locking device or control bracket and linkage (CB&L), high and low fire switches.

Gauge Package

Gas pressure gauges for: pilot before regulator (inlet pressure to gas train), pilot after regulator, main after regulator, and main before burner. Includes needle valves and piping.

Gas Train and Controls options are available with components especially selected for automotive standards; consult factory for details.

FM Gas Train

One main manual shut-off valve with locking device, one main safety shut-off valve, main pressure regulator, high and low gas pressure switches, pilot manual shut-off valve, pilot safety shut-off valve, pilot pressure regulator, flame safeguard (flame rod or UV scanner), ignition transformer, leak test valves.

Indirect-fired gas heater data

OTH Model	Burner Model	Max Gas Input (MBh)	Gas Inlet Pressure ("W.C.)	Motor HP	Motor Amps for 115/1/60	Motor Amps for 460/3/60
0500	OP 412M (OP LE 10)	600	4.5 (8.1)	½ (1)	9.8 (N/A)	1.1 (2.1)
0800	OP 415 (OP LE 10)	950	4.2 (8.1)	⅓ (1)	7.2 (N/A)	0.7 (2.1)
1250	OP 425 (OP LE 15)	1500	3.6 (8.5)	¾ (1½)	13.8 (20)	1.6 (3.0)
1750	OP 432M (OP LE 25)	2100	4.9 (8.4)	¾ (2)	13.8 (24)	1.6 (3.4)
2500	OP 445M (OP LE 30)	3000	4.5 (8.8)	1 (3)	16 (34)	2.1 (4.8)
3500	OP 470M (OP LE 45)	4200	5.2 (9.2)	2 (5)	N/A (N/A)	3.4 (7.6)

Note: Values in parenthesis are for optional OP-LE Burner.

XL GAP Gas Train

FM Gas Train components plus: second safety shut-off valve, vent valve, additional leak test valve, second pilot manual shut-off valve, additional vent piping and couplings.

Control Package

Honeywell® combustion controller with flame safeguard amplifier, purge timers, temperature controller, burner controller, actuator, high and low fire switches for burner, control transformer, control bracket and linkage, electrical panel and all wiring.

Munters is the leader in designing, engineering, and manufacturing heat exchangers, indirect gas heaters, packaged make-up air systems, and dehumidification systems.

Superior Engineering

Munters' innovation extends from product development to the industry's most respected design and engineering staff. Munters designs and builds its products according to the strictest quality and safety standards, using the best in materials, components, and workmanship.

High Temperature Heat Exchangers

Munters' patented designs and exclusive features employ cutting-edge technologies that no other manufacturer can offer. For decades Munters has

provided customers with extensive expertise designing high-temperature industrial heat exchangers that perform under demanding industrial conditions with temperatures up to 1,800°F.

Product Testing

Munters utilizes modern testing instruments and procedures to ensure the highest quality product. All units are stringently tested for cross-contamination and structural integrity.

Research & Development

As part of Munters dedication to continuous improvement and best practices, the Product Development team continuously evaluates the performance of new construction materials in increasingly challenging environments and investigates new methods of manufacturing. Munters is committed to technological advances and is highly adaptive to customers' changing needs.

Australia Phone +61 2 8843 1580, serviceair@munters.com.au Austria Phone +43 1 6164298-0, service.dh@munters.at Belgium & Luxembourg Phone +32 (0) 15 28 56 11, info@muntersbelgium.be Brazil Phone +55 41 3317 5050, munters.com.br Canada Phone +1 905 858 5894, dhinfo@munters.com China Phone +86 10 8041 8000, serviceair@munters.cn Czech Republic Phone +420 544 211 434, servicecz@munters.de Denmark Phone +45 4495 3355, service.dh@munters.dk Finland Phone +358 40 186 3074, service.dh@munters.fi France Phone +33 1 3411 5757, service.dh@munters.fr Germany Phone +49 40 87 96 90-0, service.dh@munters.de India Phone +91 20 6681 8900, serviceair@munters.in Italy Phone +39 0183 521 377, service.dh@munters.it Japan Phone +91 3 5970 0021, serviceair@munters.jp Korea +82 2 761 8701, serviceair@munters.co.kr Mexico Phone +52 722 270 4029, servicedhmx@munters.com Netherlands Phone +31 172 43 32 31, service@munters.nl Poland Phone +48 58 305 35 17, service.dh@munters.pl Singapore Phone +65 6744 6828, serviceair@munters.com.sg South Africa Phone +27 11 971 9700, info@munters.co.za Spain & Portugal Phone +34 91 640 09 02, service.dh@munters.es Sweden & Norway Phone +46 8 626 6300, service.dh@munters.se Switzerland Phone +41 52 3438886, service.dh@munters.ch Thailand Phone +66 2 6422 6703, serviceair@munters.com.sg Turkey Phone +90 216 548 1444, serviceair@munters.com.tr UAE +971 4881 3026, middle.east@munters.com United Kingdom & Ireland Phone +44 1480 432243, service.dh@munters.co.uk USA Phone +1 800 843 5360, dhinfo@munters.com Vietnam Phone +84 8 3825 6838, vietnam@muntersasia.com



Munters Corporation

Tel: (800) 843-5360 E-mail: dhinfo@munters.com
www.munters.com

VariMax® OTH Indirect-fired Gas Heaters

Features

- Efficiencies up to 88%
- Indirect gas heat
- All-welded stainless steel heat exchanger
- Gas train and controls available
- Complete packages

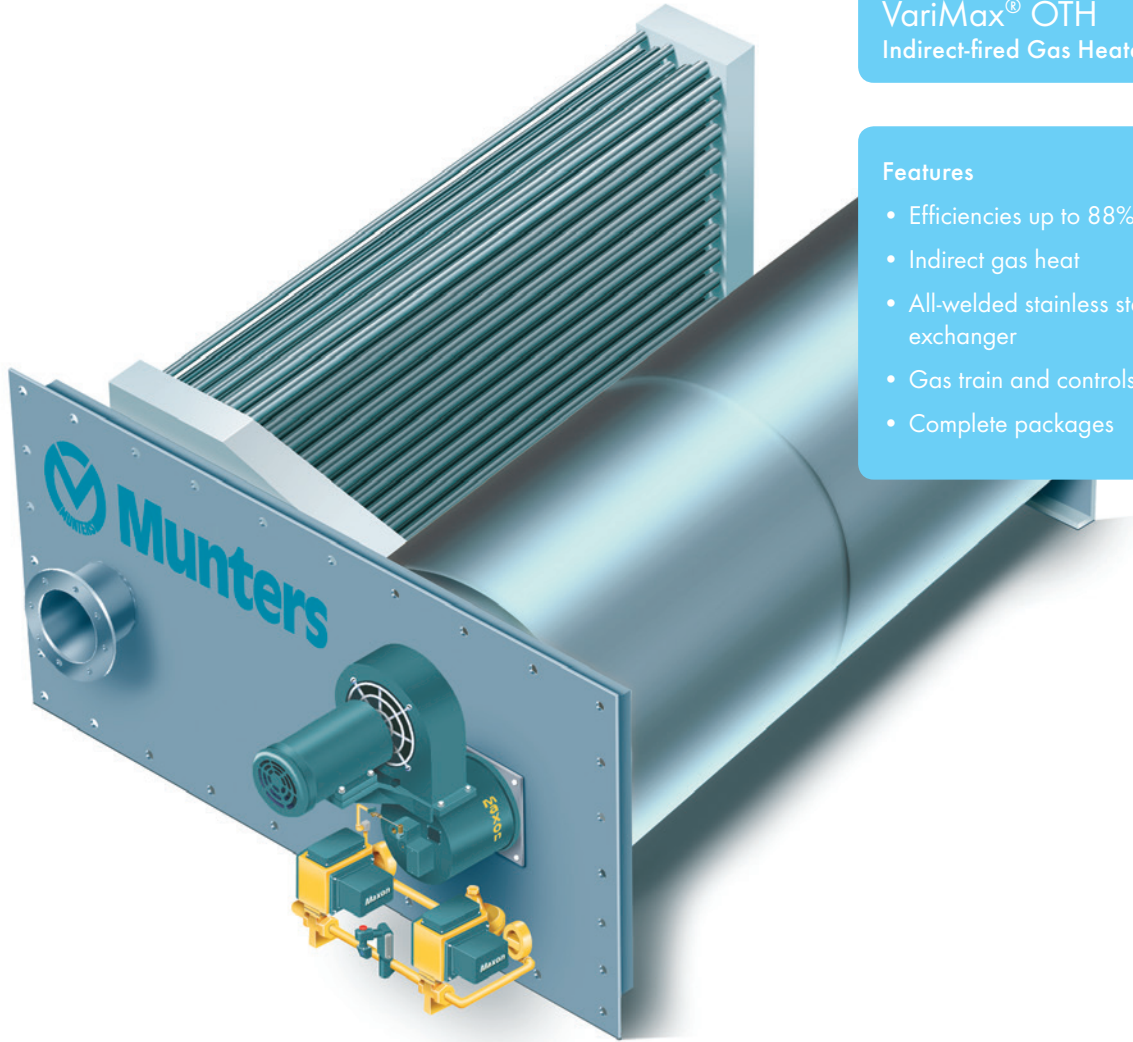

VariMax® OTH – Indirect-fired Gas Heaters

The VariMax® Once-Through Heater (OTH) is a high-efficiency, industrial, indirect-fired gas heater used to heat process air streams without contaminating the air with the products of combustion. The OTH is particularly useful for recirculating ovens, make-up air applications in cold environments and industrial processes with moderate temperature rises.

The counterflow configuration, four-pass design, and optimized secondary tubular heat exchanger, result in efficiencies up to 88%. The heater uses a Maxon® industrial gas burner for clean, reliable combustion. Standard OTH heat exchangers are constructed of heavy-duty stainless steel for strength, durability, and corrosion resistance. Units are available with FM or XL GAP certified gas trains and complete heater controls.

Munters can also provide complete heating packages, including filters, dampers, fans, and duct sections or separate housings.



Standard VariMax OTH

Description

The OTHs are available in six sizes from 500 to 3,500 MBH, with a minimum 3:1 turndown ratio (exact turndown depends on condensing conditions in the heat exchanger), and are capable of handling airflows from 2,000 to 65,000 scfm. The maximum outlet temperature is 600°F and the maximum temperature rise is 150°F. Efficiencies are in the 70% to 88% range, depending on the flow volume, inlet temperature, and firing rate.

Design features

The VariMax OTH features a drum and tube heat exchanger with a four-pass, counterflow design to optimize efficiency. The drum, or firing chamber, is constructed of at least 12 gauge 316L stainless steel for long life under high temperatures. The rest of the heat exchanger is composed of 304L or 316L stainless steel, depending on design temperatures, to provide exceptional durability and resistance to heat and corrosion. Munters is the leader in the design and manufacture of air-to-air tubular heat exchangers and this expertise has been utilized to create a highly efficient secondary tubular heat exchanger. The all welded construction, leak tested for every unit, ensures separation of the products of combustion from the process air stream.

Heat exchangers are "free floating," to allow for thermal expansion, and mounted either to a 1/4" plate or in a pre-fabricated duct section. The flue gas duct can be attached to the unit via a collared or flanged exhaust connection.

The OTH incorporates a Maxon OvenPak® gas burner, a reliable burner with many years of service. The burner features a cast iron body, integral combustion air blower and gas control valve, and low turndown ratio. Burners can be mounted with combustion filters, control linkages, and either flame rods or UV scanners. Emissions can be determined via a sampling port that feeds directly off the combustion chamber.

Dimensional data

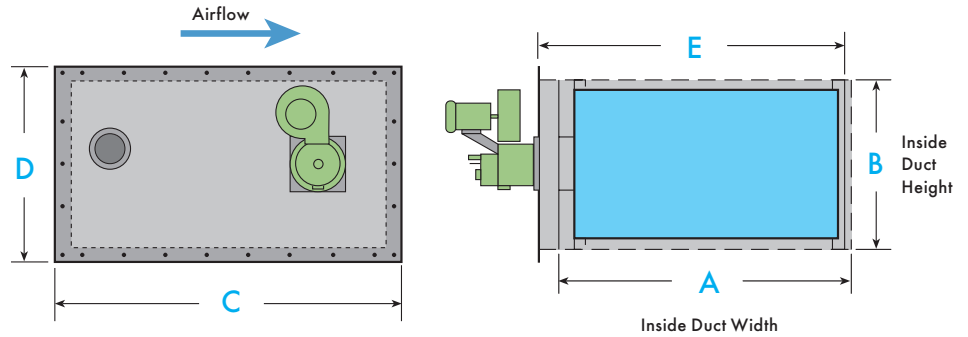

Dimension (inches)

Dimension	Model					
	OTH - 0500	OTH - 0800	OTH - 1250	OTH - 1750	OTH - 2500	OTH - 3500
A	44.50	53.00	59.79	80.50	103.50	128.50
B	27.00	32.00	46.50	49.00	56.00	66.50
C	53.00	65.50	86.00	86.00	102.00	118.50
D	32.00	37.00	51.50	54.00	61.00	71.50
E	47.96	56.25	62.75	83.50	106.21	130.75
Weight	600 lbs.	800 lbs.	1,100 lbs.	1,350 lbs.	2,000 lbs.	3,610 lbs.

Note: Standard thickness of insulated plug is 4". Consult factory for other thickness. Units can be mirrored for flow from right to left. These dimensions are for reference only and are subject to change without notice. Consult factory for certified drawings. Weight does not include burner or shipping frame.

Nominal performance at 70°F inlet temperature

Model	Input MBH	Output MBH	Min scfm	Max scfm	Process Air Temperature Rise (°F)				
					50	80	100	125	150
					scfm				
0500	590	500	2,000	9,500	9,260	5,790	4,630	3,700	3,090
0800	940	800	3,000	15,000	14,800	9,260	7,410	5,930	4,940
1250	1,470	1,250	4,800	24,000	23,150	14,470	11,570	9,260	7,720
1750	2,060	1,750	7,200	33,000	32,400	20,250	16,200	12,960	10,800
2500	2,940	2,500	10,200	47,000	46,300	28,900	23,150	18,520	15,430
3500	4,120	3,500	14,400	65,000	64,800	40,500	32,400	25,930	21,600

*Units cannot be operated at maximum gas input with minimum scfm.

Configurations

The OTH can handle airflows from 2,000 to 65,000 scfm and produce air temperature rises from 20°F to 150°F*, with a maximum outlet temperature of 600°F. The heaters may be placed in series or in parallel as long as the temperature restrictions are not exceeded. Heaters can also be coupled with dampers to provide variable volume systems.

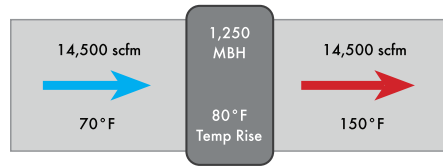

Single

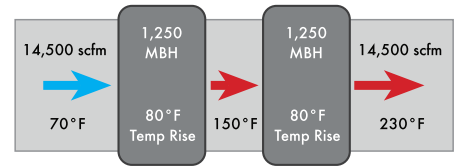

Series

Options

The OTH can be supplied with a gas train, in either FM or XL GAP configurations, and a complete controls package. It is also available in a mirrored design for flow from right to left and in a pre-packaged, insulated duct section.

As a leader in custom air-handling systems, Munters can also provide complete heating systems including fans, dampers, filters, and controls. Consult factory for details.

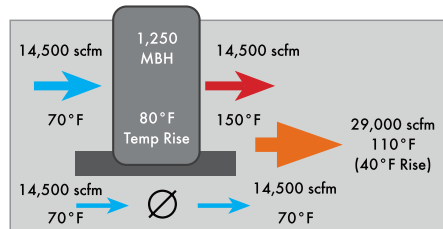

Variable Volume

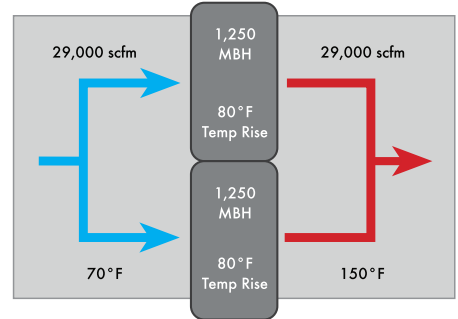

Parallel

See factory regarding distances between heaters.

*If temperature rises greater than 150°F are required, consult Munters for information regarding the VariMax® IFRG (Indirect-Fired Recirculating Gas) heater.

Optional: Complete packaged units

Munters can provide complete packaged units incorporating the OTH, as shown below.

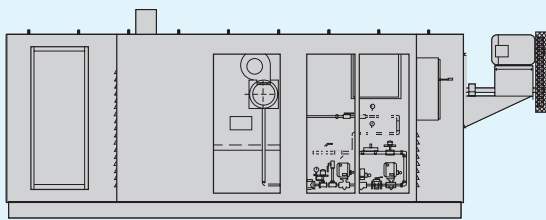

Side View

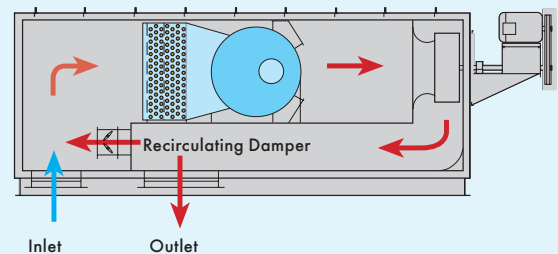

Side Section

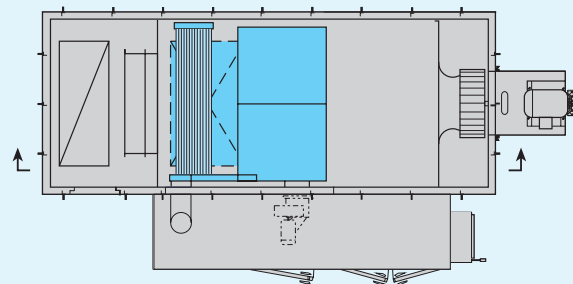

Plan View