

User Manual

Platinum Pro/ Rotem Pro



Platinum Pro/Rotem Pro

Climate Controllers (Standard Mode)

Ag/MIS/ImGB-2490-01/18 Rev 1.8
P/N: 117684



Platinum Pro/Rotem Pro

Standard Mode User Manual

Revision: N1.8 of 08/2023

Product Software: Version 6.24

This manual for use and maintenance is an integral part of the apparatus together with the attached technical documentation.

This document is destined for the user of the apparatus; it may not be reproduced in whole or in part, committed to computer memory as a file or delivered to third parties without the prior authorization of the assembler of the system.

Munters reserves the right to effect modifications to the apparatus in accordance with technical and legal developments.

1	INTRODUCTION.....	10
1.1	Disclaimer.....	10
1.2	Introduction	10
1.3	Notes	10
2	INTRODUCTION TO STANDARD MODE.....	11
2.1	Front Panel.....	12
2.2	Keypad.....	12
2.3	Hot Screens.....	13
2.4	Standard Display	14
2.5	Main Menu Icons.....	16
2.6	Rotem Pro LEDs.....	16
2.7	Selecting the Mode	17
2.8	Software Version Screen.....	17
3	CONTROL MENU	18
3.1	Temperature Curve	18
3.1.1	Temperature Curve Main Screen.....	18
3.1.2	Temperature Curve Help Set.....	19
3.2	Humidity Treatment	20
3.2.1	Humidity Main Screen.....	20
3.2.2	Humidity Treatment Help Set Definitions.....	21
3.3	Minimum Vent Timer.....	21
3.3.1	How Does Minimum Ventilation Work?.....	21
3.3.2	Setting up Minimum Ventilation.....	23
3.3.3	Ramping Timer Help Set.....	23
3.3.4	Additional Details.....	24
3.4	Timer Settings.....	24
3.5	Static Pressure.....	25
3.5.1	Static Pressure Main Screen	25
3.5.2	Disabling Static Pressure.....	26
3.5.3	Static Pressure Help Set Definitions.....	26
3.6	Control Mode.....	27
3.6.1	Control Mode Main Screen.....	27
3.6.2	Catching Mode	27
3.7	System Parameters	28
3.8	CO2 Treatment	28
3.8.1	CO2 Main Screen	28
3.8.2	CO2 Treatment Help Set Definitions.....	29
3.9	Ammonia Treatment	30
3.9.1	Ammonia Main Screen.....	30

3.9.2	Ammonia Treatment Help Set Definitions	31
3.10	Water Dosing	31
3.10.1	Dosing Pump Main Screen	31
3.10.2	Dosing Pump Settings Screen.....	32
3.10.3	Dosing Hot Screen.....	32
4	DEVICE MENU	33
4.1	Temp & Timer Setting.....	33
4.1.1	Temp & Timer Main Screen.....	33
4.1.2	Temp & Timer Settings Help Set.....	34
4.2	Cool Pad.....	35
4.2.1	Cool Pad (Standard)	35
4.2.1.1	Cool Pad Main Screen	35
4.2.1.2	Cool Pad Help Set Definitions	36
4.2.2	bCool Pad (Ramping).....	36
4.2.2.1	Introduction to Cool Pad Ramping	37
4.2.2.2	Cool Pad Main Screen	37
4.2.2.3	Cool Pad Help Set Definitions	38
4.3	Foggers	39
4.3.1	Foggers Main Screen.....	39
4.3.2	Foggers Help Set Definitions	40
4.4	Water & Feed	40
4.4.1	Water & Feed Main Screen	40
4.4.2	Water and Feed Help Set Definitions.....	41
4.5	light	42
4.5.1	Light Main Screen.....	42
4.5.2	Light Help Set Definitions	43
4.5.3	Light Measurement Control.....	45
4.6	Extra Systems	45
4.7	Variable Speed Fan Setting	46
4.7.1	Variable Speed Fan Main Screen.....	46
4.7.2	Variable Speed Fan Help Set Definitions.....	47
4.8	Water on Demand	48
4.8.1	Relay Control	48
4.8.2	Sensor Control.....	49
4.8.3	Water on Demand Help Set Definitions.....	49
4.9	Feed Scale Program	50
4.9.1	Feed Scale Help Set Definitions	51
4.9.2	Operating Mode.....	52
4.9.3	Feed Scale Hot Screen	52
4.9.4	Feed Scale Hot Screen	53
4.9.5	Feed Scale Functionality in Two Houses	54

5	MANAGEMENT MENU	57
5.1	Bird Inventory	57
5.2	Feed Inventory	58
5.2.1	Feed Inventory Main Screen	58
5.2.2	Feed Inventory Help Set Definitions.....	58
5.3	Time & Date	59
5.4	Growth Day & Flock	59
5.5	Alarm Setting.....	59
5.5.1	Alarm Settings Main Screen	60
5.5.2	Alarm Setting Help Set Definitions.....	61
5.5.3	Prioritizing Alarms.....	64
5.6	Alarm Reset	64
5.7	Fail Safe Setting.....	65
5.8	Password.....	65
5.9	Relay Current.....	66
5.10	RDT-5 / Temperature Curve.....	67
5.10.1	RDT-5 Digital Alarm	68
5.10.2	Saving and Loading RDT-5 Tables	68
5.10.3	RDT-5 / Temperature Curve Set Definitions	68
5.10.4	RDT-5, Version 6.22.....	69
6	SCALE MENU	70
6.1	Scale Layout.....	70
6.1.1	Scale Layout Main Screen.....	70
6.1.2	Scale Layout Set Definitions.....	71
6.2	Bird Scale Setting	71
6.2.1	Bird Scale Setting Screen	71
6.2.2	Bird Scale Setting Set Definitions.....	72
6.3	Silo Setting.....	72
6.4	Bird Weight.....	73
6.4.1	Bird Weight Main Screen	73
6.4.2	Bird Weight Help Set Definitions.....	73
6.5	Gender Based Weighing	74
6.5.1	Auto or Auto Turkey Curve	75
6.5.2	Customized/Industrial Standard Curves.....	75
6.6	History.....	76
6.7	Feed Conversion.....	76
6.8	Test.....	76
6.9	Calibration.....	77
6.9.1	Scale Calibration.....	77
6.9.2	Silo Calibration	77
6.10	Silo / Auger Layout	78

7	HISTORY MENU	79
7.1	Temperature	79
7.2	Humidity	79
7.3	CO2	79
7.4	Water	79
7.5	Feed	80
7.6	Mortality	80
7.7	Heaters	80
7.8	Radiant Heaters	80
7.9	Alarms	80
7.10	Table of Events	81
7.11	Power Consumption	81
7.12	Ammonia History	81
7.13	Dosing History	81
8	TEST MENU	82
8.1	Switches & Relays	82
8.2	Alarm	83
8.3	Analog Sensors	83
8.4	Digital Sensors	84
8.5	Analog Output	84
8.6	Static Pressure	84
8.7	Communication	85
8.8	Hardware Checklist	85
9	SERVICE MENU	86
9.1	Temperature Calibration	86
9.2	Humidity Calibration	87
9.3	CO2 Sensor	87
9.4	Static Pressure Calibration	88
9.5	Light Sensor Calibration	89
9.6	Feed Calibration	90
9.7	Water Calibration	90
9.8	Potentiometer Calibration	90
9.9	Nipple Flushing	91
9.9.1	Nipple Flushing Help Set Definitions	92
9.9.2	Nipple Flushing by Temperature	92
9.10	Feeders & Drinkers	93
9.10.1	Feeders & Drinkers Main Screen	93
9.10.2	Feeders & Drinkers Help Set Definitions	94
9.11	Save Settings	94
9.11.1	Saving to a Data Plug	95

9.11.2	Saving to an SD Card.....	95
9.12	Load Settings.....	96
9.12.1	Loading from a Data Plug.....	96
9.12.2	Loading from an SD Card	96
9.12.3	Load Settings Report	97
9.13	Current Sense Relay Calibration	98
9.14	Wind Direction Calibration	99
9.15	WOD Calibration	99
9.15.1	WOD Calibration Main Screen.....	99
9.15.2	WOD Calibration Help Set Definitions	100
9.16	Ammonia Calibration	100
10	INSTALL MENU.....	101
10.1	Setup	101
10.2	Relay Layout	102
10.2.1	Relay Layout Main Screen	102
10.2.2	Output Function List.....	103
10.3	Analog Sensors.....	103
10.4	Digital Sensors.....	104
10.5	Analog Output.....	106
10.5.1	Analog Output Main Screen	106
10.5.2	Analog Output – Help Set Definitions.....	107
10.6	Vent/Curtain Setup.....	107
10.6.1	Using Time to Calibrate.....	107
10.6.2	Using a Potentiometer to Calibrate	108
10.6.3	Vent/Curtain Help Set Definitions	108
10.7	Temperature Definition.....	109
10.8	Fan Air Capacity	110
10.9	House Dimensions	110
10.10	Communication	111
11	APPENDIX A: OUTPUT DATA.....	112
12	APPENDIX B: BREEDER MODE	115
12.1	Egg Room Setup.....	115
12.2	Egg Counter.....	117
12.3	Egg Room Water and Feed.....	119
12.3.1	Setup.....	119
12.3.2	Water and Feed Version 6.24 and Above	121
12.4	Egg Belt Runtime	121
12.5	Egg Room Hot Screen	122
12.6	Nest Function.....	122
12.6.1	Single Relay	122

12.6.2	Dual Relay	123
12.7	Scale Arm.....	124
12.8	Weighing the Birds in Breeder.....	125
12.8.1	Auto or Auto Turkey Curve	126
12.8.2	Customized/Industrial Standard Curves.....	127
12.8.3	Bird Weight History	127
12.9	Breeder Advanced Feeding	128
12.9.1	Selecting the Advanced Feeding Mode.....	130
12.9.2	Advanced Feeding Setup.....	131
12.9.3	Feed Scale Program Help Set Definitions.....	135
12.10	Egg Room History.....	136
13	APPENDIX C: NATURAL VENTILATION	137
13.1	Natural Ventilation Setup.....	137
13.2	Theory of Operation	140
13.2.1	Transition to or from Natural Ventilation	140
13.2.2	Curtain Movement	141
13.2.3	Toggle Switches.....	141
14	APPENDIX D: DEVICE SETUP SUMMARY	142
14.1	Stir Fans	142
14.2	Attic Ventilation	143
14.3	Heaters Control	143
15	APPENDIX E: PREVIOUS VERSION FUNCTIONS	145
15.1	Scale Menu, Version 6.21 and Below	145
15.1.1	Setting up a Curve – Summary.....	145
15.1.2	Scale Layout.....	145
15.1.2.1	Scale Layout, Version 6.17 and Below	146
15.1.2.2	Scale Layout, Version 6.18 and Above	146
15.1.3	General Settings	146
15.1.3.1	General Settings Main Settings	147
15.1.3.2	General Settings Help Set Definitions	147
15.1.4	Bird Scale Setting	147
15.1.4.1	Bird Scale Setting, Version 6.18 and Below	148
15.1.4.2	Bird Scale Setting, Version 6.19	148
15.1.5	Gender Based Weighing, Version 6.21	149
15.1.5.1	Enabling Gender Based Weighing	149
15.1.5.2	Measuring Gender-Defined Bird Weights, Auto Curve	150
15.1.5.3	Measuring Gender-Defined Bird Weights, Customized/ Industrial Standard Curve	150
15.1.6	Bird Curve/Bird Weight.....	152
15.1.6.1	Bird Curve, Version 6.18 and Below	152

15.1.6.2	Bird Curve Help Set Definitions	152
15.1.6.3	Bird Weight, Version 6.19	152
15.1.7	History	154
15.1.7.1	History, Version 6.18 and Below	154
15.1.7.2	History, Version 6.19	155
15.2	Test, Version 6.18 and Below	155
15.2.1	Test, Version 6.17 and Below	155
15.2.2	Test, Version 6.18	155
15.3	Vent & Curtain Levels Help Set Definitions Version 6.18 or Below	156
15.4	Breeder Nest Function, Version 6.18 and Below	156
15.5	Nest Function, Version 6.18 and Below	157
16	WARRANTY	158

1 Introduction

1.1 Disclaimer

Munters reserves the right to make alterations to specifications, quantities, dimensions etc. for production or other reasons, subsequent to publication. The information contained herein has been prepared by qualified experts within Munters. While we believe the information is accurate and complete, we make no warranty or representation for any particular purposes. The information is offered in good faith and with the understanding that any use of the units or accessories in breach of the directions and warnings in this document is at the sole discretion and risk of the user.

1.2 Introduction

Congratulations on your excellent choice of purchasing a Platinum Pro/Rotem Pro!

In order to realize the full benefit from this product it is important that it is installed, commissioned and operated correctly. Before installation or using the controller, this manual should be studied carefully. It is also recommended that it is kept safely for future reference. The manual is intended as a reference for installation, commissioning and day-to-day operation of the Munters Controllers.

1.3 Notes

Date of release: May 2009

Munters cannot guarantee to inform users about the changes or to distribute new manuals to them.

All rights reserved. No part of this manual may be reproduced in any manner whatsoever without the expressed written permission of Munters. The contents of this manual are subject to change without notice.

2 Introduction to Standard Mode

Computerized electronic controllers such as the Platinum Pro/Rotem Pro enable farmers to raise high quality poultry by controlling the environment accurately and simply. For example, instead of struggling with individual thermostats for heat zones and ventilation, Platinum Pro/Rotem Pro brings these functions together into one convenient place.

Simplicity and *Ease of Use* are important benefits of Platinum Pro/Rotem Pro Standard Mode. Each fan and heater has its own on and off temperature. The light and feed clocks are easy to understand and apply.

The Platinum Pro/Rotem Pro Controller provides a variety of Management and History utilities. You can choose from simple overviews or fully detailed by the minute records of minimum, maximum and average temperatures for each individual sensor. The unique *Table of Events* records the moment of every significant action taken by the Platinum Pro/Rotem Pro and, optionally, its operator.

Communication software is available to users who wish to access their Platinum Pro/Rotem Pro controllers from their computers at Munters' website, www.munters.com. Munters provides technical support on the website, as well as through the large dealer and agent network.

- Front Panel, page 12
- Keypad, page 12
- Relay Switches, page 13
- Hot Screens, page 13
- Standard Display, page 14
- Main Menu Icons, page 16

2.1 Front Panel

Figure 1 shows the Platinum Pro/Rotem Pro front panel and its elements. All controllers have similar elements.

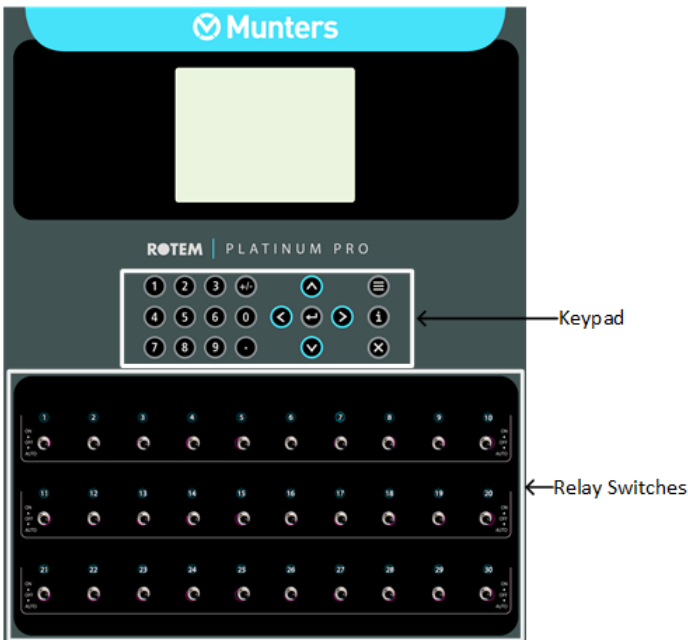

Figure 1: Platinum Pro/Rotem Pro Front Panel

The following sections detail the front panel elements.

2.2 Keypad



Enter main menu, also acts as "ESC" or "Back" keys



Access help screens and graphs



Erase typing mistakes



Enter menus, values, open windows

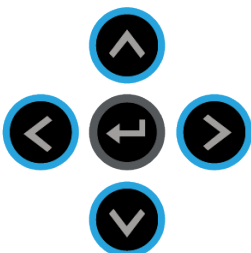

Scroll up, down, left, and right

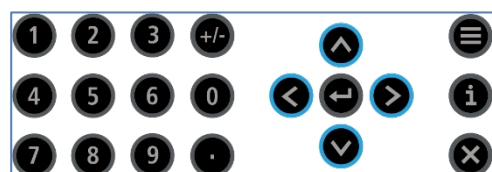

1 2 3 +/- Enter values, select options, and make selections

4 5 6 0

7 8 9 .



Toggle between positive and negative values and mark check boxes.

2.3 Hot Screens

Many of the keys serve as shortcuts. Here are the main ones:



Software version



Return to standard main screen



Temperature, humidity status, and wind chill temperature

NOTE If two humidity sensors are installed, Hot Screen 2 displays their average



Curve status



Curtain position curtain, tunnel, vent, and attic opening positions



Bird Scale and Feed Bin Status



Light Status



Analog Output Status



Temperature sensors



Silo Status



Water and Feed status



Scan through Hot Screens for five seconds each



Air Status (refer to, page for details on this screen)



Increase/ decrease offset settings



2.4 Standard Display

The main screen consists of five parts.

SENSORS		AV. TEMP.	ACTIVE	
Temp1	37.9°	27.5°	Heat	1
Temp2	16.2°		Heat. Hi	1
Temp3	28.2°	STATUS		
E. Tmp1	28.8°	08:53:06		
E. Tmp2	28.4°	Day: 5		
Press.	23	Set: 25.0	Tun. Fan	
Out T.	23.9°	Level: 3	Exh. Fan	
Hum. In	58.7%	Min. Vent	Stir	
Hum. Out	61.9%	FanOff: 176	Cool P.	
Weight	0.000		Fogger	
Weights	0		Curt. 1	100%
4 MESSAGES			Curt. 2	100%
(2) Low Feed At Bin 2			Curt. 3	0%
			Curt. 4	0%
			Ext. Sys	
			Alarm	

1. Shows individual sensor readings. Temperature sensors marked with dark squares form the current average temperature.

SENSORS	
Temp1	37.9°
Temp2	16.2°
Temp3	28.2°
E. Tmp1	28.8°
E. Tmp2	28.4°
Press.	23
Out T.	23.9°
Hum. In	58.7%
Hum.	61.9%
Out	
Weight	0.000
Weights	0

- Filled square: Indicates the sensor participates in the average calculation.

- Empty square: Indicates the sensor does not participate in the average calculation.

NOTE Refer to Table 3, page 112 to view all possible sensors.

2. Reports the current average temperature.

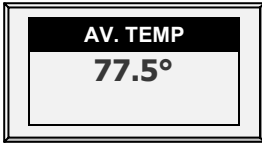

3. Shows the output relay list. The filled black boxes indicate active outputs. Controller also informs the position of inlets and curtains, as well as the number of operating heaters or fans.

NOTE Refer to Table 4, page 112 to view all possible readings.

ACTIVE	
Heat	1
Heat. Hi	1
Tun. Fan	
Exh. Fan	
Stir	
Cool P.	
Fogger	
Curt. 1	100%
Curt. 2	100%
Curt. 3	0%
Curt. 4	0%

NOTE The ACTIVE screen shows rectangular markers by the outputs. Filled rectangles indicate operating outputs; empty rectangles indicate outputs that are off.

4. Status Window gives important general information such as the time and ventilation mode.

EXAMPLE:

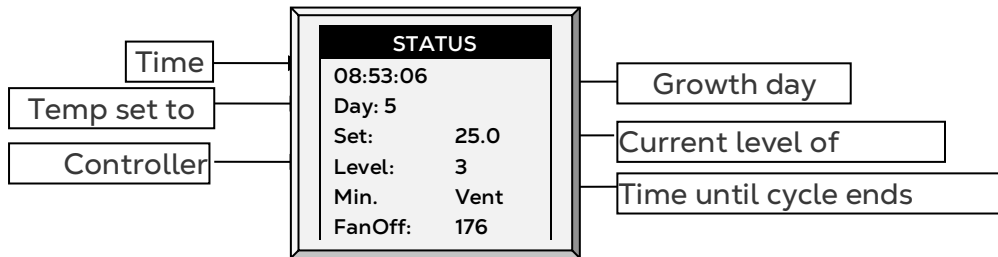

5. Displays important messages/alarms. The title bar shows the number of important messages, and if there are several messages they each appear in turn.

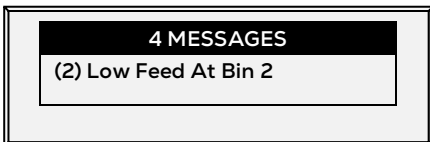

2.5 Main Menu Icons

- To enter the Main Menu screen, press Menu.
- To select an option, press Enter.

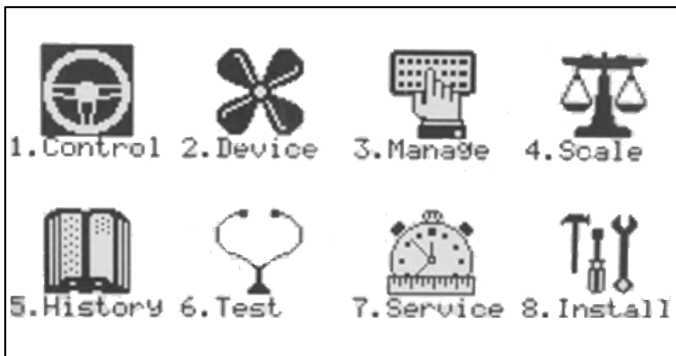

1. Control temperature, humidity, ventilation, static pressure, and system parameters.
2. Define equipment settings
3. Manage inventory, flock, and alarm/password settings.
4. Set, calibrate and test Bird Scale and Silo Scale.
5. View history of all controller functions.
6. Test to see switches, relays, communication, and alarms are functioning properly.
7. Calibrate temperature, humidity, ventilation, static pressure, feed, water, read/save to plug.
8. Install sensors, devices, communication, etc.

2.6 Rotem Pro LEDs

Rotem Pro features LEDs on each relay panel. These LEDs turn red on all relay cards when there is any active alarm (even one); they are white when there are no alarms. Refer to the main screen to view the alarms.

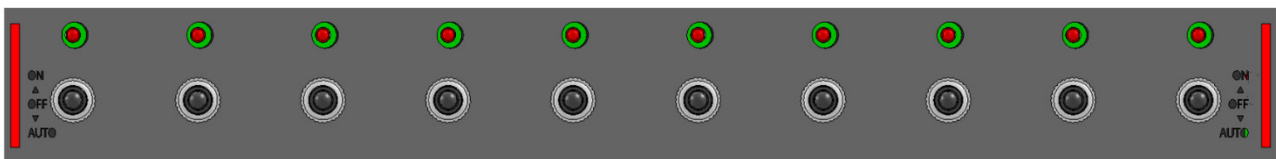

2.7 Selecting the Mode

Platinum Pro/Rotem Pro runs in two modes: Broiler and Breeder.

To select the mode:

1. Open the door. Locate the keyboard.
2. Disconnect the power cable from the power source.
3. On the keyboard, press the Delete button and reapply power. The Cold Start screen appears.
4. Select Yes. Choose Controller Type appears.
5. Select the required mode.
6. Press Enter.

NOTE The manual is based on the Broiler Mode. Functions that are unique to Breeders are described in a separate appendix.

- Appendix B: Breeder

2.8 Software Version Screen

To view the current mode, software version, versions of installed cards, and versions of accessories, go to the Main Screen and press Help.

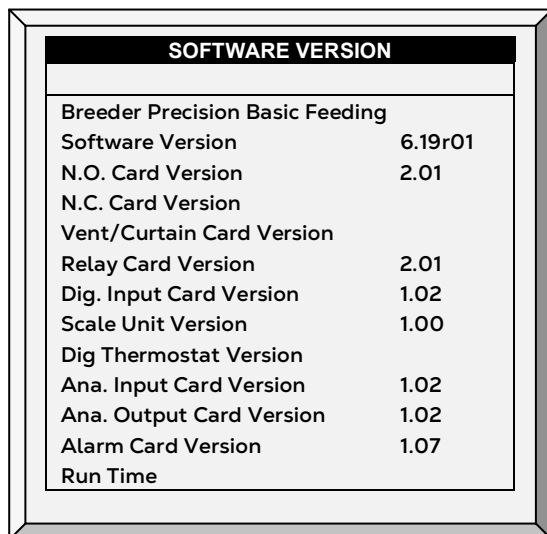

SOFTWARE VERSION	
Breeder Precision Basic Feeding	
Software Version	6.19r01
N.O. Card Version	2.01
N.C. Card Version	
Vent/Curtain Card Version	
Relay Card Version	2.01
Dig. Input Card Version	1.02
Scale Unit Version	1.00
Dig Thermostat Version	
Ana. Input Card Version	1.02
Ana. Output Card Version	1.02
Alarm Card Version	1.07
Run Time	

3 Control Menu

The following sections detail:

- Temperature Curve, page 18
- Humidity Treatment, page 20
- Minimum Vent Timer, page 21
- Timer Settings, page 24
- Static Pressure, page 25
- Control Mode, page 27
- System Parameters, page 28
- CO2 Treatment, page 28
- Ammonia Treatment, page 30
- Water Dosing, page 31

3.1 Temperature Curve

- Temperature Curve Main Screen
- – Curve Help | Set

3.1.1 TEMPERATURE CURVE MAIN SCREEN

For every growth day define the desired target temperature.

TEMPERATURE CURVE				
Day	Temp.	Low Alarm	High Alarm	T.Hi Alarm
1	89.0	84	102	103
2	89.0	84	102	103
3	87.0	82	95	103
7	84.0	80	95	103
15	82.0	78	93	103
21	79.0	75	90	103
28	76.0	71	87	103
35	72.0	67	84	103
42	70.0	63	83	103
48	68.0	60	83	103

1. In *Install* > *Analog Sensors* (refer to - *Sensors*, page 103), designate the required number of sensors as temperature sensors. When using more than one sensor, Platinum Pro/Rotem Pro begins treatments based on the average.
2. If required, go to *Service* > *Temperature Calibration*, calibrate the sensors (refer to - *Calibration*, page 86).
3. In *Install* > *Temperature Definition* (refer to - *Definition*, page 109), assign specific sensors brood setups, heater zones, and devices. If a zone does not have an assigned sensor, calculations are based on the current average temperature.

4. In *Control > Temperature Curve*, define the required target temperature curve

- Set up to 20 lines, 999 growth days. When a curve is not required enter temperatures in the first line only.
- Define:
 - Day: Set Growth Day.
 - Temp.: Set the temperature that triggers heating to begin.
 - Alarm Low & High: Set alarms for when the temperature is too LOW and too HIGH.
 - Version 6.23 enables setting the temperature alarms to 0.X degrees (only when the temperature is set to Celsius).

TEMPERATURE CURVE						
Day	Target	Heat	Tunnel	Alarm		T.Hi
				Low	High	
1	31.7	31.7	37.8	28.9	38.9	39.4
2	31.7	31.7	37.2	28.9	38.9	39.4
3	30.5	30.6	36.1	27.8	35.6	39.4
7	28.9	28.3	32.8	26.7	35.6	39.4
15	27.8	27.2	31.7	25.6	33.9	39.4
21	26.1	25.6	30.0	23.9	32.2	39.4
28	24.4	23.3	27.2	21.7	30.6	39.4
35	22.2	21.1	25.0	19.4	28.9	39.4
42	21.1	20.0	23.9	17.2	28.3	39.4
48	20.0	20.0	22.8	15.6	28.3	39.4

- T.Hi: Set a high temperature alarm for Tunnel mode.

3.1.2 TEMPERATURE CURVE HELP | SET

- ② While viewing the Temperature Curve menu: Press *HELP*, select *SET*, and press *ENTER*.

SYSTEM PARAMETERS	
TEMPERATURE CURVE	
Temperature Curve Offset	0.0
Set Temp. Change Reminder (Diff)	3.0

- Temperature Curve Offset: Adjustment of all curves either by warmer or cooler temperatures than the one programmed in the curve. This enables the user to set only this parameter instead of defining all the other parameters once again.
- Set Temp. Change Reminder (Diff): Sets the change in set temperature triggering a reminder to set backup thermostats. Often producers forget to set backup thermostats as their birds grow from baby chicks to market age, so the Platinum Pro/Rotem Pro reminds you. When you press Enter to acknowledge the reminder, the Platinum Pro/Rotem Pro logs it in the Table of Events.

NOTE '0' disables this parameter (if value is changed an appropriate message is displayed).

3.2 Humidity Treatment

- Humidity Main Screen
- Humidity Treatment Help | Set Definitions

3.2.1 HUMIDITY MAIN SCREEN

Humidity treatment enables keeping humidity levels within defined levels by controlling the air exchange. Platinum Pro/Rotem Pro uses a combination of vent openings and ventilation to maintain these levels. When the relative humidity rises above the defined levels, the fans' minimum on time increases by the levels defined in the table below.

- Humidity treatment is functional only when the controller employs minimum ventilation (cycle).
 - If the temperature rises and fans switch to continual operation, Humidity Treatment stops. Humidity Treatment does not prevent the fans from entering continual operation.
 - All fans switch from Minimum Ventilation (cycle ventilation) to continual ventilation as defined in the Temp and Timer Settings screen (refer to Option, page 34). If one fan runs in Minimum Ventilation, Humidity Treatment continues even if other fans operate continually.
- The maximum on time is [cycle time – minimum off time].
- Treatment ends when the relative humidity drops below [target – band].
- When treatment is in progress, the Main Screen displays the Humidity Status.

HUMIDITY TREATMENT		
Day	Humidity (%)	Vent Change
1	40	10
7	50	10
10	50	7
15	55	7
20	60	7
28	65	5
30	70	5

1. In *Install* > *Analog Sensors* (refer to - *Sensors*, page 103), designate up one or two sensors as indoor humidity sensors (outdoor sensor is for information only). When using two sensors, begins treatments based on the average.

2. If required, go to *Service* > *Humidity Calibration*, and calibrate the sensors (refer to - *Calibration*, page 87).

3. In *Control* > *Humidity Treatment* set the parameters as required.

- **Day:** Growth day. Can set multiple programs for same day (Maximum number of programs: 20)
- **Humidity %:** Relative humidity target at which to begin treatment
- **Ventilation Change%:** Increase minimum ventilation ON time by this percentage.

NOTE The increase in ventilation occurs one time only. There is no additional change in the ventilation On Time. For example in the Humidity Treatment chart above, on Day 7, 1) if the humidity is above 50% and 2) at least one fan is in Minimum Ventilation (refer to . & Timer Setting, page 33), then the ON time increases by 10%.

4. Set the Help parameters.
5. Set the Humidity Sensor Alarm (page 63).

3.2.2 HUMIDITY TREATMENT HELP | SET DEFINITIONS

- ② While viewing the Humidity Treatment menu: Press **HELP**, select **SET**, and press **ENTER**.

Humidity Treatment	
Band (Below Target) %	2.0
Delay Before Treatment (Sec)	0
Cycle Minimum OFF Time (sec)	60
Humidity Below Heat	No

- Band (Below Target) %: Once treatment begins, it continues until the relative humidity drops to [target – band].
- Delay Before Treatment (Sec): Once the relative humidity rises about the permitted level, Platinum Pro/Rotem Pro waits this amount of time before beginning treatment.
- Cycle Minimum OFF Time (sec): The minimum amount of time treatment ceases in each cycle.
- Humidity Below Heat: Enable humidity treatment when the temperature is below the target heat.

3.3 Minimum Vent Timer

This option enables the user to set the minimum ventilation timing.

- - Does Minimum Ventilation Work?
- - up Minimum Ventilation
- Ramping Timer Help | Set
- Additional Details

3.3.1 HOW DOES MINIMUM VENTILATION WORK?

Ventilation time in the Platinum Pro/Rotem Pro runs in two modes:

- **Minimum ventilation (MV):** Fans run in an on/off cycle, where the cycle time changes as the temperature changes. Change in the cycle time only happens after a user-defined delay. Since temperatures can fluctuate constantly, the delay ensures stable fan speeds.
- **Continual operation:** Fans remain on until the temperature drops

Figure 5 illustrates the ventilation modes.

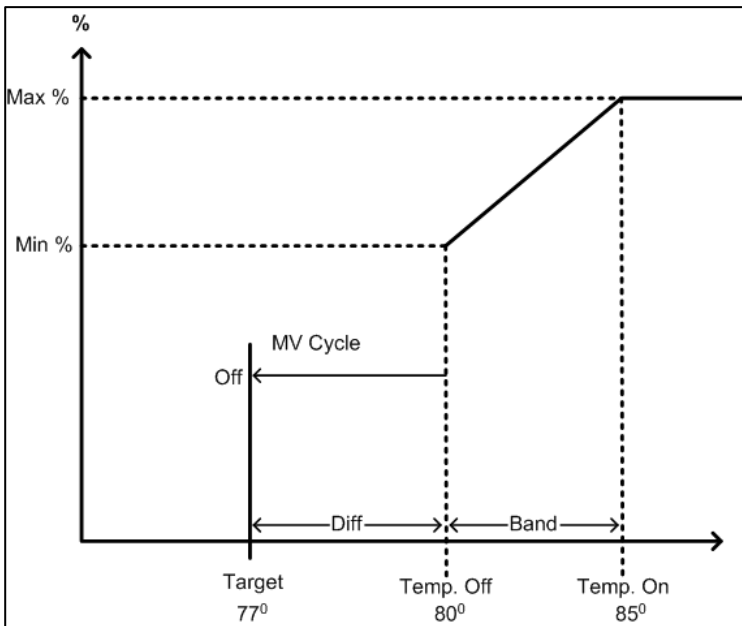

Figure 2: Minimum Ventilation

As shown in the graph:

- When the temperature is below the target temperature, ventilation is off.
- When the temperature is between the Target and Temp. Off temperatures (labeled Diff in the graph) (refer to Figure 6):
 - If the temperature is rising, the fans run according to the cycle settings
 - If the temperature is dropping, the fans continue to run at the calculated on/off time value



Figure 3: Minimum Ventilation Schemes

- When the temperature is between the Temp. Off and Temp. On temperatures (labeled Band in the graph), the fans run according to the calculated on/off time.
- When the temperature is above the Temp On temperature, the fans run continuously.

In Figure 5:

- Fans are off below 75°

- Between 75° - 80° fans run:
- At minimum ventilation if the temperature is rising
- At the calculated on/off time if the temperature is dropping
 - Between 80° - 85°, the fans run at the calculated on/off time
 - Above 85° the fans run continuously.

3.3.2 SETTING UP MINIMUM VENTILATION

This procedure describes the setup for a house using powered minimum ventilation.

MINIMUM VENT TIMER		
Day	Fans (sec)	
	On	Off
1	30	270
5	60	240
21	120	180
35	180	120
0	0	0
0	0	0
0	0	0
0	0	0
0	0	0

1. In *Installation > Setup*, enable **Minimum Vent**.
2. In *Device Setting > Temp & Timer Setting* for the required fans set the parameters as required.
3. In *Control > Minimum Vent Timer* define:
 - **Day**: Set the growth day.
 - **Fans On/Off**: Set the on/off cycle times.
4. Set the [Ramping Timer Help](#) parameters as required.

3.3.3 RAMPING TIMER HELP | SET

- ② While viewing the Minimum Vent Timer: Press **HELP**, select **SET**, and press **ENTER**.

SYSTEM PARAMETERS	
RAMPING TIMER	
Ramping Enable	NO
Increase Decrease Time (sec)	60
Ventilation Change (%)	30
Minimum OFF Time (sec)	60
Diff Above SET to Start Ramping	1.0

Ramping means a temporary change in the minimum ventilation. Ramping operates in two manners:

- **Increase**: When the temperature rises above [Set Temperature + Difference above Set], the minimum ventilation increases by the amount (percentage) set in Ventilation Change.
- **Decrease**: When the temperature is below [Set Temperature + 0.5° F], the minimum ventilation decreases by the amount (percentage) set in Ventilation Change.

- **Ramping Enable:** Set to No/Yes.
- **Increase Decrease Time:** When ramping ventilation begins, the fans operate at the increased or decreased rate for this amount of time.
- **Ventilation Change:** This parameter determines the amount of change in the Fan Air Capacity. For example, if the capacity is 20,000 CFM and the change is 20%, the CFM's increases to 24,000 CFM. The second time the CFM will increase to 28,800 CFM. Range 5 – 50%; default 20%.
- **Minimum OFF time (sec):** This parameter determines the minimum ventilation off time. Range 10 – 300 seconds; default 60 seconds.
- **Diff Above SET to Start Ramping:** The differential above the Set Temperature point at which ramping increase begins.

3.3.4 ADDITIONAL DETAILS

- When the temperature begins to decrease, the fans remain at the same cycle until the temperature reaches the off temperature. For example, in Figure 5 if the fans are running continually when the temperature drops to 80°, they continue to run continually until the temperature reaches 75°. If the temperature is 78° when the temperature begins to drop, the fan cycle remains the same until the temperature reaches 75°.
- If a heater goes on, all fans begin working at Minimum Ventilation automatically.
- After a power outage, the cycle runs at Minimum Ventilation.

3.4 Timer Settings

This section enables setting the timer schedule. Timers control the cooling devices (foggers/cooling pads) on/off schedule

TIMER SETTINGS		
Timers	On (sec)	Off
[1]	2	78
[2]	1	6
[3]	0	0
[4]	2	7

1. Define the number of seconds the timer is ON and OFF.
2. In *Device > Temp & Timer Settings*, scroll to each cooling device.
3. Under option, select a timer setting.

NOTE Unlike the *Min. Vent Timer*, this cycle timer also operates above the set temperature.

3.5 Static Pressure

This section controls air pressure during minimum ventilation. Set the static pressure parameters in the following screen.

- Static Pressure Main Screen
- - Static Pressure
- - Pressure Help | Set Definitions

3.5.1 STATIC PRESSURE MAIN SCREEN

STATIC PRESSURE	
Minimum Ventilation	
1st Low Pressure	0.080
1st High Pressure	0.120
2nd Low Pressure	0.060
2nd High Pressure	0.100
Low Pressure Alarm	0.010
High Pressure Alarm	0.210
Tunnel Ventilation	
Low Press.	0.060
High Press.	0.100
Low Pressure Alarm	0.010
High Pressure Alarm	0.150
Attic	
Low Pressure Setting	0.040
High Pressure Setting	0.060

Minimum Ventilation

- **1st Low Pressure:** Set desired static pressure for low outside temperature conditions. Be sure that there is proper airflow at this setting.
- **1st High Pressure:** Set desired static pressure for high temperature conditions. Normally this pressure is lower to obtain a larger air inlet opening.

NOTE Controller interpolates between the LOW and HIGH Temperature.

- **Low Pressure Alarm:** Set alarm for low static pressure. If you disable it by setting zero, the Platinum Pro/Rotem Pro warns you and enters a record in the Table of Events.
- **High Pressure Alarm:** Set alarm for high static pressure.

Tunnel Ventilation

- **Low Pressure:** Set required low pressure for Tunnel Ventilation (minimum opening).
- **High Pressure:** Set required high pressure for Tunnel Ventilation (maximum opening).
- **Low Pressure Alarm:** Set alarm for low static pressure.
- **High Pressure Alarm:** Set alarm for high static pressure.

Attic

- **Low Pressure:** Set required low pressure for Attic Ventilation (minimum opening).

- **High Pressure:** Set required high pressure for Attic Ventilation (maximum opening).

3.5.2 DISABLING STATIC PRESSURE

To disable the static pressure function:

1. Go to *Installation > Setup*.
2. Set the Static Pressure Unit to **None**.

The main screen then stops:

- displaying the pressure
- displaying High Pressure and Pressure Sensor Failure alarms

NOTE If either of these alarms were active before disabling the static pressure, the main screen continues to display the alarms. Reset the alarms once.

3.5.3 STATIC PRESSURE HELP | SET DEFINITIONS

① While viewing the Static Pressure menu: Press **HELP**, select **SET**, and press **ENTER**.

SYSTEM PARAMETERS	
STATIC PRESSURE	
Wind Gust Delay Time (sec)	10
Static Pressure During Tunnel	YES
Transitional Tunnel	NO
Minimum Vent Using	VENT
Emergency S. Press. Delay (sec)	60
Curt. Pos. In Emerg. S. Press. %	100
Min. Tunnel Curtain. Level (%)	50
Min. Tunnel Curt. % To Start Fan	25
2nd S.P. At This Fan Temp. ON	None

- **Wind Gust Delay Time (sec):** Set length of time (seconds) before starting Static Pressure control after an unexpected change in air pressure.
- **Static Pressure During Tunnel:** Select **YES** or **NO** for using Static Pressure control when in Tunnel mode.
- **Transitional Tunnel:** Select **YES** or **NO** for using tunnel inlets when static pressure is high and vents are already at 100%
- **MinVent Using:** Select **Vent** or **Tunnel** for controlling static pressure when in minimum ventilation.
- **Emergency S. Press. Delay (sec.):** Length of time Platinum Pro/Rotem Pro waits before taking emergency action when static pressure remains above the high-pressure alarm setting. Note that chronologically it is important to open and go to the next setting.
- **Curtain Position in Emergency Static Pressure %:** Set the position non-active curtains should go to in an emergency pressure situation.
- **Min Tunnel Curtain Level (%):** When using static pressure in tunnel mode, tunnel inlet opens at least this far in tunnel mode.
- **Min Tunnel Curtain % to Start Fan:** Set a value that serves as a minimum to begin fan operation in tunnel mode.

- **2nd S.P. At This Fan Temp ON:** When the defined fan turns on, Platinum Pro/Rotem Pro switches to the second static pressure parameter.

NOTE Refer to menu Install > Curtain Setup Help > Set for defining additional settings.

3.6 Control Mode

- Control Mode Main Screen
- Catching Mode

3.6.1 CONTROL MODE MAIN SCREEN

Choose house operating modes, turn temperature curves on or off and select which type of min/max level method to use.

CONTROL MODE	
Growing Zone	FULL HOUSE
House Mode	Normal
Temperature Curve	ON
Minimum Vent. Curve	OFF
Tunnel	ALLOWED
Cooling Ramping	NO

- **Growing Zone**
 - House Mode: Normal
 - Empty: All alarms and functions are disabled
 - Catching: Refer to Catching Mode.
- **Empty House Mode:** Select YES to disable all alarms.
- **Temperature Curve:** Select NO to disable curve. Temperature settings become fixed values.
- **Minimum Vent Curve:** Set ON/OFF for automatic minimum ventilation ramping
 - On: A curve according to days
 - Off: Time changes at start day of each line in Min Vent tables
- **Tunnel:** Select either to NOT ALLOW or ALLOW tunnel ventilation.
- **Ramping:** Enables cooling ramping (Version 6.22). Refer to Cool Pad (Ramping), page 36.

3.6.2 CATCHING MODE

CONTROL MODE	
Growing Zone	FULL HOUSE
House Mode	Catching
Temperature Curve	ON
Minimum Vent. Curve	OFF
Tunnel	ALLOWED
Cooling Ramping	NO

Catching Mode is used when birds are being removed from the chicken house. In this mode:

- You can limit light intensity and ventilation
- The following functions are disabled.
 - Humidity/CO2/Ammonia treatment
 - Heating
 - Foggers
 - Water and feed
 - WOD
 - Nipple flushing
 - Feeders and drinkers control
- High/low temperature and high static pressure alarms are active. All other alarms are disabled.

To configure Catching Mode.

1. In Control > Control Mode, define House Mode as Catching.

2. In Control > Control Mode > Settings define:

- Light Intensity: Default 0%, range 0-100%
- Temp & Pressure Alarms Enable: Define as Yes or No.
- Level of Ventilation: 0 means ventilation works automatically. 1 – 30 sets the ventilation mode.

3.7 System Parameters

System Parameters consolidate all the HELP | SET menus into one scroll screen.

Page	System Parameter	Page	System Parameter
43	Light	19	Temperature Curve
41	Water & Feed	26	Static Pressure
58	Feed Inventory	34	Temp & Timer Settings
61	Alarm Setting	34	Stir Fans
40	Foggers	34	Radiant Heaters
47	V. Speed Settings	36	Cooling Pad
107	Curtains	34	Attic

3.8 CO2 Treatment

- CO2 Main Screen
- CO2 Treatment Help | Set Definitions

3.8.1 CO2 MAIN SCREEN

CO2 treatment forces an increase in ventilation level when the CO2 level is too high. When the CO2 level rises above the user-defined level, ventilation increases by a user-defined amount. If during treatment, the CO2 level drops below the Stop Value parameter, the ventilation level automatically returns to that level used before CO2 treatment was initiated.

- Version 6.19 and below support one CO2 sensor.
- Version 6.20 supports two CO2 sensors. If two sensors are installed, the Main Screen displays the average.

CO2 TREATMENT			
Day	Start Value	Stop Value	Vent Change (%)
1	3000	2500	10
7	2700	2200	20
14	2500	2000	30
0	0	0	0
0	0	0	0
0	0	0	0
0	0	0	0
0	0	0	0
0	0	0	0
0	0	0	0
0	0	0	0
0	0	0	0

1. In *Install* > *Analog Sensors* (refer to 89BAnalog Sensors, page 103), designate one sensor as a CO2 sensor.

2. If required, go to *Service* > *CO2 Calibration*, calibrate the sensors (refer to *Sensor*, page 87).

3. In *Control* > *CO2 Treatment* set the parameters as required.

- **Day:** Growth day. You can set multiple programs for same day (maximum number of programs: 20)
- **Start Value:** CO2 value at which to begin treatment (Range 100 – 5000)
- **Stop Value:** CO2 value at which to end treatment (Range 100 – 5000)
- **Vent Change (%):** Percentage increase in ventilation

3.8.2 CO2 TREATMENT HELP | SET DEFINITIONS

② While viewing the CO2 Treatment menu: Press *HELP*, select *SET* and press *ENTER*.

SYSTEM PARAMETERS	
CO2 TREATMENT	
Delay Before Treatment (sec)	0
Cycle Minimum OFF Time (sec)	60
CO2 Treatment below Heat	NO

- **Delay Before Treatment (sec):** Number of seconds the controller pauses before ventilating
- **Cycle Minimum OFF Time (sec):** The minimum amount of time that the fans do not operate during a cycle.
- **CO2 Treatment below Heat:** Select YES or NO to enable CO2 treatment when heaters are operating (set in Temperature Curve).

3.9 Ammonia Treatment

- Ammonia Main Screen
- Ammonia Treatment Help | Set Definitions

3.9.1 AMMONIA MAIN SCREEN

Ammonia treatment forces an increase in ventilation level when the ammonia level is too high. To prevent fans changing their ventilation too often, treatment begins after a user-defined delay.

If during treatment, the ammonia level drops below the **Stop Value** parameter, the ventilation level automatically returns to that level used before ammonia treatment began.

AMMONIA TREATMENT			
Day	Start Value	Stop Value	Vent Change (%)
1	25	10	0
7	25	10	0
14	25	10	0
0	25	10	0
0	25	10	0
0	25	10	0
0	25	10	0
0	25	10	0
0	25	10	0
0	25	10	0
0	25	10	0

➤ This function requires an ammonia sensor.

1. In *Install* > *Analog Sensors* (refer to Analog Sensors), designate one sensor as an ammonia sensor.
2. If required, go to *Service* > *Ammonia* and calibrate the sensors (refer to Ammonia Calibration).
3. In *Control* > *Ammonia Treatment* set the parameters.
 - **Day:** Growth day. You can set multiple programs for same day (maximum number of programs: 20)
 - **Start Value:** Ammonia value at which to begin treatment. Range: 0 to 100. Default: 2

NOTE Ammonia levels should not be higher than 30 ppm.

- **Stop Value:** Ammonia value at which to end treatment. Range: 0 to 100. Default: 2. The stop value must be lower than the start value.
 - **Vent Change (%):** Percentage increase in ventilation
4. Set the Ammonia Alarm (page 63).

3.9.2 AMMONIA TREATMENT HELP | SET DEFINITIONS

- ② While viewing the Ammonia Treatment menu: Press **HELP**, select **SET**, and press **ENTER**.

SYSTEM PARAMETERS	
AMMONIA TREATMENT	
Delay Before Treatment (sec)	0
Cycle Minimum OFF Time (sec)	60
Ammonia Treatment below Heat	NO

- **Delay Before Treatment (sec):** Number of seconds the controller pauses before ventilating
- **Cycle Minimum OFF Time (sec):** The minimum amount of time that the fans do not operate during a cycle.
- **Ammonia Treatment below Heat:** Select YES or NO to enable ammonia treatment when heaters are operating (set in Temperature Curve).

3.10 Water Dosing

Platinum Pro/Rotem Pro Version 6.20 support specific dosing pumps used to inject additives into the water supply. From the controllers you can define the type of pump used, the additive, dosage rate, and additive amount.

- Dosing Pump Main Screen
- Dosing Pump Settings Screen
- Dosing Hot Screen

NOTE Version 6.20 supports one pump. Version 6.22 supports up to four pumps. All pumps use the same additive and dosage rate.

3.10.1 DOSING PUMP MAIN SCREEN

1. In Install > Digital Sensor, select Pump Cycle Meter (one).
2. In Install > Digital Sensor, select Pump Additive Over (optional).
3. Repeat for each set of sensors (Version 6.22).
4. Go to Control > Dosing Pump.

DOSING PUMP SETTINGS	
Pump #	1
Pump Type	0.8 Fixed
Additive Name	None
Dosage Rate	0.8
Additive Amount (gal)	0

5. Define:

- **Pump #:** Select the number of the pump for which you want to edit the parameters.
- **Pump Type:** Select the type of pump being used.

- 0.8 Fixed: This pump provides a fixed dosage rate (0.8%).
 - 0.3 – 2 Variable: This pump provides a variable rate between 0.3 to 2.5%.
- Additive Name: Select an option from the list.
- Dosage Rate: If you defined the pump type as variable, define the dosage rate. Default: 0.8%
 - The dosage volume per pulse is 400 cc (water and additive). The dosage volume of the additive is 400 x the rate. For example 400 x 0.8 = 3.2 cc.
- Additive Amount: Define the number of liters of additive.

3.10.2 DOSING PUMP SETTINGS SCREEN

② When viewing the Dosing Pump Settings Menu: Press Help, select Set, and press Enter.

Dosing	
Dosing Shortage Alarm Time (sec)	20

- Dosing Shortage Alarm Time (sec): Define the amount of time that must pass when additives cease to be added before an alarm is triggered. Range: 1 – 9999 seconds. 0 disables the alarm. Default: 20.

3.10.3 DOSING HOT SCREEN

Press the 2 and Up Arrow to view the Dosing Hot Screen.

DOSING MEASUREMENTS			
Additive	Work Time	Water (gal)	Dose (gal)
1 None	00:00:00	0.0	0.000
2 None	00:00:00	0.0	0.000
3 None	00:00:00	0.0	0.000
4 None	00:00:00	0.0	0.000

4 Device Menu

- Temp & Timer Setting, page 33
- Cool Pad, page 35
- Fogggers, page 36
- Water & Feed, page 40
- Light, page 42
- Extra Systems, page 45
- Variable Speed Fan Setting, page 46
- Water on Demand, page 48
- Feed Scale Program, page 50

DEVICE
1. TEMP & TIMER SETTING
2. COOL PAD
3. FOGGERS
4. WATER & FEED
5. LIGHT
6. EXTRA SYSTEMS
7. VARIABLE SPEED FANS
8. WATER ON DEMAND
9. FEED SCALE PROGRAM

4.1 Temp & Timer Setting

- Temp & Timer Main Screen
- - & Timer Settings Help | Set

4.1.1 TEMP & TIMER MAIN SCREEN

This section enables the user to set the temperature and the timer setting for all heating and cooling devices.

NOTE Refer to Appendix D: Device Setup Summary.

TEMP & TIMER SETTINGS				
Device	ON	OFF	MT	Option
Tunnel Fan 2	88.0	85.0	✓✓	----
~Tunnel Fan 1	88.0	85.0	~✓	Min. V
TUNNEL SETTING	88.0	85.0		
Stir Fan 1	81.0	82.0		
Fogger 1	83.0	82.0	~✓	Timer1
Exhaust Fan 2	81.0	82.0	~✓	Timer1
~Exhaust Fan 1	81.0	80.0	✓✓	----
SET TEMPERATURE	80.0			
Heat 2	75.0	76.0		
Heat 1	75.0	76.0		

1. Define devices as required in the Installation Menu (Relay Layout, Analog Sensors, and Analog Output).
2. Define the fields as required.
 - **Device:** Read only. This column lists the devices defined in the Installation Menu.
 - **On/Off:** Set the temperature at which the device starts/stops operating.

- **MT:** These letters stand for Minimum Ventilation/Tunnel. Press the +/- key to enable each cooling device to work in the mode(s) required. You can choose both modes if required.

NOTE *Minimum Vent (Power) and Tunnel Ventilation must be enabled in Installation > Setup for this function to operate.*

- **Option:** Set the timing method for each device. The choices available depend on the device.
 - Ventilation device:
 - **Min.V:** The device only works according to the On/OFF schedule set in *Control > Minimum Vent Timer*. It does not switch to tunnel mode.
 - This ventilation device works according to the on/off temperature only (no cycling). When the temperature is above the ON temperature, the fan remains on. When the temperature is below the OFF temperature, the fan remains off. In between those two temperatures
 - Foggers and cooling pads:
 - **Timer 1/2/3/4:** The cooling device operates between the temperatures set in the Temperature and Timer Settings screen, according to the on/off schedule defined in *Control > Timer Setting*. Select which timer defines the schedule.
 - **Program:** This selection disables the parameters set in this page. The cooling device works according to the device's program screen. Foggers operate according to the parameters set in *Control > Foggers*. Cooling pads operate according to the parameters set in *Control > Cooling Pad*.
 - This cooling device works according to the on/off temperature only (no cycling).
 - When the temperature is above the ON temperature, the fans operate.
 - When the temperature is below the OFF temperature, the fans cease to operate.

3. Define the help settings as required.

4.1.2 TEMP & TIMER SETTINGS HELP | SET

- ① *While viewing the Temp & Timer Settings menu: Press HELP, select SET, and press ENTER.*

TEMP & TIMER SETTINGS	
Minimum Tunnel Fans On	4
Tunnel Exit Delay (minutes)	5
Non Brood Area Diff. From Heat	-
	99.0

- **Minimum Tunnel Fans On:** The minimum number of fans in tunnel entry. If there are not enough fans to operate according to temperature, the fans with the lower temperatures will be added in order to reach that number. If enough fans that can operate in tunnel do not exist, an alarm will be activated.

- **Tunnel Exit Delay (minutes):** The time Platinum Pro/Rotem Pro waits after satisfying tunnel exit conditions.
- **Non brood Area Diff. From Heat:** Set point for non-brood heaters. Can be either positive or negative where positive = warmer and negative = cooler. (-99) = heaters not operating.

4.2 Cool Pad

- Cool Pad (Standard)
- Cool Pad (Ramping)

4.2.1 COOL PAD (STANDARD)

The following section describes the Cool Pad function, Version 6.21 and below.

- Cool Pad Main Screen
- Cool Pad Help | Set Definitions

4.2.1.1 Cool Pad Main Screen

This menu sets the operating conditions for the Cool Pad.

COOLING PAD						
Day	Start Time	End Time	On Temp Diff	To Hum	On sec	Off sec
1	10:00	21:00	3.0	99	15	285
7	10:00	21:00	3.0	99	15	285
7	10:00	21:00	5.0	99	45	255
14	10:00	21:00	2.0	99	15	285
14	10:00	21:00	3.0	99	30	270
14	10:00	21:00	4.0	99	45	255
14	10:00	21:00	5.0	99	60	240
14	10:00	21:00	6.0	99	75	225
14	10:00	21:00	7.0	99	100	200
14	10:00	21:00	8.0	99	200	100

1. In *Installation > Relay Layout*, define a relay(s) as cooling pad.
2. In *Device > Cooling Pad*, define the parameters below.
3. In *Device > Temp & Timer Settings*, scroll to each cool pad.
4. Under Option, select Prog.

NOTE To enable this screen, you must select Prog.

5. Set the Help parameters as required.
 - **Day:** Set growth day.
 - **Start Time:** The cool pad begins operating.
 - **End Time:** The cool pad ceases to operate.

- It is possible to set multiple start and stop times for a single day.
- In the screen above, growth day jumps from day 7 to day 14, the cool pad continues to work according to day 7 settings from growth day 7 through growth day 14.
- **On Temperature Difference:** Set difference from tunnel temperature to use this setting. You can use negative differential temperatures.
 - Note the settings for Day 14. Platinum Pro/Rotem Pro uses the maximum temperature differential that applies to choose the correct settings.
- **To Humidity:** Set maximum humidity allowed before stopping cool pad. You can enter 100%.
- **On Sec:** Set the maximum on time for each cycle of cool pad operation.
- **Off Sec:** Set the minimum off time for each cycle of cool pad operation.

4.2.1.2 Cool Pad Help | Set Definitions

② While viewing the Cool Pad menu: Press **HELP**, select **SET**, and press **ENTER**.

SYSTEM PARAMETERS	
COOL PAD	
Humidity Band (%)	2.0
Flush Cool Pad At:	00:00
Cool Pad Flush Duration (minute)	0

- **Humidity Band (%):** Define the on/off hysteresis relative to humidity.
- **Flush Cool Pad At:** Set time of day (hh:mm) to start a continuous application of water to the cool cells in order clean them of any deposits.
- **Cool Pad Flush Duration (minutes):** Set the length of time in minutes for flushing. If parameter is set, flush is applied without regard to ventilation level or operating mode.

Example: Cool Pad ON temperature = 80°, Diff set to 2° F:

Cool Pad #	Assigned Sensor	Diff Between Cool Pads Stage	Actual ON Temperature
1	Average	0.0	80°
2	Average	2.0	82°
3	Temp Sensor 2	0.0	80°
4	Temp Sensor 2	2.0	82°

4.2.2 COOL PAD (RAMPING)

As an option, Version 6.22 supports Cool Pad Ramping. Please note that Version 6.22 also supports the non-ramping option.

- Introduction to Cool Pad Ramping
- Cool Pad Main Screen
- Cool Pad Help | Set Definitions

4.2.2.1 Introduction to Cool Pad Ramping

Ramping means that the user defines under what climatic conditions cool pads begin to operate (sequentially or simultaneously). In addition, the user defines the cool pads minimum and maximum off times. As the temperature changes, the controller automatically adjusts the off time. The cool pad(s) continues to operate until the temperature decreases to a user-defined point. The user sets the following parameters to configure ramping:

- On/Off temperatures.
- Ramping range is the temperature range (above the Cool Pad ON temperature) in which ramping takes places. If the temperature rises above the defined range, ramping ceases.
- The user defines the On time, which remains constant for each day, and the minimum/maximum Off times. The controller automatically adjusts the Off time as the temperature changes.
- You can specify which hours during the day when cooling can take place.
- You can define how the humidity affects the cool pads.

NOTE Incorporating humidity levels in the operating parameters requires installing a humidity sensor. Invalid sensor readings disable these conditions.

4.2.2.2 Cool Pad Main Screen

➔ Define relays as cool pads. Refer to Relay Layout, page 129.

To configure Cool Pad Ramping:

1. Go to Control > Control Mode and enable Cooling Ramping.

CONTROL MODE	
Growing Zone	FULL HOUSE
House Mode	NORMAL
Temperature Curve	YES
Minimum Vent Curve	OFF
Tunnel	ALLOWED
Cooling Ramping	YES

2. Go to Device > Temp & Timer Setting.

TEMP & TIMER SETTINGS				
Device	ON	OFF	MT	Option
Cooling Pad 2	88.0	85.0	✓✓	----
Cooling Pad 1	88.0	85.0	-✓	Min. V

3. Define the On and Off temperatures. For details on other parameters, refer to Temp & Timer Settings.

4. Go to Device > Cool Pad.

COOL PAD			
Day	On Time	Max Off Time	Min Off Time
1	0	0	0
7	0	0	0
12	0	0	0
14	0	0	0
16	0	0	0
18	0	0	0
20	0	0	0
22	0	0	0
25	0	0	0
30	0	0	0

5. Define:

- **Day:** Defines the growth day at which the cooling function takes place. Only one line per day is valid. If more than one lines defines the same day, the last line only defines the function.
- **On Time:** Define the operating time. Range: 0 – 999 seconds. Default: 0
- **Maximum Off Time:** Define the maximum amount of time that a cool remains off before restarting. Range: 0 – 999. Default: 0. Set the time to 0 for continuous operation.
- **Minimum Off Time:** Define the minimum amount of time that a cool remains off before restarting. Range: 0 – 999. Default: 0

6. Define the Set Definitions.

4.2.2.3 Cool Pad Help | Set Definitions

② While viewing the Cool Pad menu: Press **HELP**, select **SET** and press **ENTER**.

SYSTEM PARAMETERS	
COOL PAD	
Enable Cooling From Time	0:00
Enable Cooling To Time	0:00
Ramping Temperature Range	20.0
Humidity % to Stop Cooling	100
Humidity Band (%)	5
COOL PAD FLUSH	
Flush Cool Pad At:	0:00
Cool Pad Flush Duration (minute)	0

• Define:

- **Enable Cooling From/To Time:** Define the hours between which cooling pads can operate. Range: 00:00 – 23:59. Default: 00:00 (always enabled)
- **Ramping Temperature Range:** Define the maximum temperature at which ramping takes place. Ramping takes place between the On Temperature (+ 0.5°) and this point. For example if cooling begins at 75° and the ramping range is 10°, ramping continues until the temperature reaches 85.5°. Range: 0 – 36° F/0 – 20° C. Default: 36°/20°.

- **Humidity % to Stop Cooling:** Above this level, cooling ceases. Range 0 – 100%. Default: 100%.

NOTE As cool pads operate, the humidity can rise to the level that causes cool pads to stop operating.

- **Off Humidity Band:** Define the drop in humidity that must occur before cooling restarts (after cooling ceases because of high humidity). Range: 0 – 20%. Default: 5%

Cool Pad Flush

- **Flush Cool Pad At:** Set time of day (hh:mm) to start continuous water application to remove deposits from the cool cells. If flushing occurs during a ramping cycle, the cool pad operates continually until flushing ceases; at the point ramping restarts.
- **Cool Pad Flush Duration (minutes):** Set the length of time in minutes for flushing. If this parameter is set, flush is applied without regard to ventilation level or operating mode.

4.3 Foggers

- Foggers Main Screen
- - Help | Set Definitions

4.3.1 FOGGERS MAIN SCREEN

This menu sets the operating conditions for the Foggers.

NOTE Foggers and cooling pads operate according to the same parameters.

Day	Start Time	End Time	On Temp Diff	To Hum	On sec	Off sec
5	12:00	21:00	0.0	99	300	600
20	12:00	21:00	0.0	99	300	300
0	00:00	00:00	0.0	0	0	0
0	00:00	00:00	0.0	0	0	0
0	00:00	00:00	0.0	0	0	0
0	00:00	00:00	0.0	0	0	0
0	00:00	00:00	0.0	0	0	0
0	00:00	00:00	0.0	0	0	0
0	00:00	00:00	0.0	0	0	0
0	00:00	00:00	0.0	0	0	0

1. In *Installation > Relay Layout*, define a relay(s) as fogger.
2. In *Device > Foggers*, define the parameters below.
3. In *Device > Temp & Timer Settings*, scroll to each fogger.
4. Under Option, select Prog.

NOTE To enable this screen, you must select Prog.

5. Set the Help parameters as required.
 - **Day:** Set growth day
 - **Start Time & End Time:** Time of day you want foggers to start and stop.

- It is possible to set multiple start and stop times for a single day.
- In the screen above, the first programmed line is at day 47. The foggers do not operate before growth day 47 in this case. Since there are no entries other than day 47, the day 47 program lines apply from then on.
- **On Temperature Difference:** Set difference from tunnel temperature to use this setting. You can use negative differential temperatures.
 - Note the settings for Day 14. Platinum Pro/Rotem Pro uses the maximum temperature differential that applies to choose the correct settings.
- **To Humidity:** Set maximum humidity allowed before stopping foggers.
- **On Sec:** Set the maximum on time for each cycle of fogger operation.
- **Off Sec:** Set the minimum off time for each cycle of fogger operation.

4.3.2 FOGGERS HELP | SET DEFINITIONS

② While viewing the Foggers menu: Press **HELP**, select **SET**, and press **ENTER**.

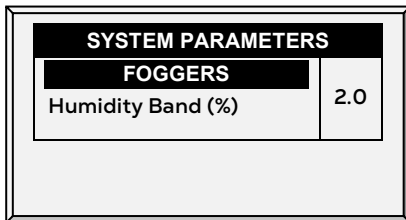

- **Humidity Band (%):** Define the on/off hysteresis relative to humidity.

4.4 Water & Feed

- Water & Feed Main Screen
- 108BWater and Feed Help | Set Definitions

4.4.1 WATER & FEED MAIN SCREEN

This menu sets the operating conditions for water and feed devices.

WATER & FEED							
Day	Time hh:mm	Water		Feeder		Auger	
		1	2	1	2	1	2
1	00:00	✓	▪	✓	▪	✓	▪
12	10:00	✓✓		✓✓		✓	▪
25	14:00	✓✓		✓✓		▪	✓
46	00:00	✓✓		▪	▪	▪	▪
48	00:00	▪	▪	▪	▪	▪	▪
0	00:00	▪	▪	▪	▪	▪	▪
0	00:00	▪	▪	▪	▪	▪	▪
0	00:00	▪	▪	▪	▪	▪	▪
0	00:00	▪	▪	▪	▪	▪	▪
0	00:00	▪	▪	▪	▪	▪	▪

1. Go to Installation > Relay Layout.
2. Define the relays as required.
3. Go to Device Setting > Water and Feed.

4. Define the parameters.

- **Day:** Set growth day. You can define days as negative days. Enter the number and then press the +/-key.
- **Time:** Set event times for water, feeder, or auger. Check marks indicate ON at the event time, and dots indicate OFF. Toggle between check marks and dots with the +/- keys.
- **Water:** Select a check mark to mark water lines to turn on, dot the ones to turn off.
- **Feeder:** Check mark feed lines to turn on, dot the ones to turn off.
- **Auger:** Check mark auger lines to turn on, dot the ones to turn off.

NOTE You can implement mealtime, clean up meals and other options similarly as shown earlier in the light programs.

4.4.2 WATER AND FEED HELP | SET DEFINITIONS

These parameters define the feed and water delivery schedule through the week.

NOTE The Water and Feed parameters work in conjunction with the Lighting parameters.

- **Daily:** Same schedule for every day of the week.
- **2 – 6 Days:** Select a cycle that lasts the number of days chosen and then repeats itself. For example, 2 Days means that the cycle lasts two days and then repeats itself.

SYSTEM PARAMETERS			
WATER & FEEDS		2 DAYS	
Feed Day Cycle			
DAYS CYCLE			
Day:	1	2	
Feed:	√		
WATER ON NO FEED DAYS			
Start	Stop	Start	Stop
10:00	10:30	11:30	12:30

- **Week:** Select which days in the week that feed and water are delivered.

SYSTEM PARAMETERS							
WATER & FEEDS						WEEK	
Feed Day Cycle							
DAYS CYCLE							
Day:	SUN	MON	TUE	WED	THU	FRI	SAT
Feed:	√		√	√		√	
WATER ON NO FEED DAYS							
Start	Stop		Start	Stop			
10:00	10:30		11:30	12:30			

NOTE If you choose Daily, the Scale function is always enabled. If you choose 2- 6 Days or Week, the Scale function is disabled on non-feeding days.

NOTE If you want to provide feed every day, select Daily. Selecting Week and marking each day, causes problems with this function.

If you select the 2 – 6 Day schedule or the Week schedule, configure:

- **Days Cycle (2 – 6 Days):** Select which days in the cycle that feed and water is delivered.
- **Week Cycle:** Select the days that feed and water is delivered.
- **Water on No Feed Days:** Select up to two time periods when water is delivered on non-feed days.

NOTE On feed days, water is delivered when feed is delivered.

4.5 light

- Light Main Screen
- Light Help | Set Definitions
- Light Measurement Control

4.5.1 LIGHT MAIN SCREEN

This menu sets the operating conditions for lights. The controller has a capacity for up to four channels of *On/Off Lights* and up to four channels of *Dimmer Lights*.

LIGHT						
Day	Time	Light			Intensity (%)	
		1	2	3	1	2
1	00:00	✓	✓	■	100	0
12	00:00	✓	■	✓	45	45
12	01:00	■	■	■	0	0
12	03:00	✓	■	✓	45	45
12	21:00	■	■	■	0	0
25	00:00	■	■	■	0	0
25	03:00	■	■	■	35	35
25	20:00	■	■	■	0	0
25	23:00	■	■	■	35	35
0	00:00	■	■	■	0	0

The configuration of this menu is dependent on the Water and Feed Help | Set Definitions (page 41) configuration:

- If you select Daily, the above screen appears when you select Light; configure the Light menu once.
- If you select 2 – 6 Days or Week, the screen below appears.

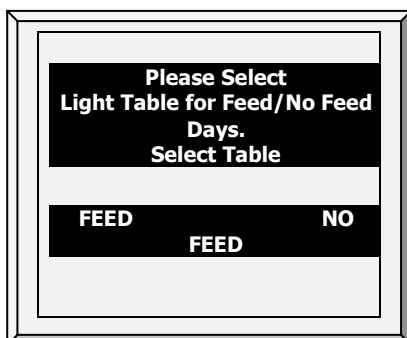

1. Select **Feed** and press **Enter**. The Light parameters screen appears. These parameters configure the Light functions on feed days.
2. Configure the parameters.
3. Select **No Feed** and press **Enter**. The Light parameters screen appears. These parameters configure the Light functions on non-feed days.
4. Configure the parameters.

- **Day:** Set Growth Day

In the example, the brood lights (channel 1) and bright center lights (channel 2) turn on from day 1, while the grow end lights (channel 3) are off. The example shows two channels of light dimmer, Channel 1 at 100% and Channel 2 at 0% (for baby chicks in the brood zone).

- **Time:** Set event times for the lights.
 - On day 12, the center lights turn off, and the dimmer lights go to 45%. There are two periods of darkness: from 01:00 to 03:00 in the morning, and 09:00 PM to midnight. This program repeats until day 25.
 - From day 25 the on/off lights stay off, and the dimmer lights provide dim light during the on periods and go out fully for two periods of darkness. The dark periods total 6 hours, being from midnight to 03:00 AM and from 08:00 PM (20:00) to 11:00 PM (23:00).
- **Light:** Check mark the desired light(s) you would like to turn on. Apply dots for lights you would like to turn off. Switch between check marks and dots by pressing the +/- key.
- **Intensity (%):** Set intensity in percentage for light dimmer(s). Dimmer lights start to brighten if the intensity increases, and complete dimming if the intensity decreases at the set time. That is, they start dimming the 'sunset time' in advance of the set time (see **Help | Set** below).

4.5.2 LIGHT HELP | SET DEFINITIONS

② While viewing the Light menu: Press **HELP**, select **SET**, and press **ENTER**.

DEVICE SETTING	
LIGHT	
Sunrise Time (minutes)	0
Sunset Time (minutes)	0
Allow Spiking from Day	0
Spike Cycle (minutes)	0
Spike Duration (minutes)	0
Spike Increase Amount (%)	0
Signal Light Is:	LIGHT2
Signal Before Feed (seconds)	60
Signal During Feed (seconds)	60
Light Sensor Active	

- **Sunrise Time (minutes):** The amount of time required for the light intensity to rise from 0% to the designated level.
- **Sunset Time (minutes):** The amount of time required for the light intensity to decline from the designated level to 0%.
- **Allow Spiking from Day:** The day spiking begins.

- **Spike Cycle (minutes):** The time length that the spike is at its maximum level. Reaching the maximum level and returning to the preset level both take one minute. For example if the spike duration is 10 minutes, the spike cycle is 8 minutes.
- **Spike Durations (minutes):** The total amount of time of the spike cycle, including the rise and fall times.
- **Spike Increase Amount:** Set the increase in intensity for the spike in relation to the current light intensity.
- **Signal Light Is:** Only one light operates during feeding times. Select which light is lit or choose "None".

NOTE After the feeding period ends, all lights selected in the Light Parameters screen relight.

- **Signal Before Feed (seconds):** Amount of time, before the feeding starts, that all other lights go off.
- **Signal During Feed (seconds):** Amount of time that the selected light remains on after feeding ends.

NOTE The above two parameters are disabled on no feed days.

- **Light Sensor Active:** The light sensor turns off all lights when sufficient outside lights exist (refer to Light Sensor Calibration, page 89). If a light sensor is installed, enable this option to turn off the light during feeding time when there is sufficient outside light.

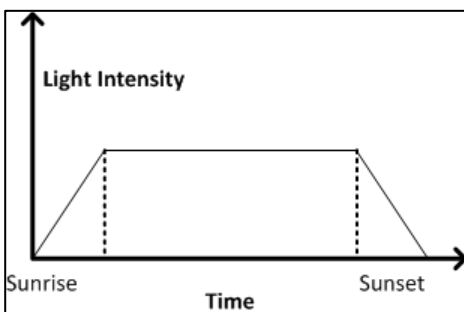

Figure 4: Lighting without Spiking

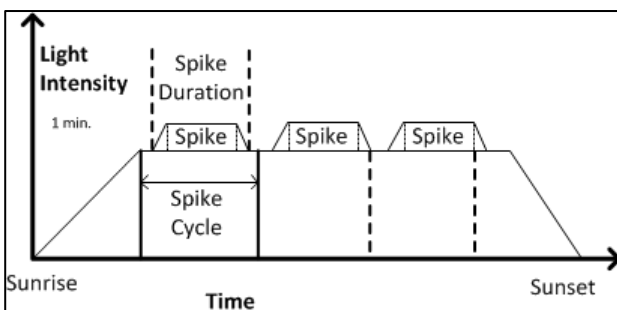

Figure 5: Lighting with Spiking

NOTE The initial reference time for the Spike Cycle is the end of Sunrise. The spike begins Spike Duration minutes before the end of the Spike Cycle and has one minute up and down ramps in intensity. If Sunrise Duration is set to zero, no spiking occurs.

4.5.3 LIGHT MEASUREMENT CONTROL

Version 6.20 supports employing a LUX light sensor to control the light intensity. In this function, the Target LUX is the defined light intensity target. The controller measures the light intensity in LUX values and adjusts the output accordingly.

- On/OFF Light Function does not operate when using Light Dimming by LUX.
- Sunrise/Sunset functions does not operate when using Light Dimming by LUX.

To configure light measurement:

1. In Install > Analog sensor, define a sensor as Light 0 – 40 LUX.
2. Go to Device > Light. Target LUX only appears if a sensor is defined.

LIGHT					
Day	Time	Target LUX	Light		
			1	2	3
1	00:00	50			
12	00:00	40	✓	✓	■
12	01:00	40	✓	■	✓
12	03:00	50	✓	■	✓
12	21:00	50	■	■	■
25	00:00	40	■	■	■
25	03:00	40	■	■	■
25	20:00	50	■	■	■
25	23:00	0	■	■	■
0	00:00	0	■	■	■

2. Go to Device > Light > Settings.

2. Define:

- LUX Band (LUX): No change in light output takes place while the measured amount of light is within this band (percentage). Default 2. Range 2 – 10.
- Increase Interval Time (sec): The interval time for the light intensity to increase (by 1%) from the previous change. Default. Range 0 – 120.
- Decrease Interval Time (sec): The interval time for the light intensity to decrease (by 1%) from the previous change. Default. Range 0 – 120.

2. Set the [Low Light Alarm Enabled alarm](#), page 63 (optional).

4.6 Extra Systems

This menu is for setting the parameters of the other devices that are not listed in the controller.

EXTRA SYSTEMS				
System	1	2	3	4
Start Time	10:30	06:15	14:20	00:00
End Time	18:45	20:30	03:15	00:00
From Temp	75.5	85.5	60	0.0
To Temp	93.0	95.5	98.0	0.0
From Hum.	55	60	60	0
To Hum.	85	85	85	0
On (sec)	45	45	300	0
Off (sec)	300	300	2000	0

- **Start Time:** Time at which this Extra System starts.
- **End Time:** Time at which this Extra System stops.
- **From Temp:** Temperature above which Extra System operates.
- **To Temp:** Temperature below which Extra System operates.
- **From Humidity:** Humidity above which Extra System operates
- **To Humidity:** Humidity below which Extra System operates.
- **On (sec):** On time for the Extra System. If set to 0, the extra system does not operate.
- **Off (sec):** Off time for Extra System after completion of on time. If you have values in both ON and Off, the extra system cycles. If you have zero OFF time, and any ON time, the system simply stays on as long as the other parameters are satisfied.

NOTE All parameters must be satisfied for an Extra System to operate. If the temperature is below the From Temperature or the Humidity below the From Humidity for example, the system is OFF. You can assign specific temperature sensors to an Extra System in [Install | Temp Definition](#). The Extra System uses the Inside Humidity, not the Outside Humidity. If there is no humidity sensor, the Extra Systems ignore the humidity parameters.

4.7 Variable Speed Fan Setting

- Variable Speed Fan Main Screen
- Variable Speed Fan Help | Set Definitions

4.7.1 VARIABLE SPEED FAN MAIN SCREEN

This section details the configuration procedure.

➤ This function requires an Analog Output card in the controller.

1. In *Installation > Analog Output*, configure:
 - a. analog outputs as variable speed fans.
 - b. the minimum and maximum voltage output for each fan.

ANALOG OUTPUT				
Output Number	Function	No.	Min V. Out	Max V. Out
1	Tunnel Fan	1	0.0	0.0
2	Tunnel Fan	3	0.0	10.0
3	Exhaust Fan	3	0.0	10.0
4	Stir Fan	1	0.0	0.0
5	<None>			
6	<None>			
7	<None>			
8	<None>			

2. In *Device > Variable Speed Fans Setting*, set the following parameters (refer to Figure 7):

VAR. FAN#	Min	Max
Tun.Fan3	30	100
Exh.Fan3	30	100
3	30	100
4	30	100

- Min: The minimum fan speed/analog output (in percentage)
- Max: The maximum fan speed/analog output (in percentage)

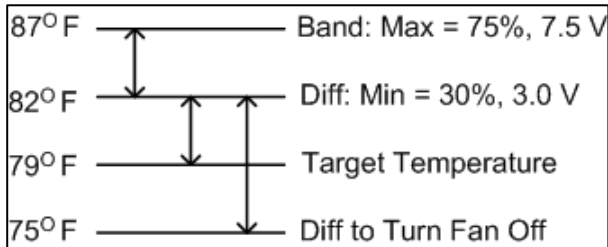

Figure 6: Variable Speed Fan Example

3. Set the Help parameters as required.
4. In Device > Tem & Timer Settings, scroll to MT.
5. Enable M and/or T as required.
6. Under Option, select the on/off schedule:
 - Min.V: When in minimum ventilation, fans run on the schedule defined in Control > Minimum Vent Timer.
 - ----: When in minimum ventilation, fans run continually.

4.7.2 VARIABLE SPEED FAN HELP | SET DEFINITIONS

- ① While viewing the V. SPD Fans Setting: Press **HELP**, select **SET**, and press **ENTER**

SYSTEM PARAMETERS	
V. SPEED SETTING	
Diff to Turn Fan Off	-36.0
Day to Disable Fan Off	0

- Diff to Turn Fan Off. If required, the variable fan can operate at minimum ventilation below the Target Temperature. This parameter configures the temperature below the Target Temperature at which ventilation runs at minimum. In Figure 7, the F. MV Off is 7° F. Default is 0° F
- Day to Disable Fan Off: The growth day at which the variable speed fan ceases to operate

4.8 Water on Demand

The Water on Demand (WOD) function enables regulating the pressure of all nipple lines in the house from one central point, ensuring uniform pressure in all lines. The function also enables immediate transitioning between different preset pressures of all nipple lines in the house by closing and opening of valves at the central point (manual or solenoid according to the mode installed).

Platinum Pro/Rotem Pro enables controlling the water cycle times using relays and controlling the water pressure using analog input and output sensors. The two methods are complimentary. A user can use either one alone or both.

- Relay Control
- Sensor Control

NOTE The two methods are complimentary.

4.8.1 RELAY CONTROL

You can specify up to 50 time periods.

WATER ON DEMAND		
Day	Time hh:mm	WOD-RLY
		1 2 3 4
1	12:00	✓ ● ✓ ●
2	6:00	✓ ✓ ✓ ●
3	8:00	✓ ✓ ✓ ●
5	10:00	✓ ✓ ✓ ●
7	12:00	✓ ● ✓ ●
9	14:00	✓ ● ✓ ●

1. In *Installation > Relay Layout* designate up to four relays as WOD valves (relays 179 to 182). Refer to page 102 for details.

2. In *Device > Water on Demand*, configure the following parameters:

- **Day:** Specifies the day to activate the selected WOD valve. You can define days as negative days. Enter the number and then press the +/-key.
- **Time:** Specifies the time to activate the enabled valves. The valves continue running until the next scheduled day and time.
- **WOD Relay:** Enable the required relays

3. Set the WOD alarms in - *Setting Help | Set Definitions*, page 61.

4.8.2 SENSOR CONTROL

NOTE When using sensor control, WOD status appears on the Main Screen, Hot Screen 7, and Hot Screen 0.

WATER ON DEMAND				
Day	From Time hh:mm	To Time hh:mm	WOD	Press IN. W.C
1	12:00	14:00	1	30.00
2	12:00	14:00	2	20.00
3	12:00	14:00	3	15.00
5	12:00	14:00	3	10.00
7	12:00	14:00	4	10.00
9	12:00	14:00	4	5.00

To add precision measurements:

1. To control the water valve opening, In *Installation* > *Analog Output*:
 - a. designate one output device as Water on Demand Precision.
 - b. set the minimum input and output voltages.
2. In *Installation* > *Analog Sensor*, designate one sensor as Water of Demand Pre. This setting enables a sensor to measure the water flow.
3. In *Device* > *Water on Demand*, configure the following parameters:
 - **Day**: Specifies the day to activate the selected WOD valve. You can define days as negative days. Enter the number and then press the +/-key
 - **.From Time/To Time**: Specifies the time to activate and deactivate the specified required pressure.
 - **Pressure**: Specifies the required water pressure. The unit that appears is the unit defined in *Installation* > *Setup* (pressure unit) (page 101).
4. In *Device* > *Water on Demand* > *Help* set the parameters (optional).
5. In *Service* > *WOD Calibration*:
 - a. Enter the first pressure and voltage data points.
 - b. Repeat for second data point.
 - c. Set the Help definitions (optional, refer to WOD Calibration Help | Set Definitions, page 100).
6. Set the WOD alarms in - *Setting Help* | *Set Definitions*, page 61.

4.8.3 WATER ON DEMAND HELP | SET DEFINITIONS

SYSTEM PARAMETERS	
WATER ON DEMAND – NIPPLE FLUSH	
Water Pres. During Flush:	0
Relay Active During Flush:	0

- **Water Pressure During Flush**: Designate the system water pressure when nipple flush is operative.
- **Relay Active During Flush**: Designate which WOD relays remain active during flushing.

4.9 Feed Scale Program

Feed Scale enables mixing different types of feeds from (up to) four different silos. The user fills each bin with the required feed type and sets the mixture ratios and quantities in Platinum Pro/Rotem Pro. The augers then distribute the feed as defined.

This screen defines:

- the total quantity of feed to be delivered to the birds
 - the auger feed mixture.
1. In *Install* > *Relay Layout* (page 102), define relays as augers as required.
 2. In *Management* > *Bird Inventory* (page 57), enter the number of birds.
 3. In *Scale* > *Scale Layout*, map the feed scales.
 4. Go to *Device* > *Feed Scale Program*.

FEEDING SCALE PROGRAM						
Day	Feed Per Bird	Silo (%)				Total Feed
		1	2	3	4	
1	0.200	70.0	10.0	10.0	10.0	4000
5	0.300	56.0	22.0	11.0	11.0	6000
12	0.400	0.0	0.0	0.0	0.0	0
20	0.300	0.0	0.0	0.0	0.0	0
0	0.000	0.0	0.0	0.0	0.0	0
0	0.000	0.0	0.0	0.0	0.0	0
0	0.000	0.0	0.0	0.0	0.0	0
0	0.000	0.0	0.0	0.0	0.0	0
TODAY						
		687	293	20		3636

5. Define:

- **Day:** Define the days at which the feed per bird changes. Platinum Pro/Rotem Pro calculates a feed curve based on these days and the feed per bird parameter. You can define the days as negative days. Enter the day number and press +/-.
- **Feed per Bird:** Define the amount of feed per bird/pigs (kilograms) to be distributed. Platinum Pro/Rotem Pro calculates the total amount of feed to be distributed based on this parameter and the Bird Inventory parameters.
- **Silo (%):** If there is more than one silo supplying feed, enter the percentage of the feed package that each silo supplies. Note that by default, Silo 1 supplies 100% of the feed. Any number entered in Silo 2, 3, or 4 is subtracted from Silo 1.
- **Total Feed:** Displays the amount of feed required for that day. This amount is calculated by multiplying the feed per bird by the number of birds in the bird inventory (taking into account any birds culled, died, or moved).
- **Today:** These numbers display the actual amount of feed required for the current growth day. In the example shown above, the growth day is Day 2. Platinum Pro/Rotem Pro calculates the curve from Day 1 to Day 5 and adjusts the numbers accordingly.

4.9.1 FEED SCALE HELP | SET DEFINITIONS

FEED SCALE SETTINGS	
Time [hh:mm]	00:00
Max Portion Weight	25
Max Auger Time [min]	10
Not Empty Time [min]	5
Stop Diff 1 Weight	2.2
Stop Diff 2 Weight	2.2
Stop Diff 3 Weight	2.2
Stop Diff 4 Weight	2.2
Optimizer	Default
Valve Close Time [sec]	5
Feed Tare [A/D count]	0
Operating Mode	AUTO
Feed Rate Update Mode	AUTO
Feed Rate 1 [Weight/Min]	0.0
Feed Rate 2 [Weight/Min]	0.0
Feed Rate 3 [Weight/Min]	0.0
Feed Rate 4 [Weight/Min]	0.0

- Define:
 - **Time:** What time the hopper begins distributing feed to the birds or animals.
 - **Maximum Portion Weight:** Enter the feed scale container size.
 - **Maximum Auger Time [minutes]:** This parameter sets an alarm for the auger running time. Enter the number of minutes that the auger can run, after which an alarm appears on the Main Screen.
 - **Not Empty Time [minutes]:** This parameter sets an alarm for the feed scale container. The container should distribute all its feed to the feed lines. If feed remains in the container, it could mean that there is a problem (for example, the valve doesn't open). Set the amount of time that feed can remain in the container, after which an alarm appears on the Main Screen.
 - **Stop Differential 1/2/3/4 Weight:** After each silo stops supplying feed to its auger line, a certain amount of feed continues to flow. This differential compensates for this excess and ensures that only the required amount gets to the feed container. Enter the approximate amount of feed that can be found in the augers. The number does not need to be exact. In the following feed runs, Platinum Pro/Rotem Pro will correct the amount entered.
 - **Optimizer:** This parameter sets the unit's sensitivity to signal noise (caused by a variety of factors). Sensitivity plays a role as the controller stabilizes itself. Greater amounts of noise require faster optimization. To view an indication of the controller's stability, go to *Scale Menu > Test* (refer to page 61) and perform a test. If the number remains stable, slower optimization is indicated. There are three settings: Default, Slower, Faster.

NOTE Munters recommends leaving this parameter at the default level.

- **Valve Close Time [seconds]:** Set the delay in time, if any, that the valve emptying the feed scale container closes.
- **Feed Tare [A/D count]:** This specification is used for certain tests performed by a certified technician.

NOTE Munters recommends leaving this parameter unedited.

- **Operating Mode:** See the following section.

4.9.2 OPERATING MODE

Operating Mode (Version 6.22) enables:

- Stopping and resuming feeding
- Initiating a feeding at any given time.

The parameter has three modes:

- **Auto:** Feeding operates according to the programming (default).
- **Bypass:** Feeding continues even if there is a problem with valves or scales. Valves remain open and augers continue to operate until the bypass state ends. During Bypass containers are filled by time (X kilos or pounds/minute).
- **Stop:** All feeding and feeding equipment stops.

To use the Bypass Mode:

1. From the drop-down list, select Bypass.

2. Define:

- **Feed Rate Update Mode:**
 - **Auto:** The controller uses the existing parameters to determine the feed rate. Note that if the user enters numbers in the Feed Rate Parameters, the controller will override these parameters if there is a contradiction between them and the existing parameters.
 - **Manual:** The user enters the feed rate in the parameters below.
- **Feed Rate 1 – 4:** Enter the amount of feed (kilograms or pounds) to be distributed by each auger per minute.

NOTE If a [hopper sensor](#) is installed, feed flow stops if there is an overflow alarm.

4.9.3 FEED SCALE HOT SCREEN

Press "Right and Up Arrows" to view the Feed Scale Hot Screen.

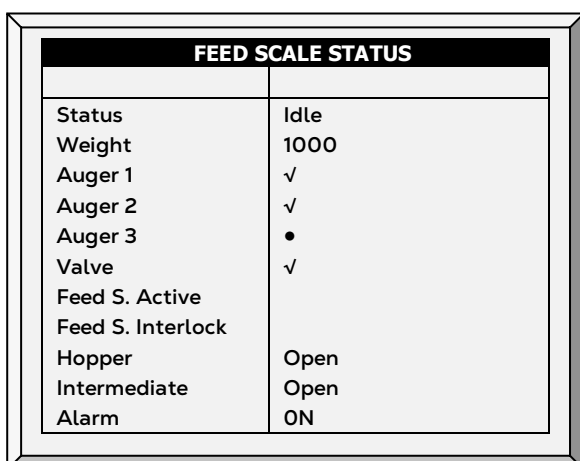

FEED SCALE STATUS	
Status	Idle
Weight	1000
Auger 1	√
Auger 2	√
Auger 3	●
Valve	√
Feed S. Active	
Feed S. Interlock	
Hopper	Open
Intermediate	Open
Alarm	ON

This screen shows the status of different areas of the feeding apparatus. illustrates the system components.

- **Status:** Shows the feed scale status: Idle, Emptying, or Filling.
- **Weight:** Shows the feed scale container weight.
- **Auger 1/2/3/4:** Shows if the auger is running (√) or closed (●)

- **Valve:** Shows if the valve emptying the feed scale is open.
- **Feed S. Active:** This field shows which controller is managing the feed scale.
- **Feed S. Interlock:** The Feed Scale Interlock is a digital sensor which detects which damper is active.
- **Hopper:** The hopper is a digital sensor which detects if the feed has reached the maximum level in the feed bin. Define this sensor in *Install > Digital Sensor*. This screen shows the sensor's current status. If the feed reaches the maximum amount, an alarm is triggered.
- **Intermediate:** The intermediate sensor is a digital sensor which detects if the feed has reached the maximum level in the feed bin. Define this sensor in *Install > Digital Sensor*. This screen shows the sensor's current status. If the feed reaches this sensor, an alarm is generated.
- **Alarm:** This parameter shows if there are active alarms. View the alarms on the Main Screen.

4.9.4 FEED SCALE HOT SCREEN

Press "Right and Up Arrows" to view the Feed Scale Hot Screen.

FEED SCALE STATUS	
Status	Idle
Weight	1000
Auger 1	✓
Auger 2	✓
Auger 3	●
Valve	✓
Feed S. Active	
Feed S. Interlock	
Hopper	Open
Intermediate	Open
Alarm	ON

This screen shows the status of different areas of the feeding apparatus. illustrates the system components.

- **Status:** Shows the feed scale status: Idle, Emptying, or Filling.
- **Weight:** Shows the feed scale container weight.
- **Auger 1/2/3/4:** Shows if the auger is running (✓) or closed (●)
- **Valve:** Shows if the valve emptying the feed scale is open.
- **Feed S. Active:** This field shows which controller is managing the feed scale.
- **Feed S. Interlock:** The Feed Scale Interlock is a digital sensor which detects which damper is active.
- **Hopper:** The hopper is a digital sensor which detects if the feed has reached the maximum level in the feed bin. Define this sensor in *Install > Digital Sensor*. This screen shows the sensor's current status. If the feed reaches the maximum amount, an alarm is triggered.
- **Intermediate:** The intermediate sensor is a digital sensor which detects if the feed has reached the maximum level in the feed bin. Define this sensor in *Install >*

Digital Sensor. This screen shows the sensor's current status. If the feed reaches this sensor, an alarm is generated.

- **Alarm:** This parameter shows if there are active alarms. View the alarms on the Main Screen.

4.9.5 FEED SCALE FUNCTIONALITY IN TWO HOUSES

Platinum Pro/Rotem Pro 6.17 enables sharing feed scale functionality between two houses. Two load cells are connected to a single feed scale. Each Platinum Pro/Rotem Pro Controller is connected to one load cell.

When the system is running, one controller operates each set of augers, feed scale valve, hoppers, and so on. A mechanical damper switches the feed supply from the scale to the corresponding hopper. Only one feed process operates at a time; when one process is running the second is in standby.

- Each hopper auger is managed by a separate feed sensor, installed in the last dish in the last feed line in each house.
- Both Platinum Pro/Rotem Pro units are connected to a single feed scale container.
- Contactors connected to the silo augers determine which house is active.
- Each Platinum Pro/Rotem Pro controller is connected to a separate hopper sensor, which indicates when the hopper is filled.
- Important: Each Platinum Pro/Rotem Pro Controller transmits the Feed Scale State to the second controller, via the Feed Scale Active Relay. This relay prevents a controller from assuming control of the Feed Scale when the latter is active. Controller 1 will release control if:
 - One of the following is true:
 - The hopper sensor shows the hopper to be filled
 - The feed cycle is complete.
 - In addition, if an Auger Overtime alarm is generated, control is transferred to the other Platinum.
- Hot key (see Feed Scale Hot Screen)

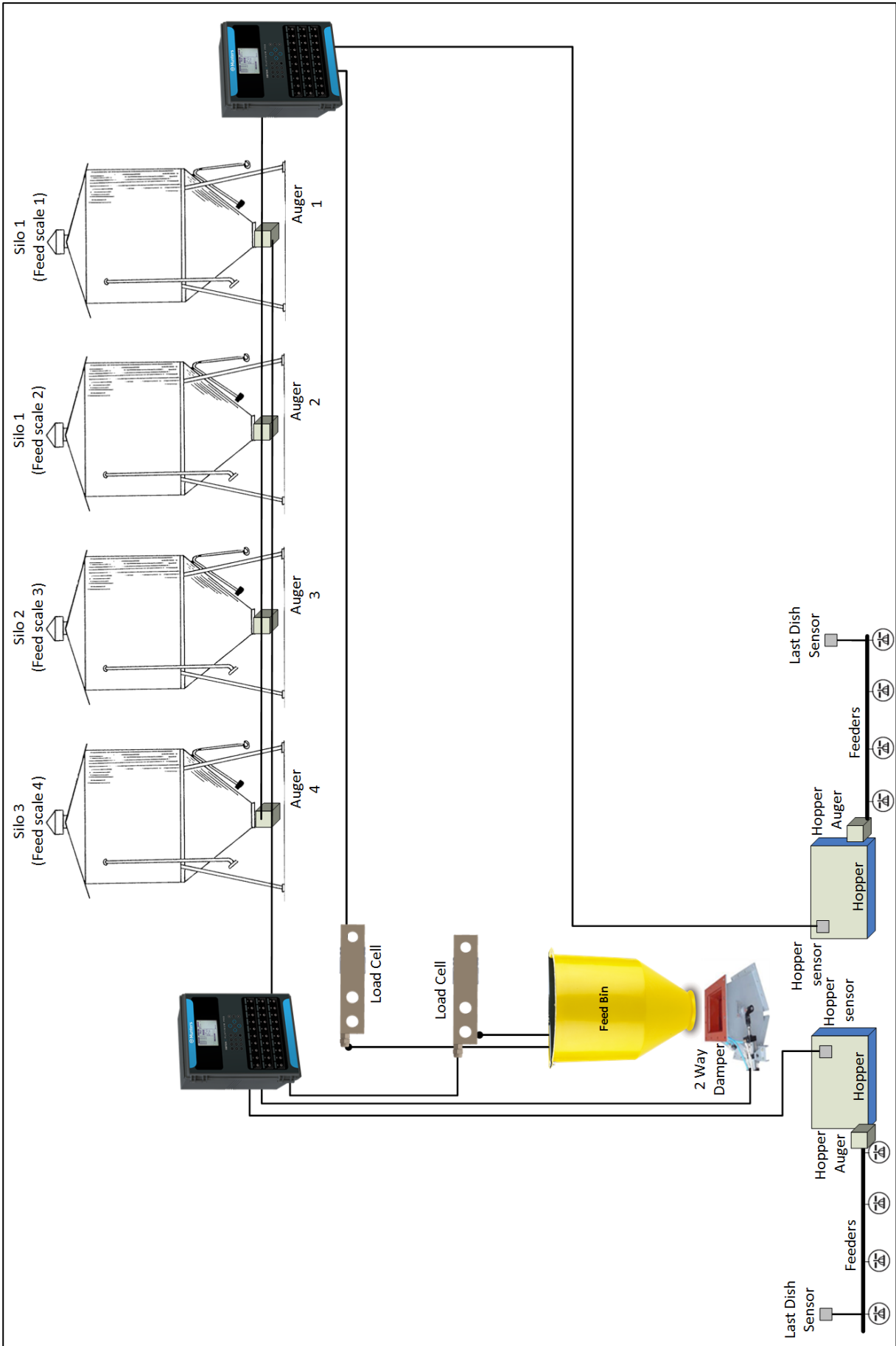

Figure 7: Feed scale block diagram

To set up the Feed Scales:

➤ Refer to the Installation manual on wiring the Controllers to the Feed Scale and Load Cells.

1. Go to *Install > Relay Layout*.
2. Define a relay as Feed S. Active.

RELAY LAYOUT			
Relay	Function	Num	NO/NC
1	Vent Open	1	-
2	Vent Open	2	-
3	Vent Close	1	-
4	Vent Close	2	-
5	Heat	1	-
6	Feed. S. Active	1	-
7	Curtain Open	1	-
8	Curtain Close	1	-
10	< None >	9	< None >
N.O. Relay			

3. Go to *Install > Digital Sensor*.
4. Define one sensor as Hopper Sensor and one sensor as Feed Scale Interlock.

DIGITAL SENSORS		
In	Function	Num
1	Hopper Sensor	1
2	Feed Scale Interlock	1
3	Cool Pad Water Meter	1
4	Fogger Water Meter	1
5	Water Meter	2
6	< None >	0
7	< None >	0
8	< None >	0

5 Management Menu

This section details the Management Menu.

- Bird Inventory, page 57
- Feed Inventory, page 58
- Time & Date, page 59
- Growth Day & Flock, page 59
- Alarm Setting, page 59
- Alarm Reset, page 64
- Fail Safe Setting, page 65
- Password, page 65
- Relay Current, page 66
- RDT-5 / Temperature Curve, page 67

MANAGEMENT
1. BIRD INVENTORY
2. FEED INVENTORY
3. TIME & DATE
4. GROWTH DAY & FLOCK
5. ALARM SETTING
6. ALARM RESET
7. FAIL SAFE SETTING
8. PASSWORD
9. RELAY CURRENT

5.1 Bird Inventory

Maintain your bird inventory by entering data into the controller.

BIRD INVENTORY			
	Male	Female	Total
Add Dead Birds	0	0	0
Add Culled	0	0	0
Birds Moved	0	0	0
Birds Placed	10000	5000	15000
Today's Dead Birds	35	33	68
Today's Culled	12	10	22
Total Dead Birds	35	33	68
Total Culled	12	10	22
Total Birds Moved	1020	510	1530
Bird Count	8933	4447	13380

- Maintain bird inventory by entering quantities in the upper half of the screen. There are separate columns for male and female. If you do not wish to keep separate data, simply enter the data into one or the other.
- Initially, enter the number of birds placed. Thereafter, enter the quantity found dead, culled (Add Culled) or moved as needed. The Platinum Pro/Rotem Pro shows totals and subtotals in the lower portion of the screen.
- You can correct an error, so long as you correct it on the same day before midnight, by entering a negative quantity (press the +/- key after the number) to subtract the error. After midnight, the information transfers to the HISTORY Menu.

5.2 Feed Inventory

- Feed Inventory Main Screen
- - Inventory Help | Set Definitions

5.2.1 FEED INVENTORY MAIN SCREEN

Maintain your feed inventory by entering data into the controller.

FEED INVENTORY					
No.	Date	Silo			
		1	2	3	4
1	2-Jan-12	7800	0	0	0
2	5-Jan-12	0	9000	15000	10000
3	13-Jan-12	8000	0	0	0
4	- -	0	0	0	0
5	- -	0	0	0	0
6	- -	0	0	0	0
7	- -	0	0	0	0
8	- -	0	0	0	0
Total Feed:		1580	9000	15000	10000

To enter feed inventory manually:

1. Type the day of the month and press **ENTER**.
2. Select the month and press **ENTER**.
3. Type the two-digit year and press **ENTER**.
4. Enter the quantity under the Silo.
5. To delete an entry, change the quantity to zero for both feed bins and press **ENTER**. Exit the menu and the entry disappears when you enter the menu again.

If you have installed load cells and connected feed bin scales to your Platinum Pro, it automatically maintains feed inventory, including delivery dates and feed consumption data. You can monitor your fill system and maintain approximate feed inventory using the [Digital Inputs](#). In this case, you need to enter your own delivery dates.

This information transfers to the *HISTORY > Water & Feed* menus daily, and optionally as often as selected (by the minute) in History View.

5.2.2 FEED INVENTORY HELP | SET DEFINITIONS

SYSTEM PARAMETERS	
FEED INVENTORY	
Total Feed In Silo-1	0
Total Feed In Silo-2	0
Total Feed In Silo-3	0
Total Feed In Silo-4	0
Active Feed Bin	▶ F.BIN1

- Total Feed in Bin-1-4: Manually change or correct the amount of feed in the bins.
- Active Silo: Select the required silo for use. It is possible to select all.

5.3 Time & Date

This menu sets the current time and date for the controller.

TIME & DATE	
Current Time	09:19
Date	10-Mar-08
Day of the Week	▶ SUNDAY

- **Current Time:** Enter the current time using a 24-hour format.
- **Date:** Enter the date in day-month-year format.
- **Day of the Week:** Select the day of the week from the drop-down menu.

5.4 Growth Day & Flock

This menu defines the number of growth days and flock number.

Growth Day & Group	
Current Growth Day	27
Group No.	1
New Group	▶ NO

- **Current Growth Day:** Enter current growth day, if necessary. It is possible to enter negative growth days up to -2. If you reset the growth day for a new flock using this tool, your old history data does not clear. Use New Flock function to clear out old history in preparation for new birds.
- **Flock No.:** The controller automatically increments the flock number each time you choose New Flock. You can edit the flock number. Since this field accepts six digits, some producers enter a flock number that is made of the day, month, and year the birds arrived.
- **New Flock:** Use the new flock function on arrival of a new set of birds to set the growth day back to 1, 0, -1, or -2, and to clear out old history data.

5.5 Alarm Setting

- Alarm Settings Main Screen
- Alarm Setting Help | Set Definitions
- Prioritizing Alarms

5.5.1 ALARM SETTINGS MAIN SCREEN

This menu defines the various alarm settings.

ALARM SETTING	
Global Alarm Delay (sec)	1
Alarm Reminder (min., 0-Disable)	30
SENSOR ALARM	32.0
Sensor Low Temp. Range	122.0
Sensor High Temp. Range	1.0
Sensor Alarm-Diff From Lo. Alarm	1.0
Sensor Alarm-Diff From Hi. Alarm	12:00
ALARM	DAILY
Alarm Test At Time: (hh:mm)	0
Day Of Alarm Test: <input type="checkbox"/>	15
Alarm Test Duration (sec)	
AUGER OVERTIME ALARM	

NOTE See Fail Safe Setting, page 65.

- **Global Alarm Delay (sec):** Alarms without a separate alarm delay, use this global delay before signaling the alarm.
- **Alarm Reminder (min., 0-Disable):** Set a reminder after a period of time in minutes if the situation has not yet been corrected.

Sensor Alarm

- **Sensor Low Temperature Range:** Sets the minimum reading a sensor can have to be considered a valid sensor reading. Sensor readings below this are rejected. This generates a sensor out of range alarm. This does not apply to the special Circuit Breaker Sensor or Outside Temperature Sensor.
- **Sensor High Temperature Range:** Sets the maximum reading a sensor may have to be considered a valid sensor reading. Sensor readings above this reading are rejected. This generates a sensor out of range alarm. This does not apply to the special Circuit Breaker Sensor or Outside Temperature Sensor.
- **Sensor Alarm-Differential from Low Alarm:** Individual sensor (or zone) alarm if any active sensor reads this much or more below the [Control | Temperature Curve | Low Alarm Temperature](#).
- **Sensor Alarm-Differential from High Alarm:** Individual active growth area sensors alarm if they read this much or more above the [Control | Temperature Curve | High Alarm Temperature](#).

Alarm

- **Alarm Test at Time:** Schedule an alarm test at a particular time.
- **Day of Alarm Test:** Choose Daily or a particular day of the week for the scheduled alarm.
- **Alarm Test Duration (sec):** Choose a specific duration for the Alarm Test.

Auger Overtime Alarm

- **Auger Overtime Delay (minute):** Set the maximum auger run time for your cross-fill system. If you have a monitor connected to the digital inputs programmed as

Feeder-1 Overtime or Feeder-2 Overtime the Platinum Pro/Rotem Pro sends an alarm after this delay.

- **Feeder Off During Overtime:** Choose whether to shut the feed systems off after a feeder overtime alarm. Options:
 - **No:** All augers and feeders remain on.
 - **All:** All augers and feeders shut down.
 - **Related:** Only the specific auger from which the alarm originated and its feeders shut down.

NOTE If you choose All or Related, the feed system turns off, and does not resume until activating [Reset Alarm](#) in the Management Menu.

Feeder Overtime Alarm

- **Feeder Overtime Delay:** Set the maximum feeder run time for your cross-fill system. If you have a monitor connected to the digital inputs programmed as Feeder-1 Overtime or Feeder-2 Overtime the sends an alarm after this delay.
- **Feeder Off During Overtime:** Choose whether to shut the feed systems off after a feeder overtime alarm. Options:
 - **No:** All augers and feeders remain on
 - **All:** All augers and feeders shut down.
 - **Related:** Only the specific auger from which the alarm originated and its feeders shut down.

NOTE This alarm functions in the Broiler mode only.

NOTE Setting the Feeder Off During Overtime to All in either the Auger Overtime Alarm or the Feeder Overtime Alarm shuts down the augers and feeders, regardless of the other alarm's setting.

Auger Empty Alarm

- **Condition Detection Delay (sec):** Platinum Pro/Rotem Pro sends an alarm when the current goes to the level set in the following parameter after this delay.
- **Below Nominal Current (%):** Send an alarm when the nominal current drops to the level set here.

NOTE This alarm is operative only if 1) Current Sense Relays are installed and calibrated 2) augers have been calibrated.

5.5.2 ALARM SETTING HELP | SET DEFINITIONS

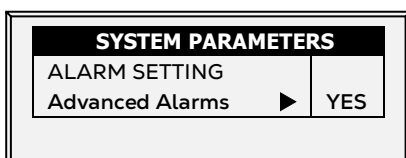

- **Advanced Alarms:** When selecting YES, the following additional alarms appear on the ALARM SETTINGS screen (press MENU and then ENTER to reenter the screen):

Water on Demand Alarms

- **High/Low Pressure Diff (PSI):** Sends an alarm when the difference between the current WOD pressure and the defined pressure reaches these levels. 0 means that the alarm is disabled.

- **Shutdown Pressure Diff (PSI):** Shuts down the Water on Demand system when the pressure reaches this level.
 - Shutdown pressure must be equal to or higher than the High/Low Pressure Difference.
 - However, to disable this alarm set it to 0 (zero), even if the High/Low Pressure is above 0.

Feed Alarms

- **Allow Feed Alarm From/To:** Set a starting time from which the controller can send feed shortage alarms.
- **Silo 1/2/3/4 Low Feed Alarm Limit:** Alarm if feed in Bin 1/2 is below this limit and time is between From and To limits.

Water Overflow Alarms

- **Overflow According to Light Table:** Change overflow alarm level when the lights are off.
- **First Day Curve for Overflow:** Overflow on the FIRST day applies to the first day operation. You can define a first day at which to start increasing the overflow limit automatically. Days prior to the 'First Day' use the First Day overflow limit; days following the first day have an incremental curve toward the LAST DAY OVERFLOW parameter setting.
- **Overflow at First Day:** Number of gallons/liters per minute that generate an overflow alarm on the first day.
- **Last Day Curve For Overflow:** Set the last day for the overflow curve.
- **Overflow on Last Day:** Overflow (Gallons/Liters) on the last day sets the maximum overflow limit will be continued after that day.
- **Overflow At Dark:** Select overflow limit. When it is dark, controller checks every minute.
- **Overflow Alarm Delay:** Define delay time before the controller generates an overflow alarm.
- **Extra Delay At Light Start:** When the first light appears, define the amount of minutes before the controller begins to operate according to the set overflow for that day.
- **Fogger Water Overflow:** Define the water overflow for foggers (per minute).

Water Shortage Alarms

- **Allow Water Shortage Alarm From/To:** Set the period for which the controller generates water shortage alarms.
 - In Version 6.23, Water Shortage Alarms are only sent during the times when the water lines are operating. Water operation times are defined in Water & Feed, page 40.
- **Shortage During Lights Off:** Select whether water shortage alarm should be disabled when all lights are out.
- **Quantity for Shortage:** Minimum flow rate that must be maintained or a water shortage alarm is generated.
- **Shortage Alarm Delay:** Minimum period of time that the shortage must extend through before generating an alarm.

Bird Scales Alarms

- **Allow Bird Scale Alarms From/To:** Set time frame for which the controller begins and ends generating alarms for the bird scale.

Auxiliary Alarms

Assign auxiliary alarms in the Install menu. Note that digital sensors, auxiliary alarm input with related relay must always match their relay status.

- **Related Relay For Aux Alarm 1/2/3/4:** Relay for Auxiliary Alarm 1/2/3/4.
- **AUX. Alarm Delay (sec):** Separate from the **Global Alarm Delay**. If there is a dry contact, the alarm is sent after the defined **AUX. Alarm Delay**.
- **Aux Alarm D.I. Contact:** Alarm contacts can operate in Normally Open or Normally Closed format. **Normally Open** relays close where energy is applied; if current is interrupted, the relay opens and an alarm is sent. **Normally Closed** relays open when voltage is applied; when current is interrupted the relay closes and an alarm is sent. By default, Auxiliary Alarms are defined as NO.

Circuit Breaker Alarm

- **Temperature for Circuit Breaker Alarm:** Set circuit breaker alarm temperature.

CO2 Sensor Alarm

- **CO2 High Level:** Set the maximum allowed CO2 level above which an alarm is sent. The alarm ceases when the humidity drops below this level. If the user acknowledges the alarm, the alarm messages temporarily cease (for the reminder time).

Humidity Sensor Alarm

- **Humidity High Level Alarm:** Set the maximum allowed humidity level above which an alarm is sent. The alarm ceases when the humidity drops below this level. If the user acknowledges the alarm, the alarm messages temporarily cease (for the reminder time).
- **Humidity Alarm Enabled:** Mark this parameter as Yes to enable the Humidity High Level alarm and the Humidity Sensor Fail alarm.

Ammonia Alarm

- **Ammonia High Level:** Set the ammonia level at which an alarm is sent.

Secondary Alarms

- **Enable Secondary Alarms:** Refer to **Prioritizing Alarms**, page 64.

Potentiometer Alarm

- **Enable potentiometer alarms**, which send an alarm when potentiometer-controlled devices fail.
 - Set the time frame **OR**
 - If the from/to times are set to 0:00 (default) the alarm is disabled.

Low Light Intensity Alarm

- **Low Light Alarm Enabled:** Alarm sent when the measured light is less than 50% of the requested LUX target.

NOTE Version 6.20 supports this alarm. It is active only when a LUX sensor is installed and the alarm is enabled. In addition, the dimmer output value must be set to maximum output for the corresponding active light program line.

Auger Under Runtime

- Auger Under Runtime (hours): Define augers as required. Define a digital sensor as Auger Overtime Sensor. If the alarm contactor does not turn on within the time defined in this parameter, an alarm is generated. (Version 6.22)

5.5.3 PRIORITIZING ALARMS

Platinum Pro/Rotem Pro 6.16 enables prioritizing alarms. When enabled:

- ventilation-related alarms are defined as critical. The main alarm relay will transmit these alarms to the device wired to the relay (for example, a dialer).
- non-ventilation alarms are defined as non-critical. A secondary relay will transmit alarms to another device (for example, an ELS).

To prioritize alarms:

1. Go to Install > Relay Layout.
2. Define a relay as Alarm (N.C.).
3. Go to Manage > Alarm Setting > Help
4. Enable Advanced Alarms.
5. Go to Manage > Alarm Setting.
6. Scroll to Secondary Alarms and define as Yes.

5.6 Alarm Reset

This menu functions as an alarm and siren reset.

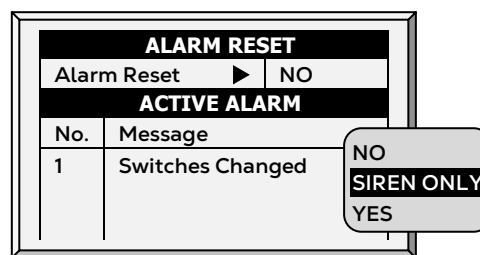

- Alarm Reset:
 - NO: Does not reset alarms
 - SIREN ONLY: Resets only the siren; alarms remain
 - YES: Resets alarms
 - Select YES to reset the alarm function:
 - Clears the alarm relay for all current alarms. The alarms may remain valid, but the unit does not register new alarms. If a new alarm occurs, or an existing alarm clears and reoccurs, the alarm relay signals again (after any appropriate delay).
 - To restore normal operation after an emergency pressure or feed overrun incident. If the controller experiences a high-pressure alarm for too long, it enters emergency pressure operation by opening all known air sources. Curtains open to preset amounts as set in [Static Pressure Help | Set](#) (page 26). If you select SIREN

ONLY, the alarm relay returns to the no alarm condition, but the emergency pressure status continues.

- To restore normal operation after a feed overrun situation that calls for turning off the feeding system. If the feed monitor senses the cross auger runs too long, it trips a feed overrun alarm and optionally turns off the feed system. If you select SIREN ONLY, the alarm relay returns to the no alarm condition, but the feed overrun status continues.

5.7 Fail Safe Setting

When there is a problem, the fail-safe function activates a backup system immediately to ensure that adequate ventilation continues. Commonly a standard relay is held normally closed by software. When the controller powers off or one of these alarms occurs, the fail-safe triggers causing the backup to take over.

FAIL SAFE SETTING	
Alarm Type	Select
High Temp.	✓
Low Temp.	•
Low Static Pressure	✓
High Static Pressure	✓
Avg. Temperature Fail	•
AUX.	•
CO2	✓

The Platinum Pro/Rotem Pro has six options besides controller failure or power off to activate the fail-safe relay. Check the additional settings to apply by using the '+/-' key:

- **High/Low Temperature:** Select to trigger fail-safe when the temperature is exceptionally high/low.
- **Low/High Static Pressure:** Select to trigger fail-safe when the static pressure is exceptionally low/high.
- **Avg. Temperature Fail:** Select to trigger fail-safe when all sensors in house fail.
- **AUX:** Select to trigger fail-safe when auxiliary dry contact occurs.
- **CO2:** Select to fail-safe when the measured CO2 levels rise above permitted levels (Version 6.24 and above).

5.8 Password

PASSWORD	
Owner Password	----
User-1 Password	----
User-2 Password	----
User-3 Password	----
User-4 Password	----
User-5 Password	----
Visitor Password	----

The owner can set new passwords for himself, all users, and the visitor. The owner cannot see user passwords once entered or changed by the users. The users can access the

controller and make changes to all controller settings and their own password. A user can see and change his password only. The visitor can access the controller but cannot make changes. Each time someone accesses the controller with a password, an event is recorded in the HISTORY [Table of Events](#).

NOTE If your controller uses passwords, the controller also requires a password entry to acknowledge switch position changes. If the switch change is not acknowledged the controller signals an alarm.

5.9 Relay Current

➡ The Relay Current feature supports single phase electricity only.

This menu configures the relay current sense parameters. You can configure:

- the minimum and maximum amperage flowing to the relays
- the relay current alarm
- voltage type

NOTE Configuring the amperage is not required. The Platinum Pro/Rotem Pro controller automatically configures default settings.

RELAY CURRENT SETTING						
Rly.	Function	Min	Nom	Max	Alr	Vlt
31	Heat 6	2.7	3.8	5.0	NO	110
32	Heat 7	2.7	3.8	5.0	NO	110
33	Heat 8	3.0	3.8	5.6	NO	110
34	Exh. Fan 5	2.7	4.3	5.0	NO	110
35	Exh. Fan 6	2.3	3.8	5.0	NO	110
36	Tun. Fan 1	3.0	4.3	5.6	NO	110
37	Tun. Fan 2	0.0	0.0	0.0	NO	110
38	Tun. Fan 3	0.0	0.0	0.0	NO	110

NOTE Calibrate the relay before configuring these parameters. Refer to Current Sense Relay Calibration, page 98. Relays that are not calibrated (or if the relay is not a Current Sense relay) do not display amperage readings (see relays 37 and 38 in the above figure).

To configure the relay current:

1. Using the arrow buttons, select a minimum or maximum amperage setting.
2. Configure the parameter as required.

NOTE The minimum amperage must be greater than the default minimum and the maximum amperage must be less than the default maximum. For example, relay 35's amperage must be more than 2.3 and less than 5.0 amps.

The Nom amperage is the parameter set when calibrating the relay (refer to page 98).

3. Configure the alarm:

- No: Alarms are not sent in the event of low or high current
- Yes: Alarms are sent in the event of low or high current
- No at zero: The controller sends an alarm if the current is low or high, but not if power is cut off entirely.

4. Configure the voltage: Select 110 or 220 volts.

5.10 RDT-5 / Temperature Curve

- Munters' RDT-5 is a five-stage digital thermostat that works in conjunction with Platinum Pro/Rotem Pro Controllers or as a stand-alone unit. When wired to the Platinum Pro/Rotem Pro, you can use the Platinum Pro/Rotem Pro to set the RDT-5's stage activation temperatures (which is easier than setting the temperatures on the RDT-T screen). The stage activation temperature determines when cooling and heating operations take place. RDT-5 supports a 10-point temperature curve.
- Version 6.20 supports two RDT-5 units.
 - If your system includes two RDT-5 units, verify that the controller identifies both in Hardware Checklist, page 85.
 - Ensure that each unit has a unique address (refer to the RDT-5 Manual for details).
 - After installing the RDT-5 units, perform a Cold Start.

RDT-5 / TEMPERATURE CURVE						
Day	Temp.	Stage 1 HEAT	Stage 2 HEAT	Stage 3 COOL	Stage 4 COOL	Stage 5 COOL
2	31.0	29.0	26.0	33.0	35.0	37.0
5	33.0	31.0	28.0	35.0	37.0	39.0
7	35.0	33.0	30.0	37.0	39.0	41.0
10	37.0	35.0	32.0	39.0	41.0	43.0

RDT-5 STAGE DIFF				
Stage 1	Stage 2	Stage 3	Stage 4	Stage 5
-2.0	-5.0	2.0	4.0	6.0

➤ Wire the Platinum Pro/Rotem Pro communication card to the RDT-5's communication card. Refer to the RDT-5 manual for details.

1. In Install > Communication, define the expansion device as Dig. Thermostat.
2. In Management > RDT-5 / Temp. Curve, define the parameters (up to a 10-point curve).

- **Day:** The growth day
- **Temp.:** The target temperature for that day.
- **Stage 1 – 5:** The temperatures at which heating or cooling starts (read only)
- **RDT-5 Stage Difference:** The differences from the target temperature at which heating or cooling starts at each stage (read only; set these numbers in the Help).

Platinum Pro/Rotem Pro automatically calculates and displays the stage activation temperatures.

CAUTION Verify that the RDT-5's growth day and the controller's growth day are the same! Days set differently means that the temperature curves will be asynchronous.

3. In RDT-5 / Temperature Curve> Set Definitions, define the parameters as required.

Notes:

- Platinum Pro/Rotem Pro does not store these temperatures; RDT-5 does. If you connect the Platinum Pro/Rotem Pro to a different RDT-5 unit, you must re-enter the temperature curve.
- If you previously defined the temperature curve in the RDT-5, Platinum Pro/Rotem Pro retrieves the data and you can edit the data in this screen.

- When connecting the RDT-5 to a Platinum Pro/Rotem Pro Controller:
 - If a Platinum Extension box is currently connected to the Platinum Pro/Rotem Pro controller, a message appears in the [Message](#) box when you disconnect the Extension box. However, no alarm is sent out.
 - After configuring the RDT-5, disconnect the unit from the Platinum Pro/Rotem Pro and reconnect the Extension box. If the Extension box is not reconnected, Platinum Pro/Rotem Pro sends out alarms.

5.10.1 RDT-5 DIGITAL ALARM

If required, define up to two digital sensors to send an alarm noting that an RDT-5 is functioning. Refer to Digital Sensors , page 104. Connect the RDT-5 Backup Active Port to the controller’s digital input card. Refer to the installation manual.

CAUTION Verify that the input port defined in Installation > Digital Sensors matches the port on the digital input card used to connect the units!

5.10.2 SAVING AND LOADING RDT-5 TABLES

In Version 6.19, the Platinum Pro/Rotem Pro controllers store (backup) the RDT-5 temperature curve tables. This function enables transferring the tables from a configured RDT-5 to another, unconfigured RDT-5.

To transfer settings:

1. Wire an RDT-5 unit to the controller, perform a [Cold Start](#) (page 17), and define the temperature curve on the RDT-5 or on the controller (see the above sections).
2. Save the controllers settings to an SD card. Refer to Saving to an SD Card, page 95 for details.
3. Connect the second RDT-5 unit to the controller and perform a [Cold Start](#)
4. Upload settings from the SD card. Refer to Loading from an SD Card, page 96 for details. Verify that you are uploading the correct file!

NOTE If there is any interruption while uploading settings, the tables may not transfer. In this case, a message will appear informing you of the issue.

5.10.3 RDT-5 / TEMPERATURE CURVE | SET DEFINITIONS

- ① While viewing the RDT-5 / Temperature Curve menu: Press **HELP**, select **SET**, and press **ENTER**.

RDT-5 STAGE SETTINGS	
Stage 1 Diff	-2.0
Stage 2 Diff	-5.0
Stage 3 Diff	2.0
Stage 4 Diff	4.0
Stage 5 Diff	6.0
Stage 1 Type	HEAT
Stage 2 Type	HEAT
Stage 3 Type	COOL
Stage 4 Type	COOL
Stage 5 Type	COOL

- Define the parameters as required:
 - **Stage 1 – 5 Diff:** Enter the difference from the target temperature that activates a heater or cooler for each stage. These numbers appear on the RDT-5 / Temperature Curve screen.
 - **Stage 1 – 5 Type:** Select Heat or Cool. Each RDT-5 relay serves as a heater or cooler relay. This parameter enables displaying the relay definition on the screen.

CAUTION *Selecting Heat or Cool in this screen does not define the relay; it only displays the relay type. Actual relay definition is done in the RDT-5 unit, by placing a jumper on certain pins. Meaning: if a relay is defined in this screen as a heater, but the jumper placement defines the relay as a cooler, the relay is a cooler. Refer to the RDT-5 manual for details.*

5.10.4 RDT-5, VERSION 6.22

In Platinum Pro Version 6.22.01, the growth day and days in the temperature curve can be set to -7 & up. RDT-5 Version 1.5.8 also supports this feature. However, if, when used together one of the products is operating using legacy software, there can be operational errors. The following table explains possible errors if the growth day and RDT-5 temperature curve days are defined as negative days when using legacy software for either product.

	Platinum V6.22	RDT-5 Ver 1.5.8
Platinum Pro V6.21		<ul style="list-style-type: none"> • Negative days in the RDT-5 appear incorrectly. • RDT-5 functions may not operate properly.
RDT-5 Ver < 1.5.8	Negative days are not transmitted to the RDT-5. Both units operate as if they are operating using legacy software.	

CAUTION *Munters recommends that users who employ RDT-5 units update that product's software when you update the Platinum Pro software to version 6.22.*

6 Scale Menu

- Scale Layout, page 70
- Bird Scale Setting, page 71
- Silo Setting, page 72
- Bird Weight, page 73
- Gender Based Weighing, page 74
- History, page 76
- Calibration, page 77
- Silo / Auger Layout, page 78

SCALE
1. SCALE LAYOUT
2. GENERAL SETTINGS
3. BIRD SCALE SETTING
4. SILO SETTING
5. BIRD CURVE
6. HISTORY
7. FEED CONVERSION
8. TEST
9. CALIBRATION
10. SILO/AUGER LAYOUT

In Versions 6.22 or above, setting up a bird curve means defining the following items in the Scale Menu:

- [Scale Card](#): Define at least one scale.
- Gender Separated Weighing: Define if weight curves are gender separated.
 - [Non-gender separated](#) weighing provides an automatic curve, a user-customized curve, or industrial standard curves.
 - [Gender separated weighing](#) provides automatic curve, an automatic turkey curve, or a user-customized curve.
- [Bird Scale Setting](#): Define the curve type (Auto, Custom, or Factory Curve)
- [Bird Weight](#): Define the reference weight or curve data points (day and weight).

NOTE Users employing a previous software version, refer to Appendix E: Previous Version Functions, page 145.

6.1 Scale Layout

Use Scale Layout to define the scales or silos connected to the controller.

- Scale Layout Main Screen
- Scale Layout | Set Definitions

6.1.1 SCALE LAYOUT MAIN SCREEN

NOTE A scale card must be installed in the controller or an RSU-2 unit must be connected to the controller for these screens to appear.

Platinum Pro/Rotem One supports the RSU-2 and two types of scale cards:

- Two channel scale cards: Supports bird scales only.
- Six channel scale cards: Supports bird, silo, and feed scales (Breeder Mode does not support feed scales). The controller can support up to ten weighing channels.

- Refer to the installation manual regarding Munters' recommendations regarding these options.

SCALE LAYOUT		
Scale Card		
Chan.	Function	No.
1	Silo 1	1
2	Silo 2	2
RSU 1		
1	Silo 3	3
2	Silo 4	4

Figure 8: Two Channel Layout

SCALE LAYOUT		
Ch.	Function	No.
Scale Card		
1	Scale	1
2	Scale	2
3	Silo	1
4	Silo	2
5	Feed Scales	1
6	Scale	3
RSU 1		
1	Silo 3	3
2	Scale 3	3

Figure 9: Six Channel Layout

6.1.2 SCALE LAYOUT | SET DEFINITIONS

- ① While viewing the Scale Layout menu: Press HELP, select SET, and press ENTER.

SYSTEM PARAMETERS	
SCALE LAYOUT SETTINGS	No
Separate Male Female	Yes

- If male and female birds live in the same house, select No.
- If you want separate male/female weight curves, refer to Gender Based Weighing, page 74.

6.2 Bird Scale Setting

NOTE This screen relates to Version 6.19 and above.

- ➡ Define at least one scale, silo, or feed scale in Scale Layout.

This section describes the Bird Scale Settings for Broiler mode. Refer to Breeder and Layer Mode appendices to view the function for those modes.

- Bird Scale Setting Screen
- Bird Scale Setting | Set Definitions

6.2.1 BIRD SCALE SETTING SCREEN

In this screen, select the algorithm used to calculate the bird curve that appears in Bird Weight. There are three options:

BIRD SCALE SETTING	
Weighing Method	Auto

Auto
Custom
Cobb 500
Cobb 700
Ross 308

- **Auto:** Set the first target weight. The controller then automatically calculates each day's reference weight.
- **Custom:** The controller provides a weight vs growth day curve, which the user can edit as required.
- **Factory Default Curve:** The controller loads an industry standard bird curve. This curve cannot be edited.

6.2.2 BIRD SCALE SETTING | SET DEFINITIONS

- ① While viewing the Bird Scale Setting menu: Press **HELP**, select **SET**, and press **ENTER**.

BIRD SCALE SETTING	
Range Method	Auto Manual

This parameter defines the range of weights that are recorded. Bird weights that are outside of the band are discarded.

- If you select Auto, Platinum automatically calculates the band of acceptable weights.
- If you select Manual, define the upper and lower ranges.

BIRD SCALE SETTING	
Range Method	Manual
Upper Range [%]	25
Lower Range [%]	25

6.3 Silo Setting

These settings help you monitor your silo through weighing. There are two events that take place, emptying (feeding) and filling (loading).

NOTE Silos must be defined in Scale Layout for the following parameters to be functional.

SILO SETTING	
Minimum Filling Weight	2000
Filling Detection Weight	300
Resume Time (minute)	5

- **Minimum Filling Weight (Default: 2000 Kg):** Define weight required to be filled during loading to be recorded in History – Feed, page 80 History –Table of Events, page 81; Scale – **Feed Conversion**.
- **Filling Detection Weight (Default: 300 Kg):** Define the weight you want your controller to detect a filling to stop augers.
- **Resume Time (minute) (Default: 5 min.):** Once loading is completed, define the time you want your controller to count down for the augers to resume normal operation.

The following is a typical scenario:

A loading truck will come to fill the bin or silo. Define the **Filling Detection Weight** to stop the augers from operating during a loading event (Default: 300 Kg). Next, a **Minimum Filling Weight** needs to be defined in order to have the filling event recorded in the Feed Inventory (Default: 2000 Kg). Once the loading of the feed is finished, the timer begins to count down for the augers to resume normal operation (**Resume Time**, Default: 5 minutes) and for the filling event to be recorded as completed.

6.4 Bird Weight

- Bird Weight Main Screen
- Bird Weight Help | Set Definitions

6.4.1 BIRD WEIGHT MAIN SCREEN

In this screen, edit the bird curve selected in Bird Scale Settings.

- Go to Scale > Bird Weight .
 - If you selected Auto in Bird Scale, edit the weight as required. The weight is automatically adjusted.

BIRD WEIGHT	
Current Weight	0.09

- If you selected Custom in Bird Scale, edit the curve as required.

BIRD WEIGHT	
Day	Weight
0	0.00
7	0.00
14	0.00
21	0.00
28	0.00

- If you selected an industrial standard, the curve is read only.

BIRD WEIGHT	
Day	Weight
0	0.10
7	0.31
14	0.66
21	1.06
28	1.46

6.4.2 BIRD WEIGHT HELP | SET DEFINITIONS

NOTE This option is only available if you chose Custom or an industrial standard curve.

- ② While viewing the *Bird Curve* menu: Press **HELP**, select **SET** and press **ENTER**.
 - Enter the factor used to adjust the weight curve. This amount is added to the Reference weight field. Range: 0.0 – 10.0 Kg/Lb.

BIRD WEIGHT	
Curve Offset	0.2

6.5 Gender Based Weighing

Version 6.22 provides an option for gender-based weighing.

1. Go to Scale Layout > Help.

SYSTEM PARAMETERS	
SCALE LAYOUT SETTINGS	
Separate Male Female	Yes

2. Select Yes.

3. Go to Scale Settings > Bird Scale > Help. Select Auto or Manual.

BIRD SCALE SETTING	
Range Method	Auto Manual

This parameter defines which measured bird weights are used in calculating the actual curve. Bird weights that are outside of the band are discarded.

- If you select Auto, Platinum calculates the band of acceptable weights.
- If you select Manual, define the female/male upper and lower weight ranges.

BIRD SCALE SETTING	
Range Method	Manual
Female	
Upper Range [%]	10
Lower Range [%]	15
Male	
Upper Range [%]	15

4. Go to Scale Settings > Bird Scale.

BIRD SCALE SETTING	
Weighing Method	Auto Curve Auto Turkey
Scale 1	Female
Scale 2	Female
Scale 3	Female
Scale 4	Female

- Define the weighing method: Auto, Curve, Auto Turkey. Curve includes a user-defined curve option and industrial standard curve options.
- Define each scale as female or male.
- Auto or Auto Turkey Curve
- Customized/Industrial Standard Curves

6.5.1 AUTO OR AUTO TURKEY CURVE

- Go to Scale > Bird Weight .
 - If you selected Auto or Auto Turkey in Bird Scale, edit the weights as required. The weight is automatically adjusted.

BIRD WEIGHT	
Current Female Weight	0.09
Current Male Weight	0.09

- If you selected Curve in Bird Scale, edit the curve as required.

BIRD WEIGHT		
Day	Female	Male
0	0.00	0.00
7	0.00	0.00
14	0.00	0.00
21	0.00	0.00
28	0.00	0.00

6.5.2 CUSTOMIZED/INDUSTRIAL STANDARD CURVES

1. Go to Scale > Bird Weight > Help.

SYSTEM PARAMETERS	
Female	
Curve Offset	0.00
Select Curve	Custom
Male	
Curve Offset	0.00
Select Curve	CobbMV

2. For female and male, enter the factor used to adjust the weight curve. This amount is added to the Reference weight field. Range: 0.0 – 10.0 Kg/Lb.
3. For female and male, select the required curve from the drop-down list.
4. Go to Scale > Bird Weight.

BIRD WEIGHT		
Day	Female	Male
0	0.09	0.09
7	0.35	0.33
14	0.62	0.75
21	0.88	1.16
28	1.15	1.53

- If you selected Custom, you can edit the curve.
- If you selected an industrial standard curve, the curve is read only.

6.6 History

The scale history shows bird weight statistics. You can review daily data for each scale, or separately.

HISTORY									
Day	Avg.	D.Gain	Unif.	No.	Scale1	D.Gain	Unif.	No.	
1	0.00	0.00	0.00	0.00	0.00		0.00	0.00	
2	0.00	0.00	0.00	0.00	0.00		0.00	0.00	
3	0.00	0.00	0.00	0.00	0.00		0.00	0.00	

- The D. Gain shows difference between the current average weight and the previous day's average weight; the data comes from all the scales.
- No daily gain is shown for individual scales.

6.7 Feed Conversion

This screen displays the amount of feed converted into the bird's weight.

NOTE Only Broiler/Layers Mode supports this function.

FEED CONVERSION			
Day	Bird Weight	Daily Feed	Feed Conversion
17	0.00	0	N/A
18	0.00	0	N/A
19	0.00	0	N/A
20	0.00	0	N/A
21	0.00	0	N/A
22	0.00	0	N/A
23	0.00	0	N/A
24	0.16	0	0.00
25	0.00	0	N/A
26	0.00	0	N/A

6.8 Test

This section is a real-time table to show the statuses of all scales connected to the controller. Make sure that all statuses are O.K. If any of them show a different status, the scale is not installed properly. Unused positions can also show O.K.

1. In *Scale > Scale Layout* (refer to page 70), select the required scale types.
2. In *Scale > Test*, test the scales as required.

TEST			
Ch	A/D	Weight	Status
Silo 1	2024	0.222	O.K.
Silo 2	2010	0.240	O.K.
Feed Scale 1	2024	0.200	O.K.
Silo 3	2011	0.240	O.K.
Scale 1	2000	0.222	O.K.
Scale 2	2024	0.222	O.K.

6.9 Calibration

This menu calibrates the scales connected to the controller.

CAUTION Do not use scales while calibrating.

6.9.1 SCALE CALIBRATION

1. Follow instructions on the bottom section of the screen.
2. Wait until the progress bar displayed shows 100%.
3. Place a known weight on the scale and enter its weight.
4. Wait until the calibration progress bar reaches 100%.
5. Ensure “Good Calibration.”

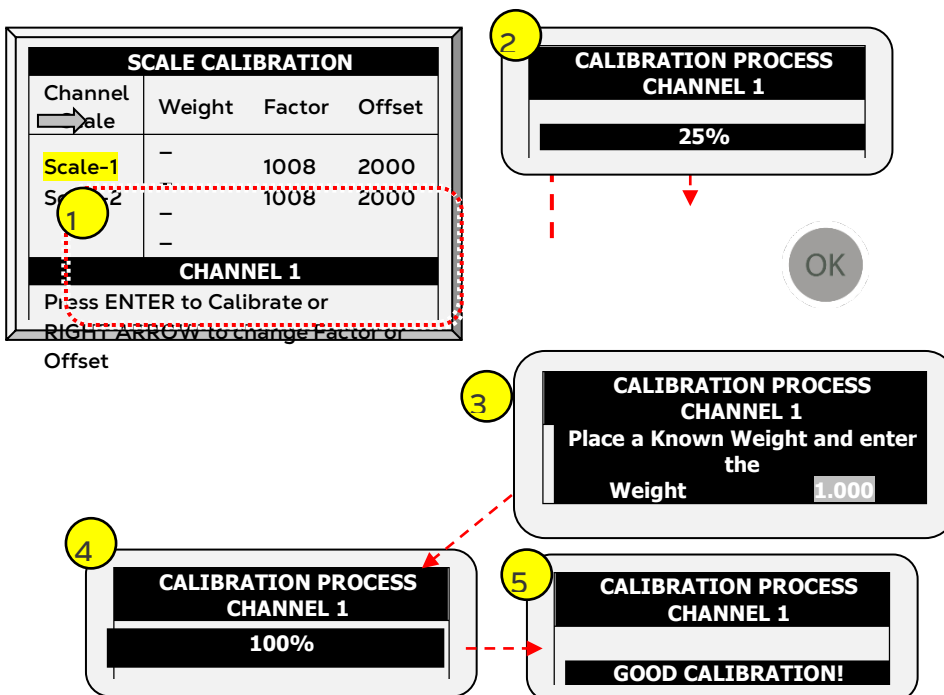

6.9.2 SILO CALIBRATION

1. Follow instructions on the bottom section of the screens.
2. Wait until the progress bar displayed shows 100%.
3. Place a known weight or start filling the feed bin.
4. Wait until the calibration progress bar reaches 100%.
5. Ensure “Good Calibration.”

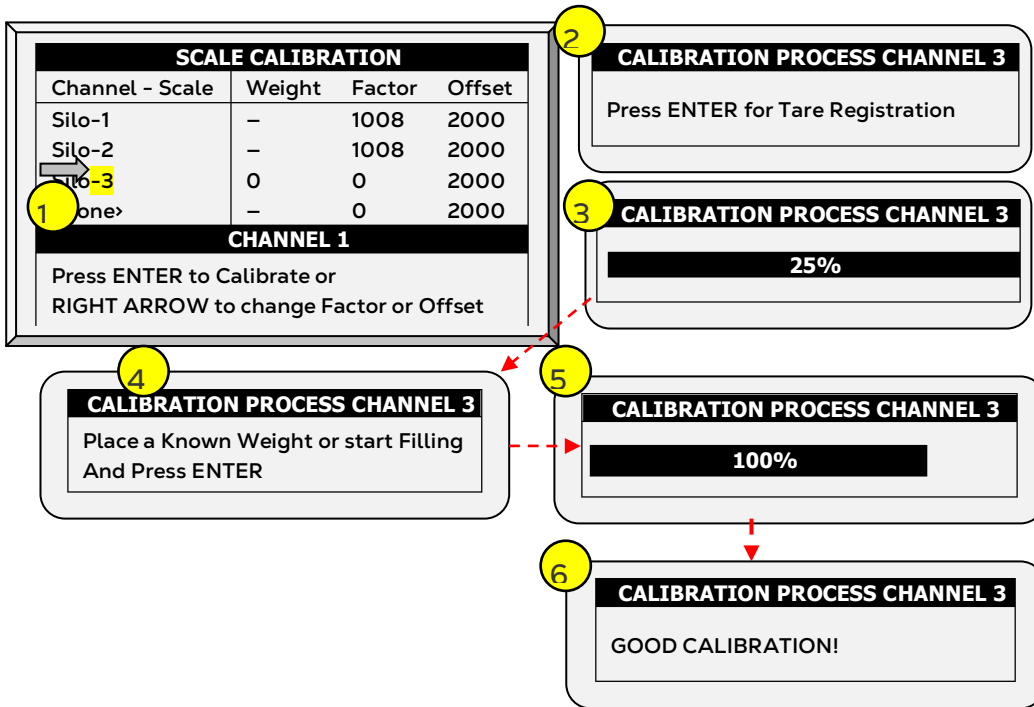

6.10 Silo / Auger Layout

This menu maps augers to a specific silo. Map up to four augers to four silos (one each).

NOTE Only Broilers mode supports this function.

SILO/AUGER LAYOUT	
Silo	Auger
1	Auger-1
2	Auger-2
3	None
4	None

7 History Menu

- Temperature
- Humidity
- CO2
- Water
- Feed
- Mortality
- Heaters
- Radiant Heaters
- Alarms
- Table of Events
- Power Consumption
- Ammonia History
- Dosing History

HISTORY
1. TEMPERATURE
2. HUMIDITY
3. CO2
4. WATER
5. FEED
6. MORTALITY
7. HEATERS
8. RADIANT HEATERS
9. ALARMS
10. TABLE OF EVENTS
11. POWER CONSUMPTION
12. AMMONIA

7.1 Temperature

The temperature history menu stores minimum, average and maximum temperatures by growth day. The average is weighted, so if most of the day has been warm the average is closer to the maximum than the minimum.

7.2 Humidity

The humidity history menu stores minimum, average and maximum inside humidity by growth day. The average is weighted, so if most of the day has been humid the average is closer to the maximum than the minimum.

NOTE This feature requires installing a humidity sensor.

7.3 CO2

The CO2 history menu stores minimum, average and maximum inside CO2 levels by growth day. The average is weighed, so if most of the day has seen high CO2 levels the average is closer to the maximum than the minimum. If two sensors are installed (Version 6.20) data points show the average of both sensors.

7.4 Water

The water menu records daily water consumption and shows the daily differential change from the previous day in percent. You must have the water monitor digital inputs

connected. You can monitor up to two drinking water meters, total drinking water, total water, cool pad, fogger, and cold pad flush consumption.

7.5 Feed

The feed menu records daily feed consumption and shows the daily differential change from the previous day in percent for two silo systems. You must have a silo weighing system installed for the feed system or monitor the auger system.

The feed data can be based on one of the following inputs. If more than one input is installed, priority is according to the order of the bulleted list.

- **Feed Bin:** If feed bins (load cells) are installed, feed consumption data of each bin is based on the feed bin weight.
- **Current Sense:** If Current Sense Relays for Augers are installed and calibrated (refer to Calibration, page 98), feed consumption data of each auger is based on the current sense, calculation method settings, and actual auger run-time. The run-time is calculated based on the measured current, when the actual current is higher than the nominal value (refer to Relay Current, page 66).
- **Feed Count:** If a feed count sensor is installed feed consumption for each feed count input is based on the feed count method settings (refer to Digital Sensors, page 104).

7.6 Mortality

The mortality history menu maintains daily summaries of mortality cull and total dead. It also shows the percentage dead and gives an updated count of bird inventory. The history is maintained separately for male, female and total. Use the left and right arrow keys to switch to the next screen.

7.7 Heaters

The Platinum Pro/Rotem Pro maintains daily total run times of each heater. The table fills several screens; to view the off-screen data, use the arrow keys to scroll. The data is in hours:minutes format.

7.8 Radiant Heaters

The Platinum Pro/Rotem Pro maintains daily total run times of each radiant heater, including separate data for low level and high-level heaters. The table fills several screens; to view the off-screen data, use the arrow keys to scroll. The data is in hours:minutes format.

7.9 Alarms

The alarm history records the growth day and time of each alarm. Alarms that are currently activate show as flashing in the screen. The alarm history does not erase with the New Flock function under Management, Growth Date & Flock. The last 250 alarms are saved, and as the table fills, new alarms push out the oldest alarms.

7.10 Table of Events

The Platinum Pro/Rotem Pro records significant events with growth day and time stamp. The Table of Events is 1000 events long and does not erase with the New Flock function under Management, Growth Date & Flock. New events push out the oldest events.

Typical events recorded are switch changes, entry into tunnel, natural or minimum ventilation, alarm resets, ventilation mode changes, etc. The Table of Events is an excellent tool to determine whether your controller is going in and out of tunnel due to marginal settings as well as finding and identifying problems

NOTE Go to Table 6, page 113 to view all the available events.

7.11 Power Consumption

This menu displays the daily power consumption (in Kwh) of the heaters, fans, lights and other equipment and the change from the previous day.

NOTE Current sense relays are required for this function to be enabled.

NOTE The Relay Current feature supports single phase electricity only.

7.12 Ammonia History

This screen displays the minimum, average, and maximum ammonia levels, by growth day.

7.13 Dosing History

This screen displays the date, total work time, water volume transmitted, and total volume of dosage material added. Because the type of additive can be change, the controller records each additive's history separately.

Version 6.22: Scroll right and left to view the history of each particular pump.

8 Test Menu

The test menu screen shows internal information in order to verify that the Platinum Pro/Rotem Pro is operating correctly. Moreover, it can help find broken wires or any other problems related to it.

- Switches & Relays, page 82
- Switches & Relays Extension, page 83
- Alarm, page 83
- Analog Sensors, page 83
- Digital Sensors, page 84
- Analog Output, page 84
- Static Pressure, page 84
- Communication, page 85
- Hardware Checklist, page 85

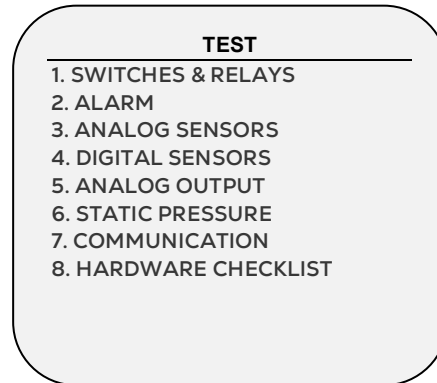

8.1 Switches & Relays

This menu displays a screen of identified switches and relays installed in the controller. Use this option to determine faulty hardware.

The Platinum Pro/Rotem Pro supports a maximum of 50 relays; using an Extension unit enables an additional 50 relays. The following screen illustrates a system having 80 switches and relays.

SWITCHES & RELAYS									
01	02	03	04	05	06	07	08	09	10
Aut	Aut	Aut	Aut	Aut	Aut	Aut	Aut	Aut	Aut
11	12	13	14	15	16	17	18	19	20
Off	Off	Aut	Aut	Aut	Aut	Aut	Aut	Aut	Aut
21	22	23	24	25	26	27	28	29	30
Aut	Aut	Aut	Aut	Aut	Aut	Aut	Aut	Aut	Aut
31	32	33	34	35	36	37	38	39	40
On	Aut	On	Aut	Aut	Aut	Aut	Aut	Aut	Aut
41	42	43	44	45	46	47	48	49	50
Aut	Aut	Aut	Aut	Aut	Aut	Aut	Aut	Aut	Aut
51	52	53	54	55	56	57	58	59	60
Off	Off	Aut	Aut	Aut	Aut	Aut	--	--	--
61	62	63	64	65	66	67	68	69	70
--	--	--	--	--	--	--	--	--	-

8.2 Alarm

Press Enter to toggle the Alarm Relay. ON indicates Alarm, OFF indicates No Alarm. Note that the alarm relay is powered for the 'NO ALARM' condition to provide automatic Power Fail Alarm in case of power failure to the Platinum Pro/Rotem Pro. That is, the Normally Open side is closed during NO ALARM.

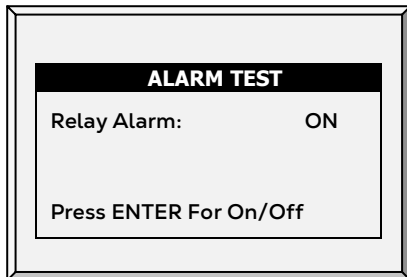

8.3 Analog Sensors

The screenshot shows a menu titled "ANALOG SENSORS" containing a table with the following data:

In.	Sensor	A/D	Value
1	Temp. Sensor 1	457	82.4
2	Temp. Sensor 2	1023	----
3	Temp. Sensor 3	461	81.5
4	Temp. Sensor 4	1023	----
5	Temp. Sensor 5	0	----
6	Temp. Sensor 6	0	----
7	Potentiometer 1	1023	----
8	<none>	0	----
9	<none>	0	----
10	<none>	0	----
11	<none>	0	----

Observe the converter readings for analog sensors with this menu. The readings can vary from 0 to 1023. The values displayed in the 'Value' column indicate that the analog sensor is either operating or not connected according to the following:

- If a very large value is shown (such a four-digit number) or a small value is shown (such as a one-digit number): sensor is **not connected**.
- If the unit displays a 3-digit number, usually beginning with the digit '4': sensor is **operating**.

8.4 Digital Sensors

DIGITAL IN TEST			
In.	Sensor	State	Counter
CARD 1			
1	Water Meter 1	1	0
2	Water Meter 2	0	0
3	Fogger Water Meter	0	0
4	AUX. Alarm	0	0
5	AUX. Alarm	0	0
6	Low Water Pressure	0	0
7	Wind Speed	0	0
8	<None>	0	0
Box 1	Card 1	Slot 3	Channel 1

Observe the state of the 8 digital sensors. A '1' indication implies a shorted input, a '0' an open input. The digital sensors operate with dry contact inputs such as the Arad Water Meter, or micro-switches.

Applying a short/open input to each channel can be done and observing the response on the display is available.

8.5 Analog Output

This screen tests light dimmers, variable speed fans, and variable heaters.

1. Scroll to the required output.
2. Enter the test voltage and verify that the device is operating.

ANALOG OUT TEST		
Output.	Sensor	0 – 10v
CARD 1		
1	Light Dimmer 1	0.0
2	Light Dimmer 2	0.0
3	Light Dimmer 3	0.0
4	Var. Heat	0.0
5	W.O.D	0.0
6	<None>	0.0
7	<None>	0.0
8	<None>	0.0
Box 1	Card 1	Slot 3 Channel 1

8.6 Static Pressure

Observe the converter readings for the static pressure sensor. The nominal 'zero' pressure reading is 130. Remove the air hoses from the brass connectors on the left side outside of the controller to check this reading.

STATIC PRESSURE	
A/D Counts	126

8.7 Communication

This menu facilitates testing on communication networks. A multiplexer in loop back mode is used to test the communication. The Platinum Pro/Rotem Pro follows its' own communication to check for failed hardware. Follow the instructions displayed on the screen.

To perform this test you must short RX with TX on the non-priority channel of the multiplexer

PRESS ENTER TO CONFIRM

8.8 Hardware Checklist

Check the installed hardware that has been identified by the Plug and Play system. The system detects all cards except Communication. The standard optional Communication card provides lightning protection and does not have local computerized intelligence to identify itself to the system. Note that if a card is missing, turn the power OFF and then ON for a card rescan.

HARDWARE CHECKLIST				
Card	Box	Slot	Status	Chann.
Analog In				12
Analog In 1	1	2	OK	12
Digital In 1				12
	1	1	OK	12
Analog Out 1	1	3	OK	10
Scales				0
Static Press				0
Alarm				1
Alarm 1				1
Relays				50
N.O. 1	1	1	OK	10
N.O. 2	1	2	OK	10

9 Service Menu

The Service Menu items calibrate various Platinum Pro/Rotem Pro functions.

- Temperature Calibration, page 86
- Humidity Calibration, page 87
- CO2 Sensor, page 87
- Static Pressure Calibration, page 88
- Light Sensor Calibration, page 89
- Feed Calibration, page 90
- Water Calibration, page 90
- Potentiometer Calibration, page 90
- Nipple Flushing, page 91
- Feeders & Drinkers, page 93
- Save Settings, page 94
- Load Settings, page 96
- Current Sense Relay Calibration, page 98
- Wind Direction Calibration, page 99
- WOD Calibration, page 99
- Ammonia Calibration, page 100

SERVICE	
1. TEMP. CALIBRATION	
2. HUMIDITY CALIBRATION	
3. CO2 CALIBRATION	
4. STATIC PRESSURE CAL.	
5. LIGHT SENSOR CALIBRATION	
6. FEED CALIBRATION	
7. WATER CALIBRATION	
8. POTENTIOMETER CALIBRATION	
9. NIPPLE FLUSHING	
10. FEEDERS & DRINKERS	
11. SAVE SETTINGS	
12. LOAD SETTINGS	
13. CURRENT SENSE RELAY CALIB.	
14. WIND DIRECTION CALIB.	
15. W.O.D CALIBRATION	
16. AMMONIA CALIBRATION	

9.1 Temperature Calibration

The Platinum Pro/Rotem Pro temperature sensors are typically accurate to approximately 0.5° F within the range of temperatures for poultry production. Calibrate them in this menu by adding/subtracting a constant correction factor to each sensor. Adjust the sensor of your choice with the left/right arrow keys.

TEMPERATURE CALIBRATION		
Sensor	Temp°	Factor
1	78.2	1.6
2	86.4	0.9
3	83.0	-1.5
4	86.2	0.8
5	85.2	-1.6
6	84.2	0.0

Calibrating against infrared or in air temperature sensors generally results in less accuracy than the basic sensors have without calibration.

To calibrate the unit:

1. Obtain an accurate reference sensor and a pail of water at the approximate temperature desired.
2. Stir the reference sensor together with the Platinum Pro/Rotem Pro sensor vigorously in the bucket of water. Keep hands off the sensor itself, so that it responds accurately to the water temperature. Stirring is necessary to preclude stratification within the bucket of water.
3. Call out the accurate reading to a second person standing at the Platinum Pro/Rotem Pro. Walkie-talkie radios may be a good idea.
4. The individual at the controller should double-check that you are calibrating the correct sensor. You might warm/cool the sensor temporarily to see which sensor changes temperature appropriately.
5. Once you determine the correct temperature and allow approximately one minute for stabilization in the water, adjust the sensor reading at the controller.
6. Offset the factor using the left/right arrow keys.

9.2 Humidity Calibration

To calibrate the humidity level, obtain a suitable humidity test kit, and use the procedures described there. They are commonly available via the Internet.

HUMIDITY CALIBRATION		
Sensor	Humidity°	Factor
In	58.9	2.3
Out	N/A	---

Press Left/Right Arrows to Calibrate

- Adjust the Platinum Pro/Rotem Pro reading as needed using the left/right arrow keys.

9.3 CO2 Sensor

To calibrate the CO2 level, obtain a suitable test kit and use the procedures described in the kit. Ensure that the house is well ventilated.

CO2 SENSOR CALIBRATION	
	Value
PPM at 4 mA/1 VDC	26
PPM at 20 mA/5 VDC	3000
Factor (PPM)	22

CO2 (ppm): 482

Figure 10: CO2 Calibration, Version 6.19 and below

CO2 SENSOR CALIBRATION	
CO2 - 1	
PPM at 4 mA/1 VDC	26
PPM at 20 mA/5 VDC	3000
Factor (PPM)	22
CO2 - 2	
PPM at 4 mA/1 VDC	26
PPM at 20 mA/5 VDC	3000
Factor (PPM)	22

CO2 -1 (ppm): 1243
CO2 -2 (ppm): 1218

Figure 11: CO2 Calibration, Version 6.20 (if two sensors are defined in Analog Sensors, page 103)

- Ppm at 4 mA / 1 VDC: Parts per million for 4 mA or 1 VDC
- Ppm at 20 mA / 5 VDC: Parts per million for 20 mA or 5 VDC
- Factor (ppm): (-/+) ppm shift from the current reading
- CO2 (ppm): Current CO2 readings

1. In *Installation* > *Analog Sensor*, define an analog sensor as a CO2 sensor.
2. In *Service* > *CO2 Calibration*, adjust the Platinum Pro/Rotem Pro reading as needed using the left/right arrow keys.
3. In *Manage* > *Alarm Setting*, Set the [CO2 Sensor Alarm](#).

9.4 Static Pressure Calibration

The Static Pressure should be 0 when there is no ventilation and the house is closed. When the controller reads 130 A/D counts, this is 0 static pressure. Check for blocked air hoses or wind interference for inaccurate readings.

NOTE Allow Platinum Pro/Rotem Pro to run for a few hours so that the temperature in the box becomes stable and only then may you calibrate.

There are two ways of calibrating the sensor to 0:

- Software calibration: 130 ± 40
- Hardware calibration: Adjust trimmer

STATIC PRESSURE CALIBRATION	
A/D Counts:	126
Disconnect air hoses from the Platinum to zero the pressure	
Then Press ENTER to calibrate	

STATIC PRESSURE CALIBRATION	
A/D Counts:	126
GOOD CALIBRATION	
Press MENU to exit	

NOTE A/D Counts of 130 ± 40 is considered a good calibration.

Calibrate the static pressure physically using the calibration screw on the sensor card prior to completing the software calibration.

- **Hardware Calibration:** With air hoses removed, adjust the zero-pressure reading to approximately 130 by turning the calibration screw with a small jeweler's screwdriver.
- **Software Calibration:** After hardware calibration, follow the procedure given by the controller.

The calibration procedure adjusts the zero-pressure reading. The static pressure sensor is located inside the controller in the upper left-hand corner to the left of the power supply.

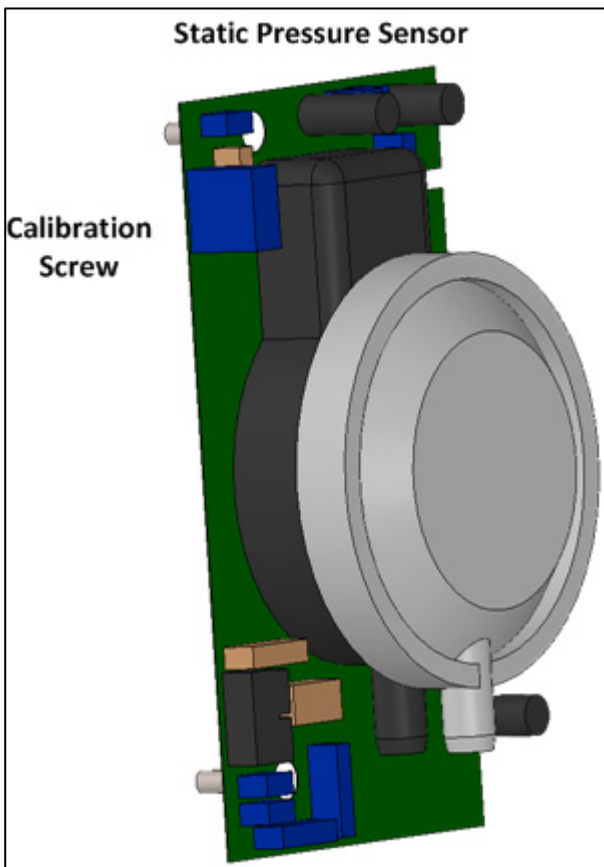

9.5 Light Sensor Calibration

Installing a light sensor enables turning off the lights when there is sufficient outside light.

To calibrate the light sensor:

1. Go to *Install* > *Analog Sensors* (page 103).
2. Define one sensor as a light sensor.
3. Go to *Device* > *Light* (page 42).
4. Press Help, highlight Set, and press Enter.
5. Scroll down to Light Sensor Active and set to Yes.
6. Place the sensor in the required location.
7. Go to *Service* > *Light Sensor Calibration*.

8. When the outside light is bright enough, press **Enter**

9.6 Feed Calibration

The Platinum Pro/Rotem Pro can use feed bin scales or less expensive digital monitoring devices to keep track of your feed. This menu calibrates the digital monitoring devices.

To calibrate the digital monitoring device:

1. Select the feed counting method. Your digital monitoring device may generate a dry contact pulse for each quantity of feed, or it may simply indicate that the feed is running.
2. Enter the quantity of feed per pulse in case you use a dry contact pulse. Otherwise, enter the amount of feed delivered per minute of auger operation.
3. Select one of the following:
 - Pulse: Weight per pulse
 - Time: Weight per minute
 - Current Sense: Motor run time when the auger contains feed
4. Enter quantity - weight per minute.

FEED CALIBRATION				
Feed	1	2	3	4
Method	TIME	TIME	TIME	TIME
Factor	2.203	2.203	2.203	2.203

Method Pulse: Weight per Pulse
 Method Time: Weight per Minute
 Method Current Sense: Weight per Minute

9.7 Water Calibration

The Platinum Pro/Rotem Pro supports up to four dry contact pulse output water meters. Enter the quantity of water per pulse for your water meters.

WATER CALIBRATION			
Water 1	-	Water Per Pulse	Time
Water 2	-	Water Per Pulse	Time
Cool Pad	-	Water Per Pulse	2.203
Fogger	-	Water Per Pulse	2.203

9.8 Potentiometer Calibration

Use this screen to calibrate the ventilation potentiometer control. Potentiometer calibration is required before ventilation can be controlled via a potentiometer.

POTENTIOMETER CALIBRATION				
Pot	Device	Close	Current	Open
1	Vent 1	152	0	1000
2	Vent 2	152	187	1000

➤ **Before calibrating the potentiometers:**

- Disable the static pressure unit in *Install > Setup* (page 101).
- Define at least one relay as vent/inlet/tunnel in *Install > Relay Outlet* (page 102).
- Define at least one analog sensor as a potentiometer in *Install > Analog Sensor* (page 103).

1. Select a potentiometer number.

2. Press Enter.

The device relay closes and then opens. As this takes place, the numbers in the Close, Current, and Open columns change. After a few minutes, the process completes and a "Good Calibration" message appears.

NOTE After potentiometer calibration, the times displayed in the Vent/Curtain Setup screen change. Refer to /Curtain Setup, page 107 for details.

9.9 Nipple Flushing

To use this selection, program the water solenoids using the following relay codes:

- **111 Water Main:** The control's supplementary for the usual water line
- **112 Water By Pass:** The control's supplementary to bypass the water pressure regulator
- **113 Water line 1 through 122 Water line 10:** Individual water line supplementary to select the line to flush

During normal operation, only relay 111 water main is active. During flushing relay, code 112 is active together with each of the individual water line relays in turn.

- Configure up to five flush times.
- Set start time/duration of water flushing (water lines as defined by relay layout)

NIPPLE FLUSHING		
Start Time	On Time (min)	Status
06:00	2	AUTO
15:40	1	AUTO
00:00	0	AUTO
00:00	0	AUTO
00:00	0	AUTO

9.9.1 NIPPLE FLUSHING HELP | SET DEFINITIONS

② While viewing the Nipple Flushing menu: Press **HELP**, select **SET**, and press **ENTER**.

FLUSH ORDER							
Line:	1	2	3	4	--	-	-
Order:	1	2	3	4	--	-	-

FLUSHING DAYS							
Day:	Sun	Mon	TUE	WED	THU	FRI	SAT
Flush:	▪	√	√	▪	▪	▪	▪

- Flush Order: Set flushing according to line/order
- Flushing Days: Set flushing per day using '+/-' key

9.9.2 NIPPLE FLUSHING BY TEMPERATURE

Version 6.20 supports nipple flushing by temperature, in which the flushing only takes place when the water temperature in the pipes reaches a certain temperature. This function requires one water temperature sensor per house:

- Water Temperature Sensor PTC:
 - 1V (4 mA) = -40° C
 - 5V (20 mA) = 60° C
- Munters Water Temperature Sensor

NOTE Refer to the Installation Manual for details on installing these products.

To configure nipple flushing by temperature:

1. In Installation > Analog Sensor, define one sensor as Water Temp PTC and one sensor as Water Temp NTC.
2. In Installation > Relay Layout, define the required number of relays as Water Line.
3. Go to Service > Nipple Flushing. Note the flushing temperature appears on the main screen.

NIPPLE FLUSHING		
Start Time	On Time (min)	Status
06:00	2	AUTO
15:40	1	AUTO
00:00	0	AUTO
00:00	0	AUTO
00:00	0	AUTO

Water Temperature: 21.9

4. Go to Service > Nipple Flushing > Settings.

NIPPLE FLUSHING							
Water Temp to Flush	30.0						
Flushing Time Duration (min)	1						
Flushing Delay (min)	120						
Flush Before Sunrise	YES						
FLUSH ORDER							
Line:	1	2	3	4	--	--	--
Order:	1	2	3	4	--	--	--
FLUSHING DAYS							
Day:	Sun	Mon	TUE	WED	THU	FRI	SAT
Flush:	▪	√	√	▪	▪	▪	▪

5. Define:

- Water Temp to Flush: Water temperature at which flushing begins.
- Flushing Time Duration (min): Default 1 minute. Range: 0 - 250
- Flushing Delay (min): Default 120. Range: 1 - 999
- Flush Before Sunrise: Yes or No. Day is defined as when the light intensity reaches 70% of the intensity in the Light Table (refer to light, page 42).

NOTE These parameters appear even if water temperature sensors are not installed, but that situation they are irrelevant.

9.10 Feeders & Drinkers

- Feeders & Drinkers Main Screen
- Feeders & Drinkers Help | Set Definitions

9.10.1 FEEDERS & DRINKERS MAIN SCREEN

This selection enables inserting relevant information regarding feeder and drinker lines.

FEEDERS AND DRINKERS			
Day	Window Pos (%)	Feeder-Line Lift (inch)	Drinker-Line Lift (inch)
15	90	0.0	14.0
20	50	15.0	3.0
0	0	0.0	0.0
0	0	0.0	0.0
0	0	0.0	0.0
0	0	0.0	0.0
0	0	0.0	0.0

- Day: Insert day number.
- Window Pos (%): Insert the percentage of window's position.
- Feeder-Line Lift (Inch): Define the specific feed line lift, measured in inches.
- Drinker-Line Lift (Inch): Define the specific drinker line lift, measured in inches.

9.10.2 FEEDERS & DRINKERS HELP | SET DEFINITIONS

- ② While viewing the *Feeders & Drinkers* menu: Press **HELP**, select **SET**, and press **ENTER**

FEEDERS AND DRINKERS	
Adjust At Time	12:00
FEEDER WINDOW	
Stop Feed Before Adjust (Min.)	60
Time From Close To Open (sec)	15
FEED LINE	
Movement Time Per 10 inch (sec)	0
DRINKERS LINE	
Movement Time Per 10 inch (sec)	0

- Adjust at time: Set the desired time to adjustment.

FEEDER WINDOW

- Stop feed before adjust (min): Set how many minutes to stop before adjustment.
- Time from close to open (sec): Set how many seconds are needed from stop to open the feeder's window.

FEED LINE

- Movement time per 10 inch (sec): Set a number of seconds needed to move the feed line in 10 inches.

DRINKERS LINE

- Movement time per 10 inch (sec): Set a number of seconds needed to move the drinkers' line in 10 inches.

9.11 Save Settings

The method used to save the controller's settings to an external memory device is dependent on the hardware employed.

NOTE If both a data plug and SD card are inserted, the data plug takes priority and that option appears on the screen.

- Saving to a Data Plug
- Saving to an SD Card

9.11.1 SAVING TO A DATA PLUG

This menu enables the user to save his program settings to the supplied data plug and transport them to another controller for quick programming.

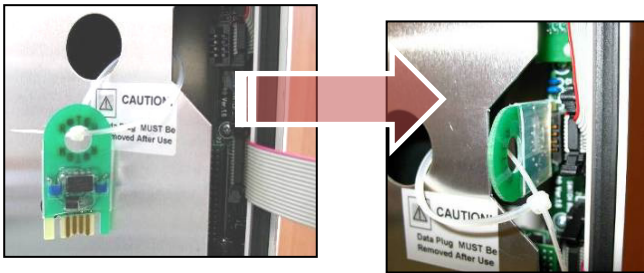

1. Insert data plug as shown.
2. Save controller settings.

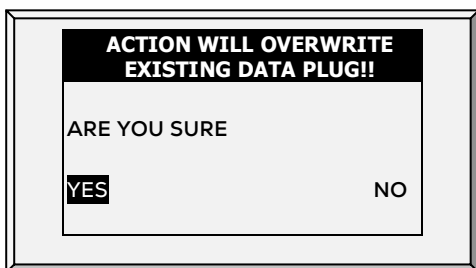

9.11.2 SAVING TO AN SD CARD

This menu enables the user to save the program settings to an SD card and transport them to another controller.

NOTE Verify that the SD card is in the “Unlocked” position (see the following illustration). The card must be in the Unlocked position to enable software upgrades.

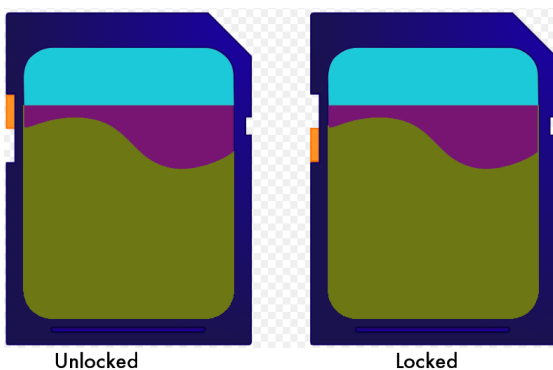

NOTE If both a data plug and SD card are inserted, the data plug takes priority and that option appears on the screen.

- ➡ Verify that the SD card is in place.
- ➡ The SD card must have at least 20K of free space.

To save settings:

1. Go to Service > Save Settings.
2. In the screen that appears, select YES and press Enter.
3. Select the required settings and press Enter.
4. Wait for the settings to download.

SAVE TO SD CARD		
1. Setting #1	8-Jan-13	12:00
2. Setting #1	15-Jan-13	12:00
3. Setting #1	23-Mar-13	12:00
4. Setting #1	15-Jun-13	12:00
5. Setting #1	15-Nov-13	12:00
6. Setting #1	01-Jan-14	12:00

9.12 Load Settings

This menu enables reading a saved program from a data plug into the controller quickly and reliably rather than configuring the settings manually.

9.12.1 LOADING FROM A DATA PLUG

- Verify that the program data is identical to the relay layout of the controller.
 - Follow the instructions given on the screen.

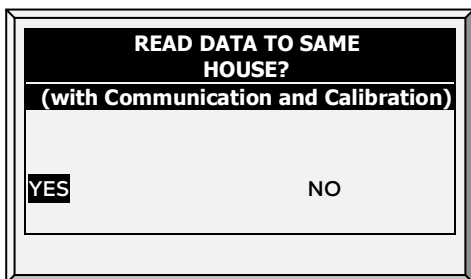
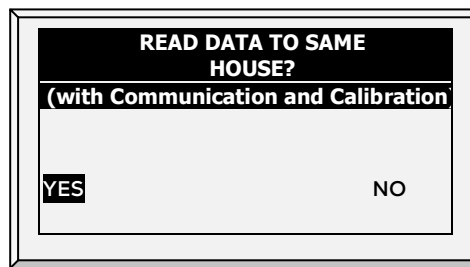
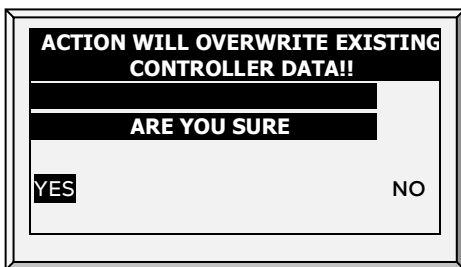

9.12.2 LOADING FROM AN SD CARD

This menu enables the user to load settings saved on an SD card into a controller.

NOTE If both a data plug and SD card are inserted, the data plug takes priority and that option appears on the screen.

- Verify that the SD card is in place.
- The SD card must have at least 20K of free space.

To load settings:

1. Go to Service > Load Settings.
2. In the screen that appears, select YES and press Enter.
3. Select the required settings and press Enter.
4. Wait for the settings to upload.

READ FROM SD CARD		
1. Setting #1	8-Jan-13	12:00
2. Setting #1	15-Jan-13	12:00
3. Setting #1	23-Mar-13	12:00
4. Setting #1	15-Jun-13	12:00
5. Setting #1	15-Nov-13	12:00
6. Setting #1	01-Jan-14	12:00

9.12.3 LOAD SETTINGS REPORT

NOTE Version 6.19 and above supports this function.

When uploading settings to a controller, Platinum Pro/Rotem Pro lists which tables (if any) will not be transferred. Compatibility issues might arise in cases when transferring settings between controllers using different software versions or having different configurations. By listing which tables will not transfer, the user knows which tables must be defined manually.

1. Go to Service > Load Settings.
2. In the screen that appears, select YES and press Enter.
3. Select the required settings and press Enter.
4. If there are any incompatible tables, a list of the pathways appears.

LOAD SETTINGS REPORT
The following tables can't be uploaded.
Install > Light Dimmers
Device > Light
Device > Light > Set
Scale > Scale Layout
Press MENU to Continue

5. Press Menu. The following message appears:

LOAD SETTINGS REPORT
Do you want to proceed with the procedure?
YES NO

6. To proceed, select YES.
 - After loading the settings and resetting the controller, a record of incompatible tables can be viewed in 62BTable of Events (page 81). Note that pathway is shown using a number to indicate the menu.

TABLE OF EVENTS			
	Event	Day	Time
20	Tunnel Ventilation	2	1:15:50
21	Minimum Ventilation	2	1:30:43
22	8. Light Dimmers	2	4:14:44
23	2. Light	2	4:14:44
24	2. Light / Set	2	4:14:44
25	4. Scale Layout	2	4:14:44
26	Data Read From Plug	2	4:14:44

9.13 Current Sense Relay Calibration

NOTE The Current Sense relays supports single phase electricity only.

This menu calibrates the amount of current that passes through Current Sense relays. Calibration enables configuring the minimum and maximum permissible currents.

To calibrate the current sense relay:

1. Define the relay (refer to Relay Layout, page 102).
2. Select *Service > Relay Current Cal.* The following screen appears.

RELAY CURRENT CALIBRATION			
Relay	Function	Measure	Current
			ON
31	Heat 6	Start	0.0
32	Heat 7	Start	0.0
33	Heat 8	Start	0.0
34	Exh. Fan 5	Start	0.0
35	Exh. Fan 6	Start	0.0

Warning!!!
 The selected equipment will be turned ON now for current reading adjustment WAIT till operation completion for 15 sec
 Verify that the relay switch is AUTO

3. Select a relay and click **Enter**.

NOTE The relay must be set to Auto.

4. Repeat for each current sense relay.

RELAY CURRENT CALIBRATION			
Relay	Function	Measure	Current
			ON
31	Heat 6	Done	0.2
32	Heat 7	Done	0.2
33	Heat 8	Done	0.2
34	Exh. Fan 5	Done	3.8
35	Exh. Fan 6	Done	4.3

Warning!!!
The selected equipment will be turned ON now for current reading adjustment WAIT till operation completion for 15 sec
Verify that the relay switch is AUTO

5. To set the minimum and maximum voltages, alarms and 110/220 voltage, refer to Relay Current, page 66.

9.14 Wind Direction Calibration

Use this screen to calibrate a wind direction sensor.

- Define an analog output sensor as wind direction.

WIND DIRECTION CALIBRATION		
	Direction	Calibration
Wind Direction	6	14.50

9.15 WOD Calibration

- WOD Calibration Main Screen
- WOD Calibration Help | Set Definitions

9.15.1 WOD CALIBRATION MAIN SCREEN

- Define an analog output sensor as WOD.

WATER ON DEMAND CALIBRATION		
	Volt	Pressure - PSI
WOD 1st Calib.	2.50	14.50
WOD 2nd Calib.	7.50	43.50

READ ME

Enter output voltage for first point.
Enter water meter measure pressure.
Repeat this for second point.

- In *Installation* > *Setup*, set the Length Unit.
 - Metric = Bar
 - Non-Metric = PSI
- In *Service* > *WOD Calibration*:

- a. Enter the first voltage and check pressure data points.
 - b. Repeat for second data points.
3. Set the Help Definitions (optional)

9.15.2 WOD CALIBRATION HELP | SET DEFINITIONS

This parameter reduces the water pressure a user-defined factor.

SYSTEM PARAMETERS	
WATER ON DEMAND	
Pressure Reducer Factor	50.00

1. In *Install* > *Setup*, define the Pressure unit.
2. In *Service* > *WOD Calibration* > *Help*, define the reduction factor. Water pressure is reduced by 1/50 (bar or PSI). The factor is accurate to two decimal points.

9.16 Ammonia Calibration

- Define an analog sensor as ammonia sensor.

To calibrate the ammonia level, obtain a suitable test kit and use the procedures described in the kit. Ensure that the house is well ventilated, either naturally or using fans.

- Only calibrate the sensor if you have reason to believe that they are producing inaccurate results.

AMMONIA CALIBRATION	
PPM at 0VDC	0
PPM at 5VDC	100
Factor (ppm)	0
AMMONIA (ppm) 15	

- Define the following:
 - Ppm at 0 VDC: Parts per million at 0 VDC
 - Ppm at 5 VDC: Parts per million at 5 VDC
 - Factor (ppm): (-/+) ppm shift from the current reading. Correct the sensor reading by editing this factor. Platinum Pro/Rotem Pro saves this data.
 - Ammonia (ppm): Current ammonia reading
 - Adjust the Platinum Pro/Rotem Pro reading as needed using the left/right arrow keys.
 - Refer to Ammonia Treatment.

10 Install Menu

The Install Menu items are used when installing input and output devices, as well as configuring critical parameters needed to run your controller properly.

- Setup, page 101
- Relay Layout, page 102
- Analog Sensors, page 103
- Digital Sensors, page 104
- Analog Output, page 106
- Curtain Setup, page 107
- Temperature Definition, page 109
- Fan Air Capacity, page 110
- House Dimensions, page 110
- Communication, page 111

INSTALLATION	
1. SETUP	
2. RELAY LAYOUT	
3. ANALOG SENSORS	
4. DIGITAL SENSORS	
5. ANALOG OUTPUT	
6. VENT/CURTAIN SETUP	
7. TEMP DEFINITION	
8. FAN AIR CAPACITY	
9. HOUSE DIMENSIONS	
10. COMMUNICATION	

10.1 Setup

To set the VENTILATION MODE, perform a cold start. During the cold start, select the Ventilation Mode.

SETUP	
Ventilation Mode	PRECISION
Language	ENGLISH
Temperature Unit	F°
Static Pressure Unit	IN.W.C
Wind Speed Unit	METER/SEC
Fan Air Capacity Unit	CFM
Length Unit	NON METRIC
Weight Unit	LB
Minimum Vent (Power)	YES
Tunnel	YES
History Resolution	15 MINUTE

Set the following:

- Temperature Unit Celsius / Fahrenheit
- Static Pressure Unit Milibar / Inches of WC (Water Column) / Pascal / cm of WC / mm of WC / none
- Wind Speed Unit Km Per Hour / Mile per Hour / Meter per Sec / Feet per Sec
- Fan Air Capacity Unit Cubic feet per minute (CFM) / Cubic meter per hour (M3/H)
- Length Unit Meter / Feet

- Weight Unit Pounds (LB) / Kilograms (KG)
- Growing Zones 1/2/3/4
- Minimum Vent (Power) YES (power) / NO
- Tunnel YES / NO
- History Resolution 1 minute / 5 minute / 10 minute / 15 minute / 30 minute / 1 hour / 2 hours

10.2 Relay Layout

- Relay Layout Main Screen
- Output Function List

10.2.1 RELAY LAYOUT MAIN SCREEN

Use this screen to define the devices connected to the controller.

1. Select the requested choice from the menu list by using the up/down cursor keys (refer to Error! Reference source not found., page Error! Bookmark not defined.).
2. Repeat for each card.

NOTE If required, you can set the relay number manually.

3. If the required code is 100 and above, use the '+/-' keys before selecting and then press a two-digit number. For example 135 would be +/-35.
4. To duplicate relays use the 'As Relay # X' where 'X' stands for a relay number defined already in the system.

RELAY LAYOUT			
Relay	Function	Num	NO/NC
CARD 1			
1	< None >	0	-
2	< None >	0	-
3	< None >	0	-
4	< None >	0	-
5	< None >	0	-
6	< None >	0	-
7	< None >	0	-
8	< None >	0	-
9	< None >	0	-
10	< None >	0	-

RELAY LAYOUT			
Relay	Function	Num	NO/NC
CARD 1			
1	Vent Open	1	-
2	Vent Open	2	-
3	Vent Close	1	-
4	Vent Close	2	-
5	Heat	1	-
6	Heat	2	-
7	Curtain Open	1	-
8	Curtain Close	1	-
9	< None >	0	-
10	< None >	0	-

If you have installed Current Sense relays, Platinum Pro/Rotem Pro defines them automatically. Current sense relays transmit to the user's PC the amount of the current being passed to the relay and send alarms when the current is too low or too high. In addition, you can view the daily electricity consumption in History. Refer to - Sense Relay Calibration, page 98 for calibration instructions.

10.2.2 OUTPUT FUNCTION LIST

	Relay Name	Quantity Supported
1.	Heaters	16
2.	Radiant Heaters Low	16
3.	Radiant Heaters High	16
4.	Radiant Heaters Ignite	16
5.	Tunnel Fan	30
6.	Exhaust Fan	20
7.	Stir Fan	15
8.	Cooling Pad	4
9.	Fogger	4
10.	Vent Open	4
11.	Vent Close	4
12.	Tunnel Open	4
13.	Tunnel Close	4
14.	Attic Open	1
15.	Attic Close	1
16.	Vent Speed	1
17.	Light	4
18.	Water	4
19.	Feeder	4
20.	Auger	4
21.	Extra System	4
22.	Alarm (N.C.)	1
23.	Fail Safe (N.C.)	1
24.	Feeder Win Open	1
25.	Feeder Win Close	1
26.	Feeder Line Up	1
27.	Feeder Line Down	1
28.	Drink Line Up	1
29.	Drink Line Down	1
30.	Water Main	1
31.	Water Bypass	1
32.	Water Line	10
33.	WOD	4
34.	AS Relay	8
35.	AS Analog Output	8

10.3 Analog Sensors

This screen enables configuring the analog sensors. Platinum Pro/Rotem Pro regards temperature, humidity, CO2, light, and wind direction sensors as well as circuit breakers and potentiometers as analog sensors. These sensors measure a continuous range rather than just on or off.

ANALOG SENSORS		
In	Function	Num
CARD 1		
1	< None >	0
2	< None >	0
3	< None >	0
4	< None >	0
5	< None >	0
6	< None >	0
7	< None >	0
-	..	-



ANALOG SENSORS		
In	Function	Num
CARD 1		
1	Temp Sensor 1	1
2	Temp Sensor 2	2
3	Temp Sensor 3	3
4	Temp Sensor 4	4
5	Temp Sensor 5	5
6	Temp Sensor 6	6
7	Temp Sensor 7	7
8	Hum Sensor In1	1
9	Light Sensor	1
10	Potentiometer	1
Box 1	Slot 2	Channel 1

1. Select the requested choice from the menu list by using the up/down cursor keys.
2. Repeat for each card.

10.4 Digital Sensors

➤ Install digital input cards.

This screen enables configuring the installed digital sensors. These sensors monitor both water and feed consumption if the building is equipped accordingly. Digital inputs include on/off and pulsing inputs such as auxiliary alarms, pulsing water meters, cool pad/fogger water meter, wind speed sensors, and rain detectors.

DIGITAL SENSORS		
In	Function	
	CARD 1	
1	< None	<None>
2	< None	1. Water Meter
3	< None	2. Cool Pad Water Meter
4	< None	3. Fogger Water Meter
5	< None	4. Feed Count
6	< None	
7	< None	
8	< None	

DIGITAL SENSORS		
In	Function	No.
	CARD 1	
1	Water Meter	1
2	Auger - 1 Overtime	1
3	Cool Pad Water Meter	1
4	Fogger Water Meter	1
5	Water Meter	2
6	< None >	0
7	< None >	0

1. Enter sensor wired to each digital input card (setup according to technician).
2. Repeat for each card.
 - Platinum Pro/Rotem Pro automatically numbers the sensors according to their function.
 - You cannot define more than the permitted number of any particular sensor. For example, you can define one function as Cool Pad Water Meter, not two.

10.5 Analog Output

- Analog Output Main Screen
- Analog Output – Help | Set Definitions

10.5.1 ANALOG OUTPUT MAIN SCREEN

➡ Install analog output cards.

This selection controls light dimmers and variable speed fans. Select the desired 'Output Function' from the menu list and insert the approximate output voltages.

Analog Output				
Out Num	Function	Num	Min V.Out	Max V. Out
CARD 1				
1	Light Dimmer	1	0.0	10.0
2	Light Dimmer	2	0.0	10.0
3	< None >	0	1. Variable Speed 2. Light Dimmer 3. Var. Stir Fan 4. Var. Heater 5. Vent	
4	< None >	0		
5	< None >	0		
6	< None >	0		
7	< None >	0		
8	< None >	0		



ANALOG OUTPUT				
Out Num	Function	Num	Min V.Out	Max V. Out
CARD 1				
1	Light Dimmer	1	0.0	10.0
2	Light Dimmer	2	0.0	10.0
3	Variable Speed	3	0.0	10.0
4	Curtain	2	1.0	9.0
5	Vent	2	1.0	9.0
6	Tunnel	1	1.0	9.0
7	Tunnel	2	1.0	9.0
8	Var. Heater	1	0.0	10.0

1. Enter sensor wired to each analog output card (setup according to technician).
2. Repeat for each card.

- The above is an example of an analog output configuration.

10.5.2 ANALOG OUTPUT – HELP | SET DEFINITIONS

② While viewing the Analog Output menu: Press **HELP**, select **SET**, and press **ENTER**.

RELAY LAYOUT	
Max Fan Speed Output (Volt)	8.5

- **Max Fan Speed Output (Volt):** This parameter works as an override to the Maximum Voltage Output.

10.6 Vent/Curtain Setup

➡ In **Installation > Setup**, define **Static Pressure unit** as **None**.

Use this screen to define the ventilation opening and closing mechanism.

- Using Time to Calibrate
- Using a Potentiometer to Calibrate
- Vent/Curtain Help | Set Definitions

If you map a curtain or vent to a potentiometer, Platinum Pro/Rotem Pro uses that method (and not time).

10.6.1 USING TIME TO CALIBRATE

Enter the number of seconds to open and close from limit to limit for each of the Vents and Curtains in your installation. The Platinum Pro/Rotem Pro then calculates the percentage of open and closed time and adjusts the static pressure methods accordingly.

VENT/CURTAIN SETUP				
Curtain	Pot	Open (sec)	Close (sec)	
~ Tunnel 1	NONE	60	60	
~ Vent 1	NONE	60	60	
Vent 2	NONE	60	60	
Attic 1	NONE	60	60	

Set full open/full close time (in seconds) for Curtains, Tunnel, 1st & 2nd Vent, and Attic Vent.

NOTE Default is set at 60.

NOTE The ~ symbol designates an analog output device.

10.6.2 USING A POTENTIOMETER TO CALIBRATE

Each vent can be mapped to a potentiometer. Potentiometer feedback enables precise positioning on each specific device opening value. In this screen, assign a potentiometer to a device.

VENT/CURTAIN SETUP			
Curtain	Pot	Open (sec)	Close (sec)
~ Tunnel 1	POT 1	60	60
~ Vent 1	POT 2	60	60
Vent 2	NONE	60	60
Attic 1	NONE	60	60

1. Map the analog sensors as potentiometers as required (- Sensors, page 103)
2. Map the vent/tunnel to a potentiometer in this screen.

NOTE The number of the devices that you can map equals the number of potentiometer relays.

NOTE The ~ symbol designates an analog output device.

3. Calibrate the potentiometer (- Calibration, page 90).
4. Set the help parameters as required.

NOTE After calibrating the potentiometer, the times shown here change to reflect the calibration process.

In the event that the potentiometer fails (meaning there is no value change during the curtains/vents/inlets movement):

- Alarm message is transmitted
- The specific curtain/vent/inlet mapped to the failed potentiometer starts operating by time calculation, using the times calculated by the calibration process. However, if required you can enter new opening and closing times.

10.6.3 VENT/CURTAIN HELP | SET DEFINITIONS

These parameters enable maintaining an accurate curtain position when using time to calibrate.

- ② *While viewing the Vent/Curtain menu: Press HELP, select SET, and press ENTER.*

SYSTEM PARAMETERS	
CURTAIN CALIBRATION	
From Time	0:00
To Time	0:00
Number of Steps	0
Power Vents Calibration	NO
Proximity to Edge %	10
Close Below This Temp. (out)	0.0

- From/To Time: Time period in which calibration is enabled

- **Number of Steps:** number of steps for automatic calibration: Set calibration point for curtain after desired amount of curtain opening/closing (steps). During calibration, if the curtain is open more than 50% it opens to 100%, calibrates, and returns to the previous position. If the curtain is open less than 50% it closes to 0%, calibrates, and returns to the previous position. Default: 99.
 - **Power Vents Calibration:** This parameter enables automatic calibration of air inlets when recovering from a power outage. In many installations the backup system, such as Munters' FBU-27, may have opened the air sources. When the Platinum Pro/Rotem Pro takes over control again, the air inlets are incorrectly positioned. The calibration at power up feature synchronizes the actual position and the controller.
 - **Proximity to Edge %:** Curtain will open or close based on this proximity to the edge. For example, when set to 10%, the curtain closes when the opening is less than 10% and opens completely when the opening is greater than 90%.
 - **Close Below This Temp. (out):** Curtains close when the outside temperature reaches this point.
- This parameter requires defining a temperature sensor as an outside sensor (refer to [_ Definition](#)).

NOTE The Proximity to Edge % parameter takes priority over the Close Below This Temp parameter. Meaning, if the outside temperature mandates closing the curtain, the curtains will still open if they are within the proximity defined in the Proximity to Edge parameter.

10.7 Temperature Definition

This menu assigns specific temperature sensors for various brood setups and for heater zones. Moreover, assigning sensors to particular devices is possible. Note that if the sensors selection remains blank, the default value is assigned.

Choose 1 to 18 temperature sensors for each item listed by using the '+'/'-' keys. The house, brooding and tunnel sensors cause the current average to apply to devices when no specific sensor is assigned to them. The current average substitutes for either failed or missing sensors.

TEMPERATURE DEFINITION	
Function	Temp. Sensor
	1 2 3 4 5 6 7 8 9
FULL HOUSE	√√√ • • • • •
TUNNEL SETTING	• • • • • • • • •
ATTIC	• • • • √ • • • •
OUTSIDE	• • • • • √ • • •

- Press +/- key to add/remove ✓ to assign temperature sensors to corresponding function.

NOTE If you are using two (2) input analog cards, the screen displays Temp. Sensor(s) 1-18 (refer to above screen capture).

NOTE When an attic sensor is not installed, the attic vent is disabled.

Assign Temperature Sensors as required in Install | Temp Definition. Devices that do not accept temperature sensors, such as Exhaust Fans, Tunnel Fans, Feed and Light do not appear.

10.8 Fan Air Capacity

This option enables defining the capacity of fans air. Insert fan air capacity for both the exhaust and tunnel fans. The units are as chosen in INSTALL | SETUP.

FAN AIR CAPACITY	
Fan	CFM
Tun. Fan 1	24600
Tun. Fan 2	24600
Tun. Fan 3	29400
Tun. Fan 4	29400
Tun. Fan 5	29400
Tun. Fan 6	29400
Tun. Fan 7	29400
Tun. Fan 8	29400
Tun. Fan 9	29400
Tun. Fan 10	29400

- Define air capacity for exhaust/tunnel fans (default setting shown above).

NOTE This information enables the display of air capacity for each level in the Levels of Ventilation table (Precision ONLY).

10.9 House Dimensions

The selection allows the user to set its' house dimensions. Set it according to actual house size. These dimensions are used for calculating the wind chill factor (the chilling effect of the wind that can significantly lower the temperature).

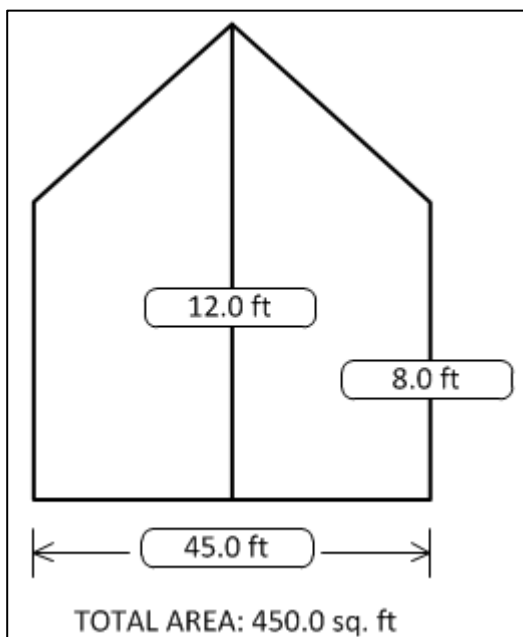

- Define height, width, and length of house (Controller calculates total area).

NOTE This information enables the calculation of the Wind Chill factor displayed in Hot Screen Key = 2 (Tunnel mode ONLY).

10.10 Communication

This menu defines the communication baud rate.

COMMUNICATION SETUP	
Baud Rate	9600
House Number	1
	1200
	2400
	9600
	19200
	38400

- **Baud rate:** This parameter is a measure of the communication speed for local or remote communications to a PC. The default is 9600 represents a data rate of approximately 1000 characters per second. If the connection fails at this speed, try a lower speed.
- **House number:** Each controller on a network must have a unique number so Munters' communications software can distinguish individual controllers. Note that these numbers are from 1 to 64.

11 Appendix A: Output Data

Table 1: Sensor Readings

Sensor	Definition
Temp	Displayed with the specific sensor number
Out T.	Outside temperature
Press.	Pressure
Hum. In	Inside humidity
Hum. Out	Outside humidity
Weight	Average weight
Weights	Number of weights
Breaker	Circuit breaker

Table 2: Output List (Active)

Output	Definition
Alarm	Can be either active or not. Note that this always appears last.
Heat	Indicates operating heat number.
Heat. Hi	Indicates operating heat high number.
Tun. Fan	Indicates operating tunnel fan number.
Exh. Fan	Indicates operating exhaust fan number.
Stir	Indicates operating stir fan number.
Cool P.	Indicates operating cool pad number.
Fogger	Indicates operating fogger number.
Inlet	
Tunnel	
Curt.	Mentions opening percentage
Ext. Sys	Indicates operating external system number.
Light	Note that these mention output percentage
Water	Indicates operating water number.
Feed	Indicates operating feed number.
Auger	Indicates operating auger number.
Rad. Lo	Indicates operating radiant heat low number.
Rad. Hi	Indicates operating radiant heat high number.

Table 3: Status Readings

Status	Definition
Time	Specific time
Day	Growth day
Set	Target temperature
Offset	Temperature Curve HELP SET parameter
House mode	Control Mode HELP SET parameter
Level	Level number
Tunnel, Natural, Min. Vent	The controller's state
Fan Off	How long the cycle ends its' operation
Fan On	How long the cycle begins its' operation
Curve off	Occurs when located in low curve temperature or when the Control Mode HELP SET 'Temperature Curve' parameter is set to OFF.
Hum. Treat	Indicates when occurs
Cool flush	Indicates when occurs
Nip. Flush	Indicates when occurs

Table 4: Events

Event	Event Explanation
Power Off	Appears when power is off.
Power On	Appears when power is on.
Cold Start	Appears when cold start is done.
Change level to vent	Changes according to a specific stage
Backup set reminder	HELP SET: 'Set Temp. Change remainder (diff)' parameter
Alarm on	Appears when the alarm is on.
Change in setting	
Change in switches	
New flock	Appears when new flock is being updated.
Reset alarm	Appears when reset alarm is done.
System message #	For Munters' technicians only.
Alarm card fail	Appears when the alarm card fails
Digital card fail	Appears when the digital card fails
Memory restore	Appears when the system does restore cause by noises.
Minimum ventilation	Appears when minimum ventilation occurs.
Natural ventilation	Appears when entering natural ventilation.
Tunnel ventilation	Appears when entering tunnel ventilation.
Alarm test	Appears when alarm test is done.
Precision mode	
Standard mode	

Event	Event Explanation
Changed growth day	Appears when changing the growth day occurs.
MinV L.P Alarm Dis.	Appears when minimum low-pressure alarm is being disabled.
MinV L.P Alarm Ena	Appears when minimum low-pressure alarm is being enabled.
Tun. L.P Alarm Dis.	Appears when tunnel low pressure alarm is being disabled.
Tun L.P Alarm Ena.	Appears when tunnel low pressure alarm is being enabled.
Visitor Log in	Appears when the visitor logs in with his password.
User #1-5 log in	Appears when the user logs in with his password.
Owner log in	Appears when the owner logs in with his password.
Change Visitor pass	Appears when the visitor changed his password.
Change User #1-5 pass	Appears when the user changed his password.
Change Owner pass	Appears when the owner changed his password.
Data read from plug	Appears when data is being read from plug.
System recover	Appears when the system tries to recover itself, in cases such as noises.
System lock	Appears when either using the correct password, or when using hot key '9,' or automatically after 5 minutes.
Empty house mode	Appears when setting at a specific time.
Version 6.23	
Ref Weight Change	Appears when Curve Offset is manually changed in Scale > Bird Weight > Settings. Change can be a different curve, gender, or offset.
Factor Change	Appears when Factor is manually changed in Scale > Calibration.
Scale or Silo Calibration	Appears when silos/scales are manually calibrated in Scale > Calibration.

12 Appendix B: Breeder Mode

- Egg Room Setup
- Egg Counter
- Egg Room Water and Feed
- Egg Belt Runtime
- Egg Room Hot Screen
- Nest Function
- Scale Arm
- Weighing the Birds in Breeder
- Breeder Advanced Feeding
- Egg Room History
- Egg Room History

CONTROL	
1. TEMPERATURE CURVE	
2. HUMIDITY TREATMENT	
3. MINIMUM VENT. TIMER	
4. TIMER SETTINGS	
5. STATIC PRESSURE	
6. CONTROL MODE	
7. SYSTEM PARAMETERS	
8. EGG ROOM	
9. WORK ROOM	
10. CO2 TREATMENT	

SENSORS		AV. TEMP.		ACTIVE	
Temp1	37.9°	27.5°		Heat	1
Temp2	16.2°	STATUS		Heat. Hi	1
Temp3	28.2°			Tun. Fan	
F.Wgt	3.21	08:53:06		Exh. Fan	
M. Wgt	3.33	Day: 2		Stir	
Press.	23	Set:	25.0	Cool P.	
Out T.	23.9°	Level:	3	Fogger	
Hum. In	58.7%	Min.	Vent	Curt. 1	100%
Hum. Out	61.9%	FanOff:	176	Curt. 2	100%
4 MESSAGES				Feeder	
				Auger	
				Valve	

12.1 Egg Room Setup

The following procedures details the steps required to set up the Egg Room functions.

1. In *Install > Relay Layout*, define five relays as:
 - Egg room heater
 - Egg room fan 1
 - Egg room fan 2
 - Egg Room Cool
 - Humidifier

RELAY LAYOUT			
Relay	Function	Num	NO/NC
1	Hum. Egg Room Sensor	1	-
2	Egg Room Cooling	1	-
3	Egg Room Heater	1	-
4	Egg Room Fan	2	-
5	< None>	1	-
6	< None>	2	-
7	< None>	1	-
8	< None>	1	-
10	< None>	9	< None>

NOTE Refer to Relay Layout, page 102 for details on this screen.

2. In *Install > Analog Sensors*, set the input functions as Temperature Sensors and as an Egg Room Humidity sensor

NOTE Refer to *Sensors*, page 103 for details on this screen.

3. In *Install > Temperature Definition*, configure which temperature sensors operate in the egg room.

TEMPERATURE DEFINITION									
Function	Temp. Sensor								
	1	2	3	4	5	6	7	8	9
Full House	√	√	√	*
Tunnel setting
Attic	√
Outside	√
Egg Room	√
Work Room	√
Feed Area

NOTE Refer to Temperature Definition, page 109 for details on this screen.

NOTE After defining egg room temperature sensors, the egg room temperature appears on the main screen.

SENSORS	
Temp1	37.9°
Temp2	16.2°
Temp3	28.2°
E. Tmp1	28.8°
E. Tmp2	28.4°
Egg Room	28.4

4. In *Service > Humidity Calibration*, calibrate the Egg Room humidity sensor.

HUMIDITY CALIBRATION		
Sensor	Humidity°	Factor
In-1	58.9	2.3
In-2	58.9	2.3
Out	N/A	---
Egg Room	67	2.0

Press Left/Right Arrows to Calibrate

NOTE Refer to Humidity Calibration, page 87 for details on this screen.

5. In *Control > Egg Room*, set the following on/off parameters:

- Heater temperature
- Fan 1 temperature
- Fan 2 temperature
- Cooling temperature
- Humidifier relative humidity percentage

EGG ROOM CONTROL		
Function	On	Off
Heater Temp	62.0	66.0
Fan 1 Temp	70.0	66.0
Fan 2 Temp	70.0	66.0
Cooling Temp	74.0	70.0
Humidifier %rh	65	70

6. In *Control > Egg Room > Help > Set*, configure the following alarm parameters:

- Low Temperature
- High Temperature
- Low Humidity
- High Humidity
- Delay (minutes)

EGG ROOM	
ALARM	
Low Temp	62.6
High Temp	71.6
Low Humidity	70
High Humidity	80
Delay (minute)	60

The Breeder Mode is configured.

12.2 Egg Counter

Platinum Pro/Rotem Pro Breeders Mode supports up to four egg counters per house. Platinum Pro/Rotem Pro supports Accucount infra-red egg counters (refer to the Egg Counter manual for details). The following sections detail the setup.

1. In *Install > Digital Sensors*, define up to four Egg Counters.

DIGITAL SENSORS		
In	Function	Num
1	Water Meter	1
2	Auger - 1 Overtime	1
3	Cool Pad Water Meter	1
4	Egg Counter	1
5	Egg Counter	2
6	Egg Counter	3
7	Egg Counter	4

2. Set the Alarms (refer to Alarm Setting Help | Set Definitions, page 59 for details on how to set alarms).

- **Low Feed Alarm Limit:** Alarm if feed in Silo 1-8 is below this limit and time is between From and To limits.

Egg Counter Alarm

- **Alarm Active From/Until:** Set the period for which the controller generates alarms.
- **Low Egg House Count Eggs/Minute:** Define the number of eggs per minute at which an alarm is generated.
- **Low Count Alarm Delay (min):** Set the minimum period of time low egg count must extend through before generating an alarm

3. The Main Screen displays the current day's total egg count.

SENSORS		AV. TEMP.	ACTIVE
Eggs 1	500	27.5°	
Eggs 2	50		
Eggs 3	300		
Eggs 4	400		
		STATUS	
		08:53:06	
		Day: 2	
		Set: 25.0	
		Level: 3	
		Min. Vent	
		FanOff: 176	
4 MESSAGES			
Low Egg Count House 2			

4. To test the egg counter sensor(s), go to *Test > Digital Sensors*.

DIGITAL IN TEST			
In.	Sensor	State	Counter
1	Egg Counter 1	1	0
2	Egg Counter 2	0	0
3	Egg Counter 3	0	0
4	Egg Counter 4	0	0
5	<None>	0	0
6	<None>	0	0
7	<None>	0	0
8	<None>	0	0

5. To view the cumulative egg count, go to History > Eggs.

EGGS				
Day.	1	2	3	4
1	524	457	567	345
2	567	455	587	350
3	0	0	0	0
4	0	0	0	0
5	0	0	0	0
6	0	0	0	0
7	0	0	0	0
8	0	0	0	0

12.3 Egg Room Water and Feed

In Breeder Mode, the water and feed schedule is independent of the growth day. In addition, Breeder Mode enables lowering the target temperature during the feeding time. When birds begin to feed, they congregate near the feeders and the temperature rises (which negatively affects the birds' feed intake). To compensate, increase the ventilation before/during the feeding time by lowering the target.

12.3.1 SETUP

1. Go to Device > Water & Feed.

WATER & FEED							
Time		Water		Feeder		Auger	
From	To	1	2	1	2	1	2
4:00	4:30	●	■	●	■	●	■
4:45	5:15	●	■	●	■	●	■
5:00	5:30	●	◐	■	◐	●	◐
7:00	8:00						
0:00	0:00						
0:00	0:00						
0:00	0:00						
0:00	0:00						
0:00	0:00						
0:00	0:00						

NOTE When using Breeding Advanced Feeding, Auger does not appear.

2. Set the parameters as required:

- Time: Set event times for water, feeder, or auger.
- Set the water, feeder, and auger lines to Continuous, Cycle, or Off.

3. In Install > Setup, define Feed Area as Yes.

NOTE If you do not define Feed Area as Yes, Feed Area does not appear in Temperature Definition.

4. In Install > Temperature Definition, map a temperature sensor(s) to the feed area (optional).

TEMPERATURE DEFINITION									
Function	Temp. Sensor								
	1	2	3	4	5	6	7	8	9
Full House	√	√	√	*
Tunnel setting
Attic	√
Outside	√
Egg Room	√
Work Room	√
Feed Area	.	.	.	√	√

5. Go to Device > Water & Feed > Help.

WATER & FEED	
TEMP TARGET ADJUST	
Change Target From:	4:45
Change Target To:	8:00
Temp Target Offset:	-5.0
FEED LINE OPERATION	
Line 1 Down (hh:mm)	4:45
Line 1 Up (hh:mm)	5:00
Line 2 Down (hh:mm)	4:45
Line 2 Up (hh:mm)	5:00
WATER CYCLE TIME	
Cycle On	30
Cycle Off	270
FEEDER CYCLE TIME	
Cycle On	60
Cycle Off	200

NOTE When using Breeding Advanced Feeding, Auger Cycle Time does not appear. Refer to Breeder Advanced Feeding, page 128.

6. If a device is set to Cycle, define the Water/Feeder/Auger On and Off times.
7. To adjust the target temperature during feeding (to increase ventilation):
 - a. Define the To/From times.
 - b. Define the Target Temperature Offset (to reduce the target).

NOTE To disable this feature set the offset to 0.

8. To control the male breeders feeding time:
 - a. Under Feed Line Operation, define when the lines descend and rise (Line Down, Line Up times).
 - b. Go to Service > Feed Line Calibration.
 - c. Enter the amount of time required for the curtains to rise and descend.

NOTE Measure these times if you do not know them.

FEED LINE CALIBRATION	
Function	Run Time (sec).
Feed Line 1 Up	60
Feed Line 1 Down	50
Feed Line 2 Up	80
Feed Line 2 Down	40

Additional points:

- In Breeder Mode, Platinum Pro/Rotem Pro supports up to:
 - 10 feeders
 - Four water lines
 - Four augers

Define these functions in Install > Relays.

- To and From times can overlap. For example, in the table above one line goes from 4:45 to 5:15 and the next line goes from 5:00 to 5:30. If there is overlap and contradictory configurations, the priority is Continuous > Cycle > Off. In the example above:
 - Water Line 2 will run in a cycle from 5:00 until 5:30.
 - Feeder Line 1 will be on 4:45 until 5:15, even though the line 3 turns off the feeder.

12.3.2 WATER AND FEED VERSION 6.24 AND ABOVE

When running Platinum in Breeder Basic Mode, Version 6.24 and above Water, Feeder, and Auger Tables appear in separate windows; each window can be configured independently. The functionality and configuration are the same as in Version 6.23.

WATER			
Time		Water	
From	To	1	2
4:00	4:30	●	■
4:45	5:15	●	■
5:00	5:30	●	◐
7:00	8:00		
0:00	0:00		
0:00	0:00		
0:00	0:00		
0:00	0:00		

FEEDER			
Time		FEEDER	
From	To	1	2
4:00	4:30	●	■
4:45	5:15	●	■
5:00	5:30	●	◐
7:00	8:00		
0:00	0:00		
0:00	0:00		
0:00	0:00		
0:00	0:00		

AUGER			
Time		Auger	
From	To	1	2
4:00	4:30	●	■
4:45	5:15	●	■
5:00	5:30	●	◐
7:00	8:00		
0:00	0:00		
0:00	0:00		
0:00	0:00		
0:00	0:00		

12.4 Egg Belt Runtime

Breeder Mode supports measuring the egg belt runtime.

- Install digital input cards.
 1. Go to *Install > Digital Sensors*.

DIGITAL SENSORS		
In	Function	Num
1	Water Meter	1
2	Auger - 1 Overtime	1
3	Cool Pad Water Meter	1
4	Fogger Water Meter	1
5	Water Meter	2
6	Feeder Over Time	1
7	Egg Belt	1
8	< None >	0

2. Define a sensor as Egg Belt.
3. Go to History > Egg Belt Run Time to view the data.

12.5 Egg Room Hot Screen

The Breeder Mode supports the following additional Hot Screen:



Egg Room Status. This screen displays the current temperature, relative humidity, and readings from the five relays.



Bird Scale: Bird Scale Hot Screen displays weight according to gender (if scales are defined as both male and female)

12.6 Nest Function

The Nest function enables opening and closing (up to) four Nest lines at specific times. Birds can then leave their Nests and return.

In Version 6.19, the nest function operates in two different manners, depending on the number of relays required to open and close the nests.

- Single Relay
- Dual Relay

12.6.1 SINGLE RELAY

When using a single relay:

- applying electricity opens the cages
- ceasing the electricity closes the cages.

The user defines when the relay opens (allows current) and when the relay closes (ceases current), thereby opening or closing the cage.

1. In Installation > Relay Layout designate up to four relays as Nest Open relays. The number of defined relays is what appears in the screen.

NOTE *In this setup there is no need to designate relays as Nest Close.*

2. In Device > Nest > Set Definitions, define the Nest Mode as Single (default is Dual).

SYSTEM PARAMETERS	
NEST	
Nest Mode	Single
Dual Mode	
Open Duration Time (sec)	30
Close Duration Time (sec)	30

3. In Device > Nest, define the:

- Time: This schedules when the relay enables or disables current to flow (daily).
- Nest: Under each nest, define if it opens or closes.
 - ∙: Cage closes
 - √: Cage opens

In the example below, Nests 3 and 4 open at 12:00 and close at 15:00. Nests 1 and 2 open at 15:00 and remain open until 12:00 the following day.

Nests		
Num	Time hh:mm	Nest 1 2 3 4
1	12:00	∙ ∙ √ √
2	15:00	√ √ ∙ ∙
3	0:00	∙ ∙ ∙ ∙
4	0:00	∙ ∙ ∙ ∙

12.6.2 DUAL RELAY

When using dual relays, one relay opens the cage and second closes the cage. A specific command must be given for each function. Cages remain open or closed until a command is given to change the status.

1. In Installation > Relay Layout designate up to four relays (each) as Nest Open and Nest Close relays. The number of defined relays is what appears in the screen.
2. In Device > Nest > Set Definitions, define the Nest Mode as Dual (default is Dual).

SYSTEM PARAMETERS	
NEST	
Nest Mode	Dual
Dual Mode	
Open Duration Time (sec)	30
Close Duration Time (sec)	30

3. Define the time required to open or close the cage.

4. In Device > Nest, define the:

- Time: This schedules a relay is activated.
- Nest: Under each nest, define which relay operates on a nest.

- O: Nest opens
- C: Nest closes
- ∙: No action (relay is closed or released)

In the example below, Nests 3 and 4 open at 12:00. Nest 2 opens at 15:00. Nest 3 closes at 16:00, while Nests 2 and 4 remain open.

Nests					
Num	Time hh:mm	Nest			
		1	2	3	4
1	12:00	∙ ∙	O		
2	15:00	∙	O	∙ ∙	
3	16:00	∙ ∙	C	∙	
4	0:00	∙ ∙ ∙ ∙			

12.7 Scale Arm

During feed distribution, each silo has a mechanical arm that disconnects at the end of a feed cycle, preventing further distribution. When this disconnect happens, a signal is sent from the arm to the silo, informing the latter that it must be refilled. Platinum Pro/Rotem Pro enables recording these signals in the Events History.

To define the Scale Arm:

1. Go to Install > Digital Sensors.
2. Define one sensor as Scale Arm.

DIGITAL SENSORS		
In	Function	Num
1	Scale Arm	1
2	< None >	0
3	< None >	0
4	< None >	1
5	< None >	0
6	< None >	0
7	< None >	0
8	< None >	0

- In History > Table of Events, Feed Delivered appears when the mechanical arm disconnects.

TABLE OF EVENTS			
	Event	Day	Time
1	Feed Delivered	1	13:27:05

12.8 Weighing the Birds in Breeder

The following section details how to set up scales to weigh the birds. In Versions 6.22 or above, setting up a bird curve means defining the following items in the Scale Menu:

- **Scale Card:** Define at least one scale.
- **Bird Scale Setting:** Define the curve type (Auto, Custom, or Factory Curve)
- **Bird Weight:** Define the reference weight or curve data points (day and weight).

1. Go to Scale > Scale Layout. Use Scale Layout to define the scales or silos connected to the controller.

NOTE A scale card must be installed in the controller or an RSU-2 unit must be connected to the controller for these screens to appear.

Platinum Pro/Rotem One supports the RSU-2 and two types of scale cards:

- Two channel scale cards: Supports bird scales only.
- Six channel scale cards: Supports bird and silo. The controller can support up to ten weighing channels.
- Refer to the installation manual regarding Munters' recommendations regarding these options.

SCALE LAYOUT		
Scale Card		
Chan.	Function	No.
1	Silo 1	1
2	Silo 2	2
RSU 1		
1	Silo 3	3
2	Silo 4	4

SCALE LAYOUT		
Ch.	Function	No.
Scale Card		
1	Scale	1
2	Scale	2
3	Silo	1
4	Silo	2
5	Feed Scales	1
6	Scale	3
RSU 1		
1	Silo 3	3
2	Scale 3	3

<None>
 1. Scale
 2. Silo
 3. Feed Scales

Figure 12: Two Channel Layout

Figure 13: Six Channel Layout

2. Go to Scale Menu > Bird Scale > Help. Select Auto or Manual.

BIRD SCALE SETTING	
Range Method	Auto Manual

This parameter defines which measured bird weights are used in calculating the actual curve. Bird weights that are outside of the band are discarded.

- If you select Auto, Platinum calculates the band of acceptable weights.
- If you select Manual, define the female/male upper and lower weight ranges.

BIRD SCALE SETTING	
Range Method	Manual
Female	
Upper Range [%]	10
Lower Range [%]	15
Male	
Upper Range [%]	15

3. Go to Scale Settings > Bird Scale.

BIRD SCALE SETTING	
Weighing Method	Auto
Scale 1	Female
Scale 2	Female
Scale 3	Female
Scale 4	Female

Auto
 Curve
 Auto Turkey

- Define the weighing method: Auto, Curve, Auto Turkey. Curve includes a user-defined curve option and industrial standard curve options.
 - Version 6.24:
 - Define each scale as male, female, or male and female.
 - Define the time period during which weight data is collected.

BIRD SCALE SETTING	
Weighing Method	Auto
Scale 1	Female
Scale 2	Male
Scale 3	Male&Female
Scale 4	Female
From Time	12:00
To Time	15:00

- Define each scale as female or male.
- Auto or Auto Turkey Curve
- Customized/Industrial Standard Curves

12.8.1 AUTO OR AUTO TURKEY CURVE

- Go to Scale > Bird Weight.
 - If you selected Auto or Auto Turkey in Bird Scale, edit the weights as required; weights are automatically updated.

BIRD WEIGHT	
Current Female Weight	0.09
Current Male Weight	0.09

- If you selected Curve in Bird Scale, the male and female curves are displayed.

BIRD WEIGHT		
Day	Female	Male
0	0.00	0.00
7	0.00	0.00
14	0.00	0.00
21	0.00	0.00
28	0.00	0.00

12.8.2 CUSTOMIZED/INDUSTRIAL STANDARD CURVES

1. Go to Scale > Bird Weight > Help.

SYSTEM PARAMETERS	
Female	
Curve Offset	0.00
Select Curve	Custom
Male	
Curve Offset	0.00
Select Curve	CobbMV

2. For female and male, enter the factor used to adjust the weight curve. This amount is added to the Reference weight field. Range: 0.0 – 10.0 Kg/Lb.

3. For female and male, select the required curve from the drop-down list.

4. Go to Scale > Bird Weight.

BIRD WEIGHT		
Day	Female	Male
0	0.09	0.09
7	0.35	0.33
14	0.62	0.75
21	0.88	1.16
28	1.15	1.53

- If you selected Custom, you can edit the curve.
- If you selected an industrial standard curve, the curve is read only.

12.8.3 BIRD WEIGHT HISTORY

The scale history shows bird weight statistics for female and male houses. You can review daily data for each gender or for each scale.

HISTORY							
Day	Female.	Uniformity	No.	Male	Unif.	No.	
1	0.00	0.00	0.00	0.00	0.00	0.00	
2	0.00	0.00	0.00	0.00	0.00	0.00	
3	0.00	0.00	0.00	0.00	0.00	0.00	

12.9 Breeder Advanced Feeding

Breeder Mode supports a unique feed mixing and distribution system that includes:

- Mixing feed from up to eight silos
- Distributing the feed to up to eight different feed lines
- Differentiating between male, female, or mixed sex flocks
- Support for up to 24 feeding stations (16 female and 8 males)
- Support up to eight overtime digital inputs

In this system (up to eight) silos place their feed onto auger lines, which transports the feed to a feed scale container. The feed is mixed in the feed scale container and then placed into hoppers, from which the feed is transported to the birds. What is unique in this program is the flexibility in designing feeding lines for male, female, and mixed lines. Using the Platinum Pro/Rotem Pro program, you define the entire feeding program:

- mapping silos to augers
- how much feed from each silo
- what type of feeding program to use
- which feeding stations are active

How does it work?

- Silos deliver feed to the feed scale container; the user defines how much feed each silo delivers (in percentages of the total weight).
- After delivering the feed, the silo augers are turned off and feed is placed in the hopper from which the feed is then placed into feed lines.
- Each hopper delivers feed to one or two lines:
 - If one feed line is used it can supply to feed to males, females, or both.
 - If two feed lines are used, one line is designated for the males and one line is designated for females
- When the hopper empties, the process repeats itself until the supplied feed equals the defined target.
- Continuous feeding: In standard feeding, the feed line hoppers are filled serially. A line hopper valve does not open until the previous valve closes. In the advanced feeding mode, you can configure the setup to ensure that the delays between the feed line hopper fillings overlap.

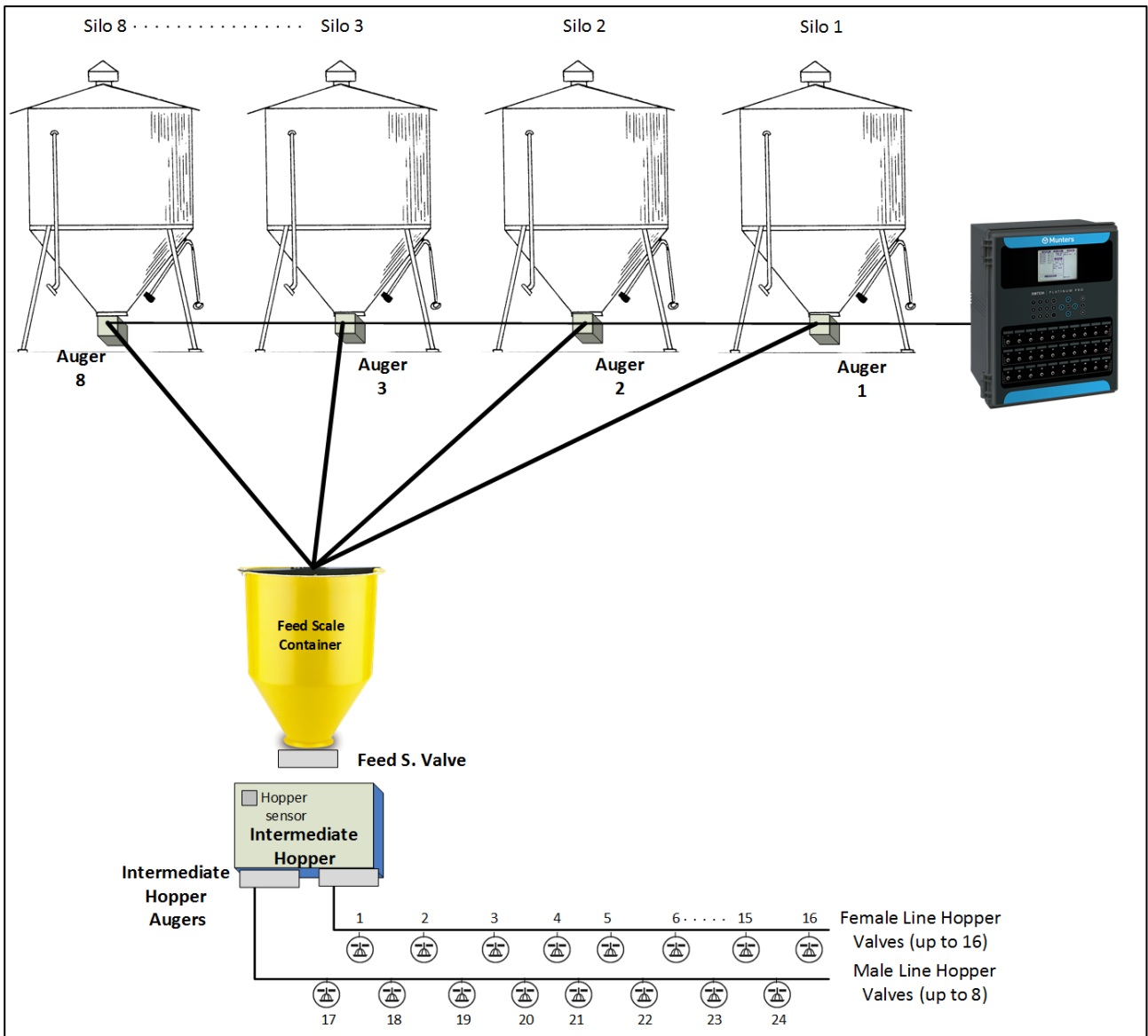

Figure 14: Dual Line Block diagram

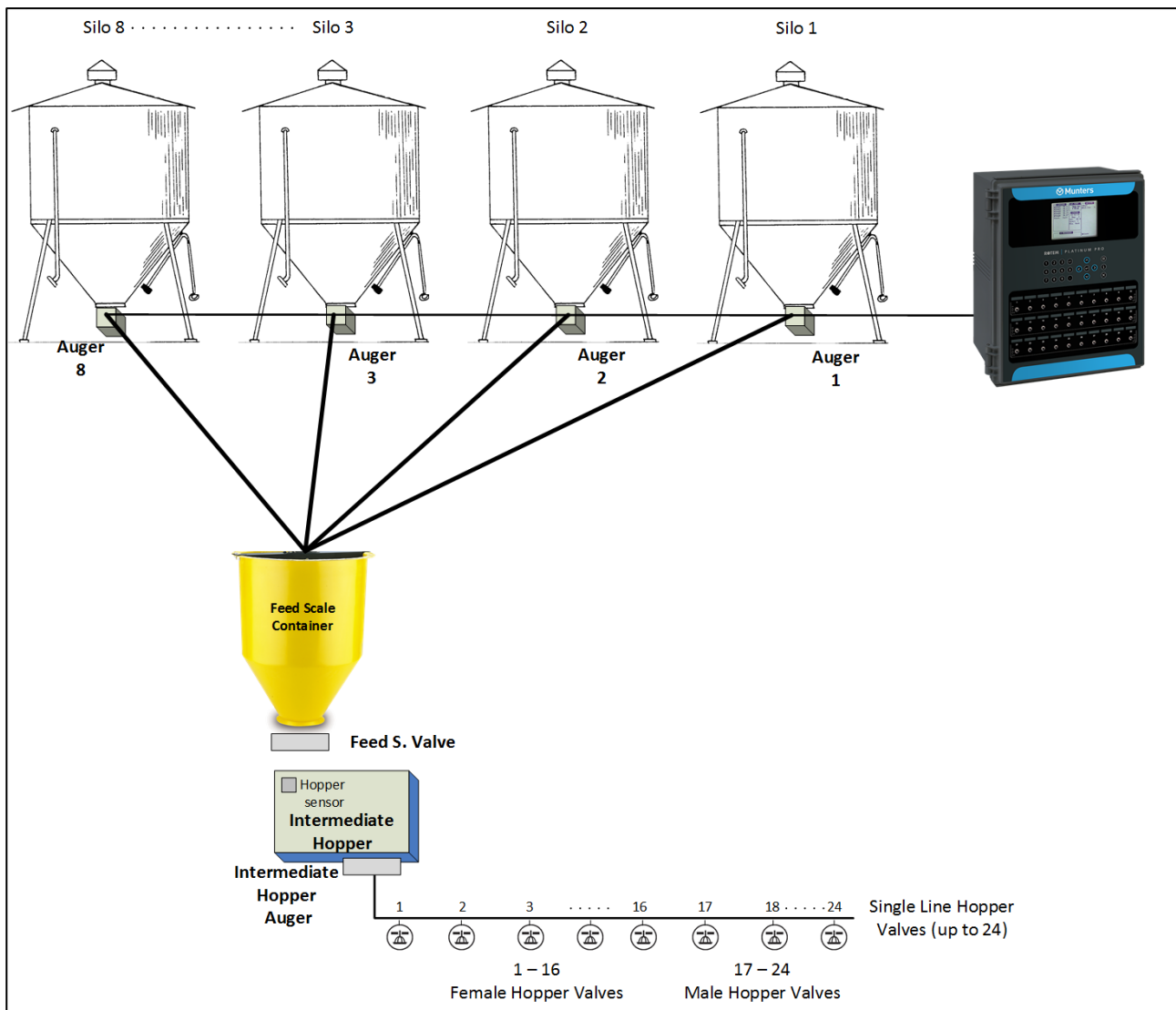

Figure 15: Single Line Block diagram

12.9.1 SELECTING THE ADVANCED FEEDING MODE

To enable the Breeder advanced feeding mode:

1. Disconnect the power cable from the power source.
2. Reapply power while pressing Delete. The Cold Start screen appears.
3. Select Yes. The Choose Controller Type appears.
4. Select the Breeder.
5. Select Precision.
6. Select Advanced Feeding.
7. Press Enter.

12.9.2 ADVANCED FEEDING SETUP

WARNING! Do not configure these screens while a feeding cycle is in progress.

1. Go to Installation > Relays.

RELAY LAYOUT			
Relay	Function	NO.	NC
CARD 1			
1	Auger	1	-
2	Auger	2	-
3	Auger	3	-
4	Auger	4	-
5	Auger	8	-
6	Auger	5	-
7	Auger	6	-
8	Auger	7	-
9	Line Hopper Valve	1	-
10	Inter. Hopper Auger	2	-
N.O. Relay			

2. Define:

- Up to eight relays as augers. This are the main silo augers.
 - As an option, you can manually number the augers.
- One feed scale valve (Version 6.22)
- Up to two intermediate hopper augers (male, female, both)
- Up to 24-line hopper valves.
 - Platinum Pro/Rotem Pro defines line hopper valves 1 – 16 as being female line hopper valves and valves 17 – 24 as being male line hopper valves.
 - If you are not using all 16 female valves or all 8 male valves, you can manually number the valves. For example, four valves can be numbered as 1 – 4 and the fifth valve numbered as 17.
 - Number the female and male valves sequentially. For example:
 - 1 – 4 or 5 - 7 and 17 – 20 or 21 - 24 are fine.
 - 1, 4, 7, 9 and 17, 21, 24 is incorrect.

3. Go to Installation > Digital Sensors and define up to eight auger overtime sensors.

DIGITAL SENSORS		
In	Function	No.
CARD 1		
1	Augur Overtime	1
2	Augur Overtime	2
3	Augur Overtime	3
4	Augur Overtime	4
5	Augur Overtime	5
6	Augur Overtime	6
7	Augur Overtime	7
8	Augur Overtime	8
Box 1	Slot 2	Channel 1

4. Go to Device > Water & Feed.

WATER & FEED					
Time		Water		Feeder	
From	To	1	2	1	2
4:00	4:30	●	■	●	■
4:45	5:15	●	■	●	■
5:00	5:30	●	◐	■	◐
7:00	8:00				
0:00	0:00				
0:00	0:00				
0:00	0:00				
0:00	0:00				

5. Set the parameters as required:

- Time: Set event times for water or feeder.
- Set the water or feeder lines to Continuous, Cycle, or Off.

6. Go to Device > Water & Feed > Help.

WATER & FEED	
TEMP TARGET ADJUST	
Change Target From:	4:45
Change Target To:	8:00
Temp Target Offset:	-5.0
FEED LINE OPERATION	
Line 1 Down (hh:mm)	4:45
Line 1 Up (hh:mm)	5:00
Line 2 Down (hh:mm)	4:45
Line 2 Up (hh:mm)	5:00
WATER CYCLE TIME	
Cycle On	30
Cycle Off	270
FEEDER CYCLE TIME	
Cycle On	60
Cycle Off	200

7. If a device is set to Cycle, define the Water/Feeder On and Off times.

8. To adjust the target temperature during feeding (to increase ventilation):

- Define the To/From times.
- Define the Target Temperature Offset (to reduce the target).

NOTE To disable this feature set the offset to 0.

- Feed Cycle: Set to:
 - Daily: Same schedule for every day of the week.
 - 2 – 6 Days: Select a cycle that lasts the number of days chosen and then repeats itself. For example, 2 Days means that the cycle lasts two days and then repeats itself.
 - Week: Set a cycle for specific days.

NOTE When the cycle is set to 2-6 days or Week, you can skip specific days by pressing the +/- key

9. Go to Scale > Silo/Auger Layout.

SILO/AUGER LAYOUT		
Silo	Auger	Feed Type
1	Auger 1	Both
2	Auger 2	Both
3	Auger 3	Female
4	Auger 4	Female
5	Auger 5	Male
6	Auger 6	Male
7	Auger 7	Male
8	Auger 8	None

10. Map each silo to the silo auger number.

- To use this function, augers must be defined in Installation > Relay Layout. No mapping is possible unless augers have been defined.
- By default, the screen displays four silos and augers. If you define more than four relays as augers (or if you number even one auger relay as number 5 or higher), the screen displays eight silos.
- Even if all eight silos appear on the screen, the number of silos you can map equals the number of auger relays defined.
- Define the parameters:
 - Silo: Read only number.
 - Auger: This defines which auger is mapped to which silo. Define this as None (disabling the auger line) or Auger. Platinum Pro/Rotem Pro numbers the auger but you can manually edit the number. To edit, press the required number and then Enter.
 - Feed Type: If the silo contains feed designated for males or females, define that feed type in this parameter. Alternatively, define the feed type as Both (default) or None.

11. In Management > Feed Inventory, enter the quantity of feed in each silo. Note that if the silos are equipped with load cells, this table is filled automatically.

FEED INVENTORY					
No.	Date	Silo			
		1	2	3	4
1	2-Jan-08	7800	0	0	0
2	5-Jan-08	0	9000	15000	10000
3	13-Jan-08	8000	0	0	0
4	- -	0	0	0	0
5	- -	0	0	0	0
6	- -	0	0	0	0
7	- -	0	0	0	0
8	- -	0	0	0	0
Total Feed:		1580	9000	15000	10000
ACTIVE		0	√	0	√
		√		√	

12. Go to Device > Feed Scale Program.

NOTE This screen is wide and requires scrolling to view all parameters.

MIXING AND FILLING											
No	Start	Type	Silo				Inter Hopper Auger	Line Hopper Valves			
	Time		1	2	3	4		F	F	F	M
			M	F	M	N		1	2	3	17
1	5:00	None	0	0	0	0	1	0	0	0	9
2	10:00	Female	50	50	0	0	1	50	50	50	0
3	7:00	Male	50	0	50	0	2	0	0	0	50
4	12:00	Male	34	33	33	0	1	50	50	50	0
5	0:00	Female	0	0	0	0	2	0	0	0	0
6	0:00	None	0	0	0	0	1	0	0	0	0

NOTE This screen's appearance depends on the relay layout and silo/auger layout.

13. Define the feed mixture and distribution parameters.

- Number: You can define up to 20 feeding times per day.
- Type: Designate this feeding time as one of the following:
 - Female or Male. When defined as Female or Male, only those augers whose feed type matches this definition will add feed to the mixture. For example, if Number 1 is defined as Male, any auger defined as Female will not add feed at this time. However, an auger defined as Both will add feed. (Augsers are defined in Scale > Silo/Auger Layout> Feed Type)
 - None: This option disables a feeding time, while saving the feeding time's definitions. When defined as None, you cannot edit that line's parameters.
 - Erase: This option erases any parameter definitions for that number.
- Silo Augers (%): Under each auger, enter the percentage of feed that each silo provides. The default auger automatically adjusts its percentage as you define each auger's percentage.
 - In a line designated as Male or Female, you can only change the percentages of those augers matching the definition (or an auger defined as Both).
 - For example: If the line is defined as male, only augers defined as Male or Both can add feed. The cursor will automatically skip over any auger not matching the line definition.
 - Augers defined as None do not add feed.
- Inter. Hopper Auger: This parameter is read-only. If one auger is defined is defined, 1 appears. If two augers are defined, either one or two can appear.
 - If there is one auger line, this line can feed males or females (up to 24 valves).
 - Valves 1 – 16 are female,
 - Valves 17 – 24 are male (see Figure 15)
 - If there are two auger lines:
 - The Intermediate Hopper Auger 1 is mapped to the female line hoppers.
 - The Intermediate Hopper Auger 2 is mapped to the male line hoppers.
- Valves: Define the amount of feed that each feeding station receives.
 - Version 6.21: Range 0 – 22025 Lbs./0 –9999 Kg
 - Version 6.22: Range 0 – 22025.8 Lbs./0 –9999.9 Kg.

14. If required, set the help options.

12.9.3 FEED SCALE PROGRAM HELP | SET DEFINITIONS

SYSTEM PARAMETERS	
ADVANCED FEEDING SETTINGS	
Maximum Portion Size	55
Maximum Auger Time (min)	10
Not Empty Time	60
Stop Band Weight	2.2
Optimizer	Default
Valve Close Time (sec)	7
Feed Tare (A/D count)	0
Female Line of Hoppers	
Auger Feed Rate (weight/min)	66
Time to 1st Hopper	120
Time to Last Hopper	240

- Define:

ADVANCED FEEDING SETTINGS

- **Maximum Portion Weight:** Enter the feed scale container size.
- **Maximum Auger Time [minutes]:** This parameter sets an alarm for the auger running time. Enter the number of minutes that the auger can run, after which an alarm appears on the Main Screen.
- **Not Empty Time:** This parameter (in minutes) sets an alarm for the feed scale container. The container should distribute all of its feed to the feed lines. If feed remains in the container, it could mean that there is a problem (for example, the valve doesn't open). Set the amount of time that feed can remain in the container, after which an alarm appears on the Main Screen.
- **Stop Band Weight:** This parameter (kilos or pounds) defines the band at which augers cease to distribute feed. When the amount of feed distributed approaches the maximum portion weight by this amount, Platinum Pro/Rotem Pro ceases the distribution.
- **Optimizer:** This parameter sets the unit's sensitivity to signal noise (caused by a variety of factors). Sensitivity plays a role as the controller stabilizes itself. Greater amounts of noise require faster optimization. To view an indication of the controller's stability, go to *Scale Menu > Test* (refer to page 76) and perform a test. If the number remains stable, slower optimization is indicated. There are three settings: Default, Slower, Faster.

NOTE Munters recommends leaving this parameter at the default level.

- **Valve Close Time [seconds]:** Set the delay in time, if any, that the valve emptying the feed scale container closes.
- **Feed Tare [A/D count]:** This specification is used for certain tests performed by a certified technician.

NOTE Munters recommends leaving this parameter unedited.

Female/Male Line of Hoppers

- **Auger Feed Rate (weight/min):** Define the amount of feed to be sent to the birds over a defined amount of time.

NOTE If you define one relay only as the Inter. Hopper Auger, enter the same rate in both the Female and Male Line of Hoppers.

- **Time to 1st Hopper:** Amount of time required for feed to travel from the intermediate hopper to the first hopper valve.
- **Time to Last Hopper:** Amount of time required for feed to travel from the intermediate hopper to the last hopper valve. Note that the last valve is the last valve actually defined. For example if six valves are defined, enter the amount of time required for the feed to reach valve number six.
- **Line Hopper Feed Gap:** The amount of time required for feed to travel the distance between each hopper.

12.10 Egg Room History

- Go to *History > Egg Room* to view a daily history of the egg room temperature and humidity. Press the right/left arrow keys to switch between views.

EGG ROOM			
Day	TEMPERATURE		
	Minimum	Average	Maximum
1	76	79	80

EGG ROOM			
Day	HUMIDITY		
	Minimum	Average	Maximum
1	62	65	69

13 Appendix C: Natural Ventilation

Version 6.14 supports Natural Ventilation. The following section details the setup and theory.

- Natural Ventilation Setup
- Theory of Operation

13.1 Natural Ventilation Setup

1. Go to Installation > Setup.

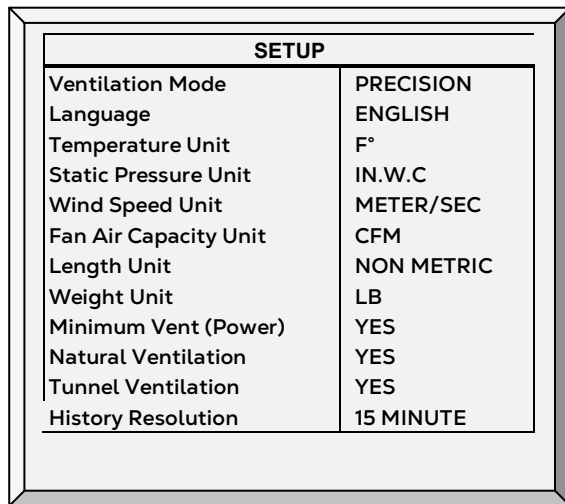

SETUP	
Ventilation Mode	PRECISION
Language	ENGLISH
Temperature Unit	F°
Static Pressure Unit	IN.W.C
Wind Speed Unit	METER/SEC
Fan Air Capacity Unit	CFM
Length Unit	NON METRIC
Weight Unit	LB
Minimum Vent (Power)	YES
Natural Ventilation	YES
Tunnel Ventilation	YES
History Resolution	15 MINUTE

2. Set Natural Ventilation to YES.

3. Go to Installation > Relay.

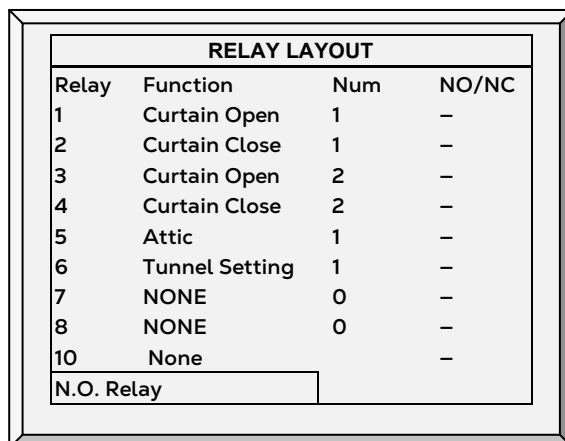

RELAY LAYOUT			
Relay	Function	Num	NO/NC
1	Curtain Open	1	-
2	Curtain Close	1	-
3	Curtain Open	2	-
4	Curtain Close	2	-
5	Attic	1	-
6	Tunnel Setting	1	-
7	NONE	0	-
8	NONE	0	-
10	None		-
N.O. Relay			

4. Define relays as Curtain Open and Curtain Close (up to four each) (for details refer to - Layout, page 102).

5. Go to Device > Temperature Device Settings (option).

TEMPERATURE DEFINITION	
Function	Temp. Sensor
	1 2 3 4 5 6 7 8 9
FULL HOUSE	√√*
TUNNEL SETTING
ATTIC	. . . √ . . .
OUTSIDE √ . .
Curtain 1	. . √ . √ . .
Curtain 2 √ . .

6. Assign specific temperature sensor(s) to each curtain (for details refer to – Definition, page 109).

NOTE If you do not assign a sensor to a curtain, the house temperature determines the curtain's natural ventilation functionality.

7. Go to Install > Vent/Curtain Setup.

VENT/CURTAIN SETUP				
Curtain	Pot	Open (sec)	Close (sec)	
~ Tunnel 1	POT 1	60	60	
Tunnel 2	POT 1	60	60	
~ Curtain 1	POT 2	60	60	
Curtain 2	NONE	60	60	
Attic 1	NONE	60	60	

8. Define the curtains opening and closing times (for details refer to Using Time to Calibrate).

9. Go to Install > Vent/Curtain Setup > Help (option).

SYSTEM PARAMETERS	
CURTAIN CALIBRATION	
From Time	0:00
To Time	0:00
Number of Steps	0
Power Up Vents Calibration	NO
Proximity to Edge %	10
Close Below This Temp. (out)	0.0

10. Set the parameters as required (refer to Vent/Curtain Help | Set Definitions, page 108 for details).

11. Go to Device > Temp & Timer Settings.

TEMP & TIMER SETTINGS				
Device	ON	OFF	MNT	Option
Tunnel Fan 4	88.0	85.0	--✓	----
Tunnel Fan 3	88.0	85.0	--✓	----
Tunnel Fan 2	88.0	85.0	-✓-	----
Tunnel Fan 1	88.0	85.0	--✓	----
NATURAL SETTING	88.0	85.0		
Curtain 2	83.0	82.0	✓✓-	----
Curtain 1	81.0	82.0	-✓-	----
TUNNEL SETTING	88.0	85.0		
Heat 2	75.0	76.0		----
Heat 1	75.0	76.0		----

12. Define:

- The temperature at which natural ventilation begins (Natural Setting).

NOTE This parameter determines when Platinum Pro/Rotem Pro enters and exits Natural Ventilation. The temperature sensors and curtain on/off parameters determine how the curtains operate in Natural Ventilation.

- Each curtain's operational temperature (Curtain On/Off)
- In which ventilation mode the curtains operation (Minimum Ventilation (M), Natural (N), Tunnel (T)).
- Refer to · & Timer Setting, page 33 for details.

CAUTION If all MNT functions are disabled on a curtain, the curtain nevertheless functions in all three modes. At least one mode must be enabled to disable other modes.

13. Go to Device > Temp & Timer Settings > Help.

VENT/CURTAIN SETTINGS	
Minimum Tunnel Fans On	4
Tunnel Exit Delay (minutes)	5
Non Brood Area Diff. From Heat	-
	99.0
RADIANT HEATERS	
Radiant Heater High Diff	1.0
Radiant Ignition Time (sec)	30
CURTAINS	
Minimum Position %	20
Delay Between Steps (seconds)	300
Step Size %	15

14. Set the curtain parameters as required (refer to Vent/Curtain Help | Set Definitions, page 108 for details):

- Minimum Position %: This is the smallest curtain opening in Natural Ventilation Mode. Range: 0 – 100%. Default: 30%.
- Delay Between Steps (seconds): Delay in time between each curtain movement. Range: 0 – 999. Default: 300.
- Step Size %. The change in the curtain's position at each step. Note that when closing, the change will never place the curtain below the minimum position.

13.2 Theory of Operation

Natural Ventilation enables supplying the house's air requirements using the wind. While in this mode, up to four curtains open and close based on temperature only (meaning, other factors such as humidity, wind direction or speed don't have any effect). In addition, ventilation via static pressure is disabled.

13.2.1 TRANSITION TO OR FROM NATURAL VENTILATION

Platinum Pro/Rotem Pro enters Natural Ventilation when the temperature is above the Natural Setting On temperature (see Step 12 above). At that point, the actual curtain operation (how far they open, how many steps, etc.) is controlled by the temperature sensors (see Step 5 above).

- When Platinum Pro/Rotem Pro goes from Minimum or Tunnel Ventilation to Natural:
 - Any fan not designated as working in Natural (in Temp & Timer Settings) will stop operating. In the screen shown in Step 11 Tunnel Fans 1, 3, and 4 cease to operate.
 - Vent or tunnel curtains close to 0%.
 - Natural curtains:
 - When going from Minimum Ventilation to Natural, curtains open to their minimum position (20% in Step 13).
 - When going from Tunnel Ventilation to Natural, curtains open to 100% and then re-adjust themselves according to the curtain steps and temperature.
 - If a curtain that is currently open is designated to work in Natural and either Minimum or Tunnel mode, the curtain remains in place.

Platinum Pro/Rotem Pro exits Natural Ventilation when the temperature is below the Natural Setting Off temperature (see Step 12 above).

- When Platinum Pro/Rotem Pro goes from Natural Ventilation to Minimum or Tunnel Ventilation to
 - Any fan designated as working only in Natural (in Temp & Timer Settings) will stop operating. In the screen shown in Step 11 Tunnel Fan 2 shuts down.
 - Vents or tunnel curtains open to their minimum positions
 - Natural curtains:
 - Any curtain designated to work only in Natural Ventilation mode closes. In the screen shown in Step 11 Curtain 1 closes.
 - If an open curtain is designated to work in Natural and either Minimum or Tunnel mode, the curtain remains in place. However, if the temperature is below the Natural Setting Off temperature, curtains move to their minimum position.
 - Control mechanisms such as static pressure only begin to function when the transition is completed.

13.2.2 CURTAIN MOVEMENT

When in Natural Ventilation mode

- If the temperature is above a curtain's ON temperature, the curtain opens after the delay time according to the amount specified in the step size (Step 13 above). After each step, the curtain waits the delay time before any further opening.
- If the temperature is below a curtain's OFF temperature, the curtain closes after the delay time according to the amount specified in the step size (Step 13 above). However, the curtain will not go below the minimum opening position.
- When the temperature is between the On and Off temperatures, the curtain remains in place.

13.2.3 TOGGLE SWITCHES

All the information above assumes that the curtains' relay switches are set to Automatic. If the user moves a curtain's open relay toggle switch to ON:

- If the curtain was opening at the time, Platinum Pro/Rotem Pro will use the curtain's current position for all calculations when the toggle switch is reset to Automatic. For example, if the curtain is 75% open when the switch is reset to Automatic, Platinum Pro/Rotem Pro uses that position as the curtains starting point.
- If the curtain was closing at the time, the curtain reverses its movement and begin to open. However, when the toggle switch is reset to Automatic, the curtain returns to its previous position. For example if the curtain had gone down to 45% open when the toggle switch was set to On, it will return to 45% when the switch is reset to Automatic.

14 Appendix D: Device Setup Summary

The following section summarizes how to setup up different devices in Platinum Pro/Rotem Pro.

- Stir Fans
- Attic Ventilation
- Heaters Control

14.1 Stir Fans

Stir fans mix the air, to maintain a uniform temperature throughout the house. It does this by mixing (recycling) warmer air with the rest of the house (back down across the floor).

1. In *Installation > Relay Layout* and/or *Installation > Analog Output*, define relays as stir fans.
2. In *Device > Temp & Timer Settings*, define the parameters as required.
3. In *Device > Temp & Timer Settings > Help*, define the Stir Fan parameters as required.

SYSTEM PARAMETERS	
STIR FANS	
Cycle Delay Time (sec)	0
Operate During Cycle	OFF
ON Temp Output (MV)	STOP
Variable Stir Output %	100

- Cycle Delay Time (sec): Stir fans begin to operate during the Minimum Ventilation cycles after this delay.
 - Operate During Cycle: Enable or disable stir fan operation during Minimum Ventilation.
 - On Temp Output: This parameter enables keeping the variable speed stir fans off when the temperature rises to the on temperature.
 - Variable Stir Output: Set the operating speed (in voltage percentage) of variable speed stir fans.
4. In *Installation > Temperature Definition*, map a temperature sensor to a stir fan.

14.2 Attic Ventilation

Attic fans maximize the amount of fresh air in cold weather by utilizing warm air found near the ceiling. Air entering via the attic inlets tends to become warmer and drier than the outside air.

NOTE Munters recommends operating the attic vents at static pressures lower than the vent inlets.

1. In *Installation > Relay Layout*, define relays as attic open and attic close.
2. In *Installation > Temperature Definition*, map a temperature sensor to the attic.
3. In *Installation > Vent/Curtain Setup*, define the parameters.
4. In *Device > Temp & Timer Settings*, define the parameters as required.
5. In *Device > Temp & Timer Settings > Help*, define the Stir Fan parameters as required.

SYSTEM PARAMETERS	
ATTIC	
Minimum Attic Temperature	35.0
Maximum Attic Temperature	100.0
From Time	0:00
To Time	0:00
Stop Attic When This Fan ON	None
Attic Ventilation By	AVG

- Minimum/Maximum Attic Temperature: Attic fans run between these temperatures.
- From/To Time: Attic fans run between these times.
- Stop Attic When this Fan On: Attic fan ceases to operate when the selected fan runs. To disable select None.
- Attic Ventilation By: Define which temperature reading is used to determine when the attic fans run, Average Temperature or Attic Temperature.

14.3 Heaters Control

Regular and Radiant Heaters Control is based on the following settings:

1. In *Installation > Relays* select the heating devices.
2. In *Installation > Temperature Definitions* map a temperature sensor to each heating device.

NOTE If a heater shares the same temperature sensor with a brood sensor, Platinum Pro/Rotem Pro assigns the heater automatically to Brood Area and operates accordingly.

3. At *Control > Temp. & Timer Settings* define the heating parameters as required.
 - On Temp specifies the Heater On temperature (always below or equal to set temperature)
 - Off Temp specifies the Heater Off temperature (could be higher than the Set temperature.)

4. In *Device > Temp & Timer Settings > Help* define the Non-Brood Area Difference Below Heat and Radiant Heater Specs as required.

SYSTEM PARAMETERS	
RADIANT HEATERS	
Radiant Heater High Diff	1.0
Radiant Ignition Time	30

Notes:

- When regular heater is activated, the low-pressure alarm is disabled since heaters produce positive static pressure.
- Heater Off Temperature must be at least 0.5° F higher than the Heater On Temperature.
- Heater On Temperature must be equal or less than the Set Temperature.

15 Appendix E: Previous Version Functions

This chapter provides information for people employing versions 6.21 and below.

- Scale Menu, Version 6.21 and Below
- Test, Version 6.18 and Below
- Vent & Curtain Levels Help | Set Definitions Version 6.18 or Below

15.1 Scale Menu, Version 6.21 and Below

- Setting up a Curve – Summary
- Scale Layout
- General Settings
- Bird Scale Setting
- Gender Based Weighing, Version 6.21
- Bird Curve/Bird Weight
- History

15.1.1 SETTING UP A CURVE – SUMMARY

NOTE A Scale Card or RSU must be installed.

In Versions 6.18 or below, setting up a bird curve means defining the following items in the Scale Menu:

- [Scale Card](#): Define at least one scale.
- [General Settings](#): Define the curve type (broiler, breeder, turkey)
- [Bird Scale](#): Define the curve parameters.
- [Bird Curve](#): Define the curve data points (day and weight).

In Versions 6.19, setting up a bird curve means defining the following items in the Scale Menu:

- [Scale Card](#): Define at least one scale.
- [Bird Scale](#): Define the curve type (Auto, Custom, or Cobb/Robb)
- [Bird Weight](#): Define the curve data points (day and weight; Custom or Cobb/Robb curves only).

In Versions 6.21 or above there is an additional option [enabling gender-based weighing for birds](#).

15.1.2 SCALE LAYOUT

Use Scale Layout to define the scales or silos connected to the controller.

- Scale Layout, Version 6.17 and Below
- Scale Layout, Version 6.18

15.1.2.1 Scale Layout, Version 6.17 and Below

NOTE Versions 6.17 and below do not support a scale card. An RSU-2 unit must be connected to the controller for these screens to appear.

SCALE LAYOUT		
Chan.	Function	No.
RSU 1		
1	Silo	1
2	Silo	2

Figure 16: Pig Mode Scale Layout

SCALE LAYOUT		
Chan.	Function	No.
RSU 1		
1	Scale	1
2	Scale	2
3	Silo	1
4	Silo	2

Figure 17: Poultry Mode Scale Layout

Define the weighing device attached to each channel of the scale option card.

15.1.2.2 Scale Layout, Version 6.18 and Above

NOTE A scale card must be installed in the controller or an RSU-2 unit must be connected to the controller for these screens to appear.

Version 6.18 supports the RSU-2 and two types of scale cards:

- Two channel scale cards: Supports bird scales only.
- Six channel scale cards: Supports bird, silo, and feed scales (Breeder Mode does not support feed scales). The controller can support up to ten weighing channels.
- Refer to the installation manual regarding Munters' recommendations regarding these options.

SCALE LAYOUT		
Scale Card		
Chan.	Function	No.
1	Silo 1	1
2	Silo 2	2
RSU 1		
1	Silo 3	3
2	Silo 4	4

Figure 18: Two Channel Layout

SCALE LAYOUT		
Ch.	Function	No.
Scale Card		
1	Scale	1
2	Scale	2
3	Silo	1
4	Silo	2
5	Feed Scales	1
6	Scale	3
RSU 1		
1	Silo 3	3
2	Scale 3	3

Figure 19: Six Channel Layout

15.1.3 GENERAL SETTINGS

- General Settings Main Settings
- General Settings Help | Set Definitions

15.1.3.1 General Settings Main Settings

This menu sets general weighing parameters.

NOTE This function does not appear in Version 6.19 and above.

NOTE Only Broiler/Layers Mode supports this function.

GENERAL SETTINGS	
Bird Scale Mode ▶	SEXED
Uniformity Range (5-30%)▶	10
Curve Selector (for mixed)▶	BROILER
Weigh During Feed Days	NO

- **Bird Scale Mode:** Select the weighing method. The mode chosen determines the curve employed in Bird Scale Setting, Version 6.18 and Below.
 - **Sexed:** Considers all birds to be the same sex, or 'unisex' as in mixed broilers. It computes its own reference weight or acceptable range from the weighed birds.
 - **Mixed:** Considers the flock to be mixed males and females, with the goal of identifying each bird weight as male or female, which is, classifying it according to a pre-programmed pair of expected weight curves.
 - **Male/Female:** Select one of these options when the birds are a single gender.
- **Uniformity Range (5-30%):** Controller classifies bird weights within this percentage of the average as uniform. Default is 10%.
- **Curve Selector (for mixed):** There are three standard pairs of pre-programmed weight curves. If you use the mixed weighing method, edit the curves to match your expected growth profile (Broiler, Turkey, or Breeder).
- **Weigh During Feed Days:** Allow weight data to be recorded on feed days. When set to NO, this data is discarded. Default: No

15.1.3.2 General Settings Help | Set Definitions

② While viewing the **General Settings** menu: Press **HELP**, select **SET** and press **ENTER**.

BIRD CURVE	
Factory Default Curve	No

- **Factory Default Curve:** Select YES to return bird curves to the factory default settings

15.1.4 BIRD SCALE SETTING

➡ Define at least one scale, silo, or feed scale in Scale Layout.

NOTE This section describes the Bird Scale Settings for Broiler mode. Refer to Breeder and Layer Mode appendices to view the function for those modes.

- Bird Scale Setting, Version 6.18 and Below
- Bird Scale Setting, Version 6.19

15.1.4.1 Bird Scale Setting, Version 6.18 and Below

There are two different weighing options available; the option can be selected in the previous section.

BIRD SCALE SETTING - SEXED	
Start Time	18:00
End Time	19:00
Range - (0 - 100%)	30
Reference Weight 1	0.13
Reference Weight 2	0.11

BIRD SCALE SETTING - MIXED	
Start Time	18:00
End Time	19:00
Range - (0 - 100%)	20

- Start Time: Set the hour you would like the scale to begin weighing
 - End Time: Set the hour you would like the scale to stop weighing
 - Range - (0-100%): Band above and below reference weight
 - Reference Weight 1: Starting out weight for scale 1
 - Reference Weight 2: Starting out weight for scale 2
- Start Time: Set the hour you would like the scale to begin weighing
 - End Time: Set the hour you would like the scale to stop weighing
 - Range - (0-100%): Band above and below reference weight

NOTE Version 6.18 supports four reference weights.

15.1.4.2 Bird Scale Setting, Version 6.19

- Bird Scale Setting Screen
- Bird Scale Setting | Set Definitions

15.1.4.2.1 Bird Scale Setting Screen

In this screen, select the algorithm used to calculate the bird curve that appears in Bird Weight, Version 6.19. There are three options:

BIRD SCALE SETTING	
Weighing Method	Auto

Auto
Custom
Cobb 500
Cobb 700
Ross 308
Ross 708

- **Auto:** Set the first target weight. The controller then automatically calculates each day's reference weight.
- **Custom:** The controller provides a weight vs growth day curve, which the user can edit as required.
- **Factory Default Curve:** The controller loads an industry standard bird curve. This curve cannot be edited.

15.1.4.2.2 Bird Scale Setting | Set Definitions

- ② While viewing the Bird Scale Setting menu: Press **HELP**, select **SET**, and press **ENTER**.

BIRD SCALE SETTING	
Upper Range [%]	25
Lower Range [%]	25

- The upper/lower range parameters define the range of weights that are recorded. The weights of birds that exceed differ from the bird curve by these amounts are discarded.

15.1.5 GENDER BASED WEIGHING, VERSION 6.21

NOTE Version 6.21 and above supports this version.

- Enabling Gender Based Weighing
- Measuring Gender-Defined Bird Weights, Auto Curve
- Measuring Gender-Defined Bird Weights, Customized/Industrial Standard Curve

15.1.5.1 Enabling Gender Based Weighing

Gender Based Weighing enables setting up separate reference weight curves for male and female birds.

To enable gender-based bird curves:

1. Go to Scale > Scale Layout > Help.

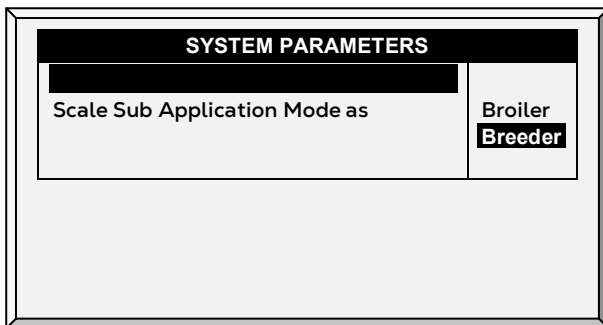

2. Select **Breeder**.
 - Breeder includes two options for setting up the curve: a controller-generated curve and an industrial standard curve.
 - Measuring Gender-Defined Bird Weights, Auto Curve
 - Measuring Gender-Defined Bird Weights, Customized/Industrial Standard Curve

The **Broiler** option enables a single weight curve. Continue defining the curve as detailed in Bird Scale Setting, Version 6.19 and Bird Weight, Version 6.19.

15.1.5.2 Measuring Gender-Defined Bird Weights, Auto Curve

1. Go to Scale > Bird Scale Setting.

BIRD SCALE SETTING	
Weighing Method	Auto
Scale 1	Female
Scale 2	Female
Scale 3	Male
Scale 4	Male

2. In Weighing Method, select Auto.

3. Go to Scale > Bird Scale Setting > Help. Define the parameters (option).

BIRD SCALE SETTING	
Female	
Upper Range [%]	10
Lower Range [%]	15
Male	
Upper Range [%]	15
Lower Range [%]	10

- Male/Female: The upper/lower range parameters defines the range of weights that are recorded. The weights of birds that exceed differ from the bird curve by these amounts are discarded. Note that the default range of the female and male bird are reversed.

4. Go to Scale > Bird Weight.

BIRD WEIGHT	
Current Female Weight	0.09
Current Male Weight	0.09

5. The Bird Weight screen displays the target weight for the current growth day for each gender. Edit the weight as required.

15.1.5.3 Measuring Gender-Defined Bird Weights, Customized/Industrial Standard Curve

1. Go to Scale > Bird Scale Setting

BIRD SCALE SETTING	
Weighing Method	Auto
Scale 1	Female
Scale 2	Female
Scale 3	Male
Scale 4	Male

2. In Weighing Method, select Curve.

3. Go to Scale > Bird Scale Setting > Help. Define the parameters (option).

BIRD SCALE SETTING	
Female	
Upper Range [%]	10
Lower Range [%]	15
Male	
Upper Range [%]	15
Lower Range [%]	10

- Male/Female: The upper/lower range parameters defines the range of weights that are recorded. The weights of birds that exceed differ from the bird curve by these amounts are discarded. Note that the default range of the female and male bird are reversed.

4. Go to Scale > Bird Weight > Help.

BIRD WEIGHT	
FEMALE	
Curve Offset	0.00
Select Curve	Cobb500SDOt
MALE	
Curve Offset	0.00
Select Curve	CobbMV

5. Define the parameters:

- Curve Offset: Enter the factor used to adjust the weight curve. This amount is added to the curve. Range: -4.40 to +4.41 Kg/Lb.
- Select Curve:
 - Custom: the Bird Weight screen displays a generic curve for each day's target weight. You can edit the weight as required.
 - Factory default curve: The Bird Weight screen displays each day's target weight using an industry standard. These data points are read-only. Note that there are different curves for female or male birds.

6. Go to Scale > Bird Weight.

BIRD WEIGHT		
Day	Female	Male
0	0.09	0.10
7	0.33	0.31
14	0.63	0.66
21	0.90	1.06
28	1.21	1.46

- The Bird Weight screen displays the target weight for the current growth day for each gender.
 - If you selected Custom in Help, edit the fields as required.
 - If you selected an industrial standard, all fields are read-only.
- Note: If you select Custom, the controller saves all changes that you make to the fields. Meaning that after configuring a customized curve, you can go to

the Help, select an industrial curve, and then go back and select Custom. The curve that you defined will reappear.

15.1.6 BIRD CURVE/BIRD WEIGHT

This section describes the Bird Scale Settings for Broiler mode. Refer to Breeder and Layer Mode appendices to view the function for those modes.

- Bird Curve, Version 6.18 and Below
- Bird Weight, Version 6.19

15.1.6.1 Bird Curve, Version 6.18 and Below

This screen displays the expected bird weight according to growth day for broilers, turkeys, or breeders, as previously set in Bird Scale Setting, Version 6.18 and Below.

NOTE Only Broilers/ Layers Mode supports this function.

BIRD CURVE		
Day	Female Weight	Male Weight
1	0.11	0.13
7	0.31	0.35
14	0.66	0.70
21	1.26	1.54
28	2.07	2.73
35	3.15	4.27
42	4.45	6.15
49	5.95	8.22
Now	1.87	2.44

- Edit the growth days and weights for the bird curves to fit your requirements.

15.1.6.2 Bird Curve Help | Set Definitions

② While viewing the Bird Curve menu: Press **HELP**, select **SET** and press **ENTER**.

BIRD CURVE	
Bird Curve Offset	0.2

- **Bird Curve Offset:** Enter the factor used to adjust the weight curve. This amount is added to the Reference weight field. 0.0 – 10.0 Kg/Lb.

15.1.6.3 Bird Weight, Version 6.19

This screen displays the expected bird weight according to growth day. Which screen is displayed is dependent on the curve selected in Bird Scale Setting, Version 6.19 (page 148).

- Bird Weight Screens
- Bird Weight Help | Set Definitions

15.1.6.3.1 Bird Weight Screens

- Auto Method

BIRD WEIGHT AUTO METHOD	
Current Weight	1.00

- If you selected Auto in Bird Scale Setting, the Bird Weight screen displays the target weight for the current growth day. You can edit the weight as required.

- Custom Weight

CUSTOM CURVE	
Day	Weight
0	0.00
1	0.00
2	0.00
3	0.00
4	0.00
5	0.00

- If you selected Custom in Bird Scale Setting: Edit the weights as required.

- Factory Default Curve

WEIGHT CURVE	
Day	Weight
0	0.09
1	0.13
2	0.16
3	0.20
4	0.24
5	0.30

- If you selected a Cobb or Robb Curve in Bird Scale Setting, the Bird Weight screen displays each day's target weight using an industry standard. These data points are read-only.

15.1.6.3.2 Bird Weight Help | Set Definitions

- ① While viewing the Bird Weight menu: Press **HELP**, select **SET** and press **ENTER**.

NOTE Auto method does not feature a help screen.

BIRD WEIGHT	
Curve Offset	0.0
	0

- **Curve Offset:** Enter the factor used to adjust the curve. This amount is added to the "Now" field. Range: -2.000 – 2.000 Kg / -4.40 - 4.41 Lb.

15.1.7 HISTORY

The scale history shows bird weight statistics. You can review daily data for each scale, or separately.

- History, Version 6.18 and Below
- History, Version 6.19

15.1.7.1 History, Version 6.18 and Below

- In Version 6.17 and below, the unit records the data of up to two-bird scales; if you have more than one scale-1, data is combined.
- In Version 6.18, the controller records up to four scales.

NOTE Only Broiler/Layers Mode supports this function

HISTORY					
Day	Avg.	NO.	S.D.	Unif.	C.V
17	0.000	0	0.000	0	0
18	0.000	0	0.000	0	0
19	0.000	0	0.000	0	0
20	0.000	0	0.000	0	0
21	0.000	0	0.000	0	0
22	0.000	0	0.000	0	0
23	0.000	0	0.000	0	0
24	0.159	1	0.000	100	0
25	0.000	0	0.000	0	0
26	0.000	0	0.000	0	0

Figure 20: Version 6.17 or below

HISTORY									
Day	Avg.	Scale1	Scale2	Scale3	Scale4	NO.	S.D.	Unif.	C.V
17	0.000	0.000	0.000	0.000	0.000	0	0.000	0	0
18	0.000	0.000	0.000	0.000	0.000	0	0.000	0	0
19	0.000	0.000	0.000	0.000	0.000	0	0.000	0	0
20	0.000	0.000	0.000	0.000	0.000	0	0.000	0	0
21	0.000	0.000	0.000	0.000	0.000	0	0.000	0	0
22	0.000	0.000	0.000	0.000	0.000	0	0.000	0	0
23	0.000	0.000	0.000	0.000	0.000	0	0.000	0	0
24	0.159	0.000	0.000	0.000	0.000	1	0.000	100	0
25	0.000	0.000	0.000	0.000	0.000	0	0.000	0	0
26	0.000	0.000	0.000	0.000	0.000	0	0.000	0	0

Figure 21: Version 6.18

- If you selected **SEXED** weighing, the history includes average data for the combined scales, and on the next screens separate data for each scale.
- If you select **MIXED** weighing, the history includes average data for all birds, and separate male and female data for Scale 1 and for Scale 2.
 - Use the arrow keys to scroll to the separated scale data, or up and down for data that is off screen.
 - The average and the number of weights are the usual definition. The Standard Deviation is the usual biased estimator (see a suitable textbook on statistical measurements). The Uniformity is the industry standard 10%

uniformity (number of birds per 100 within 10% of the average weight), and the Coefficient of Variation or C.V. is the normalized standard deviation (standard deviation divided by average times 100 %.)

15.1.7.2 History, Version 6.19

HISTORY									
Day	Avg.	D.Gain	Unif.	No.	Scale1	D.Gain	Unif.	No.	
1	0.00	0.00	0.00	0.00	0.00		0.00	0.00	
2	0.00	0.00	0.00	0.00	0.00		0.00	0.00	
3	0.00	0.00	0.00	0.00	0.00		0.00	0.00	

- The D. Gain shows difference between the current average weight and the previous day's average weight; the data comes from all the scales.
- No daily gain is shown for individual scales.

15.2 Test, Version 6.18 and Below

This section is a real-time table to show the statuses of all scales connected to the controller. Make sure that all statuses are O.K. If any of them show a different status, the scale is not installed properly. Unused positions can also show O.K.

- Test, Version 6.17 and Below
- Test, Version 6.18

15.2.1 TEST, VERSION 6.17 AND BELOW

1. In *Scale > Scale Layout* (refer to page Error! Bookmark not defined.), select the required scale types.
2. In *Scale > Test*, test the scales as required.

TEST				
	- 1 -	- 2 -	- 3 -	- 4 -
Type	Scale-1	Scale 2	Scale 3	Scale 4
A/D	2024	2010	1891	1893
Weight	0.222	35.768	0.000	0.000
Status	O.K.	O.K.	O.K.	O.K.

15.2.2 TEST, VERSION 6.18

1. In *Scale > Scale Layout* (refer to page 146), select the required scale types.
2. In *Scale > Test*, test the scales as required.

TEST			
Ch	A/D	Weight	Status
Silo 1	2024	0.222	O.K.
Silo 2	2010	0.240	O.K.
Feed Scale 1	2024	0.200	O.K.
Silo 3	2011	0.240	O.K.
Scale 1	2000	0.222	O.K.
Scale 2	2024	0.222	O.K.

15.3 Vent & Curtain Levels Help | Set Definitions Version 6.18 or Below

- ② While viewing the Vent & Curtain Levels menu: Press **HELP**, select **SET** and press **ENTER**.

SYSTEM PARAMETERS	
CURTAINS	
Stop Fans, Curt. Move (total %)	30
1st Day for 2nd Vent to Oper.	-2
1st Level for 2nd Vent to Oper	1
ATTIC	
Minimum Attic Temp. To Operate	75
Operate Until Level	10
Operate From Time	0:00
Operate To Time	0:00
Max Temperatur to Disable Attic	100.0

Curains

- **Stop Fans, Curtain Move (total %):** Commands controller to stop fans during curtain movements when total of all curtains is less than the total percent set in this parameter. For example, 3 curtains at 40% each total 120% for this parameter. Default: 30%
- **1st Day for 2nd Vent to Operate:** Set the day the second vent begins operating. Default: 1.

NOTE You can set negative days.

- **1st Level for 2nd Vent to Operate:** Set the level the second vent begins operating. Default: 1

Attic

- **Minimum Attic Temperature To Operate:** Set the minimum temperature to activate the attic operation.
- **Operate Until Level:** Set the maximum ventilation level for attic operation.
- **Operate From/To Time:** Set the time frame for attic operation.

NOTE If one of the above options is relevant, the Attic is enabled.

- **Maximum Temperature to Disable Attic:** Set the maximum attic temperature to stop using attic ventilation. This setting can prevent the heating effect in the growing space being too high resulting in overheating.

15.4 Breeder Nest Function, Version 6.18 and Below

Nests				
Num	Open Time	Duration	Close Time	Duration
1	0:00	0	0:00	0
2	0:00	0	0:00	0
3	0:00	0	0:00	0
4	0:00	0	0:00	0

1. In *Installation > Relay Layout* designate up to four relays (each) as Nest Open and Nest Close relays.

2. In *Device > Nest*, define the parameters:

- Open Time: The time each Nest lines' doors open.
- Duration: The amount of time required for the Nests to open.
- Close Time: The time each Nest lines' doors close.
- Duration: The amount of time required for the Nests to close.

15.5 Nest Function, Version 6.18 and Below

The Nest function enables opening and closing (up to) four Nest lines at specific times. Birds can then leave their Nests and return.

Nests				
Num	Open	Duration	Close	Duration
	Time		Time	
1	0:00	0	0:00	0
2	0:00	0	0:00	0
3	0:00	0	0:00	0
4	0:00	0	0:00	0

1. In *Installation > Relay Layout* designate up to four relays (each) as Nest Open and Nest Close relays.

2. In *Device > Nest*, define the parameters:

- Open Time: The time each Nest lines' doors open.
- Duration: The amount of time required for the Nests to open.
- Close Time: The time each Nest lines' doors close.
- Duration: The amount of time required for the Nests to close.

16 Warranty

Warranty and technical assistance

Munters products are designed and built to provide reliable and satisfactory performance but cannot be guaranteed free of faults; although they are reliable products they can develop unforeseeable defects and the user must take this into account and arrange adequate emergency or alarm systems if failure to operate could cause damage to the articles for which the Munters plant was required: if this is not done, the user is fully responsible for the damage which they could suffer.

Munters extends this limited warranty to the first purchaser and guarantees its products to be free from defects originating in manufacture or materials for one year from the date of delivery, provided that suitable transport, storage, installation and maintenance terms are complied with. The warranty does not apply if the products have been repaired without express authorisation from Munters, or repaired in such a way that, in Munters' judgement, their performance and reliability have been impaired, or incorrectly installed, or subjected to improper use. The user accepts total responsibility for incorrect use of the products.

The warranty on products from outside suppliers fitted to Platinum Pro/Rotem Pro, (for example sensors, analog inputs, cables, etc.) is limited to the conditions stated by the supplier: all claims must be made in writing within eight days of the discovery of the defect and within 12 months of the delivery of the defective product. Munters has thirty days from the date of receipt in which to take action, and has the right to examine the product at the customer's premises or at its own plant (carriage cost to be borne by the customer).

Munters at its sole discretion has the option of replacing or repairing, free of charge, products which it considers defective, and will arrange for their despatch back to the customer carriage paid. In the case of faulty parts of small commercial value which are widely available (such as bolts, etc.) for urgent despatch, where the cost of carriage would exceed the value of the parts, Munters may authorise the customer exclusively to purchase the replacement parts locally; Munters will reimburse the value of the product at its cost price.

Munters will not be liable for costs incurred in demounting the defective part, or the time required to travel to site and the associated travel costs. No agent, employee or dealer is authorised to give any further guarantees or to accept any other liability on Munters' behalf in connection with other Munters products, except in writing with the signature of one of the Company's Managers.

WARNING! *In the interests of improving the quality of its products and services, Munters reserves the right at any time and without prior notice to alter the specifications in this manual.*

The liability of the manufacturer Munters ceases in the event of:

- dismantling the safety devices;
- use of unauthorised materials;

- inadequate maintenance;
- use of non-original spare parts and accessories.

Barring specific contractual terms, the following are directly at the user's expense:

- preparing installation sites;
- providing an electricity supply (including the protective equipotential bonding (PE) conductor, in accordance with CEI EN 60204-1, paragraph 8.2), for correctly connecting the equipment to the mains electricity supply;
- providing ancillary services appropriate to the requirements of the plant on the basis of the information supplied with regard to installation;
- tools and consumables required for fitting and installation;
- lubricants necessary for commissioning and maintenance.

It is mandatory to purchase and use only original spare parts or those recommended by the manufacturer.

Dismantling and assembly must be performed by qualified technicians and according to the manufacturer's instructions.

The use of non-original spare parts or incorrect assembly exonerates the manufacturer from all liability.

Requests for technical assistance and spare parts can be made directly to the nearest [Munters office](#).

