

CommBox Plus

Installation and User Manual



CommBox Plus

Internet Access

P/N: 117870

 Munters

CommBox Plus

Installation and User Manual

Document Revision: 1.2, 08/2025

Software Ver: 4.7.4.21

This manual for use and maintenance is an integral part of the apparatus together with the attached technical documentation.

This document is destined for the user of the apparatus: it may not be reproduced in whole or in part, committed to computer memory as a file or delivered to third parties without the prior authorization of the assembler of the system.

Munters reserves the right to effect modifications to the apparatus in accordance with technical and legal developments.

Index

<i>chapter</i>		<i>page</i>
1	INTRODUCTION.....	6
1.1	Disclaimer	6
1.2	Introduction	6
1.3	Notes	6
2	INTRODUCTION TO THE COMMBOX PLUS	7
2.1	Ordering	7
2.2	Junction Box	8
2.3	What Comes in the Package.....	8
2.4	Block Diagrams.....	10
3	HARDWARE INSTALLATION.....	11
3.1	Precautions	11
3.2	CommBox Plus Ports.....	12
3.3	Mounting the CommBox Plus.....	13
3.4	Connecting the CommBox Plus to the Internet	13
•	Connect the CommBox Plus to your Internet connection/modem.	13
3.5	SIM Card Connectivity.....	14
3.6	Connecting the CommBox Plus to a Peripheral Device.....	15
3.7	Connecting the CommBox Plus to a Communicator	16
3.8	Connecting the CommBox Plus to a Controller or RLink	16
3.8.1	Controller to Junction Box Wiring	17
3.8.2	RLINK One to Junction Box Wiring	19
3.9	CommBox Plus to Junction Box Wiring	20
3.10	Wiring Topologies	21
3.11	Termination.....	22
3.11.1	Termination Topologies	22
3.11.2	Termination Wiring	24
4	TECHNICAL DATA	25
4.1	CommBox Plus Specifications	25
4.2	Junction Box Specifications	26
5	GROUP MANAGEMENT	27
5.1	What is a Group?	27
5.2	Activating the Group.....	28
5.3	Log In.....	29

5.4	Attaching the Farm to a Group	30
5.4.1	No Existing Groups.....	30
5.4.2	Groups Exist	30
5.5	Local Log In.....	31
6	ROTEMNET WEB.....	33
6.1	Sign In.....	33
6.1.1	Standard Login	33
6.1.2	Private Server.....	34
6.2	My Farm Groups	35
6.2.1	Details (Optional).....	37
6.2.2	Users.....	38
6.2.2.1	Existing Users	38
6.2.2.2	New Users	38
6.2.2.2.1	Creating a New User.....	38
6.2.2.2.2	Inviting a New User	39
6.2.3	Farms.....	40
6.3	Manage Groups	41
6.4	User Settings	42
6.5	RotemNet Farm Management.....	43
6.5.1	Farm Summary and Comparison.....	43
6.5.2	Comparison Screen Appearance	44
6.5.3	RotemNet Screen Appearance.....	45
6.5.4	RotemNet Web Functionality.....	47
6.5.4.1	Farm Settings Tab	47
6.5.4.1.1	Farm Settings.....	47
6.5.4.1.2	Push Notifications	49
6.5.4.1.3	Local Users	50
6.5.4.1.4	Data Collect.....	50
6.5.4.1.5	Activity Log.....	50
6.5.4.1.6	General Settings.....	50
6.5.4.2	House Scan Tab	51
6.6	Software Upgrade	51
6.6.1	Upgrade Procedure	51
6.6.2	User Information	53
6.7	About Tab	53
7	DIAGNOSTICS.....	54
8	CONTROLLER FUNCTIONALITY	57
8.1	Modal	57
8.2	Bird Inventory	60
8.3	Growth Day Send to All	60

9 APPENDIX A: GENERATING AN ACTIVITY LOG 62

10 APPENDIX B: DATA COLLECTION 68

 10.1 Centralized Collection..... 68

 10.2 Defining the FTP/SFTP server 70

11 APPENDIX C: ADDING A SIM CARD/MODEM.....72

12 WARRANTY75

1 Introduction

1.1 Disclaimer

Munters reserves the right to make alterations to specifications, quantities, dimensions etc. for production or other reasons, subsequent to publication. The information contained herein has been prepared by qualified experts within Munters. While we believe the information is accurate and complete, we make no warranty or representation for any particular purposes. The information is offered in good faith and with the understanding that any use of the units or accessories in breach of the directions and warnings in this document is at the sole discretion and risk of the user.

1.2 Introduction

Congratulations on your excellent choice of purchasing a CommBox Plus!

In order to realize the full benefit from this product it is important that it is installed, commissioned and operated correctly. Before installation or using the unit, this manual should be studied carefully. It is also recommended that it is kept safely for future reference. The manual is intended as a reference for installation, commissioning and day-to-day operation of the Munters equipment.

1.3 Notes

Date of release: July 2019

Munters cannot guarantee to inform users about the changes or to distribute new manuals to them.

All rights reserved. No part of this manual may be reproduced in any manner whatsoever without the expressed written permission of Munters. The contents of this manual are subject to change without notice.

2 Introduction to the CommBox Plus

NOTE This manual details how to set up and run the CommBox Plus. The controllers' software programs are documented in separate manuals.

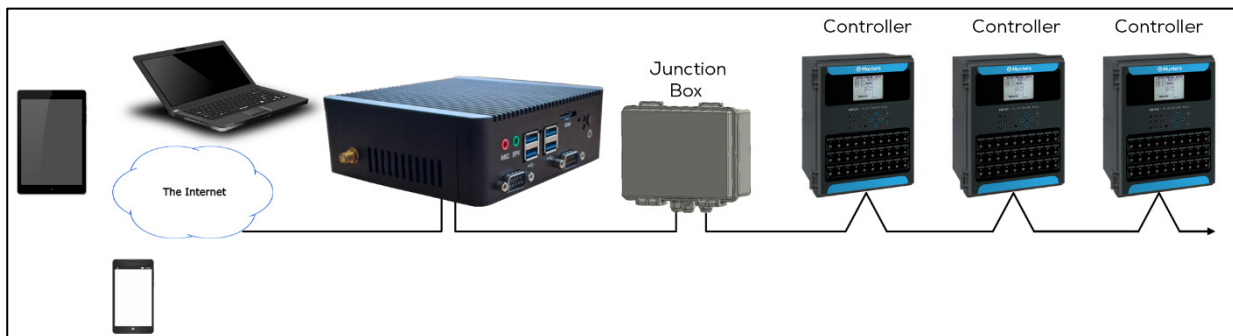

Figure 1: CommBox Plus/Controller Block Diagram

CommBox Plus provides complete access to your Munters controllers, including monitoring and control capabilities, from any device, anywhere. From one computer, tablet, or smartphone, you can manage an entire network.

- Cloud-based access to controllers
 - Multiple, simultaneous users have network access
- Multiple communication pathways
 - Built-in internet and telephone connectivity
 - Cellular Connectivity
- Local communication via wired or wireless communication
- Status reports provide critical information on house functions and animal statistics
- Push notifications

In addition, CommBox Plus can act as an add-on for users wanting to add web-access to legacy Communicator units.

2.1 Ordering

Each CommBox Plus has one software package:

- Poultry (P/N: 904-07-00016 CommBox Plus-POU-EN-ROT)

2.2 Junction Box



Connecting a CommBox Plus directly to a controller requires a Junction Box. There are two options:

- RS-232 Network: P/N 904-99-00036 COMMBOX PLUS -POU- JUNCTION BOX RS232
- RS-485 Network: P/N 904-99-00037 COMMBOX PLUS -POU- JUNCTION BOX RS485

2.3 What Comes in the Package

CommBox Plus	
Junction Box	
120Ω resistor for termination	
Antenna	
12 VDC Power Supply	
24 VDC Power Supply	

'EPROM for Communicator upgrade. When connecting CommBox Plus directly to Communicator, upgrade the Communicator software using the EPROM supplied.

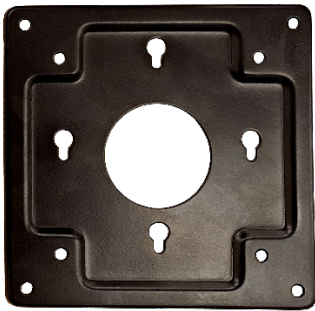
<ul style="list-style-type: none">• Mounting Pieces	
<ul style="list-style-type: none">○ 4 screws	
<ul style="list-style-type: none">○ 4 mounting bolts	
<ul style="list-style-type: none">○ 1 mounting bracket	

2.4 Block Diagrams

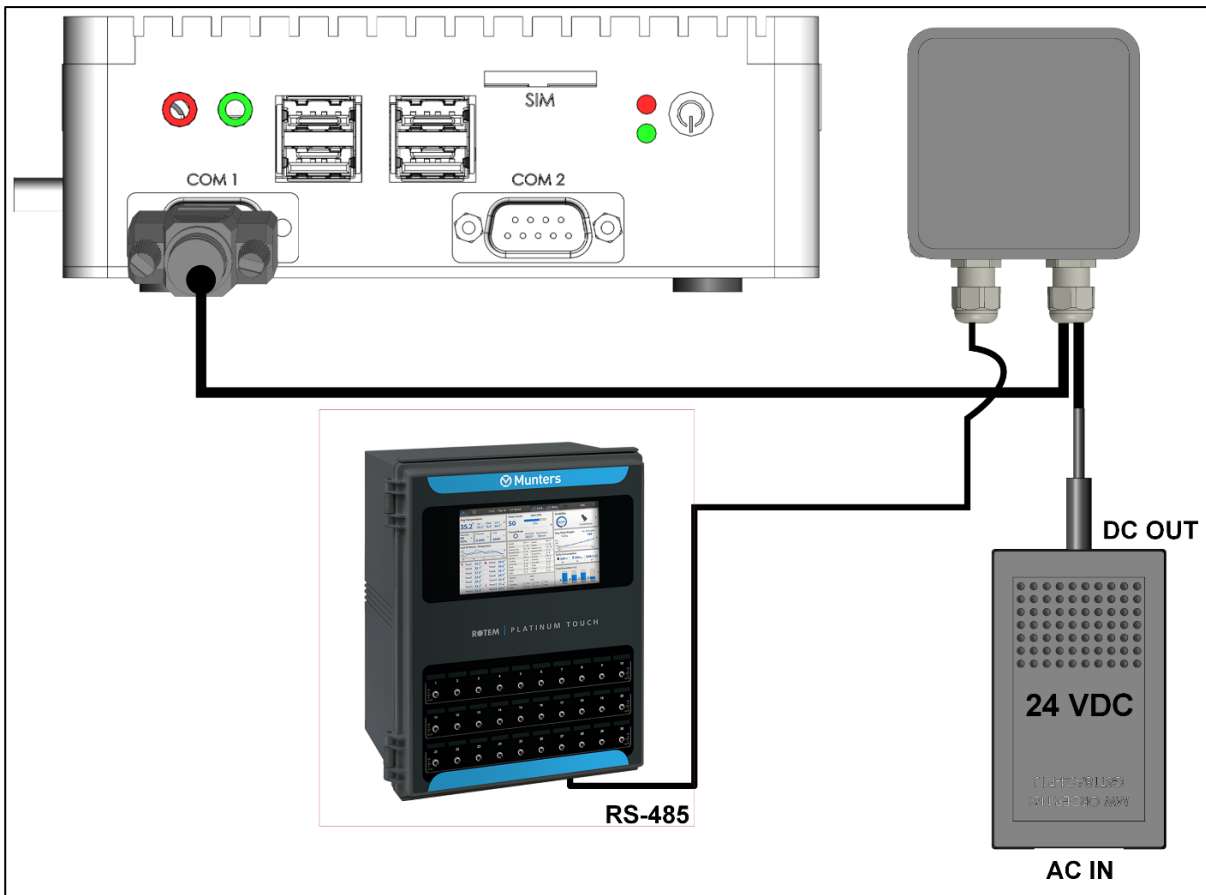

Figure 2: CommBox Plus Block Diagram/Controller & 24 VDC PS

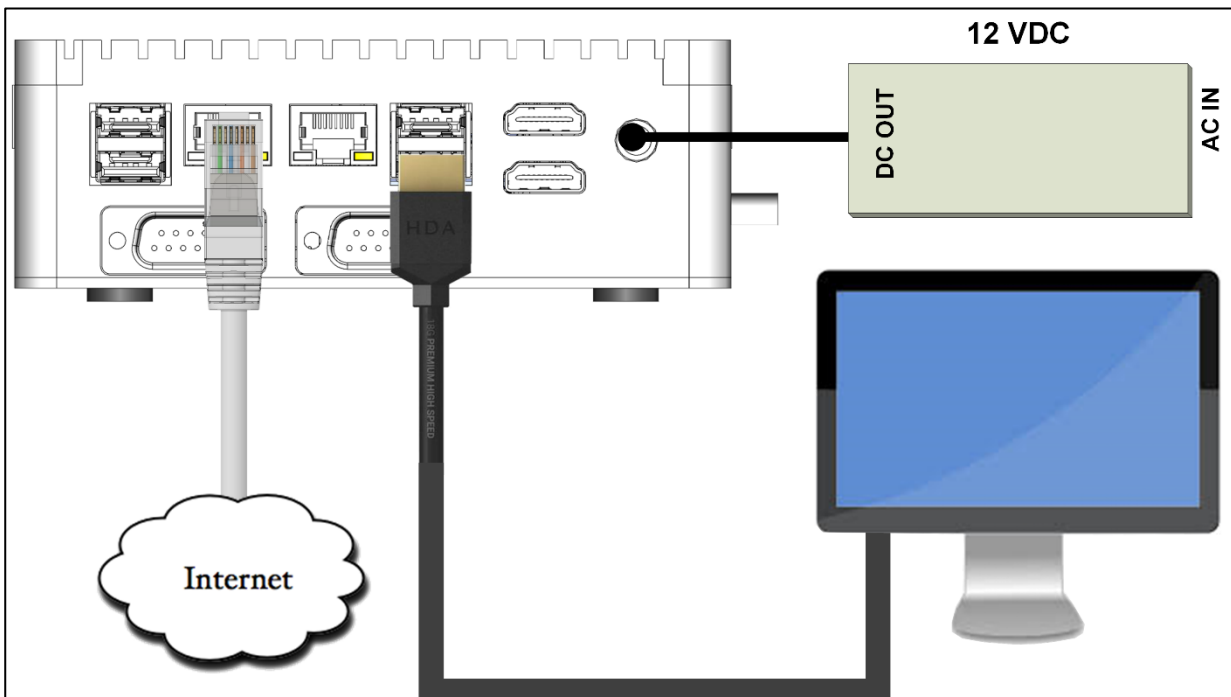

Figure 3: CommBox Plus Block Diagram/Screen & 12 VDC PS

3 Hardware Installation

This document details how to install Munters' CommBox Plus unit. Installation consists of:

- Precautions
- CommBox Plus Ports
- Mounting the CommBox Plus
- Connecting the CommBox Plus to the Internet
- SIM Card Connectivity
- Connecting the CommBox Plus to a Peripheral Device
- Connecting the CommBox Plus to a Communicator
- Connecting the CommBox Plus to a Controller or RLink
- CommBox Plus to Junction Box Wiring
- Wiring Topologies
- Termination

NOTE No software installation is required.

3.1 Precautions

Observe the following precautions when using your unit.

- Keep the CommBox Plus as far as possible from heavy contactor boxes and other sources of electrical interference.
- Do not connect communication wire shields, which go from one house to another at both ends. Connect them at one end only. Connection at both ends can cause ground loop currents to flow, which reduces reliability.
- The COM connection for communications is not the shield wire. The COM, RX and TX wires must connect to each other at all controllers.

3.2 CommBox Plus Ports

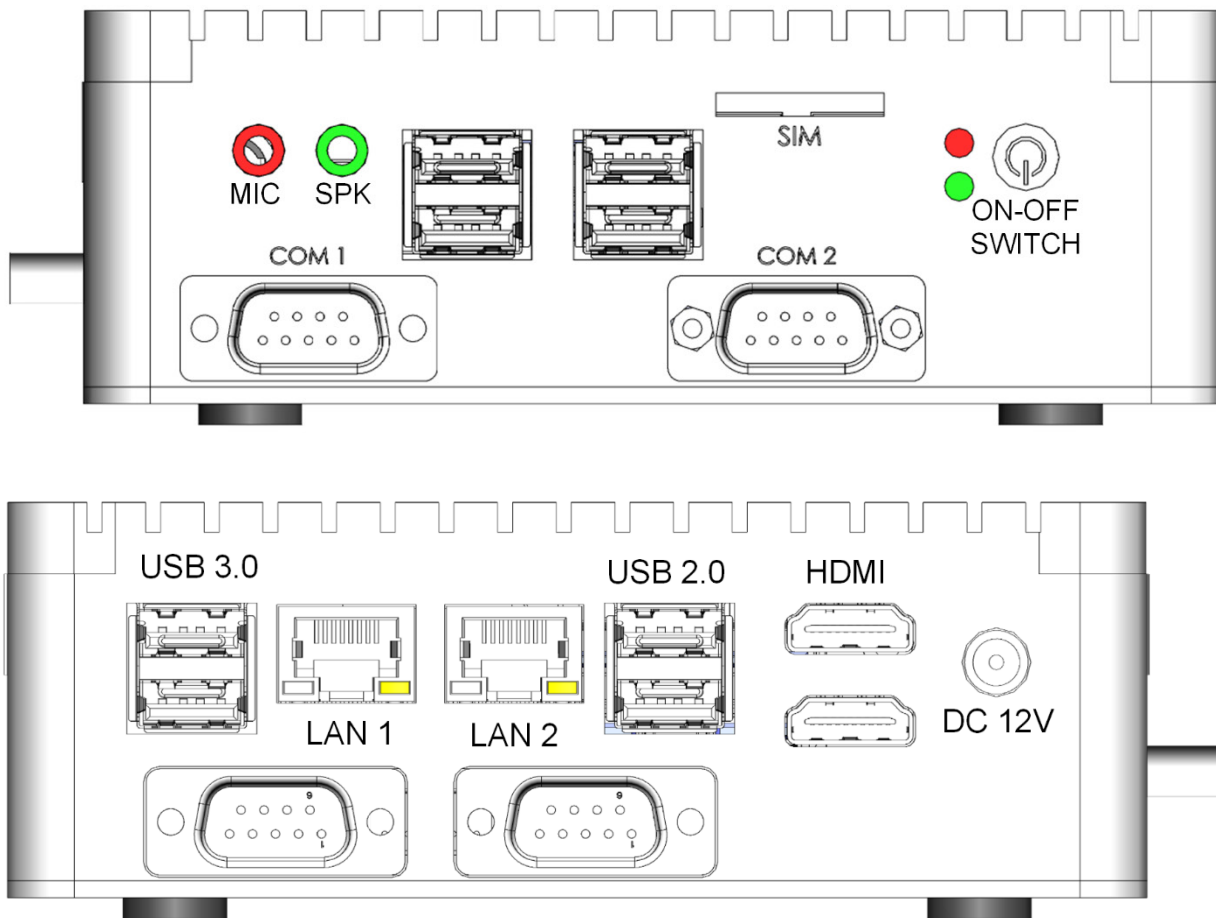

Figure 4: Front and Rear View

3.3 Mounting the CommBox Plus

1. Using the screws provided, place the bracket on a wall.

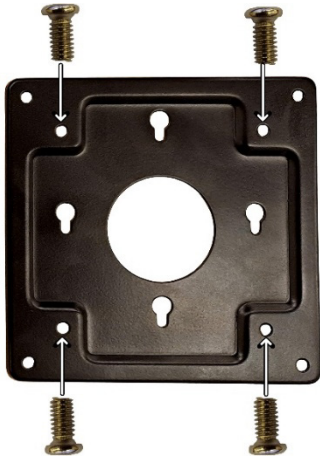

Figure 5: Bracket Screws

2. On the back of the CommBox Plus, screw in the mounting screws.

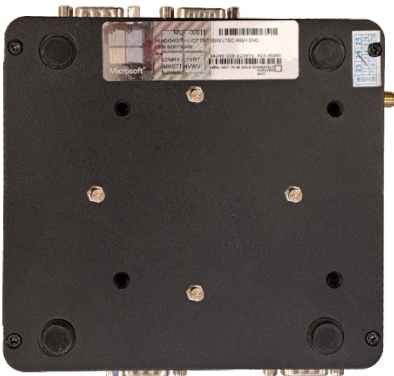

Figure 6: Mounting Screws

3. Place the unit on the mounting bracket.

3.4 Connecting the CommBox Plus to the Internet

- Connect the CommBox Plus to your Internet connection/modem.

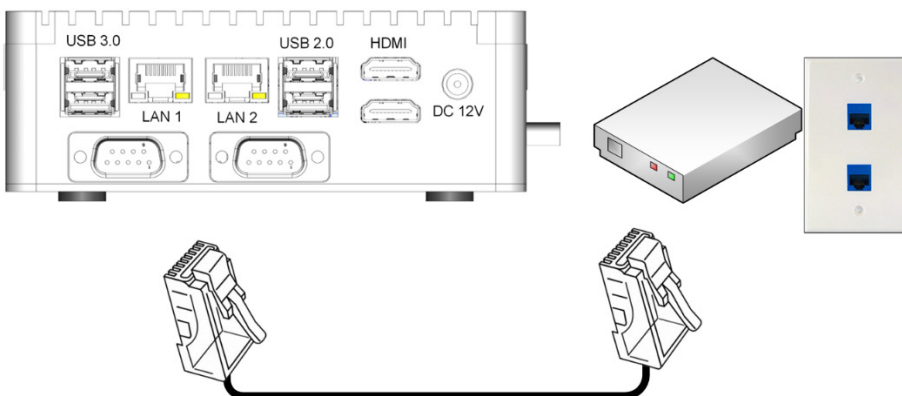

Figure 7: Internet Connection

3.5 SIM Card Connectivity

- CommBox Plus SIM internet connectivity works as a backup to a standard LAN network. However, the SIM card will only function when there is no actual LAN connection (meaning, the LAN service is weak or there is no LAN service in a particular area).
- Munters recommends configuring the SIM card in the dealer office before installing the CommBox Plus in the field. When configuring the SIM card the following information (available from your local cellular service provider) is required:
 - Cellular provider name = XXXX
 - APN = XXXX

Please contact your dealer or Munters' Global Support team for technical assistance. Go to <https://munters.zendesk.com/hc/en-us/categories/360001140792-Communication-Hardware> to submit a ticket to the Global Support team.

- A 5 Mbps upload/download speed (minimum) is required to ensure secure connectivity between the CommBox Plus and controllers.
- Attach the antenna to one of the antenna ports as indicated.

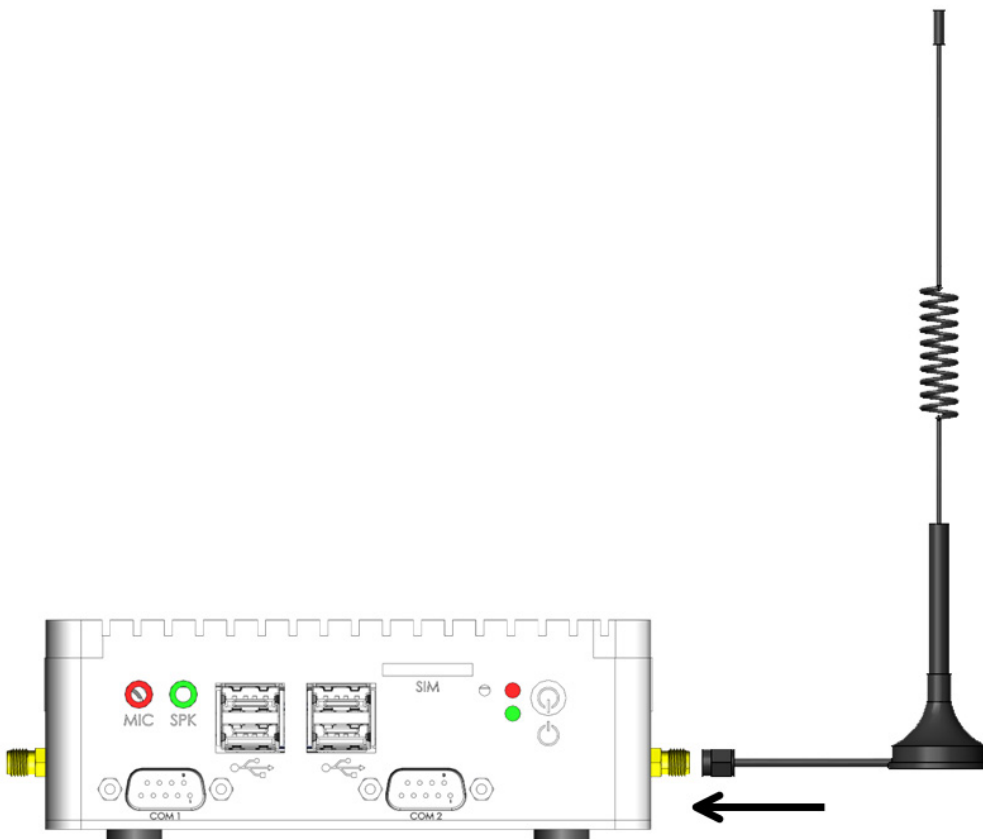

Figure 8: Antenna Connection

3.6 Connecting the CommBox Plus to a Peripheral Device

If required, connect a screen or mouse to the CommBox Plus (via the USB/HDMI ports).

NOTE Connect the screen to the CommBox Plus using an HDMI cable only. Do not use any other type of cable and an HDMI adapter.



Figure 9: Peripheral Devices (Screen)

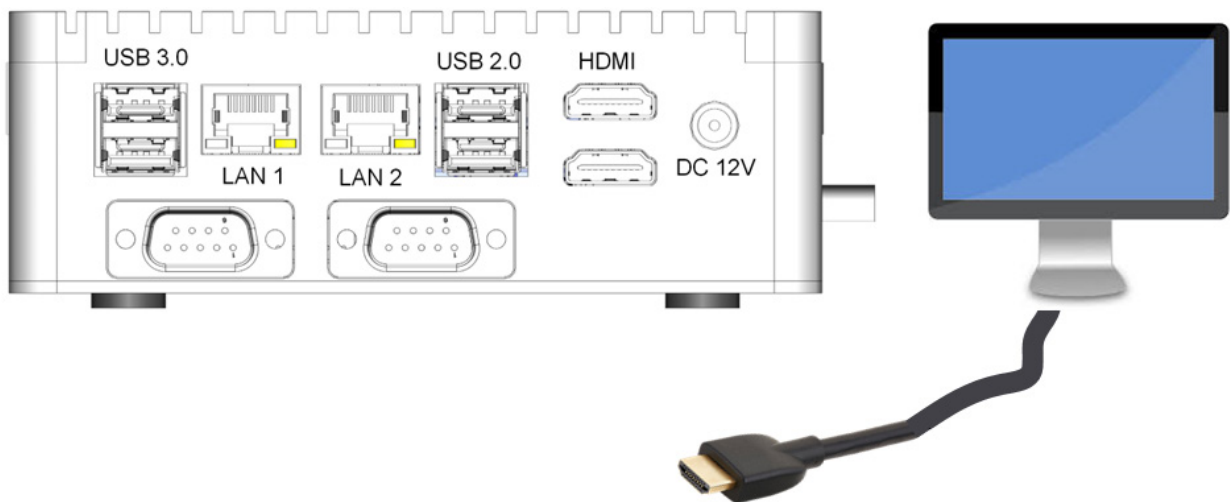

Figure 10: Peripheral Devices (Screen)

3.7 Connecting the CommBox Plus to a Communicator

- Connect the CommBox Plus to a Munters Communicator using a standard USB cable (supplied with the Communicator unit).



NOTE Communicator requires the Communicator Serial Card (P/N: C-COMM-SERIAL) to support the CommBox Plus. Refer to Document #112189 for details on upgrading the Communicator.

3.8 Connecting the CommBox Plus to a Controller or RLink

The only step in installing a CommBox Plus that requires wiring is if the CommBox Plus is connected directly to a controller (instead of a Communicator). In this situation the CommBox Plus must be wired to the controller communication card, via the Junction Box.

- Controller to Junction Box
- RLINK One to Junction Box Wiring

WARNING! *Disconnect the power before beginning!*

WARNING! *Only an authorized electrical technician may perform this procedure!*

3.8.1 CONTROLLER TO JUNCTION BOX WIRING

In the controller, connect the CommBox Plus to the controller's communication card. Refer to the following illustrations.

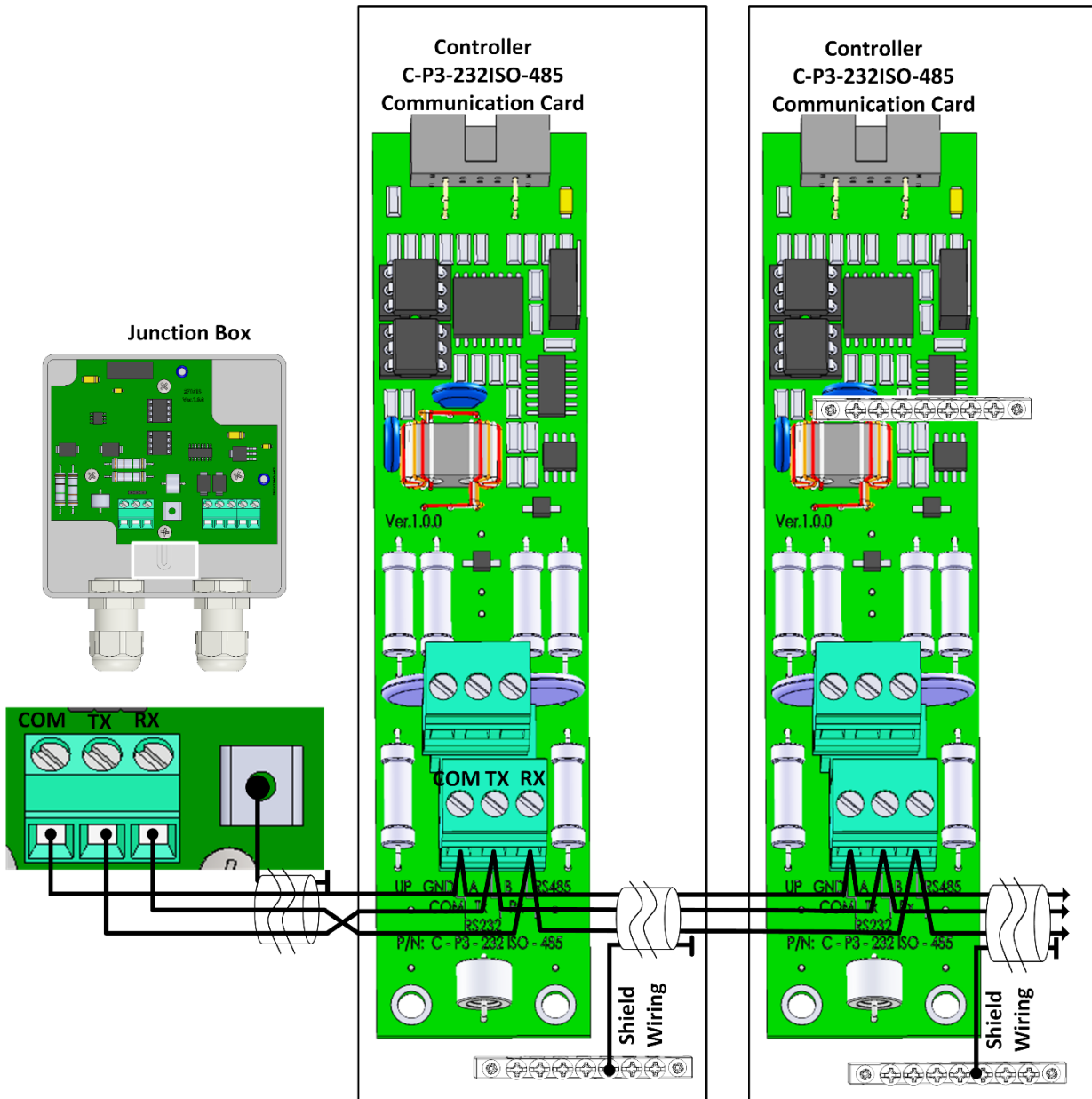

Figure 11: RS-232 Wiring

- Connect the wiring as follows:
 - COM to COM
 - The CommBox Plus TX port is connected to Controller's RX port.
 - The CommBox Plus RX port is connected to Controller's TX port.
- The cable between the CommBox Plus and the controller should be a 3 Wire Shielded Cable (22 AWG minimum).
- Connect the cable shield wire to the controller ground strip.

CAUTION Connect one end of the cable's shield only (the other end must be open). Each controller should be chain connected to the same wire, resulting in a long ground cable without ground loop.

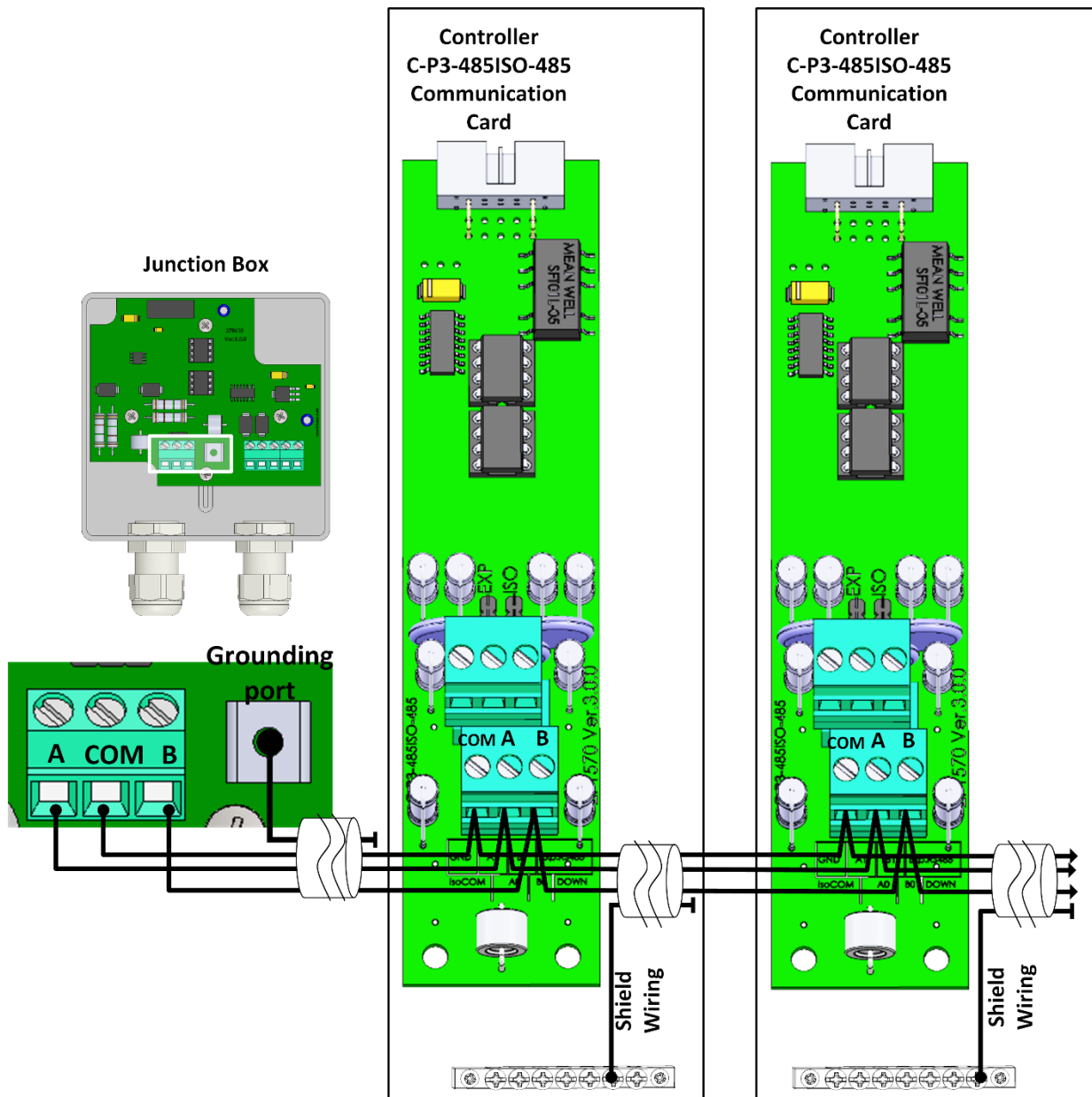

Figure 12: RS-485 Wiring

- The cable between the external connection box and the controllers should be a 3-wire twisted shielded cable (22 or 24 AWG).
- Connect the wiring as follows:
 - COM to COM
 - CommBox Plus A port is connected to Controller's A port.
 - The CommBox Plus B port is connected to Controller's B port.
- The final controller in any chain or branch may require a 120-ohm terminator. Refer to Termination, page 22.
- Connect the cable shield wire to the controller ground strip.

CAUTION Connect one end of the cable's shield only (the other end must be open).. Each controller should be chain connected to the same wire, resulting in a long ground cable without ground loop.

3.8.2 RLINK ONE TO JUNCTION BOX WIRING

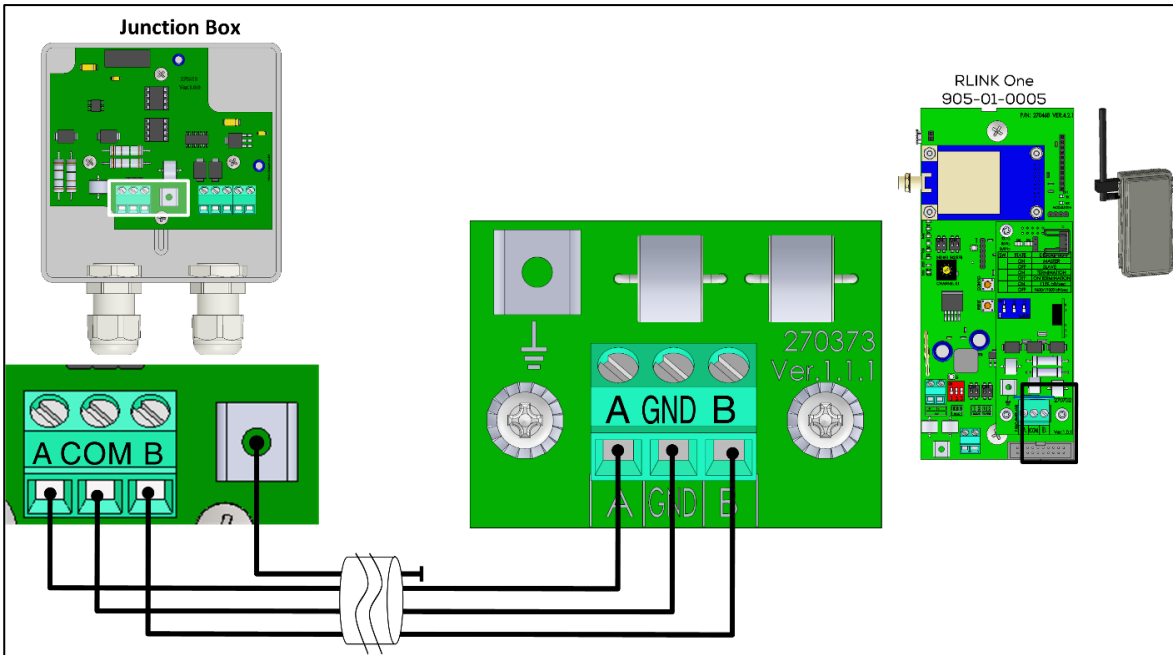

Figure 13: RLink One Wiring

NOTE RLINK One supports RS-485 infrastructure only.

- The cable between the external connection box and the controllers should be a 3-wire twisted shielded cable (22 or 24 AWG).
- Connect the wiring as follows:
 - COM to COM
 - CommBox Plus A port is connected to Controller's A port.
 - The CommBox Plus B port is connected to Controller's B port.
- The final controller in any chain or branch requires a 120-ohm terminator. Refer to Termination, page 22.
- Connect the cable shield wire to the controller ground strip.
- Connect the wiring according to the following table:

Port	Color Wire	Port	Color Wire
COM	Brown	+	Red
TX	Green	-	Black
RX	White	COM	Shield wire

3.10 Wiring Topologies

When connecting the CommBox Plus to controllers via an RS-485 infrastructure, use one of the following allowed topologies to ensure signal integrity.

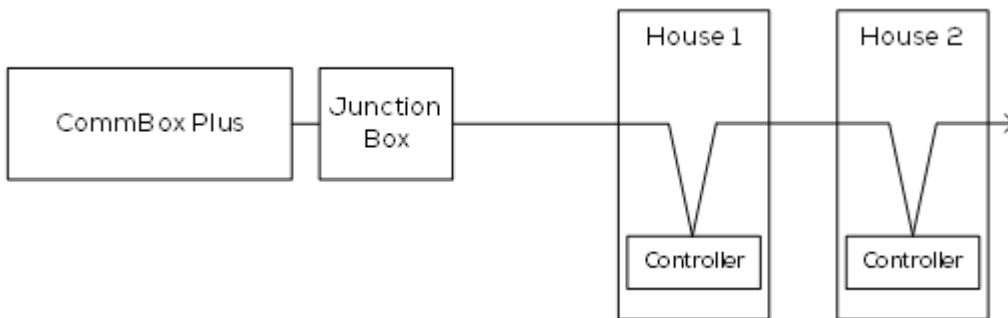

Figure 16: Direct connections

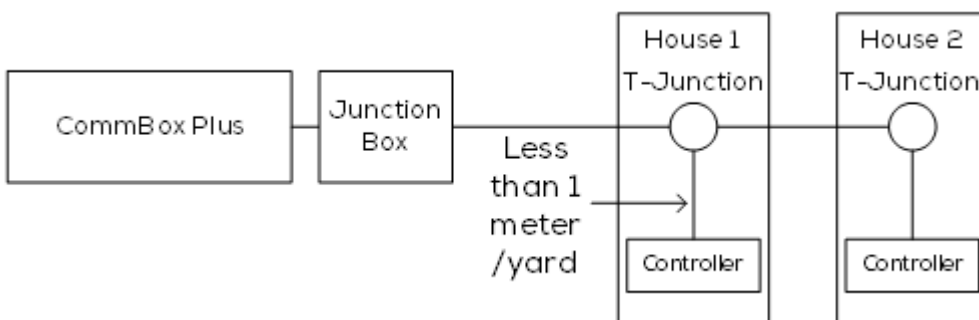

Figure 17: T-Junction (permitted)

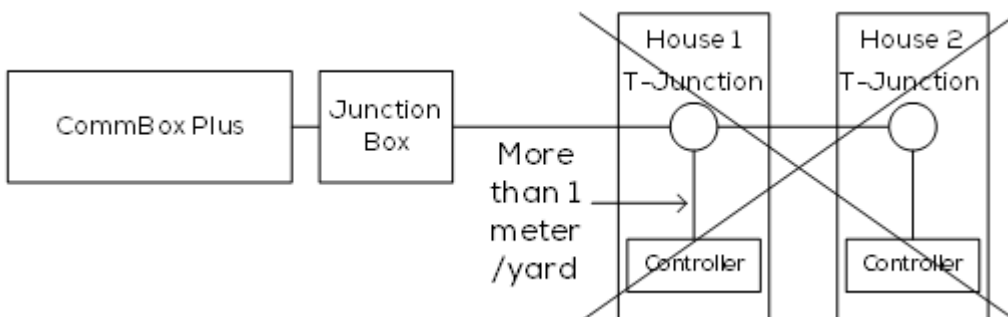

Figure 18: T-Junction (not permitted)

NOTE: When using RS-232, there is no restriction on the distance between the T-Junction and the controller.

3.11 Termination

Termination, installing 120-ohm termination resistors at the beginning and end units of each chain of CommBox Plus and controllers, ensures reliable communication in RS-485 infrastructures. The following illustrations show where to install the resistors. Depending on the topology, install the resistors in the Junction Box, the terminal controller, or the Munters Repeater.

Termination is recommended when the distance between the Junction Box and the final controller is more than 100 meters/330 feet. Munters Junction Box is supplied with a jumper and a 120 ohm resistor that can be installed in those installations (the jumper is placed in the Junction Box (see Figure 24, page 24), the resistor is installed in the controller). Termination may not be required in shorter installations.

- Termination Topologies
- Termination Wiring

3.11.1 TERMINATION TOPOLOGIES

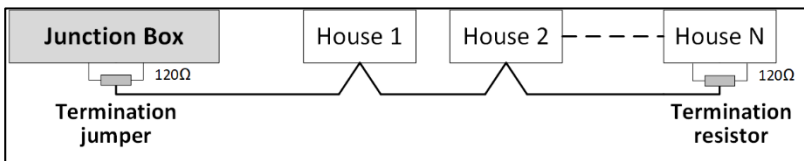

Figure 19: Topology 1: CommBox Plus/House Termination

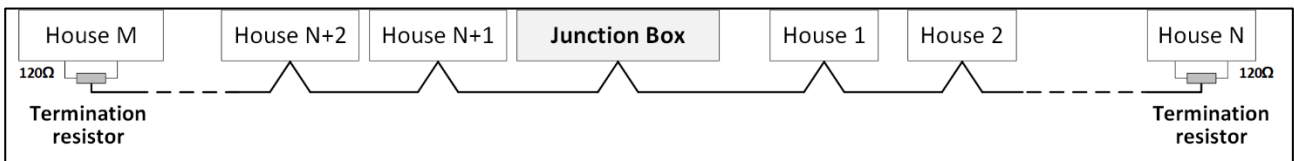

Figure 20: Topology 2: House Termination

The following two topologies require Munters RS-485 Repeaters.

CAUTION Install the repeater within one meter of the CommBox Plus T-Box.

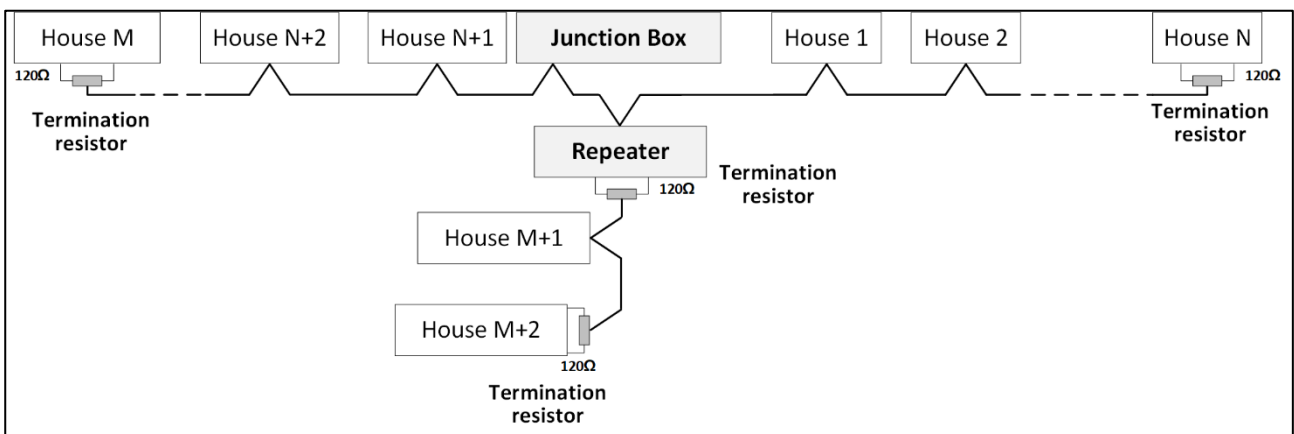

Figure 21: House and Repeater Termination

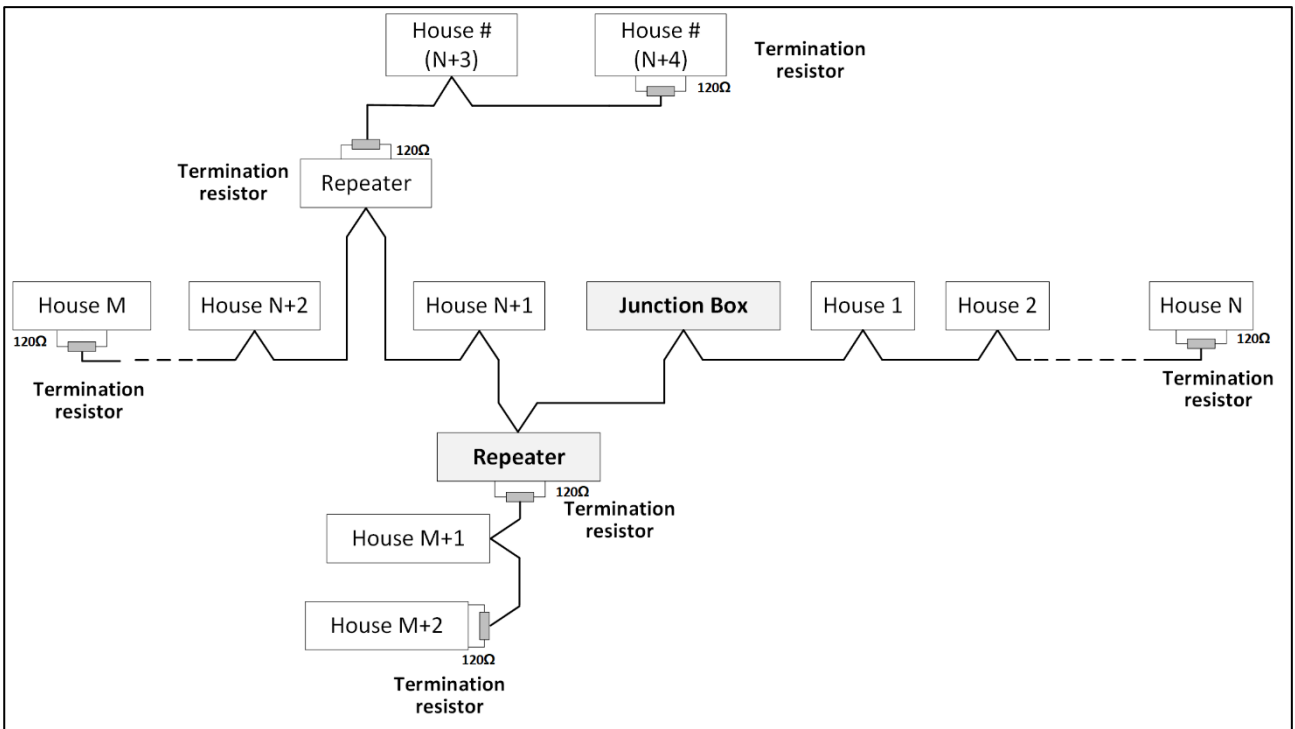

Figure 22: House and Multiple Repeaters Termination

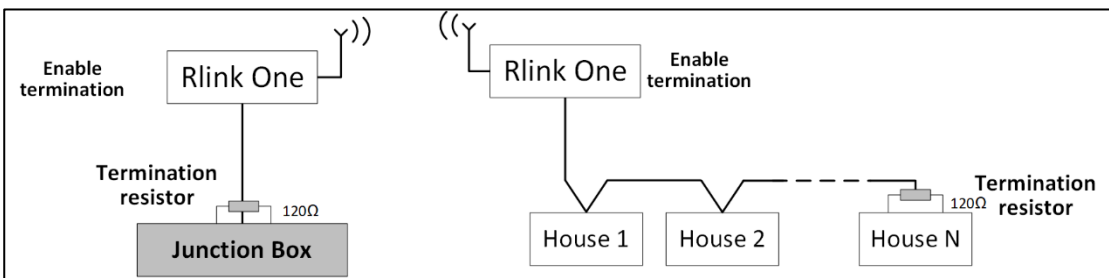

Figure 23: RLink One and House Termination

NOTE When using an RLINK One, refer to the RLINK One Manual for detailed information on RLINK One termination.

3.11.2 TERMINATION WIRING

- CommBox Plus: Place the jumper as shown below.

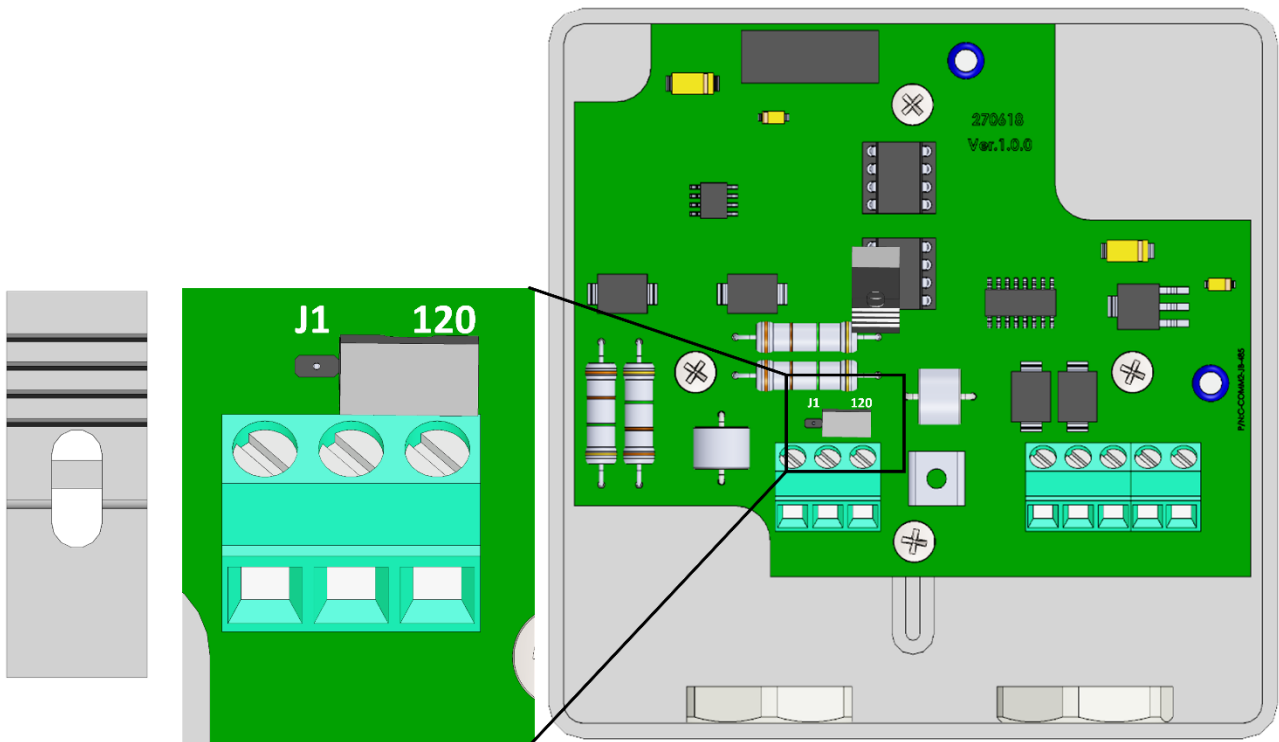

Figure 24: Junction Termination

- Repeaters: Move the S2 dipswitch on the Output card to ON.

RS-485 Repeater Card

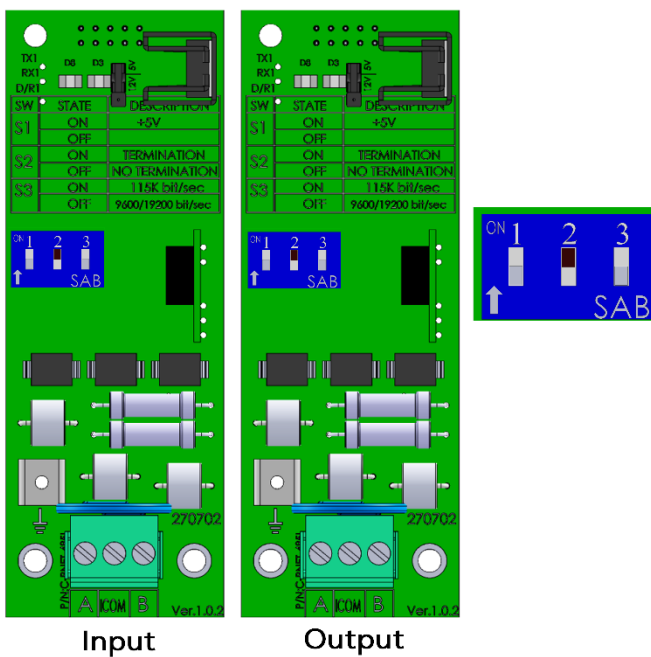





Figure 25: Repeater Termination

4 Technical Data

- CommBox Plus Specifications
- Junction Box Specifications

4.1 CommBox Plus Specifications

Parameter	Detail
Power Supply	
Power Consumption	<ul style="list-style-type: none"> • 12V DC +/-20% • Power Adapter: SC 12VDC, 5A/60W (100 ~ 240V)
CAUTION Unit should be powered by Limited Energy Source per IEC 61010-1 or Limited Power Source per IEC 60950-1 or IEC 62368-1	
Temperature Range	
Operating Temperature Range	-20° to +65° C / -4° to +15
Storage Temperature Range	15° to 35° C / 59° to 95° F
Ethernet	
LAN	Two (2) 10/100/1000/ Mbps Realtek 8111F ports
Internet bandwidth	5 Mbps upload/download speed (minimum)
SIM Card Requirements	
Cellphone SIM Card	4G (LTE CAT1)
Cell Package	Depends on user requirements. Please consult with your dealer.
Environmental Specifications	
<ul style="list-style-type: none"> • Indoor use only • Altitude: -400 m to 2000 m • Relative Humidity: 5 – 95% • Main supply voltage fluctuation up to 5% • Overvoltage category: OVCII • Pollution degree: PD2 • Ingress Protection: IPX0 	
Housing	
Metal Box Dimensions (W x H x D)	136 x 126 x 39 mm (without wall-mount bracket)
Weight	1.5 Kg/3.3 lbs.

Parameter	Detail
Input/Output:	
COMM	Two RS-232 Ports
USB	One USB 3.0 port Three USB 2.0 ports
Certification	
  	

4.2 Junction Box Specifications

Power Supply	
Junction Box Power Input	24 VDC, 30 mA
CAUTION <i>Unit should be powered by Limited Energy Source per IEC 61010-1 or Limited Power Source per IEC 60950-1 or IEC 62368-1</i>	
Temperature Range	
Operating Temperature Range	0° to +45° C / 32° to 113° F
Storage Temperature Range	-10° to +70° C / 14° to 158° F
Environmental Specifications	
<ul style="list-style-type: none"> • Indoor use only • Altitude: -400 m to 2000 m • Relative Humidity: 0 – 90% • Main supply voltage fluctuation up to 5% • Overvoltage category: OVCII • Pollution degree: PD2 • Ingress Protection: IP50 	

5 Group Management

When using the CommBox Plus to connect to your farm(s), you must:

- create a group
- define user rights

- What is a Group?
- Activating the Group
- Log In
- Attaching the Farm to a Group
- Local Log In

5.1 What is a Group?

NOTE A group is the virtual device used to manage your farms. Using the RotemNet Web application, the group manager defines each user's permissions (which farms he can see and what functions he can carry out).

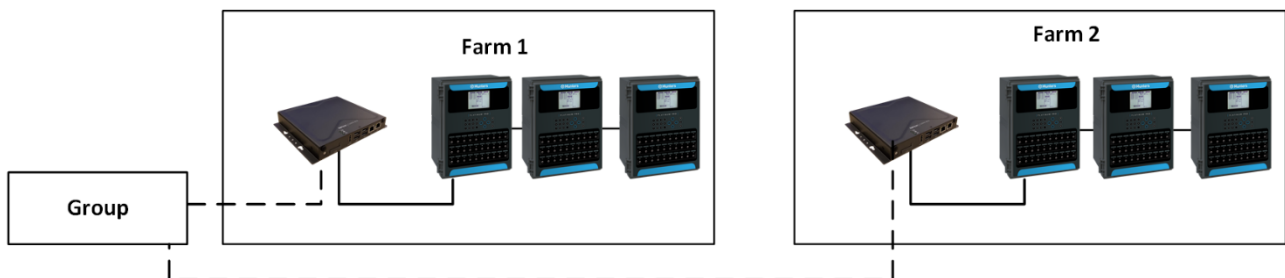

Figure 26: Group Example

As an example, an account manager has sent up two Groups and wants to add three different users to his account.

1. User 1 is assigned access rights to Farm 1.
2. User 2 is assigned access rights to Farm 2.
3. User 3 is assigned access rights to Farm 1 and Farm 2.
4. In addition, User 1 is also assigned access rights to Farm 3, which is in an entirely different group.

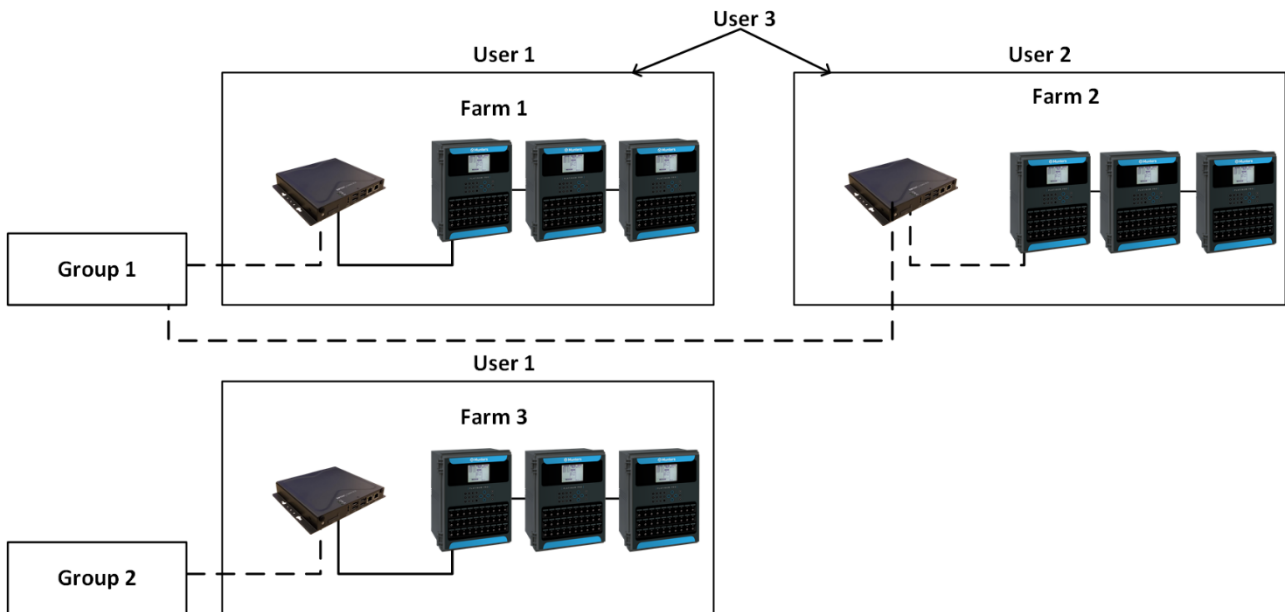

Figure 27: Assigning Farms to Groups

Any combination is possible.

5.2 Activating the Group

The first time that you power up a CommBox Plus, you need to activate a group.

1. Connect the CommBox Plus to a screen, keyboard, and mouse. Apply power. The Farm Activation screen appears.

The screenshot shows the 'Farm Activation' screen. At the top, it displays the 'ROTEM' logo and 'a Munters company'. Below the logo, the title 'Farm Activation' is centered. The screen contains several input fields: 'Farm Name' with a text box containing 'My New Farm Name'; 'Farm Type' with a dropdown menu set to 'Poultry'; 'Baudrate' with a text box containing '9600' and an 'Edit' button; 'Com Port' with a text box containing 'COM1' and an 'Edit' button; and 'Number Of Houses To Be Scanned' with a dropdown menu set to '1'. At the bottom right, there is a blue 'Activate' button.

Figure 28: Activation Screen

2. Fill in the fields:

Name: Type in the farm name.

Farm Type: Choose the type from the drop-down list.

Baud rate/Com Port: CommBox Plus has default settings of 9600 BPS/COM Port 1, respectively. If you need to change these settings, click on the pencil and choose a setting from the drop-down list.

NOTE Verify that the CommBox Plus and controller baud rates are the same.

Number of Houses: Select the number from the drop-down list.

NOTE You can edit all these settings in RotemNet Web.

3. Click Activate. A pop up appears asking if you want to scan your farm houses.
Click Start Scan if the CommBox Plus is connected to the controllers.
Click Cancel if the CommBox Plus isn't connected.
4. A second pop-up appears, asking if you want to connect to the Web.
Click on the Connect to Web to connect your CommBox Plus to the web. This enables remote monitoring and control.
If you want, you can be reminded to scan at a later time. (Alternatively, click Don't Remind Me Later).

NOTE *If you decide not to connect now, you can always connect by clicking on the RotemNet Web Tab Farm Setting.*

As the Group administrator, you can invite other people to join the group as well as define their access rights. This is done in RotemNet Web itself.

5.3 Log In

- If you have a RotemNet Web user name, log in.

Figure 29: Login Screen

1. If you are a new user, click Sign up now. The following screen appears.

Figure 30: Create a New User Screen

2. Fill in all fields.
3. Click Create a User. The following screen appears.

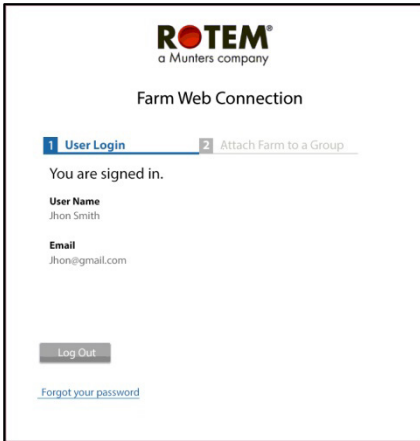

Figure 31: Sign In Screen (Example)

NOTE To disconnect from the web, click the [Disconnect](#) button (refer to page 48).

5.4 Attaching the Farm to a Group

After signing in one of the following screens appears:

- No Existing Groups
- Groups Exist

5.4.1 NO EXISTING GROUPS

1. If there are no existing groups for this farm, the following screen appears:



Figure 32: No Existing Group Screen

2. Write the name of the farm group that you want to create and click **Attach to Group**.

5.4.2 GROUPS EXIST

If the farm is part of a group or if the owner has created groups do one of the following:

- Check the radio box next to the group to which you want to attach your farm and click **Attach to Group**.

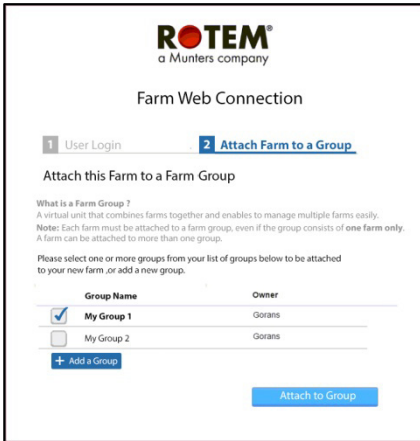

Figure 33: Attach Farm to Group Screen

- To add an additional group, type in the Group Name and click Add a Group.

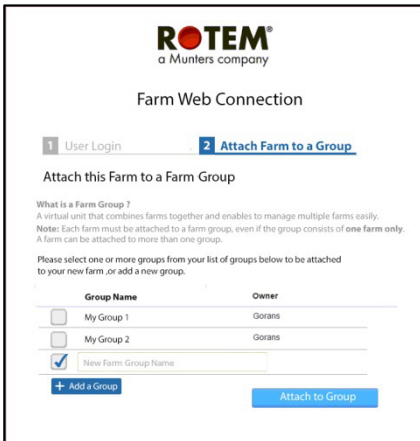

Figure 34: Add a Group Screen

5.5 Local Log In

In the event that:

- You restart your system
- CommBox Plus logs off (this can happen automatically if you are not using system)
- Power goes off

you need to log on to the CommBox Plus locally. The username and password of this login are different from the ones used when logging on to the Web.

ROTEM[®]
a Munters company

RotemNet Web

User Name

Password

Farm Name

Language

Figure 35: Farm Settings

- Enter the user name and password. The defaults are:
User name: "Farm Owner"
Password: "admin"

NOTE The user name cannot be changed. You can change the password after logging in.

NOTE After logging in locally, you will need to log in to the Web (Log In, page 29).

6 RotemNet Web

The following sections describe how to use the RotemNet Web functions. Actual controller functions are described in the Platinum Touch/Rotem One manual.

- Sign In
- My Farm Groups
- Manage Groups
- RotemNet Farm Management
- Software Upgrade
- About Tab

6.1 Sign In

There are two ways to sign in:

- Standard Login
- Private Server

6.1.1 STANDARD LOGIN

1. Go to RotemNetWeb.Com.

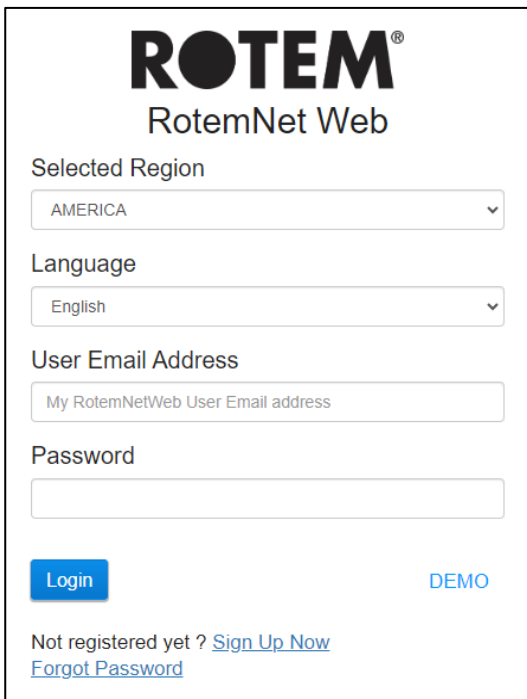

ROTEM[®]
RotemNet Web

Selected Region
AMERICA

Language
English

User Email Address
My RotemNetWeb User Email address

Password

Login DEMO

Not registered yet ? [Sign Up Now](#)
[Forgot Password](#)

Figure 36: Standard Sign In

2. From the drop-down list, select the region closest to you. Proper selection is required to ensure faster response time.

ROTEM
RotemNet Web

Selected Region

AMERICA

ASIA

AMERICA

CHINA

EUROPE

AFRICA

AUSTRALIA

PRIVATE

My RotemNetWeb User Email address

Password

Login DEMO

Not registered yet ? [Sign Up Now](#)
[Forgot Password](#)

Figure 37: Region Selection

3. Enter the email address and password, and click Login.
After signing in, the [My Farm Groups](#) screen appears:

6.1.2 PRIVATE SERVER

If your farm is connected to a private server system:

1. Click Private from the Selected Region. The following screen appears.

ROTEM
RotemNet Web

Selected Region

PRIVATE

Navigate to your private server

example: <https://www.myserver.com> Navigate

Language

English

User Email Address

My RotemNetWeb User Email address

Password

Login DEMO

Not registered yet ? [Sign Up Now](#)
[Forgot Password](#)

Figure 38: Private Server Sign In

2. Enter the server information.

NOTE Dealers provide this information, if relevant.

- After signing in, the [My Farm Groups](#) screen appears:

6.2 My Farm Groups

Click the My Farm Groups to access all groups to which you are participating in, in any capacity.

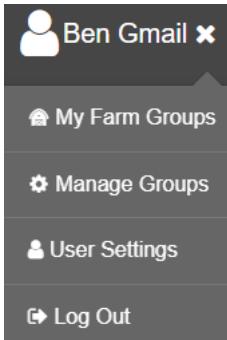

Figure 39: User Group Access

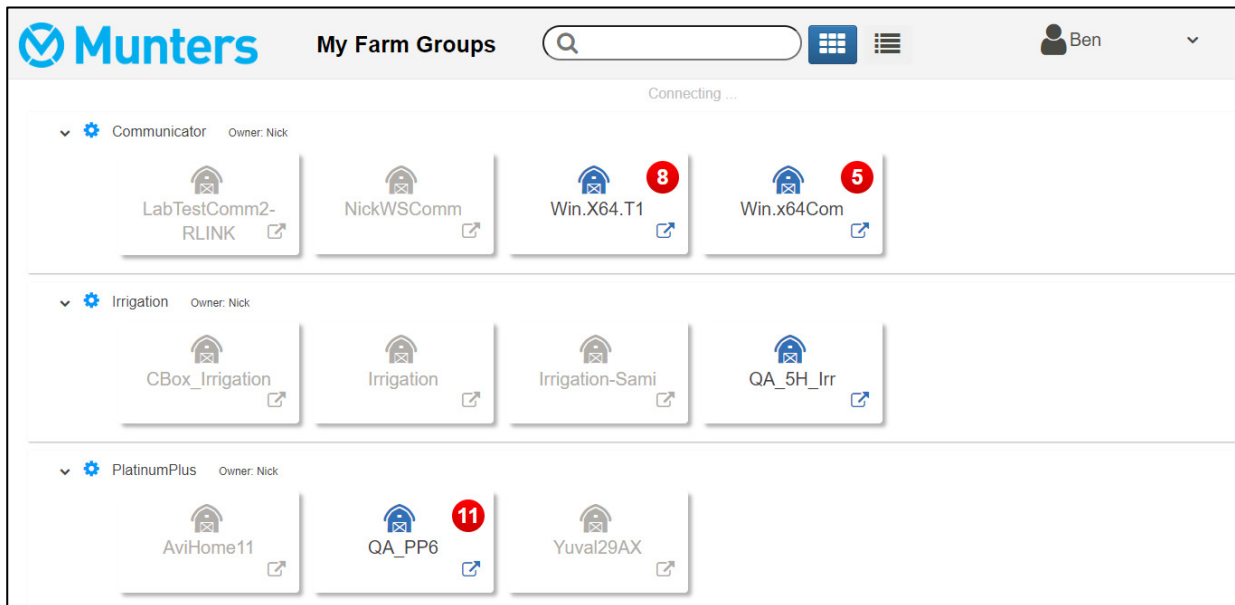

Figure 40: My Groups Screen

The screen shows:

- the groups and their status (on-line/off-line).
- the number of active alarms in each active farm. For example, there are 11 alarms in QA_PP6. Click the icon to see each controller's particular alarms.

Munters		QA_PP6		🔗	
Comparison	House	PP6_H1	PP5_H2	Smart10	
PP6_H1		🔊 On 9 Day 393 Full House	🔊 On 2 Day 99 1st Brood	Day 415 Full House	
PP5_H2					
Smart10	Time	11:52	12:00	12:38	

Figure 41: Controller Alarm Information, Comparison Screen

- To find a particular farm group, search for the name in the search bar.

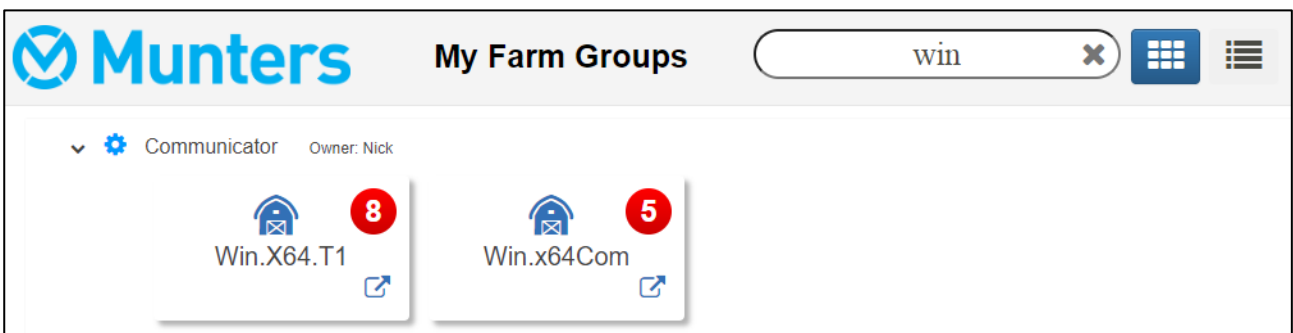



Figure 42: Search Function

- Farms can be displayed in a grid (Figure 43, click ) or in a list (Figure 44, click )

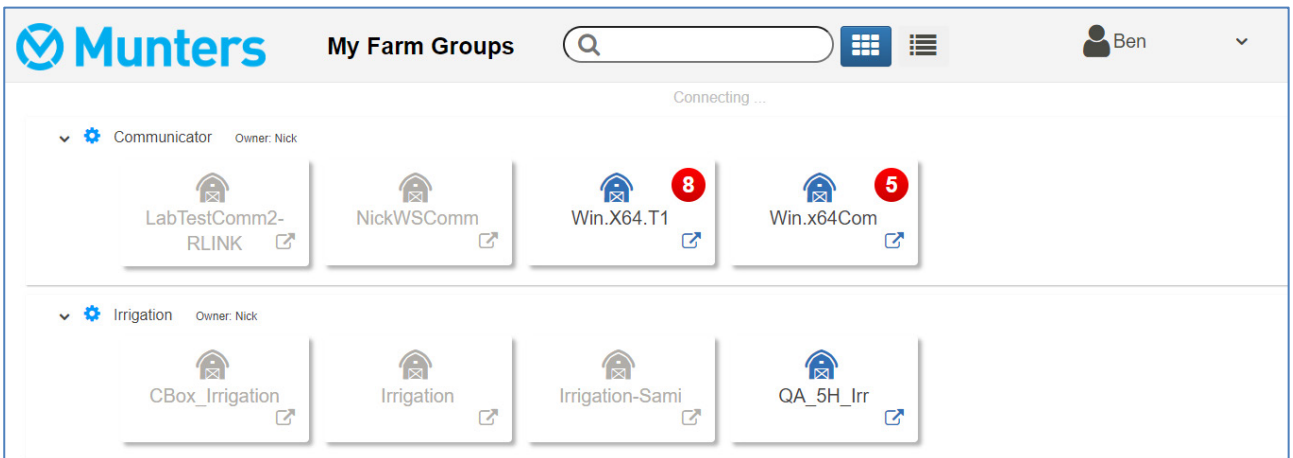

Figure 43: Grid View

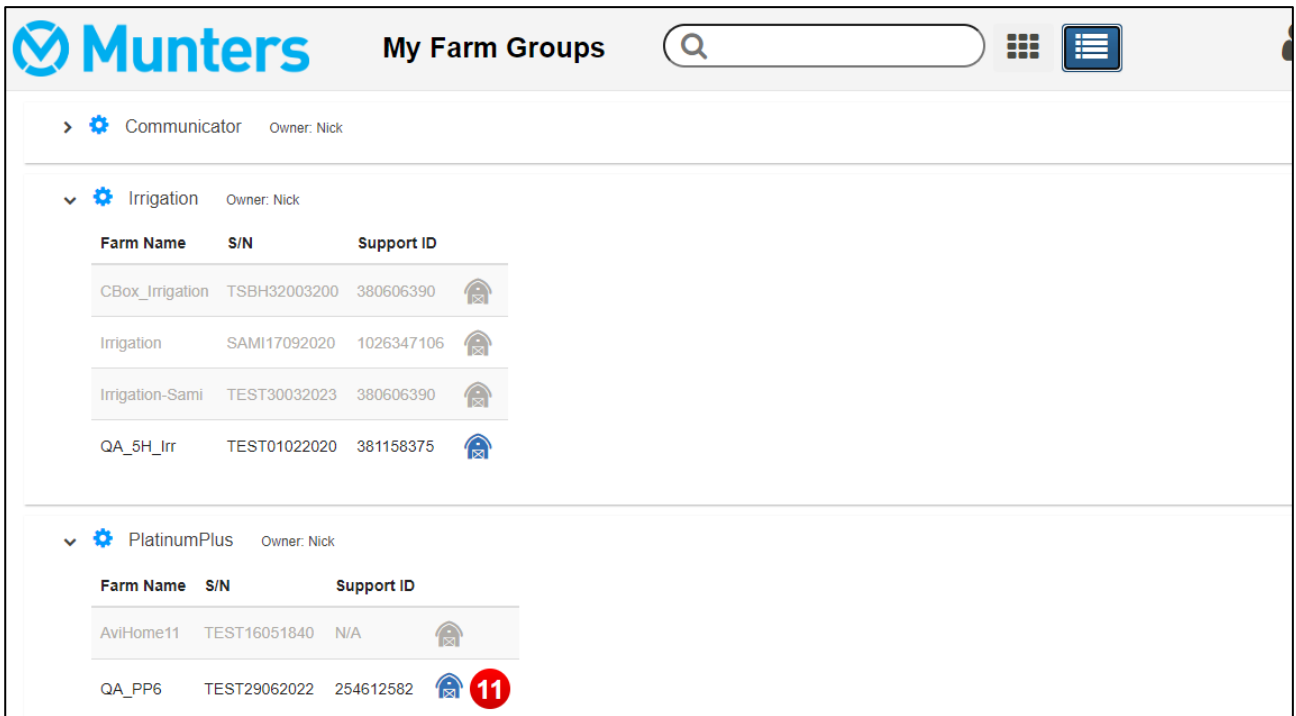



Figure 44: List View

- Click any icon to go to the group's farms (refer to RotemNet Farm Management, page 43).
- Click the settings icon  to view and manage the group's users and farms (Manage Groups, page 41).

6.2.1 DETAILS (OPTIONAL)

On each group, click the settings icon and fill in details about the group as required.

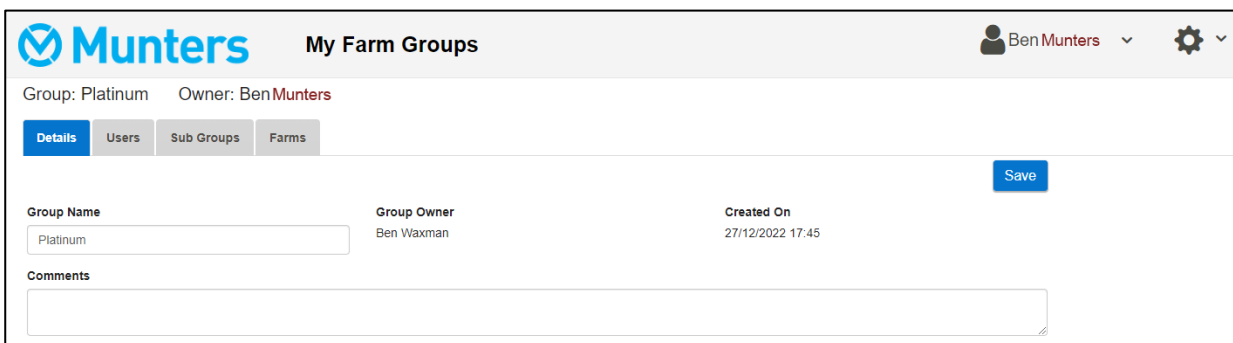

Figure 45: Details Screen

6.2.2 USERS

Click the Users tab to manage all group users.

- Existing Users
- New Users

6.2.2.1 Existing Users

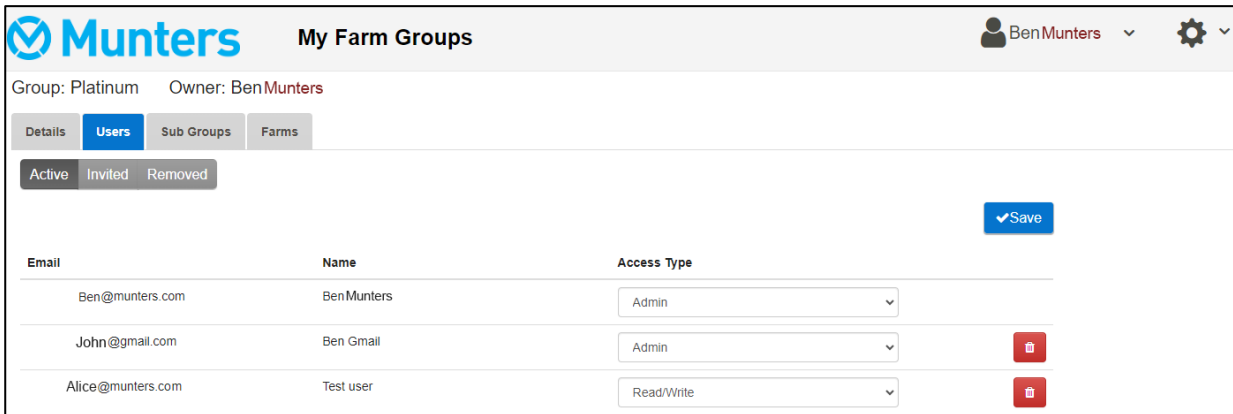

Figure 46: Existing Users Screen

- On this screen, delete users or change the permissions of existing users.

6.2.2.2 New Users

New users who are not part of the system must first sign up before being invited. If the user has an existing email address in the RotemNet Web system, go to Inviting a New User.

6.2.2.2.1 Creating a New User

1. Have the user go to rotemnetweb.com.

ROTEM[®]
RotemNet Web

Selected Region
AMERICA

Language
English

User Email Address
My RotemNetWeb User Email address

Password

Login DEMO

Not registered yet ? [Sign Up Now](#)
[Forgot Password](#)

Figure 47: Sign In Screen

2. Click Sign Up Now.

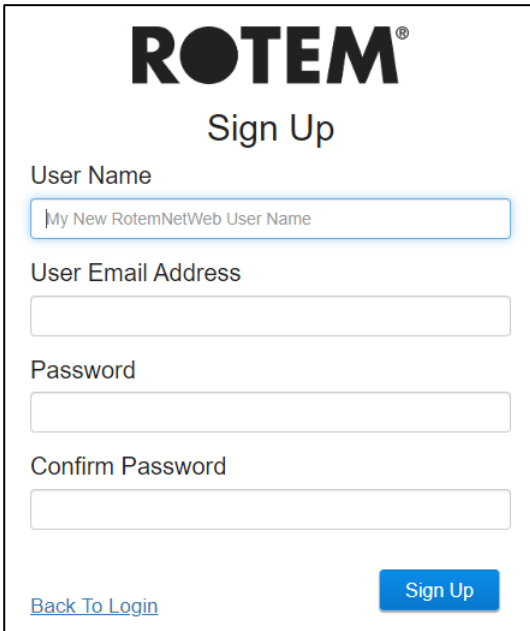

Figure 48: Sign Up Screen

3. Fill in the fields and click Sign Up.

6.2.2.2.2 Inviting a New User

Once the user has created an account, the farm owner goes to the User>Invited screen (only the owner can invite new users).

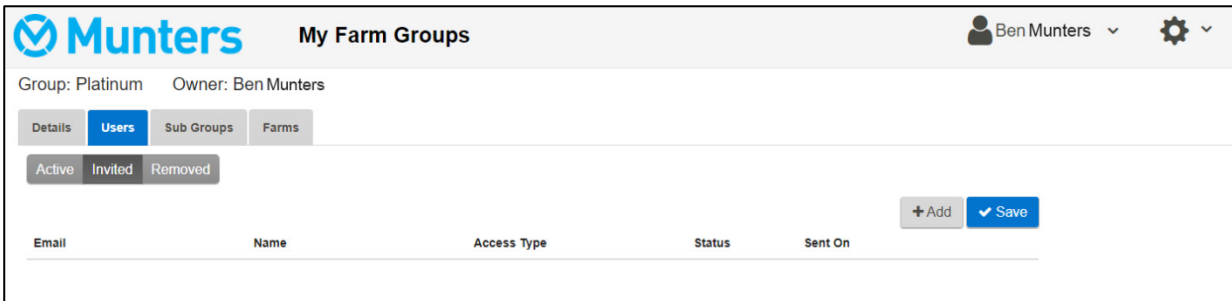

Figure 49: User Screen

1. Click Add.

2. In the Email field, enter the new user's email address. This address must be registered. See the following sections for details on creating a user.

3. Define the Access Type (permissions).

• **CommBox Plus User Rights:**

- ◆ Admin: User can edit all unit parameters including functions related to farm settings and farm ownership.
- ◆ Read/Write: User can edit all unit parameters but cannot perform any functions related to farm settings. (Farm Settings does not appear for users having Read/Write access).
- ◆ Read Only: User can only view the CommBox Plus units' parameters; no changes can be made.

- ◆ Unauthorized: TBD. (Currently used as read only)
- ◆ Support: TBD. (Currently used as read only)
- **Web App User Rights:**
 - ◆ Farm Owner/Admin: User can edit all unit parameters including functions related to farm settings (including attaching a farm to a group) and inviting new users.

NOTE Only an owner can invite new users.

- ◆ Read/Write: User can edit all unit parameters but cannot perform any functions related to farm settings (not visible).
- ◆ Read Only: User can only view the units' parameters; no changes can be made.
- ◆ Unauthorized: TBD. (Currently used as read only)
- ◆ Support: TBD. (Currently used as read only)

4. Click Invite.

The user will receive an email asking him/her to accept the invitation.

6.2.3 FARMS

The Farms screen lists the farms in this group.



Figure 50: List of Farms Screen

6.3 Manage Groups

Manage Groups enables many of the same functions as the My Farm Groups screen. In addition, you can create new groups from this page.

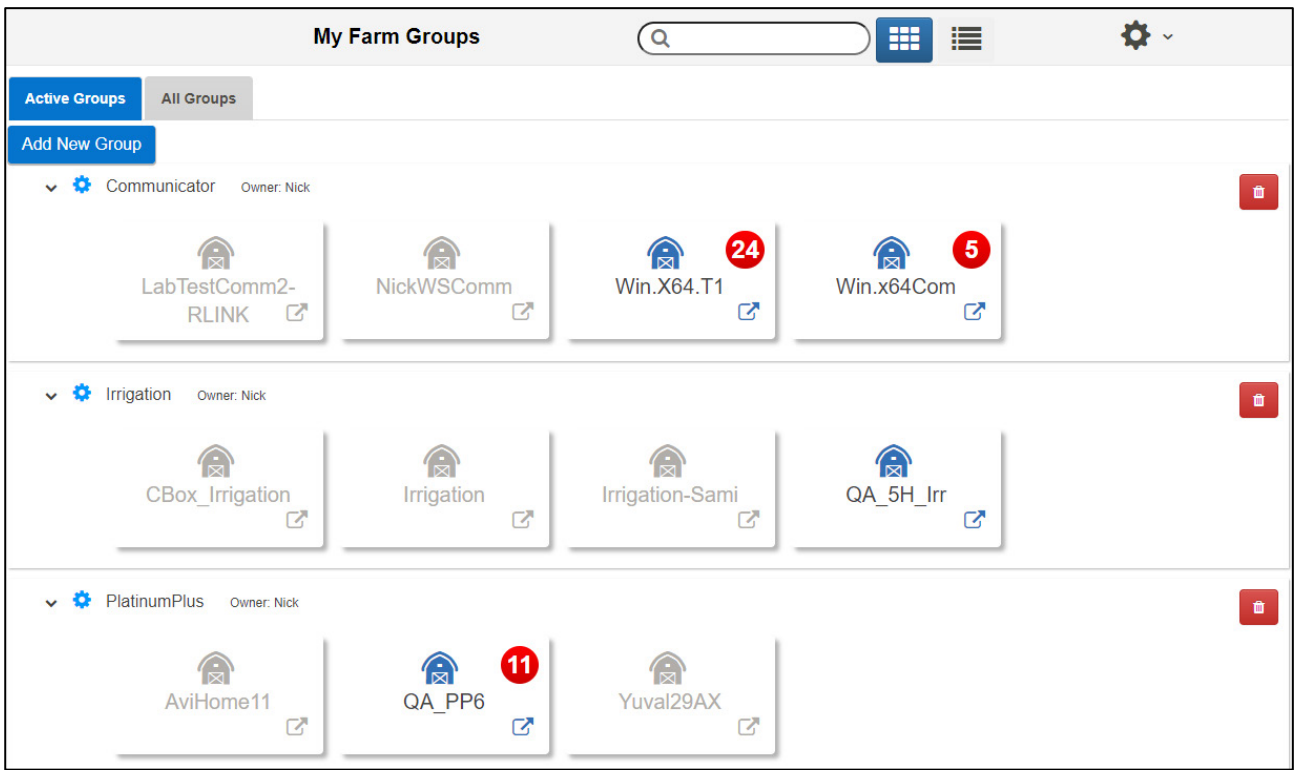

Figure 51: Manage Groups Screen

1. To create a new group, click Add New Group. Fill in the fields.

Figure 52: Add New Group screen

2. After creating the group, add farms to the group. Go to the Farm Settings screen.
NOTE Only a farm owner/administrator connected to a farm locally can attach the farm to a group.

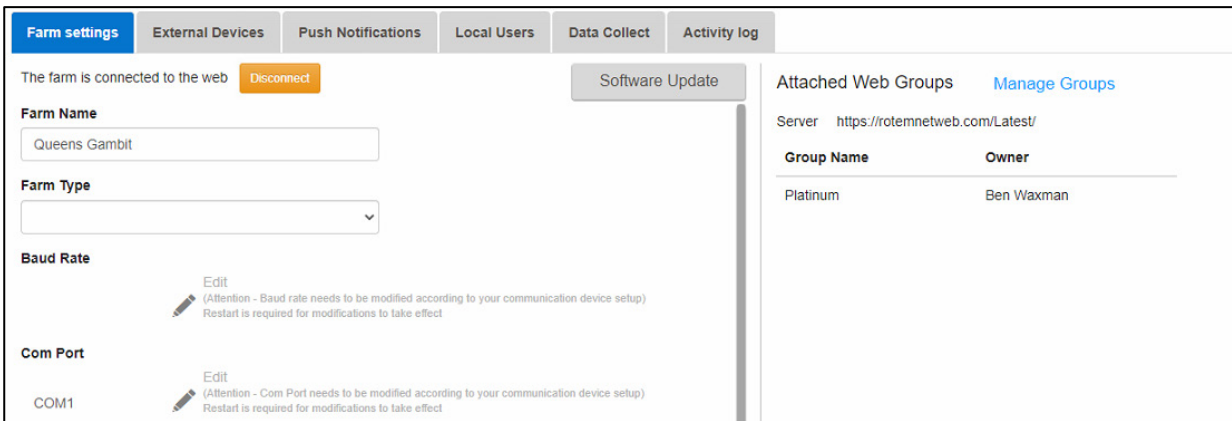



Figure 53: Farm Settings Screen

3. Click Manage Groups and attach the farm to a group (refer to Groups Exist, page 30).

6.4 User Settings

This screen defines how information appears on the screen. In Farm Owner, select

 User Settings. The following screen appears.

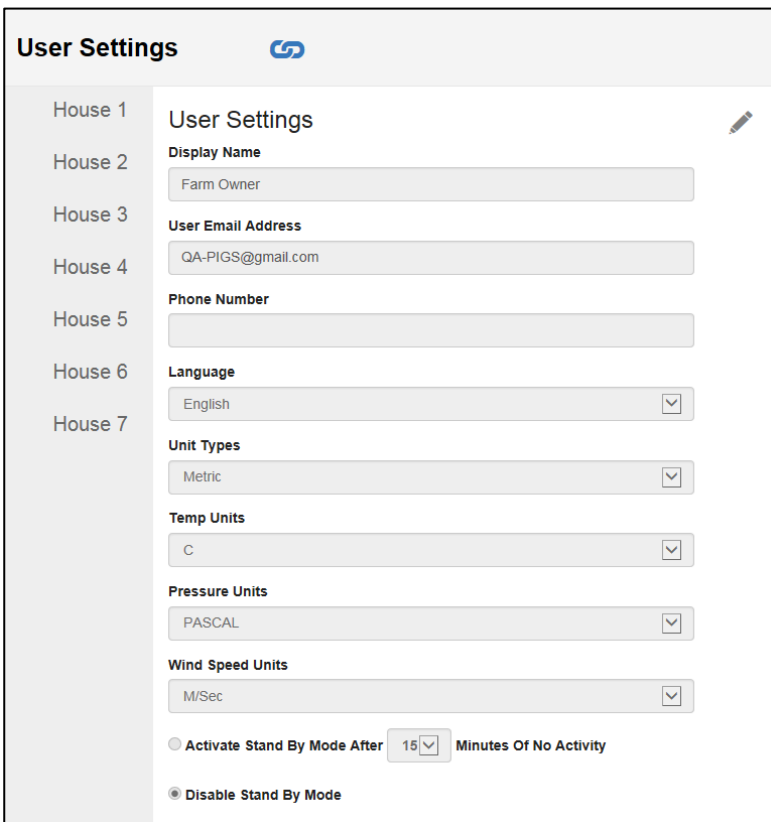



Figure 54: User Settings Screen

- To edit, click . Fill in the following fields as required.
 - Display name: Name that appears on the User Setting screen.
 - User email address

- Phone number
- Language: Chose from the drop-down list
- Unit types: Metric or English
- Temp Units: Celsius or Fahrenheit
- Pressure Units
- Wind Speed Units
- Disable or enable standby by mode (if the latter, define the amount of time that needs to pass before the mode is activated).
- Click  to save any changes.

6.5 RotemNet Farm Management

- Farm Summary and Comparison
- Comparison Screen
- RotemNet Screen Appearance
- RotemNet Web Functionality

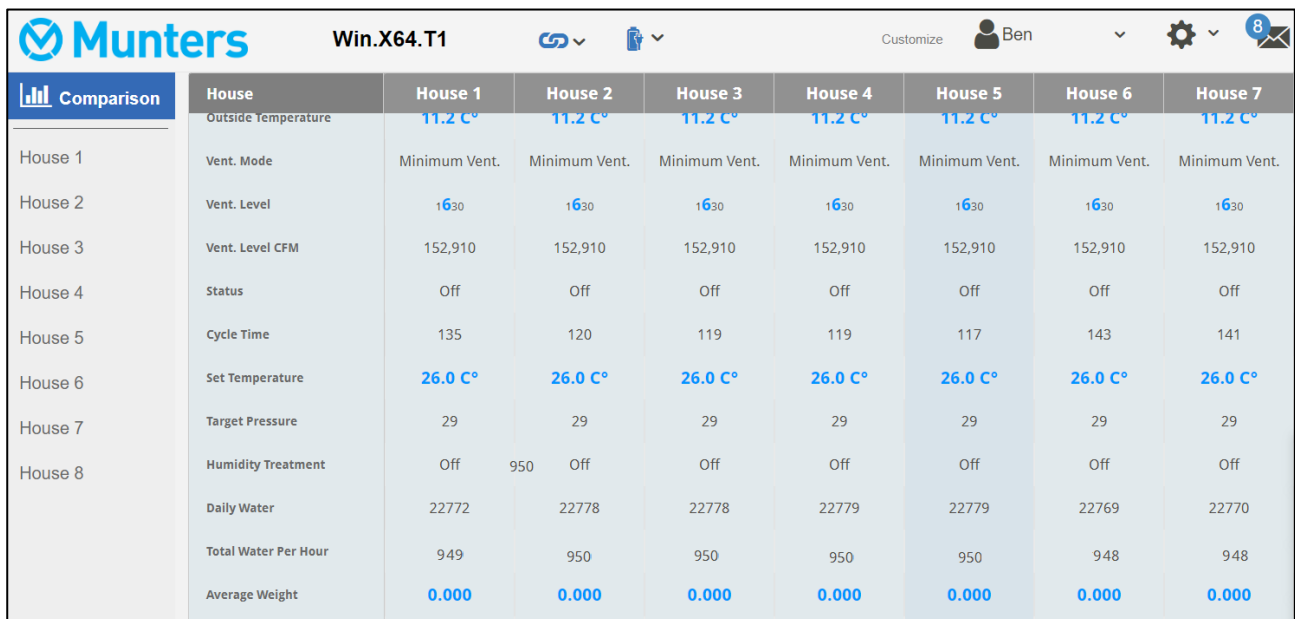

6.5.1 FARM SUMMARY AND COMPARISON

Click Comparison to view a summary of houses' activity.



Munters		Win.X64.T1		Customize		Ben		8	
Comparison	House	House 1	House 2	House 3	House 4	House 5	House 6	House 7	House 7
	Outside Temperature	11.2 C°	11.2 C°	11.2 C°	11.2 C°	11.2 C°	11.2 C°	11.2 C°	11.2 C°
House 1	Vent. Mode	Minimum Vent.	Minimum Vent.	Minimum Vent.	Minimum Vent.	Minimum Vent.	Minimum Vent.	Minimum Vent.	Minimum Vent.
House 2	Vent. Level	1630	1630	1630	1630	1630	1630	1630	1630
House 3	Vent. Level CFM	152,910	152,910	152,910	152,910	152,910	152,910	152,910	152,910
House 4	Status	Off	Off	Off	Off	Off	Off	Off	Off
House 5	Cycle Time	135	120	119	119	117	143	141	141
House 6	Set Temperature	26.0 C°	26.0 C°	26.0 C°	26.0 C°	26.0 C°	26.0 C°	26.0 C°	26.0 C°
House 7	Target Pressure	29	29	29	29	29	29	29	29
House 8	Humidity Treatment	Off	950	Off	Off	Off	Off	Off	Off
	Daily Water	22772	22778	22778	22779	22779	22769	22770	22770
	Total Water Per Hour	949	950	950	950	950	948	948	948
	Average Weight	0.000	0.000	0.000	0.000	0.000	0.000	0.000	0.000

Figure 55: Comparison Houses Screen

- Version 4.7.2.X supports displaying the Total Water Per Hour.
- Click on House to go to the controller functions.
- Click on  to configure RotemNet Web functionality.
- Click on  Farm Owner to configure the user definitions.

6.5.2 COMPARISON SCREEN APPEARANCE

Version 4.7.2.X supports defining the background colors of the Status, Sensors, and Devices sections.

NOTE Only owners/administrators can perform this function.

1. In the settings icon, click Customize.

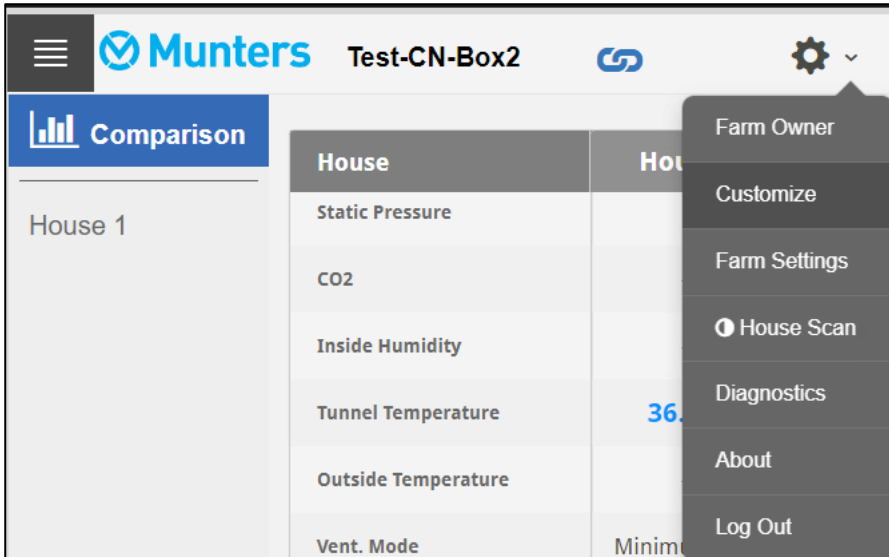

Figure 56: Customize Feature

2. For each section, select the background color.

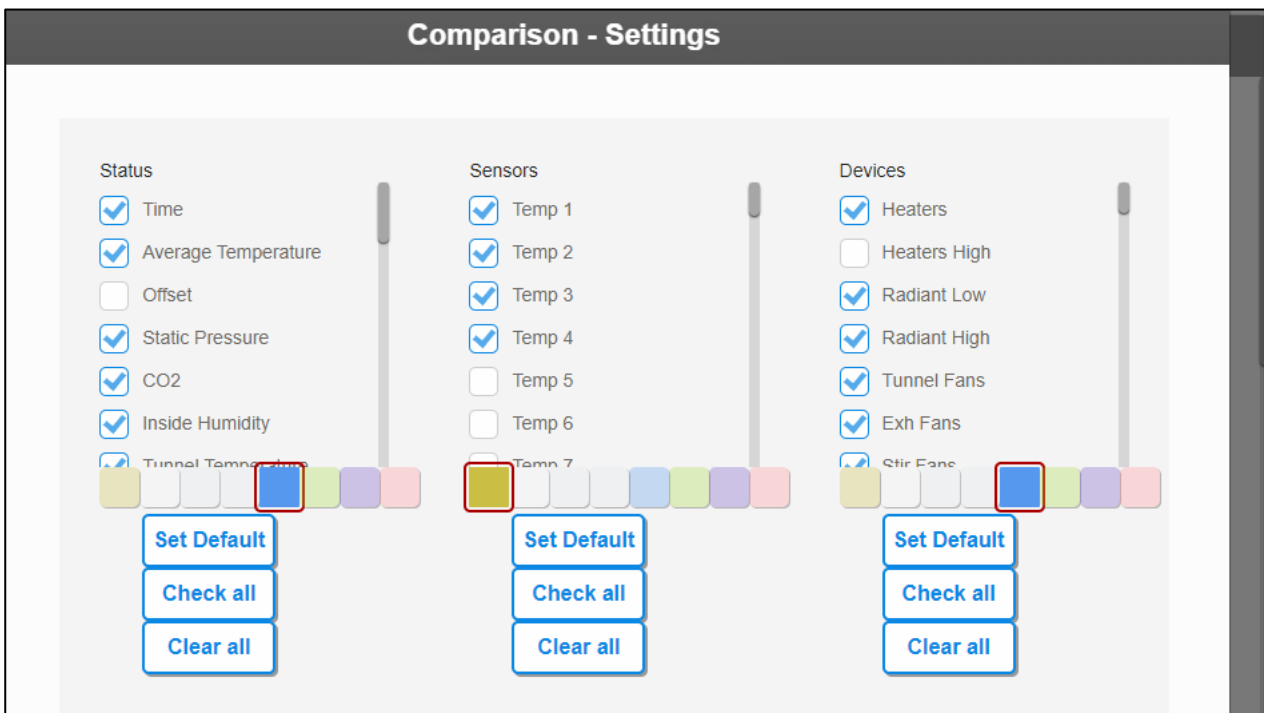

Figure 57: Comparison Settings Screen

3. The screen displays the background colors.

House	House 1
Daily Water	0
Average Weight	0.000
% CFM	9
Temp 1	99.1 C°
Temp 2	21.9 C°
Temp 3	17.5 C°
Temp 4	41.7 C°
Wind Chill	36.1 C°
Heaters	---
Radiant Low	---
Radiant High	---

Figure 58: Color Selection Screen

6.5.3 ROTEMNET SCREEN APPEARANCE

The screen appearance depends on how the user connects to the CommBox Plus, as a local user or via the internet. Users connected locally have access to additional functionality.

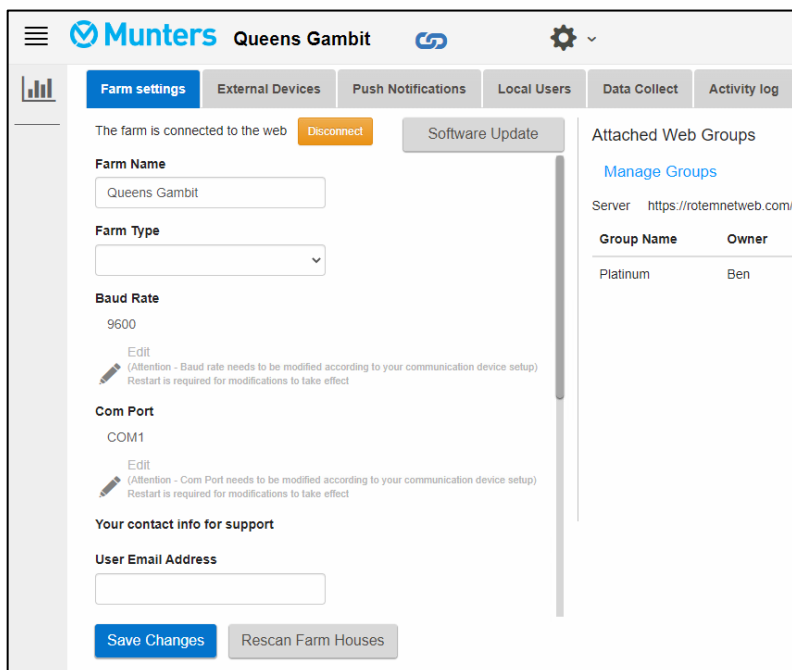

Figure 59: Local Connection

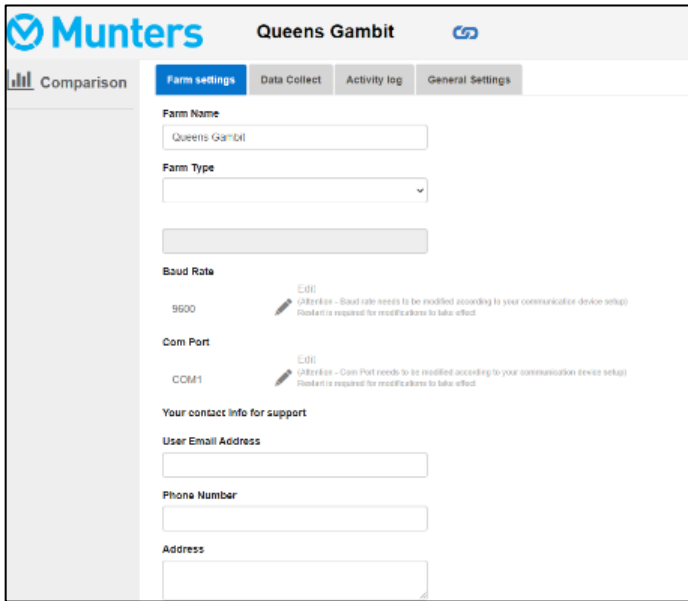

Figure 60: Web Connection

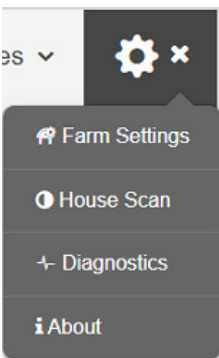

Figure 61: Local Connection Settings

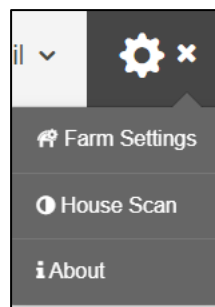

Figure 62: Web Connection Settings (administrator)

In addition, when connected via the web, the user has easy access to his/her groups (Refer to My Farm Groups, page 35).

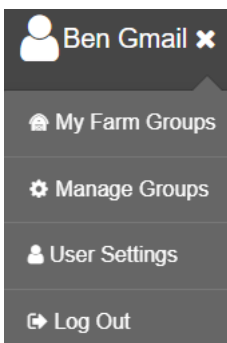
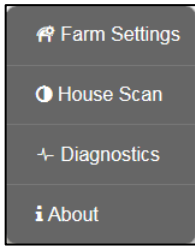

Figure 63: User Group Access

6.5.4 ROTEMNET WEB FUNCTIONALITY

The following section describes the RotemNet Web functions.



- Farm Settings Tab
- House Scan Tab

NOTE Only the farm owner can view the Farm Settings and House Scan tabs.

6.5.4.1 Farm Settings Tab

- Farm Settings
- Push Notifications
- Local Users
- Data Collect
- Activity Log
- General Settings

NOTE The “Local Users” tab appears only on the computer screen connected directly to the CommBox Plus.

6.5.4.1.1 Farm Settings

Use this screen to define functions related to CommBox Plus’s connection to your farm.

- This function appears both for local and web access connections.

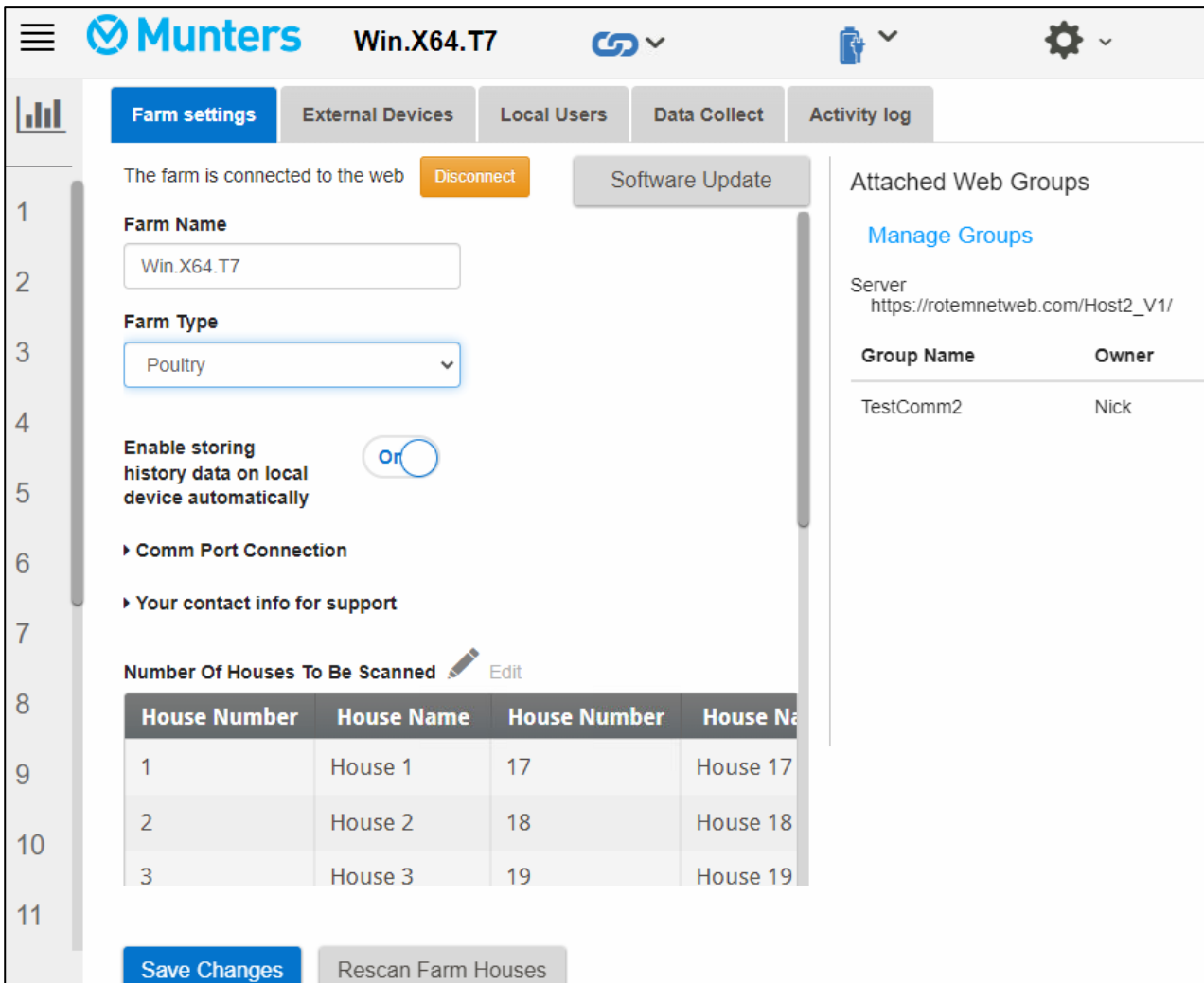

Figure 64: Farm Settings Screen

- **Farm Name:** This is the name that appears on your screen.
- **Connect/Disconnect:** This function enables disconnect from the current farm from the internet and reconnecting it via the Log-in screen (refer to Log In, page 29).

NOTE This function only appears on screens locally connected to the CommBox Plus.

- **Farm Type:** Poultry. Make sure that the definition matches the CommBox Plus type!
- **(Version 4.7.4.19) Enable storing history data on local drive automatically:**
 - When enabled, Comm-Box stores history data automatically in the Comm-Box.
 - When this function is not enabled, data is stored on the controller only when the user views a history page. For example, sensor data is stored when the user views a sensor history screen.
- **Com Port Connections**
 - **Baud rate:** This rate must be the same throughout the network. Munters recommends
 - using the default baud rate, 9600, for wired connections.
 - setting the baud rate at 19200 for RLINK connections.

- **Contact information (optional):** This information will be used by Munters to contact users if there is a need; for example to inform you of an update. The information will not be distributed to any outside parties whatsoever.
- **Number of Houses to be Scanned:** Scanning tests communication to the houses. If you wish to scan all houses or individual houses, click the relevant house number. Click **Rescan farm houses** to complete the scan.
 - You can name the houses.
- Click **Save Changes**.
- **System Update:** Refer to Software Upgrade.

6.5.4.1.2 Push Notifications

CommBox Plus can send push notifications to multiple email addresses. These emails list any current alarms.

- This function appears both for local and web access connections..

Figure 65: Push Notifications Screen

- Enter an address, click Check, Add, and then Save.
 - The CommBox Plus Push Notification system does not provide detailed alarm information. The system is indicative only. To receive real-time alarms along with the ability to configure and manage alarms, contact your dealer about an independent alarms system (for example the Communicator).
 - If a group of alarms are generated simultaneously (for example, Hi Temperature, CO2, and ammonia) only one email (listing all three alarms) is sent. If any of the issues that caused an alarm to be generated is resolved, a new email is sent out listing the current alarms. For example, if the temperature goes down, an email listing CO2 and ammonia alarms is sent).

6.5.4.1.3 Local Users

- This function appears local access connections only.

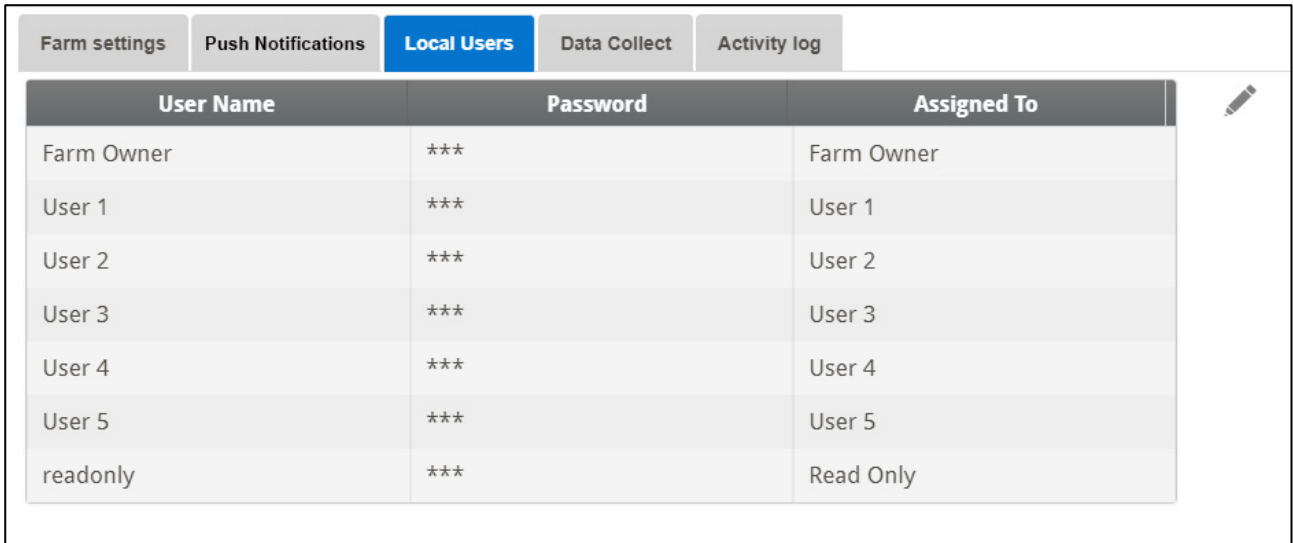

User Name	Password	Assigned To
Farm Owner	***	Farm Owner
User 1	***	User 1
User 2	***	User 2
User 3	***	User 3
User 4	***	User 4
User 5	***	User 5
readonly	***	Read Only

Figure 66: Local Users Screen

This screen lists pre-assigned user names and passwords.

- Username and password are the same. For example, User 1's password is User 1. User 2's password is User 2.
- The Farm Owner can edit these names, passwords, and to whom they are assigned.

6.5.4.1.4 Data Collect

Refer to Appendix B: Data Collection, page 68.

- This function appears both for local and web access connections.

6.5.4.1.5 Activity Log

This screen displays the history of events connected to the CommBox Plus. Under Event, Sub Event, User, and Cmd ID you can select filters to narrow down the results.

- This function appears both for local and web access connections.

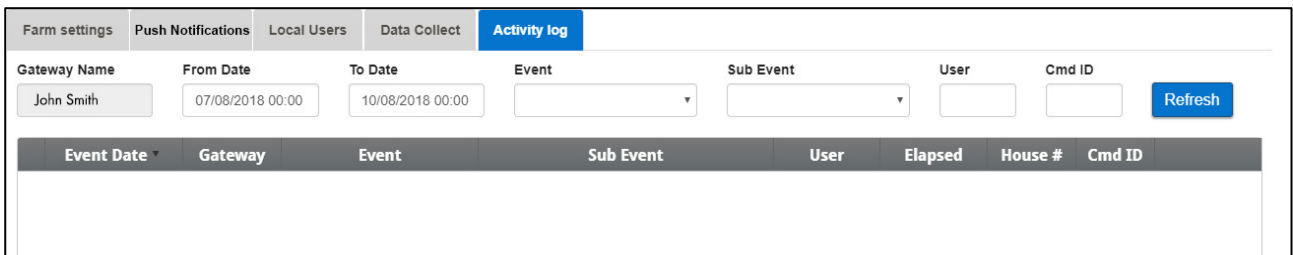

Event Date	Gateway	Event	Sub Event	User	Elapsed	House #	Cmd ID
------------	---------	-------	-----------	------	---------	---------	--------

Figure 67: Activity Log Screen

- Refer to Appendix A: Generating an Activity Log, page 54 for detailed information on this function.

6.5.4.1.6 General Settings

Refer to Appendix B: Data Collection, page 68.

- This function appears in web access connections only.

6.5.4.2 House Scan Tab

- This function appears in both local and web access connections.

The House Scan screen:

- Shows the results of the house scan.
- Show the controller type and version used in each house.

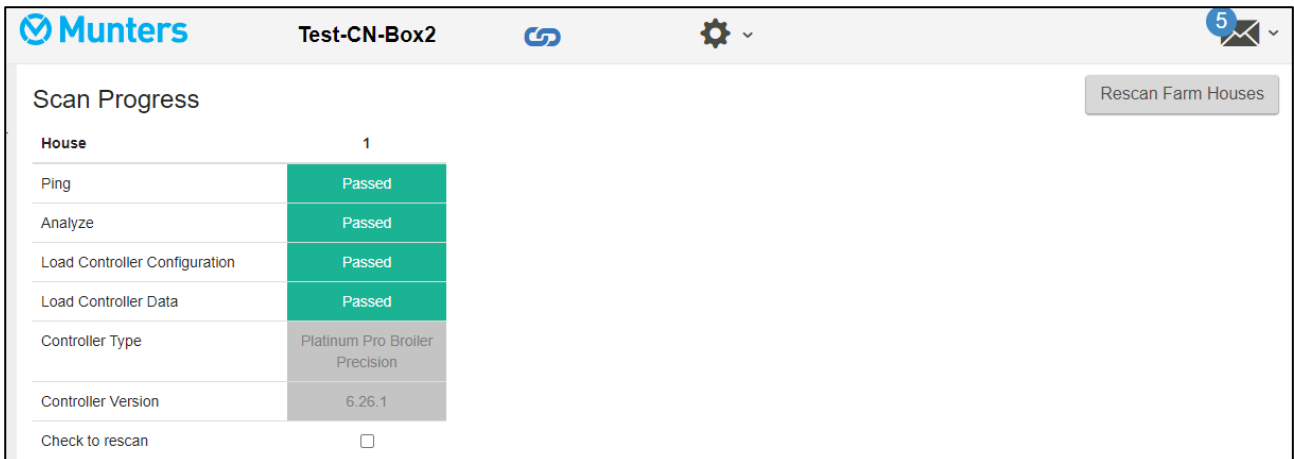

Figure 68: House Scan Screen

6.6 Software Upgrade

- Upgrade Procedure
- User Information

6.6.1 UPGRADE PROCEDURE

- This function appears when connected locally.

You can upgrade certain software programs from the Web application.

- Platinum Touch software
- Web application
- CommBox Plus software

NOTE The CommBox Plus can only be updated locally; it cannot be updated remotely. The System Update button does not appear in remote connections.

NOTE You cannot upgrade product software! Upgrade your product software using the procedures given in the product manuals.

NOTE If you are using a disk on key start here. If you are updating your CommBox Plus via the web, go to step 4.

1. Request the software upgrade from your dealer. You will be sent (via email, web transfer, etc.) a UPD file.
 - a. Place the file on a disk on key/flash drive.
 - b. Place the disk on key/flash drive into the CommBox Plus USB port.
2. In the web application, click the Farm Settings tab. The following screen appears.

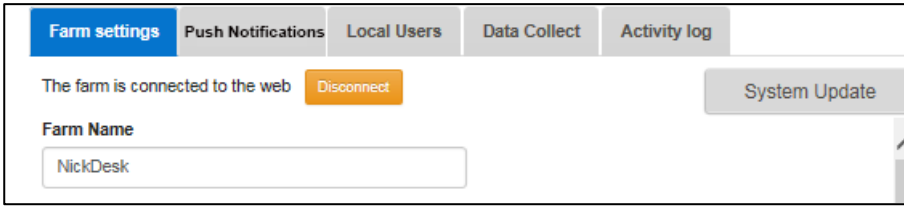

Figure 69: Farm Settings – System Update Button

3. Click System Update. The following screen appears:

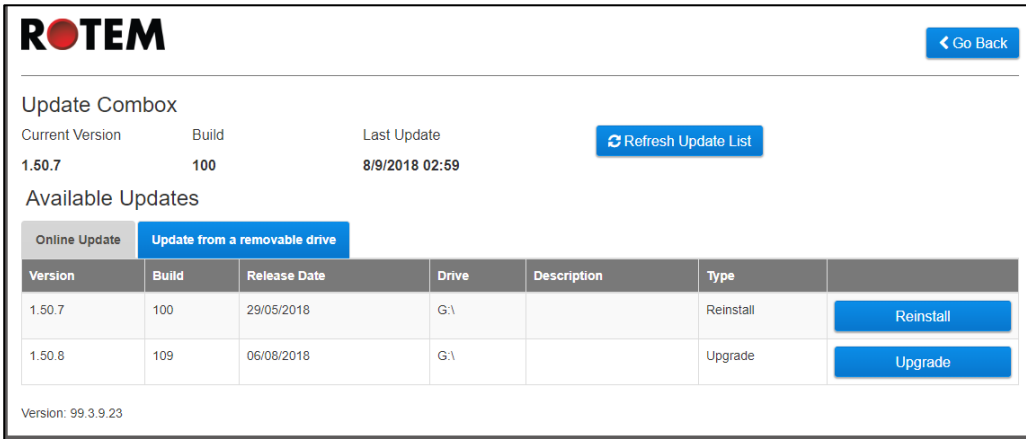

Figure 70: System Update Screen

- Users updating online: Click Online Update and choose the required software version.
- User updating using a flash drive: Click Update from a removable drive and choose the required software version.

NOTE If you did not place the disk on key in the USB port or if the disk does not contain a program, an error message appears.

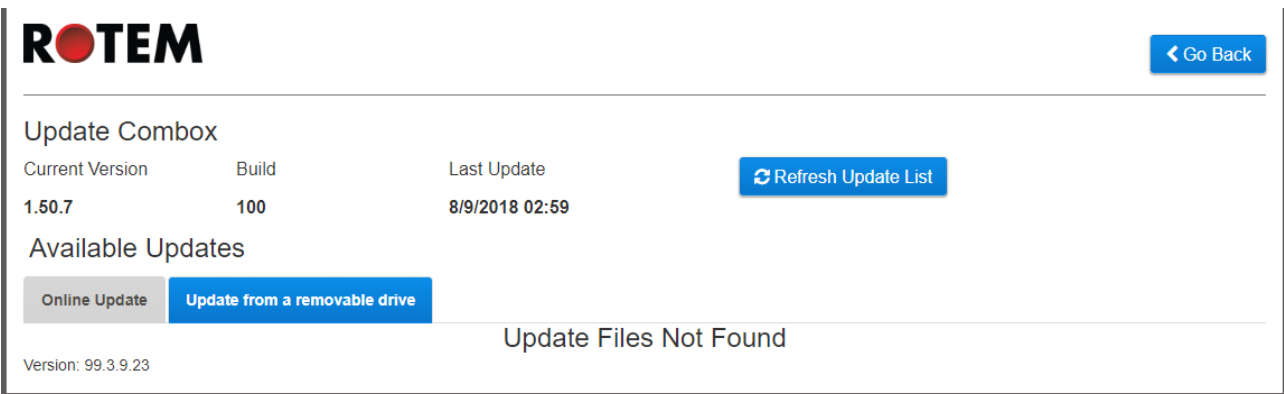
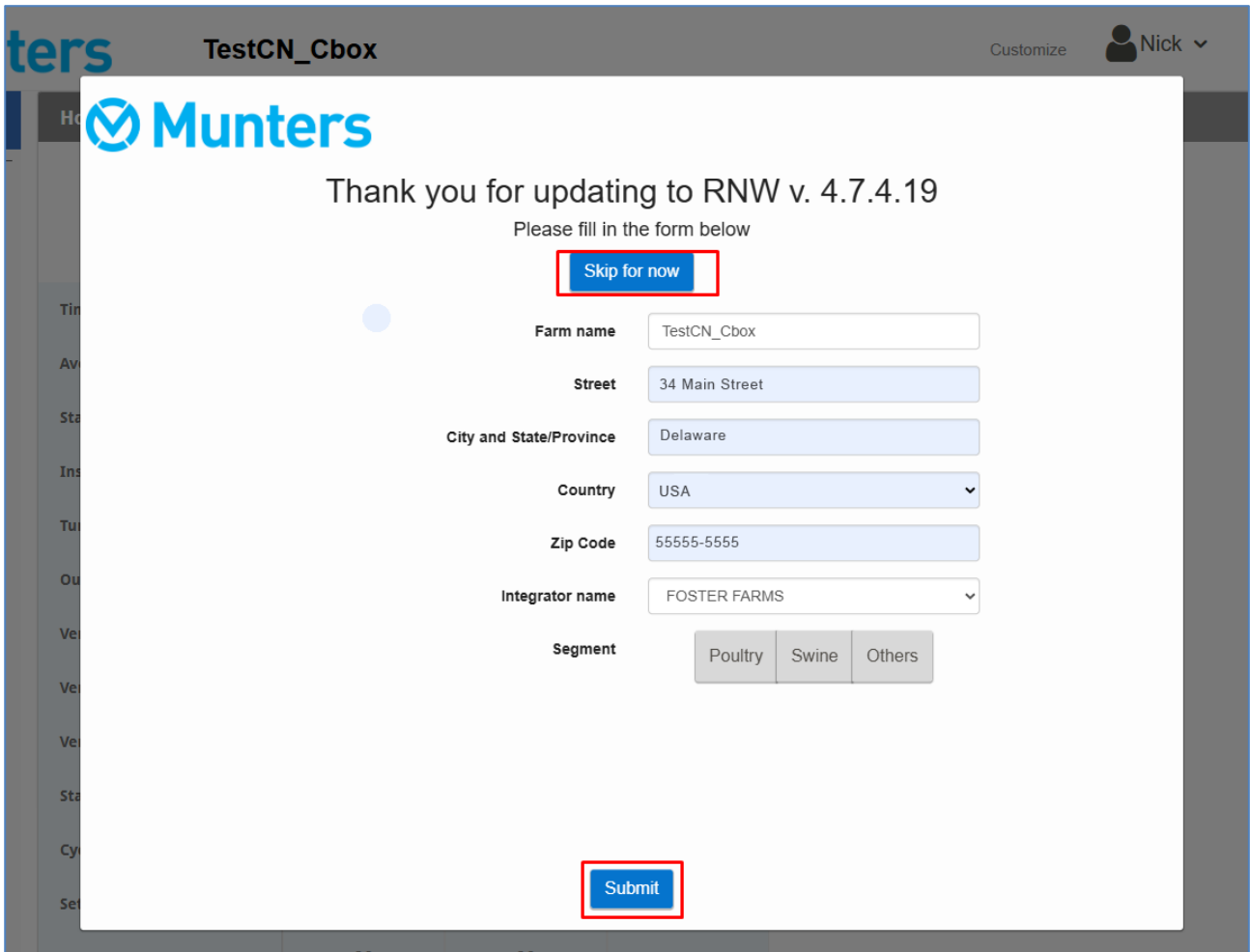

Figure 71: System Update Error

6.6.2 USER INFORMATION

When updating to Version 4.7.4.19, the user is requested (three times) to fill out the following form. This information enables Munters to provide an improved user experience. Please note that this information will not be shared with any outside body.



The screenshot shows a user interface for Munters. At the top, there is a header with the Munters logo, the text 'TestCN_Cbox', and a 'Customize' button next to a user profile icon labeled 'Nick'. A modal window is displayed in the center, featuring the Munters logo and the message 'Thank you for updating to RNW v. 4.7.4.19'. Below the message, it says 'Please fill in the form below'. A blue button labeled 'Skip for now' is positioned above the form fields. The form consists of several input fields: 'Farm name' (TestCN_Cbox), 'Street' (34 Main Street), 'City and State/Province' (Delaware), 'Country' (USA), 'Zip Code' (55555-5555), and 'Integrator name' (FOSTER FARMS). Below these fields is a 'Segment' section with three buttons: 'Poultry', 'Swine', and 'Others'. At the bottom of the modal, there is a blue 'Submit' button.

Figure 72: User Information Screen

6.7 About Tab

This screen displays the product and software version. Send this information to technical support in the event that you require assistance. The Support ID enables remote technical support from Munters or from your dealer.

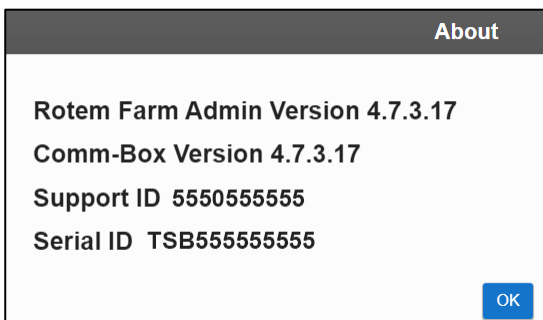

The screenshot shows a dialog box titled 'About'. It contains the following text: 'Rotem Farm Admin Version 4.7.3.17', 'Comm-Box Version 4.7.3.17', 'Support ID 5550555555', and 'Serial ID TSB55555555'. A blue 'OK' button is located at the bottom right of the dialog box.

Figure 73: About Screen

7 Diagnostics

CommBox Plus 4.6.0.35 includes a basic diagnostics package.

- This function appears in local access connections only.

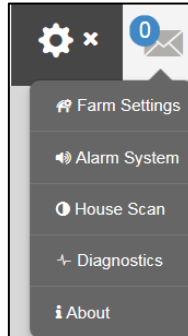

Figure 74: Diagnostics Selection

- On the Settings screen click Diagnostics. The following screen appears.

Serial Number	Version
TSBG07009328 <input checked="" type="checkbox"/>	1.50.8.46035

Diagnostic Tests

Test Name	Test Instruction	Com 1 Connection	House Number	Repeatable	Run Test	Pass	Fail
Comm Port Connection	<ul style="list-style-type: none"> • Connect Serial RS232 Cable From Controller To Comm Port 1 At The Comm-Box. • Go To Communication Menu (Under Install Menu On PP Controller System in Touch Controller). • Set The House Number to 1 and Baud Rate To 9600. • Press the Run Test Button. • Repeat Steps 1 to 4 for Comm Port 2 	9600	1	<input type="checkbox"/>	Run Test		
Internet Connection	<ul style="list-style-type: none"> • On the Comm-Box, connect the LAN cable to LAN Port 1. • Click Run Test. • Repeat for LAN Port 2. 				Run Test		
Connection To Rotem WEB System	<ul style="list-style-type: none"> • On the Comm-Box, connect the LAN cable to one of the LAN ports. • Click Run Test. 				Run Test		
Latest Image Version Installed	<ul style="list-style-type: none"> • This test verifies that the last released image is installed in this Comm-Box • This test is performed automatically 				Run Test		
TeamViewerID for the Remote Support	<ul style="list-style-type: none"> • On the Comm-Box, connect the LAN cable to one of the LAN ports. • Click Run Test." 				Run Test		

Figure 75: Diagnostic Tests

CAUTION When switching from Diagnostics mode to Normal mode, there could be a System Issue with closing communication port. If there is a service interruption, reboot the CommBox Plus.

- Use this screen and the information it supplies when speaking with technical support.
- Diagnostic Tests enables the following tests:
 - Lan test
 - Internet tests
 - Support tests
 - COM Port test. This option can be used to test the communication between the CommBox Plus and any house. Enter the number of the house to be tested. This test has two options:
 - Standard. This test shows the ping time between the CommBox Plus and the selected controller. Either a number appears or there is a failure.

Test Name	Test Instruction			Pass	Fail
Comm Port Connection	<ul style="list-style-type: none"> • Connect Serial RS232 Cable From Controller To Comm Port 1 At The Comm-Box. • Go To Communication Menu (Under Install Menu On PP Controller System in Touch Controller). • Set The House Number to 1 and Baud Rate To 9600. • Press the Run Test Button. • Repeat Steps 1 to 4 for Comm Port 2 	Com4 Connection <input type="text" value="9600"/> House Number <input type="text" value="1"/> <input type="checkbox"/> Repeatable	Run Test	✓ 1.2609012	

Figure 76: Standard Tests

- Repeatable. This test enables verifying that the controller’s communication card (RS232 or RS485) is sending and receiving signals. Click the Run Test icon and examine the controller communication card to ensure that its test LEDs are flashing.

Test Name	Test Instruction			Pass	Fail
Comm Port Connection	<ul style="list-style-type: none"> • Connect Serial RS232 Cable From Controller To Comm Port 1 At The Comm-Box. • Go To Communication Menu (Under Install Menu On PP Controller System in Touch Controller). • Set The House Number to 1 and Baud Rate To 9600. • Press the Run Test Button. • Repeat Steps 1 to 4 for Comm Port 2 	Com4 Connection <input type="text" value="9600"/> House Number <input type="text" value="1"/> <input checked="" type="checkbox"/> Repeatable	Run Test	✓ 27.481028	

Figure 77: Repeatable Tests

- Enables a speed test.

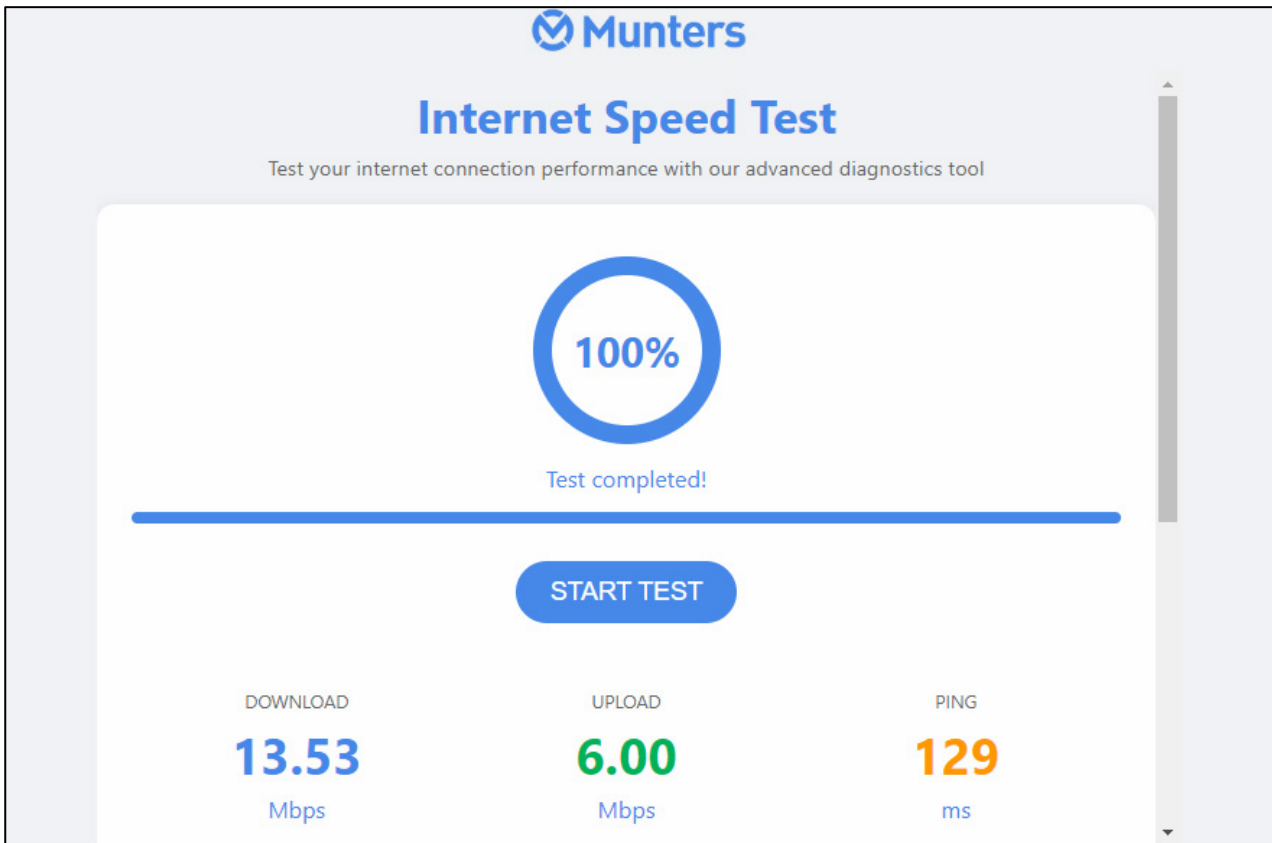

Figure 78: Speed Test (Results, example)

CAUTION A 5 Mbps upload/download speed (minimum) is required to ensure secure connectivity between the Comm-Box Plus and controllers.

8 Controller Functionality

CommBox Plus Version 4.7.2.X enables controllers additional functionality that is not found when using the keyboard or touch screen.

- Modal
- Bird Inventory
- Growth Day Send to All

8.1 Modal

CommBox Plus Version 4.7.2.10 supports Modal functionality in Platinum Pro/Platinum Touch/Rotem Pro/Rotem One controllers. Modal enables defining the differential temperature in Levels of Ventilation in a range of ventilation levels. The differential level triggers the next level of ventilation according to difference from target temperature (time delays remain in effect).

NOTE Modal only is available when a user is connected to a controller via a CommBox Plus or via the web. It is not available when managing the controller locally.

➤ In Platinum System > Relays or System > Analog Output, define exhaust fans and tunnel fans as required.

1. Go to System > Levels of Ventilation.

Levels Of Ventilation									
Exhaust & Tunnel Fans									
Vent & Curtain									
Variable Speed Fans									
Stir & Variable Stir Fans									
Level	On (Sec.)	Air Capacity	Diff.	Tunnel Level	Exhaust		Tunnel		
					E1	E2	T1	T2	
1	0	0	0.0	<input type="checkbox"/>	X	X	X	X	
2	0	0	0.0	<input type="checkbox"/>	X	X	X	X	
3	0	0	0.0	<input type="checkbox"/>	X	X	X	X	
4	0	0	0.0	<input type="checkbox"/>	X	X	X	X	
5	0	0	0.0	<input checked="" type="checkbox"/>	X	X	X	X	
6	0	0	0.0	<input type="checkbox"/>	X	X	X	X	

Figure 79: Level of Ventilation Screen

2. Define the On time and the exhaust/tunnels as required (refer to the controller manuals for details). Note: Air Capacity is read-only.

Levels Of Ventilation								
Exhaust & Tunnel Fans			Vent & Curtain	Variable Speed Fans	Stir & Variable Stir Fans			
Level	On (Sec.)	Air Capacity	Diff.	Tunnel Level	Exhaust		Tunnel	
					E1	E2	T1	T2
1	30	2,039	0.0	<input type="checkbox"/>	<input checked="" type="radio"/>	X	X	X
2	45	3,058	0.0	<input type="checkbox"/>	<input checked="" type="radio"/>	X	X	X
3	60	4,078	0.0	<input type="checkbox"/>	<input checked="" type="radio"/>	X	X	X
4	30	6,626	0.0	<input type="checkbox"/>	<input checked="" type="radio"/>	X	X	<input checked="" type="radio"/>
5	45	9,939	0.0	<input type="checkbox"/>	<input checked="" type="radio"/>	X	X	<input checked="" type="radio"/>
6	60	13,253	0.0	<input type="checkbox"/>	<input checked="" type="radio"/>	X	X	<input checked="" type="radio"/>
7	0	0	0.0	<input type="checkbox"/>	X	X	X	X

Figure 80: Level of Ventilation Screen (2)

3. Click the edit icon . The Set Level of Ventilation screen appears.

Set Level of Ventilation

From Level

To Level

Change

Figure 81: Set Level of Ventilation Pop-up

4. Define the levels at which the differential is changed and the differential. Note: The first several levels normally have differential temperatures set to 0.

Set Level of Ventilation

From Level
4

To Level
6

Change
2

Set Changes Cancel

Figure 82: Set Ventilation Screen Defined (example)

The changes appear on the Levels of Ventilation screen.

Levels Of Ventilation

Exhaust & Tunnel Fans Vent & Curtain Variable Speed Fans Stir & Variable Stir Fans

Level	On (Sec.)	Air Capacity	Diff.	Tunnel Level	Exhaust		Tunnel	
					E1	E2	T1	T2
1	30	2,039	0.0	<input type="checkbox"/>	●	X	X	X
2	45	3,058	0.0	<input type="checkbox"/>	●	X	X	X
3	60	4,078	0.0	<input type="checkbox"/>	●	X	X	X
4	30	6,626	2.0	<input type="checkbox"/>	●	X	●	X
5	45	9,939	2.0	<input type="checkbox"/>	●	X	●	X
6	60	13,253	2.0	<input type="checkbox"/>	●	X	●	X
7	0	0	0.0	<input type="checkbox"/>	X	X	X	X

Figure 83: Levels of Ventilation Screen (3)

At levels 4, 5, and 6 ventilation goes to the next level when the temperature is 2 degrees about the tunnel or target temperature (depending on if the level is below or above the tunnel level. Refer to the Platinum manuals for details).

8.2 Bird Inventory

When defining the bird inventory via CommBox Plus, Platinum Pro/Rotem One support up to 140,000 birds (the controllers support up to 99,999 birds when defining this function using the keyboard).

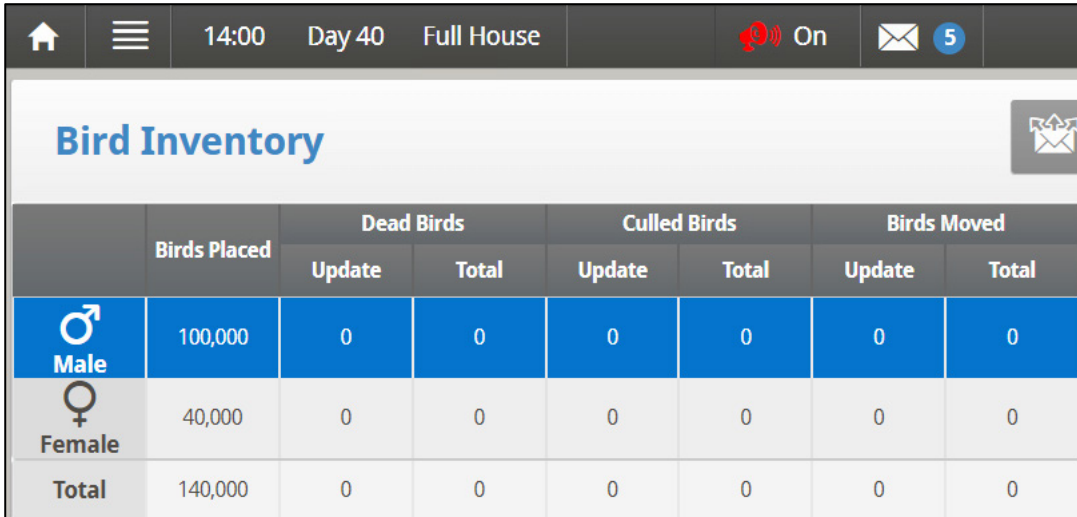

	Birds Placed	Dead Birds		Culled Birds		Birds Moved	
		Update	Total	Update	Total	Update	Total
♂ Male	100,000	0	0	0	0	0	0
♀ Female	40,000	0	0	0	0	0	0
Total	140,000	0	0	0	0	0	0

Figure 84: Bird Inventory Screen

8.3 Growth Day Send to All

Version 4.7.2.X enables changing the growth day in selected houses.

1. Go to Management > Growth Day & Flock.

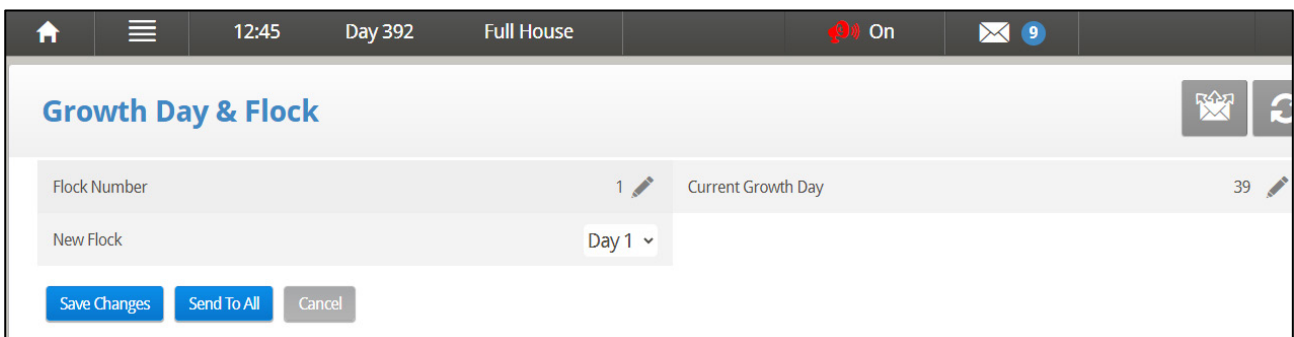

Flock Number: 1 Current Growth Day: 39

New Flock: Day 1

Figure 85: Growth Day & Flock Screen

2. Edit as required and click **Send to All**.

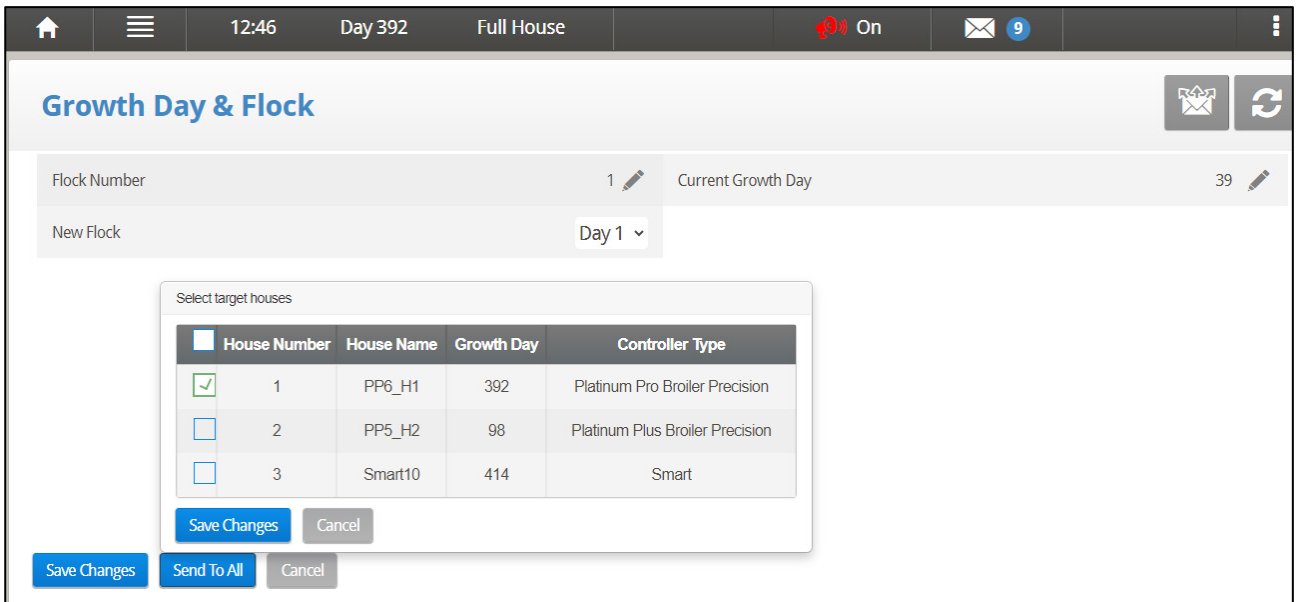

Figure 86: Send to All Function

3. Select the houses in which the change applies and click Save Changes.

9 Appendix A: Generating an Activity Log

The following section details how to use the Activity Log, in particular how to determine who made changes to the controllers' settings. Please note:

- These inquiries can only be made via the web. Local connections or connecting via TeamViewer do not support this function.
- Only changes made via the web are listed! Changes made locally by the farm owner or administrator are not listed.
- Only administrators can perform this function.

1. Connect to a farm via www.rotetnetweb.com.

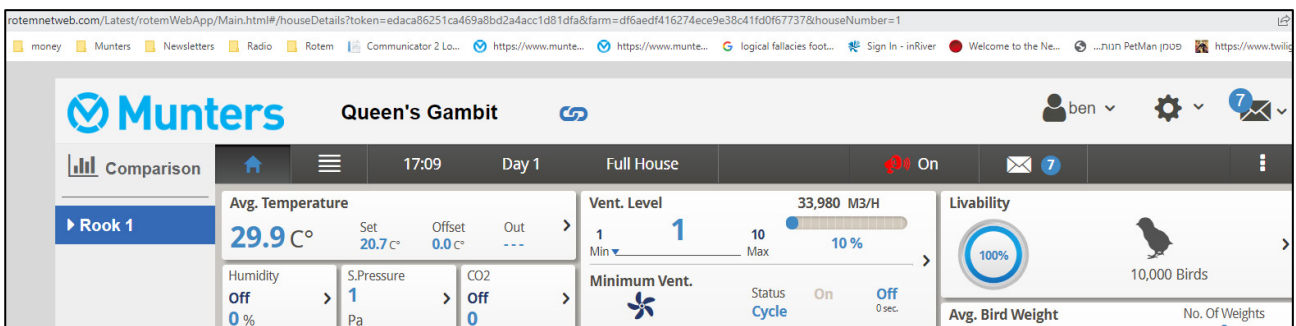
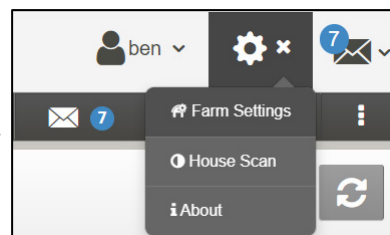

Figure 87: Rotem Net Web Homepage

2. Under the settings icon, click Farm Settings.



3. Click the Activity Log tab.

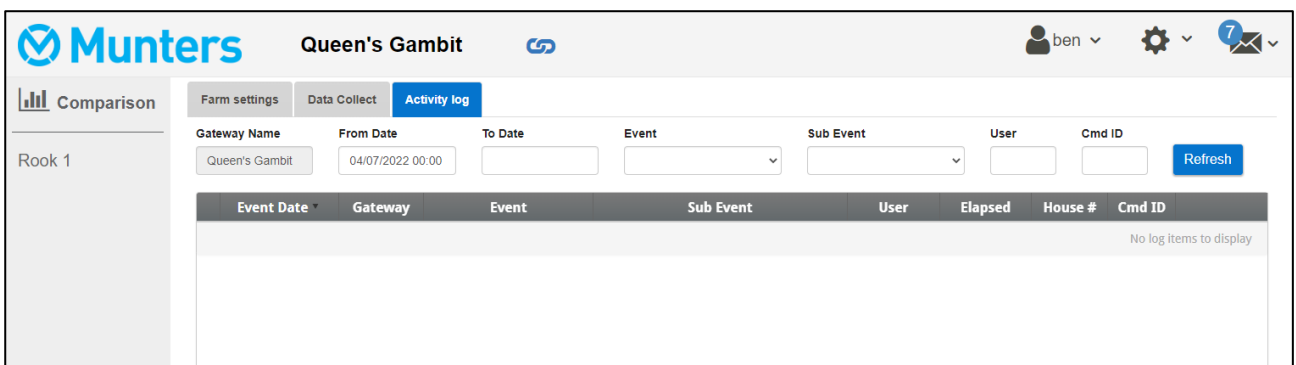

Figure 88: Activity Log Screen

4. Define as needed:

- Gateway Name: (farm name that the user chose): Read only.
- From/To: Define the time frame.
- Event:
 - To see all events, leave this field empty.
 - To see who made changes to the controller settings, choose **Save Farm Data** from the dropdown list.
- Sub Event: Select if required.
- User: If you are looking for a specific person's activities, type in the user name.
- Cmd ID: If you are looking for a specific change in controller settings, type in the command ID. See the list in the following table.

In the following example Event is defined as **Save Farm Data**. User **ben** made the following changes:

Farm settings		Data Collect		Activity log				
Gateway Name	From Date	To Date	Event	Sub Event	User	Cmd ID		
Queen's Gambit	04/07/2022 00:00		Save Farm Data					Refresh
Event Date	Gateway	Event	Sub Event	User	Elapsed	House #	Cmd ID	
04/07/22 16:09:59	Queen's Gambit	Save Farm Data	Web Request Ended	ben	263 ms	1	85	show info
04/07/22 16:09:52	Queen's Gambit	Save Farm Data	Web Request Ended	ben	250 ms	1	85	show info
04/07/22 16:09:32	Queen's Gambit	Save Farm Data	Web Request Ended	ben	250 ms	1	85	show info
04/07/22 16:08:01	Queen's Gambit	Save Farm Data	Web Request Ended	ben	2.823 sec	1	66	show info
04/07/22 16:07:35	Queen's Gambit	Save Farm Data	Web Request Ended	ben	1.776 sec	1	21	show info
04/07/22 16:06:29	Queen's Gambit	Save Farm Data	Web Request Ended	ben	1.263 sec	1	27	show info
04/07/22 15:43:37	Queen's Gambit	Save Farm Data	Web Request Ended	ben	3.366 sec	1	11	show info

Figure 89: Activity Results (example)

- 85: History feed
- 66: Fan air capacity
- 21: Event DB Property
- 27: Temp & Timer Setting
- 11: VOID (Reserved)

CMD IDs and Description		
1: Version Old	3: VOID	4: Signature
7: Active Alarm	9: VOID	11: VOID
12: Bird Inventory - READ	13: VOID	14: VOID
15: VOID	17: CO2 Treatment STD	18: VOID
19: Dosing Pump	20: PCI	21: Event DB Property

CMD IDs and Description		
23: VOID	24: Ammonia Treatment STD	25: Relay Current
27: Temp & Timer Setting	28: STD	29: VOID
30: Stir Fan Level	31: VOID	32: VOID
33: VOID	34: VOID	35: VOID
36: VOID	37: VOID	38: Light Feed
39: Water and Feed	40: Extra System	41: Static Pressure Standard
42: Static Pressure Precision	43: Control Mode	44: Bird Curve
45: History Setup	46: Levels Of Ventilation	47: Feed Calibration
48: Water Calibration	49: Setup	50: Relays Layout
51: Analog Sensors	52: Digital Sensors	53: Temp Definition
54: Curtains Setup	55: Vent And Curtain Level	56: Sys CO2 Treatment STD
57: System Parameters	58: Bird Scale Setting Bre As Bro	59: Alarm Settings
60: Sys Ammonia Treatment STD 9	61: Stir Fan Program	62: VOID
63: VOID	64: Analog Output	65: Temperature Reminder
66: Fan Air Capacity	67: VOID	68: Speed Fan Levels
69: Feed Bin Settings	70: Data Plug	72: Relays Test
73: VOID	74: Daily DB Property	75: Cage
76: EggRoomSetPoint	77: VOID	78: VOID
81: Sys Nest	83: History Temperature	84: History Humidity
85: History Feed	87: History Alarms	88: SSC Plug Play
90: Sys_ControlMode	92: Week Of Flock	93: Time
94: VOID	96: SRP HUB HW	97: Feed Inventory
98: Last 100 Weights	99: Set THI	101: Temp Curve
102: Set Rad Heater	103: Vent Level Set Point	104: Set stir fan

CMD IDs and Description		
105: Static Pressure Set Point	106: Set Cool Pad	107: Set Point Foggers
108: Set Humidity Treatment	109: Set Soft Min/Max Level	110: VentAndCurtainLevels Set Point
111: Light Set parameters	112: Active Silo	113: Emergency Set Point
114: VOID	115: Sys Minimum Vent	116: Set Relay Current
117: Bird Inventory - WRITE	118: VOID	119: Alarm DB Property
120: RDT Table	122: Test Analog Input	123: Test Digital
124: VOID	125: RDT Set Table	126: SSC HD
127: Het Key - Temperature Sensors	128: FeedQuantityUpdate	130: VOID
131: VOID	132: VOID	133: VOID
134: CO2 Set Point	135: Sys Water and Feed	137: VOID
138: VOID	139: VOID	140: VOID
141: History System Events	142: Set Bird Scale Setting BreAsBro	143: WorkRoomControl
144: EggRoom	145: VOID	146: CO2 Treatment
147: Feed Conversion	148: SRP Hub Plug And Play	149: Light No Feed
150: History View DB Property	151: New History View	152: Set Dosing Pump
153: Levels Of Ventilation - Read Only	154: Min/Max Level By Weight	155: Set Point of Min/Max Level By Weight
156: Set Point Scale Layout	157: MinVent & Ramping Set point	158: Fogger Set Point (STD)
159: Fogger STD	160: Variable Speed Fans Setting	162: STD Curtain Set up
163: set.Std_V_Speed_Fans	164: Stir Fan Set program	165: Water On Demand
166: Sys variable heat	194: Feed Scale Program	206: Light No Feed
207: Light Feed	208: Water And Feed	215: Auger Layout

CMD IDs and Description		
216: Water And Feed By Quantity from 5.05	217: Water And Feed By Quantity	218: Set Curve
222: Set Natural Program	224: Natural Program	225: Ammonia Treatment
228: Service Wind Direction	231: Ammonia Treatment SetPoint	235: Feed Line Calibration
236: Set Floor Heat	237: Light Dimmer Comm	238: Water and Feed SetPoint
239: Set Water On Demand	243: Minimum Vent Timer STD	244: Timer Settings STD
247: Temp And Timer Settings STD	248: Sys Humidity TreatmentSTD	249: Sys Curtain Calibration
255: Hot Key Natural	256: Hot Key - Lights	257: Munters Drive
258: Water Meters	260: Web OverView	261: Dash Board
262: Switches Change Confirm	263: Switch Status Array	264: Status Bar
265: Temp Reminder	266: System Security	267: Signatures
270: ReciveOnce	271: EggRoomHistory	272: HK EggRoom
273: HumidityFactorComm	274: WaterAndFeedBreeder	276: History Egg Belt
277: Fast Main Screen	278: Hot Key - Water & Feed	279: History Egg Counter
280: HK Egg Counter	284: History Ammonia	285: Hot Key - Analog Output
286: SetPoint Feed Scale	287: HK Feed Scale	288: Scale Clibration
290: Scale Layout	291: Emergency Set Comm	293: Hot Key - Scales
294: Set Analog Output	295: Feed Scale Program	296: Hot Key Feed Bin
298: Feed Scale Setting	299: HK_FeedScale	300: Hot Key - Temperature & Humidity
301: Hot Key - Curve	302: Water and Feed Set Mem23	303: Hotkey Zoon Inlet
304: Hot Key - Infra Red	305: VOID	306: Nest table

CMD IDs and Description		
307: Hot Key - Curtains	308: Bird Weight Bre As Bro	309: Scale History Bre
311: Bird Weight Bre Auto	312: Web Weight	313: Control Level By Weight Hot Key
314: Scale Test	315: FDQ Tab 1	318: HK Pump Dosing
319: TableWarning	320: Heather Duration	321: Power Consumption
322: History Heaters	323: History Mortality	324: History Water
325: SSC Power Consumption	326: SSC HK	327: FDQ Tab 2
328: History Variable Heaters	329: Hot Key Cool Ramping	330: Dosing Pump
331: Dosing Pump History	332: History Table Of Events	333: History Radiant Heaters
334: Power Meter HK	335: Munters Drive HK	336: Scale History
337: CO2 History	338: SRP Hub	

10 Appendix B: Data Collection

10.1 Centralized Collection

NOTE Only use the Centralized Collection function after consulting with Munters technical support.

- Only the group owner or administrator can define the General Settings. The following tab does appear on any other user's screen.
- The General Settings page is an option. If data upload is to a local server only, leave these fields blank and go to Defining the FTP/SFTP server.
- The General Settings tab is viewable via the web only. It is not viewable from a local connection.

1. In the settings icon, select Farm Settings.

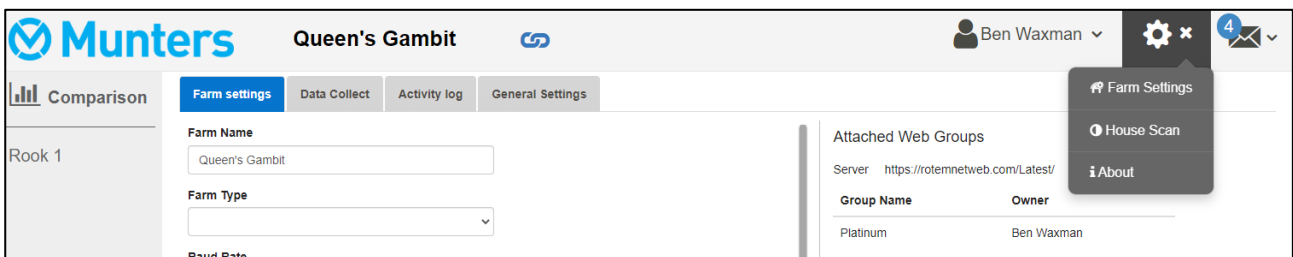

Figure 90: Farm Settings Drop Down

2. Go to Farm Settings > General Settings.

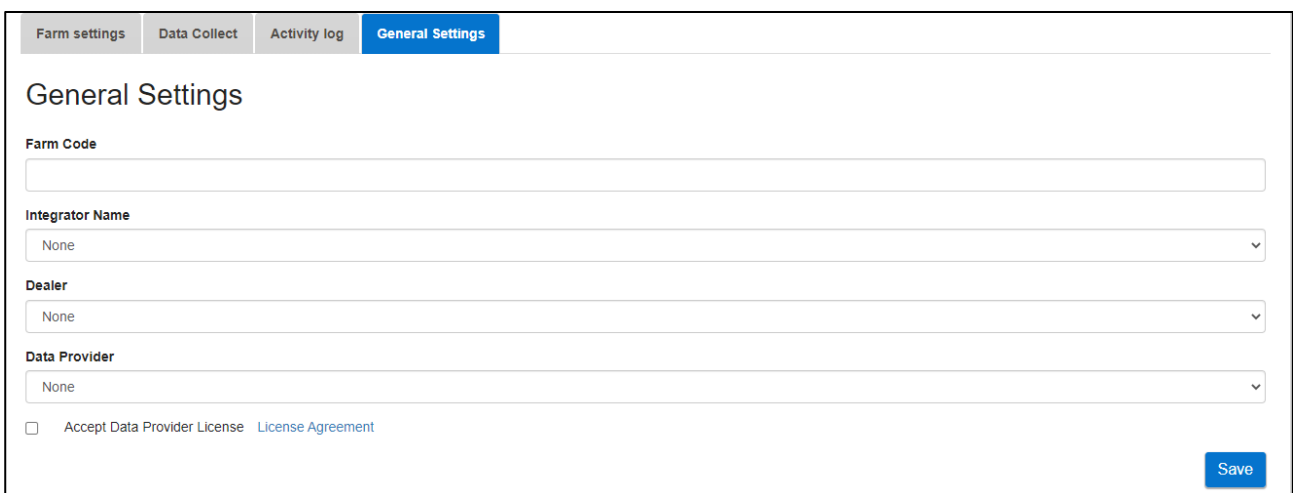

Figure 91: General Settings Screen

3. Enter the data as follows:

- Farm Code: This is a code provided by the integrator used to identify the farm.
- Integrator Name: From the drop-down list, select the required name.
- Dealer: From the drop-down list, select the required dealer name.

- Data Provider: From the drop-down list, select the required data provider.
- Accept Data Provider License. Mark this box. This box must be checked to enable centralized data collection.

NOTE This acceptance is saved.

The screenshot shows a web interface with a navigation bar containing tabs: Farm settings, Push Notifications, Data Collect, Activity log, and General Settings (highlighted in blue). Below the tabs is the 'General Settings' section. It contains four input fields: 'Farm Code' with the value '1234', 'Integrator Name' with a dropdown menu showing 'Other', 'Dealer' with a dropdown menu showing 'Other', and 'Data Provider' with a dropdown menu showing 'Other'. Below these fields is a checkbox labeled 'Accept Data Provider License' followed by a blue link 'License Agreement'. A blue 'Save' button is located at the bottom right of the form.

Figure 92: General Settings – Completed (Example)

NOTE: If you click Save without marking the License radio box, the following message appears:

The screenshot shows a modal dialog box with a dark grey header containing the text 'General Settings'. The main body of the dialog has a white background with black text that reads: 'Dear User, You have edited the General Settings fields. To continue using the data upload services, you must click “Accept Data Provider License”. Click No to return to the page and check the box. Click Yes to continue.' At the bottom left of the dialog, there are two buttons: 'Yes' (highlighted in blue) and 'No'.

Figure 93: License Warning

- Click No to return to the page and accept the license.
 - Click Yes if you do not wish to use the data upload services.
4. Click the Data Collect tab. Refer to the following section.

10.2 Defining the FTP/SFTP server

Use this function to enable data collection to your FTP/SFTP site.

NOTE *Data Upload Allowed* appears if the General Settings fields are filled out and Data Provider License accepted. If the fields are filled out but the license is **NOT** accepted data, upload is disabled.

The screenshot shows a web interface for configuring an FTP/SFTP server. At the top, there are navigation tabs: Farm settings, External Devices, Push Notifications, Local Users, Data Collect (highlighted), and Activity log. Below the tabs is a 'Data Upload Settings' section with a 'Log' button. The 'Data Upload Settings' section is expanded, showing a green status 'Data Upload Allowed'. It contains several input fields: 'Farm name for collect' (value: Farm), 'License key' (value: a65212f8-56a4-4bab-85d6-48b22e54cf2), 'Expired date' (value: 30/05//2023), and 'Allow to change settings' (checkbox). Below these are two buttons: 'FTP' and 'SFTP', with an information icon. The next section is 'FTP Remote Server Details', which includes input fields for 'Host Address', 'Port Number' (value: 0), 'Target Folder', 'User Name', and 'Password'. Below that is the 'Collect Preferences' section, which is expanded to show 'Auto Collect' options: 'Alarm History' (checkbox), 'VFT' (checkbox), 'Collect Alarms every 1 minute' (checkbox), 'Select Output File Formats' (checkboxes for xml and MTech), and 'Define The Data Collection Interval' (dropdown menu with value 15 min.). Below 'Auto Collect' is the 'Select Houses' section, which has a checked checkbox for 'House Number' and a checked checkbox for 'House 1'. At the bottom left, there is a 'Save' button.

Figure 94: FTP Definition

- Data Upload Settings:
 - Check **Allow to change settings** to enable editing the page.
 - Select **FTP** or **SFTP** and check the box.
 - License key: This is a read-only field. The field is filled in automatically if you fill in the General Settings fields.
- FTP/SFTP Details: Fill in the fields as required.
- Collect Preferences:
 - Under **Select Houses**, select at least one house to enable changing Auto Collect settings.
 - Check Alarm History, VFT, and Collect Alarms every 1 minute as required.

CAUTION *Only mark the Alarm History, VFT, and Collect Alarms checkboxes if you are uploading data to a centralized collector. Anyone using a private FTP server must leave these boxes unchecked!*

- Select the output file format.
- Define the collection interval.

11 Appendix C: Adding a SIM Card/Modem

1. Remove the CommBox Plus cover.

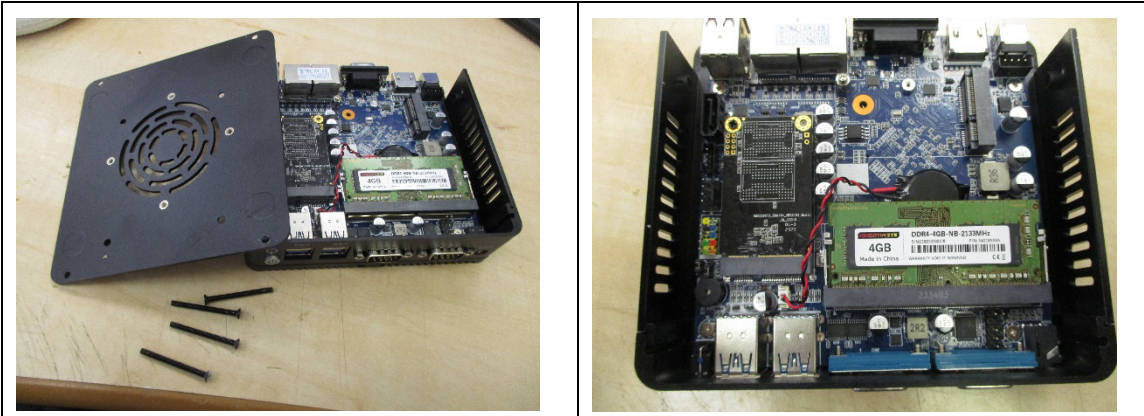

2. Open the clips securing the memory card.

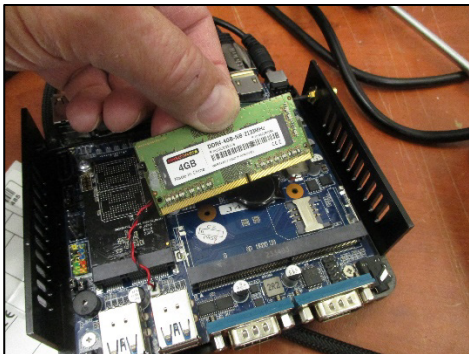

3. Place a working SIM card into the SIM slot. Place the card as shown in the following pictures.

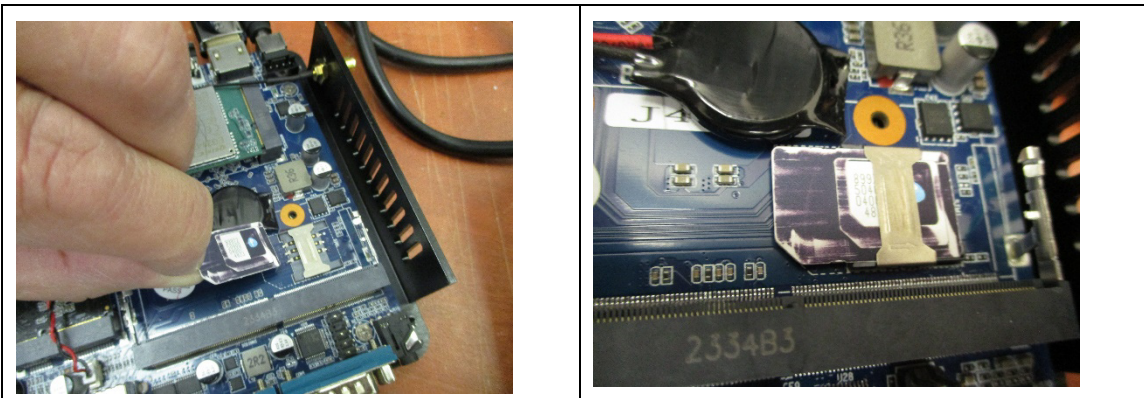

4. Put the memory card back in place.



5. On the right side of the unit is a plastic cover. Remove the cover.

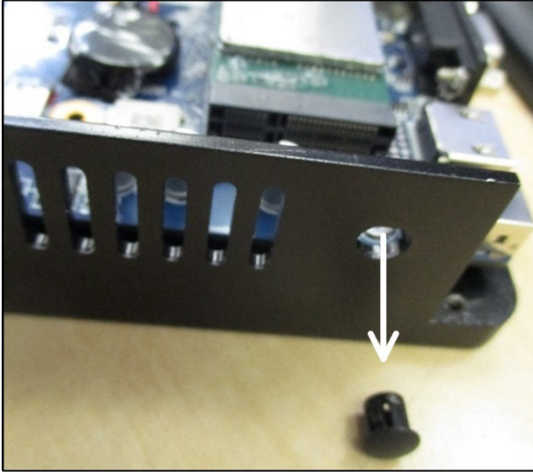

6. Place the modem on the MINIPCI-E1 connector and screw it in.

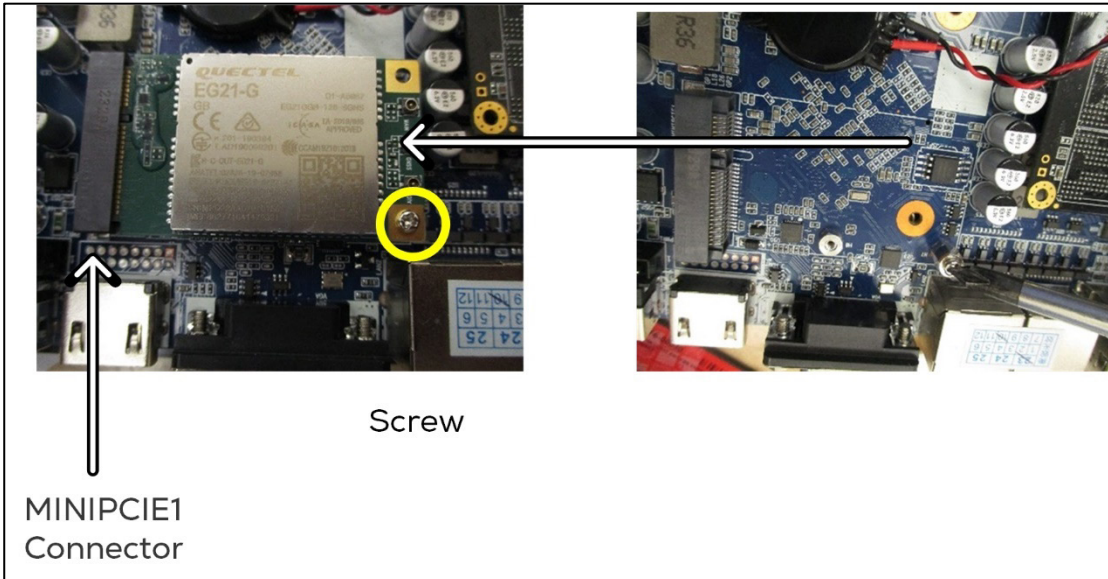

7. Attach the internal antenna to the modem's main connector and to the unit.

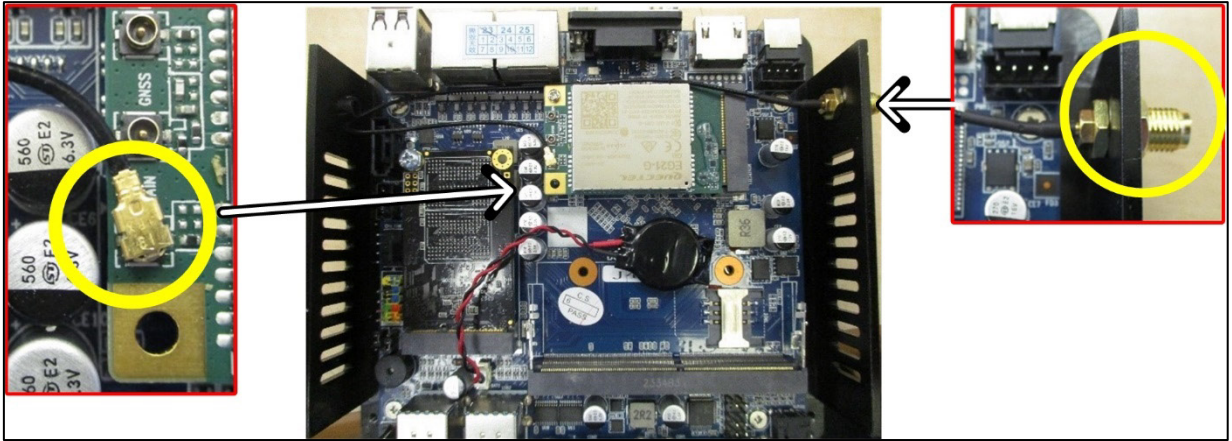

8. Attach the external antenna to the port.

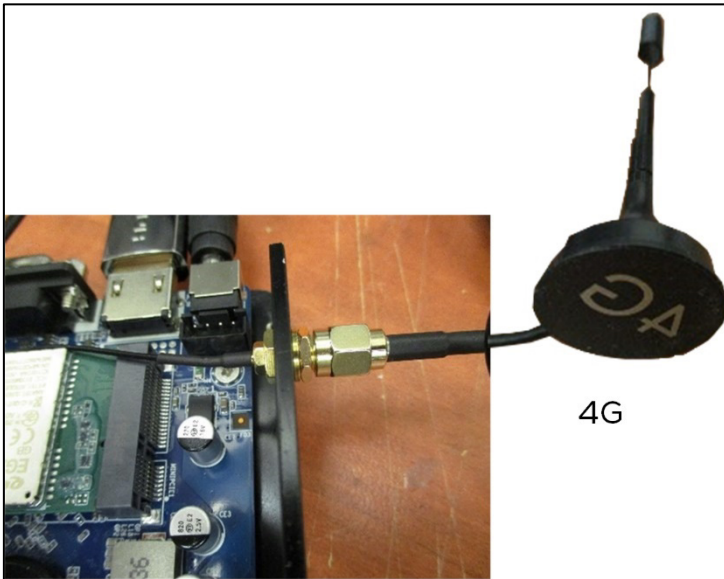

12 Warranty

Warranty and technical assistance

Munters products are designed and built to provide reliable and satisfactory performance but cannot be guaranteed free of faults; although they are reliable products they can develop unforeseeable defects and the user must take this into account and arrange adequate emergency or alarm systems if failure to operate could cause damage to the articles for which the Munters plant was required: if this is not done, the user is fully responsible for the damage which they could suffer.

Munters extends this limited warranty to the first purchaser and guarantees its products to be free from defects originating in manufacture or materials for one year from the date of delivery, provided that suitable transport, storage, installation and maintenance terms are complied with. The warranty does not apply if the products have been repaired without express authorisation from Munters, or repaired in such a way that, in Munters' judgement, their performance and reliability have been impaired, or incorrectly installed, or subjected to improper use. The user accepts total responsibility for incorrect use of the products.

The warranty on products from outside suppliers fitted to CommBox Plus, (for example power supplies, cables, etc.) is limited to the conditions stated by the supplier: all claims must be made in writing within eight days of the discovery of the defect and within 12 months of the delivery of the defective product. Munters has thirty days from the date of receipt in which to take action, and has the right to examine the product at the customer's premises or at its own plant (carriage cost to be borne by the customer).

Munters at its sole discretion has the option of replacing or repairing, free of charge, products which it considers defective, and will arrange for their despatch back to the customer carriage paid. In the case of faulty parts of small commercial value which are widely available (such as bolts, etc.) for urgent despatch, where the cost of carriage would exceed the value of the parts, Munters may authorise the customer exclusively to purchase the replacement parts locally; Munters will reimburse the value of the product at its cost price.

Munters will not be liable for costs incurred in demounting the defective part, or the time required to travel to site and the associated travel costs. No agent, employee or dealer is authorised to give any further guarantees or to accept any other liability on Munters' behalf in connection with other Munters products, except in writing with the signature of one of the Company's Managers.

WARNING: In the interests of improving the quality of its products and services, Munters reserves the right at any time and without prior notice to alter the specifications in this manual.

The liability of the manufacturer Munters ceases in the event of:

- dismantling the safety devices;
- use of unauthorised materials;
- inadequate maintenance;
- use of non-original spare parts and accessories.

Barring specific contractual terms, the following are directly at the user's expense:

- preparing installation sites;
- providing an electricity supply (including the protective equipotential bonding (PE) conductor, in accordance with CEI EN 60204-1, paragraph 8.2), for correctly connecting the equipment to the mains electricity supply;
- providing ancillary services appropriate to the requirements of the plant on the basis of the information supplied with regard to installation;
- tools and consumables required for fitting and installation;
- lubricants necessary for commissioning and maintenance.

It is mandatory to purchase and use only original spare parts or those recommended by the manufacturer.

Dismantling and assembly must be performed by qualified technicians and according to the manufacturer's instructions.

The use of non-original spare parts or incorrect assembly exonerates the manufacturer from all liability.

Requests for technical assistance and spare parts can be made directly to the nearest [Munters office](#).

