

User Manual

Platinum  
Touch /  
One



# Platinum Touch/One Controllers

Climate Controllers for Poultry and Pigs

Ag/MIS/UMGB-2444-03/17 Rev 2.1  
P/N: 117556



# Platinum Touch/One

## User Manual

Revision: N2.1 of 08.2023

Product Software: 7.24.04

This manual for use and maintenance is an integral part of the apparatus together with the attached technical documentation.

This document is destined for the user of the apparatus: it may not be reproduced in whole or in part, committed to computer memory as a file or delivered to third parties without the prior authorization of the assembler of the system.

Munters reserves the right to effect modifications to the apparatus in accordance with technical and legal developments.

# Index

<i>Chapter</i>		<i>page</i>
<b>1</b>	<b>INTRODUCTION.....</b>	<b>11</b>
1.1	Disclaimer.....	11
1.2	Introduction .....	11
1.3	Notes .....	11
<b>2</b>	<b>INTRODUCTION TO THE PLATINUM TOUCH/ ONE CONTROLLER .....</b>	<b>12</b>
2.1	Main Screen.....	12
2.2	Menu Elements.....	13
2.3	Version .....	14
2.4	Software Upgrade .....	14
2.5	One LEDs.....	15
2.6	Selecting the Mode .....	15
<b>3</b>	<b>CONTROL MENU .....</b>	<b>16</b>
3.1	Temperature Curve .....	17
3.1.1	Temperature Curve Help   Set Definitions.....	18
3.1.2	Cycle Heaters Help   Set Definitions.....	19
3.1.3	Radiant Heaters Help   Set Definitions .....	21
3.1.4	Variable Heater Help   Set Definitions .....	22
3.1.4.1	Linear Heat.....	23
3.1.4.2	Proportional Heat.....	24
3.1.4.3	Linear Valve .....	24
3.1.5	Temperature Humidity Index.....	25
3.1.5.1	Defining THI .....	25
3.1.5.2	THI Screens .....	27
3.2	Minimum/Maximum Level.....	27
3.2.1	By Day and By Days with Curve .....	27
3.2.2	By Time.....	28
3.2.3	Soft Min / Max .....	29
3.2.3.1	Soft Min/Max Level Help   Set Definitions.....	29
3.2.4	By Weight.....	30
3.2.4.1	Min/Max Level By Weight Help   Set Definitions Version 7.18 and Below .....	31
3.2.4.2	Min/Max Level By Weight Help   Set Definitions Version 7.19 .	32
3.3	Soft Maximum Levels.....	33
3.3.1	Introduction.....	34

3.3.2	Soft Minimum Screens.....	35
3.3.3	Soft Min Max Levels.....	36
3.4	Introduction to Humidity, Ammonia, and CO2 Treatment.....	37
3.5	Humidity Treatment.....	37
3.5.1	Humidity Screen Main Screen.....	37
3.5.2	Humidity Treatment Help   Set Definitions.....	38
3.6	CO2 Treatment.....	39
3.6.1	CO2 Main Screen.....	39
3.6.2	CO2 Treatment Help   Set Definitions.....	41
3.7	Natural Ventilation.....	42
3.7.1	How Does Natural Ventilation Work.....	42
3.7.2	Preliminary Steps.....	42
3.7.3	Defining Natural Conditions.....	44
3.7.3.1	Defining Natural Operation, Version 7.18 and Below.....	44
3.7.3.2	Defining Natural Operation, Version 7.19.....	45
3.7.4	Defining Natural Operation.....	46
3.7.5	Natural Programming Help   Set Definitions.....	47
3.7.6	What Happens When the Controller Transitions?.....	48
3.8	Static Pressure.....	48
3.8.1	Static Pressure Method.....	48
3.8.1.1	Attic Static Pressure.....	48
3.8.1.2	Minimum Ventilation Static Pressure.....	49
3.8.1.3	Tunnel Ventilation Static Pressure.....	49
3.8.2	Disabling the Static Pressure Sensor.....	50
3.8.3	Static Pressure Help   Set Definitions.....	50
3.8.4	Multi Stage Tunnel Curtains.....	51
3.9	Cool Pad.....	51
3.9.1	Cool Pad, Version 7.21 and Below.....	51
3.9.1.1	Cool Pad, Main Screen.....	51
3.9.1.2	Cool Pad Help   Set Definitions.....	52
3.9.2	Cool Pad, Version 7.22 and Above.....	53
3.9.2.1	Cool Pad Main Screen.....	54
3.9.2.2	Cool Pad Help   Set Definitions.....	56
3.10	Foggers.....	56
3.10.1	Foggers Help   Set Definitions.....	57
3.11	Water & Feed Control.....	58
•	Water.....	58
3.11.1	Control via Time.....	58
3.11.2	Control via Quantity.....	59
3.11.3	Control by Feed Counter.....	60
3.11.4	Water and Feed Help   Set Definitions.....	62



3.12	Light .....	63
3.12.1	Light Help   Set Definitions .....	64
3.12.2	Light Measurement Control.....	66
3.13	Extra Systems .....	67
3.14	Control Mode.....	68
3.14.1	Control Mode Main Screen.....	68
3.14.2	Catching Mode .....	69
3.15	System Parameters .....	70
3.16	Ammonia Treatment .....	70
3.16.1	Ammonia Treatment Help   Set Definitions .....	71
3.17	Feed Scale Program .....	71
3.17.1	Feed Scale Help   Set Definitions .....	73
3.17.2	Operating Mode.....	74
3.17.3	Feed Scale Hot Screen .....	74
3.17.4	Feed Scale Functionality in Two Houses .....	75
3.18	Light Dimmers .....	78
3.19	Water Dosing.....	80
3.19.1	Water Dosing Main Screen.....	80
3.19.2	Water Dosing Help   Set Definitions .....	81
<b>4</b>	<b>MANAGEMENT MENU .....</b>	<b>82</b>
4.1	Bird Inventory .....	83
4.2	Feed Inventory.....	83
4.2.1	Feed Inventory Main Screen .....	83
4.2.2	Feed Inventory Help   Set Definitions.....	84
4.3	Growth Day and Flock .....	84
4.4	Alarm Settings.....	85
4.4.1	Alarm Setting Help   Set Definitions.....	87
4.4.2	Prioritizing Alarms.....	90
4.5	Alarm Reset .....	90
4.6	Fail Safe Settings.....	91
4.7	Password.....	92
4.8	Feeders & Drinkers.....	92
4.8.1	Feeders & Drinkers Main Screen .....	92
4.8.2	Feeders & Drinkers Help   Set Definitions .....	93
4.9	Nipple Flushing.....	93
4.9.1	Scheduling the Flush.....	94
4.9.2	Flushing Order.....	94
4.9.3	Nipple Flushing by Temperature .....	94
4.10	Water on Demand .....	95
4.10.1	Relay Control .....	96
4.10.2	Sensor Control.....	96

4.10.3	Water on Demand Help   Set Definitions .....	97
4.11	Current Sense .....	97
4.12	RDT-5 .....	98
4.12.1	Configuring the RDT-5 .....	98
4.12.2	RDT-5 / Temperature Curve   Set Definitions .....	99
4.12.3	RDT-5 Digital Alarm .....	100
4.12.4	Saving and Loading RDT-5 Tables .....	100
4.12.5	RDT-5, Version 7.22 .....	100
<b>5</b>	<b>HISTORY MENU .....</b>	<b>102</b>
5.1	Temperature History .....	103
5.2	Humidity History .....	103
5.3	CO2 History .....	104
5.4	Bird Weight History .....	104
5.5	Feed Conversion .....	105
5.6	Water Consumption History .....	105
5.7	Feed Consumption History .....	106
5.8	Mortality .....	107
5.9	Heaters History .....	108
5.10	Radiant Heaters History .....	108
5.11	Variable Heaters History .....	109
5.12	Alarms History .....	109
5.13	Table of Events .....	110
5.14	Power Consumption .....	110
5.15	History View .....	111
5.16	Ammonia History .....	112
5.17	Dosing History .....	112
<b>6</b>	<b>SYSTEM MENU .....</b>	<b>113</b>
6.1	Scales Testing .....	114
6.2	Hardware Checklist .....	114
6.3	Setup .....	115
6.3.1	Static Pressure Unit Definition .....	115
6.4	Time & Date .....	116
6.5	Levels of Ventilation .....	116
6.5.1	Introduction to Ventilation .....	116
6.5.2	Exhaust and Tunnel Fans .....	117
6.5.2.1	Exhaust and Tunnel Fans Help   Set Definitions .....	118
6.5.2.2	Wind Chill .....	119
6.5.3	Vent & Curtain Levels .....	120
6.5.3.1	Vent & Curtain Levels Help   Set Definitions Version .....	120
6.5.4	Variable Speed Fan Levels .....	121

6.5.5	Stir and Variable Fan Levels .....	121
6.6	Stir Fan Program .....	122
6.6.1	Stir Fan Program Help   Set Definitions.....	123
6.6.1.1	Program A (for Heaters).....	123
6.6.1.2	Program B (for Min Vent).....	124
6.6.1.3	Program C, D, E (Sensors Diff Temp or Independent) .....	124
6.7	Relay Layout .....	125
6.7.1	Output Function List .....	126
6.7.2	Relay Layout Settings.....	127
6.8	Sensors.....	127
6.8.1	Analog Sensors .....	127
6.8.2	Digital Sensors.....	128
6.9	Analog Output.....	129
6.9.1	Light Dimmer, Variable Speed Fan, Variable Heater, Variable Stir Fan Control .....	129
6.9.2	Vent, Tunnel, and Curtain Analog Output Control .....	129
6.10	Temperature Definition.....	130
6.11	Vent/Curt Setup.....	131
6.11.1	Using Time to Calibrate.....	131
6.11.2	Using a Potentiometer to Calibrate .....	132
6.11.3	Using Wind Direction .....	133
6.11.4	Stop Fans.....	133
6.11.5	Vent/Curtain Help   Set Definitions .....	133
6.12	House Dimensions .....	134
6.13	Fan Air Capacity .....	135
6.14	Setting up a Bird Weight Curve - Summary.....	135
6.15	Non-Gender Based Weighing .....	135
6.15.1	Scale Layout.....	136
6.15.1.1	Scale Layout Main Screen .....	136
6.15.1.2	Scale Layout   Set Definitions.....	136
6.15.2	Bird Scale Setting .....	137
6.15.2.1	Bird Scale Setting Screen.....	137
6.15.2.2	Bird Scale Setting   Set Definitions .....	137
6.15.3	Bird Weight.....	138
6.15.3.1	Bird Weight Main Screen .....	138
6.15.3.2	Bird Weight Help   Set Definitions .....	139
6.16	Gender Based Weighing .....	139
6.16.1	Auto or Auto Turkey Curve .....	141
6.16.2	Customized/Industrial Standard Curves.....	142
6.17	Silo Setting.....	143
6.18	Communication .....	144

6.19	System Update .....	144
<b>7</b>	<b>APPENDIX A: OUTPUT DATA .....</b>	<b>145</b>
<b>8</b>	<b>APPENDIX B: KEYBOARD FUNCTIONS .....</b>	<b>148</b>
8.1	Service Menu .....	148
8.1.1	Temperature Calibration .....	149
8.1.2	Humidity Calibration .....	149
8.1.3	CO2 Sensor Calibration .....	150
8.1.4	Static Pressure Calibration .....	150
8.1.5	Light Sensor Calibration .....	152
8.1.6	Feed Calibration .....	152
8.1.7	Water Calibration .....	153
8.1.8	Ventilation Potentiometer Calibration .....	153
8.1.9	Save Settings .....	153
8.1.10	Load Settings .....	154
8.1.11	Load Settings Report .....	155
8.1.12	Current Sense Relay Calibration .....	155
8.1.13	Wind Direction Calibration .....	156
8.1.14	WOD Calibration .....	157
8.1.14.1	WOD Screen .....	157
8.1.14.2	WOD Calibration Help   Set Definitions .....	157
8.1.15	Ammonia Calibration .....	157
8.2	Management Menu: Relay Current .....	158
8.3	Scale Menu .....	159
8.3.1	Test .....	159
8.3.2	Scale and Silo Calibration .....	159
8.3.2.1	Scale Calibration .....	159
8.3.2.2	Silo Calibration .....	160
8.4	Test Menu .....	161
8.4.1	Alarm .....	161
8.4.2	Analog Sensors .....	161
8.4.3	Digital Sensors .....	162
8.4.4	Analog Output .....	162
8.4.5	Static Pressure .....	163
8.4.6	Communication .....	163
<b>9</b>	<b>APPENDIX C: LAYERS MODE .....</b>	<b>164</b>
9.1	Layers Main Screen .....	164
9.2	Layers Vent and Curtain Levels .....	165
9.2.1	Layer Inlet Control .....	165
9.2.1.1	Pressure Control .....	166
9.2.1.2	Position Control .....	166

9.2.2	Layer Vent & Curtain (Inlet) levels help   set definitions .....	167
<b>10</b>	<b>APPENDIX D: BREEDERS MODE.....</b>	<b>169</b>
10.1	Egg Room Setup.....	169
10.2	Egg Counter.....	172
10.3	Egg Room Water and Feed.....	173
10.3.1	Setup.....	174
10.3.2	Water and Feed Version 7.24 and Above.....	175
10.4	Egg Belt Runtime .....	176
10.5	Nest Function.....	177
10.5.1	Single Relay .....	177
10.5.2	Dual Relay .....	178
10.6	Work Room Control.....	179
10.7	Scale Arm.....	180
10.8	Weighing the Birds in Breeder.....	181
10.8.1	Bird Scale Setting .....	181
10.8.1.1	Measuring Bird Weights, Auto Curve .....	181
10.8.1.2	Measuring Bird Weights, Customized/Industrial Standard Curve .....	182
10.8.2	Bird Weight History .....	184
10.9	Breeder Advanced Feeding .....	184
10.9.1	Selecting the Mode.....	187
10.9.2	Setup.....	188
10.9.3	Feed Scale Program Help   Set Definitions.....	193
10.10	Egg Room History.....	194
<b>11</b>	<b>APPENDIX E: FUNCTIONS IN PREVIOUS VERSIONS.....</b>	<b>195</b>
11.1	Bird Weighing, Version 7.21 and Below.....	195
11.1.1	Setting up a Curve – Summary.....	195
11.1.2	Bird Curve/Bird Weight.....	196
11.1.2.1	Bird Curve, Version 7.18 and Below.....	196
11.1.2.2	Bird Weight, Version 7.19 .....	196
11.1.3	Scale Settings .....	198
11.1.3.1	General Settings.....	198
11.1.3.2	Bird Scale .....	199
11.1.3.3	Bird Scale Setting, Version 7.19 .....	200
11.1.3.4	Feed Bin/Silo Setting .....	201
11.1.4	Gender Based Weighing .....	202
11.1.4.1	Enabling Gender Based Weighing .....	202
11.1.4.2	Measuring Gender-Defined Bird Weights, Auto Curve.....	203
11.1.4.3	Measuring Gender-Defined Bird Weights, Customized/Industrial Standard Curve.....	204
11.1.5	Silo / Auger Layout Version 7.17 and Below.....	206

11.1.6	Bird Weight History, Version 7.18 and Below .....	207
11.2	Scale Test, Version 7.17 and Below .....	208
11.3	Vent & Curtain Levels Help   Set Definitions Version, 7.18 or Below.....	208
11.4	Breeder Nest Function, Version 7.18 and Below.....	209
12	<b>WARRANTY</b> .....	<b>210</b>

# 1 Introduction

## 1.1 Disclaimer

Munters reserves the right to make alterations to specifications, quantities, dimensions etc. for production or other reasons, subsequent to publication. The information contained herein has been prepared by qualified experts within Munters. While we believe the information is accurate and complete, we make no warranty or representation for any particular purposes. The information is offered in good faith and with the understanding that any use of the units or accessories in breach of the directions and warnings in this document is at the sole discretion and risk of the user.

## 1.2 Introduction

Congratulations on your excellent choice of purchasing a Platinum Touch or One!

In order to realize the full benefit from this product it is important that it is installed, commissioned and operated correctly. Before installation or using the controller, this manual should be studied carefully. It is also recommended that it is kept safely for future reference. The manual is intended as a reference for installation, commissioning and day-to-day operation of the Munters Controllers.

## 1.3 Notes

Date of release: July 2010

Munters cannot guarantee to inform users about the changes or to distribute new manuals to them.

*NOTE All rights reserved. No part of this manual may be reproduced in any manner whatsoever without the expressed written permission of Munters. The contents of this manual are subject to change without notice.*

# 2 Introduction to the Platinum Touch/ One Controller

This document describes the Platinum Touch/One Controller.

- [Main Screen](#)
- [Menu Elements](#)
- [Version](#)
- [Software Upgrade](#)
- One LEDs
- Selecting the Mode

## 2.1 Main Screen

Figure 1 shows the Platinum Touch/One Main Screen.

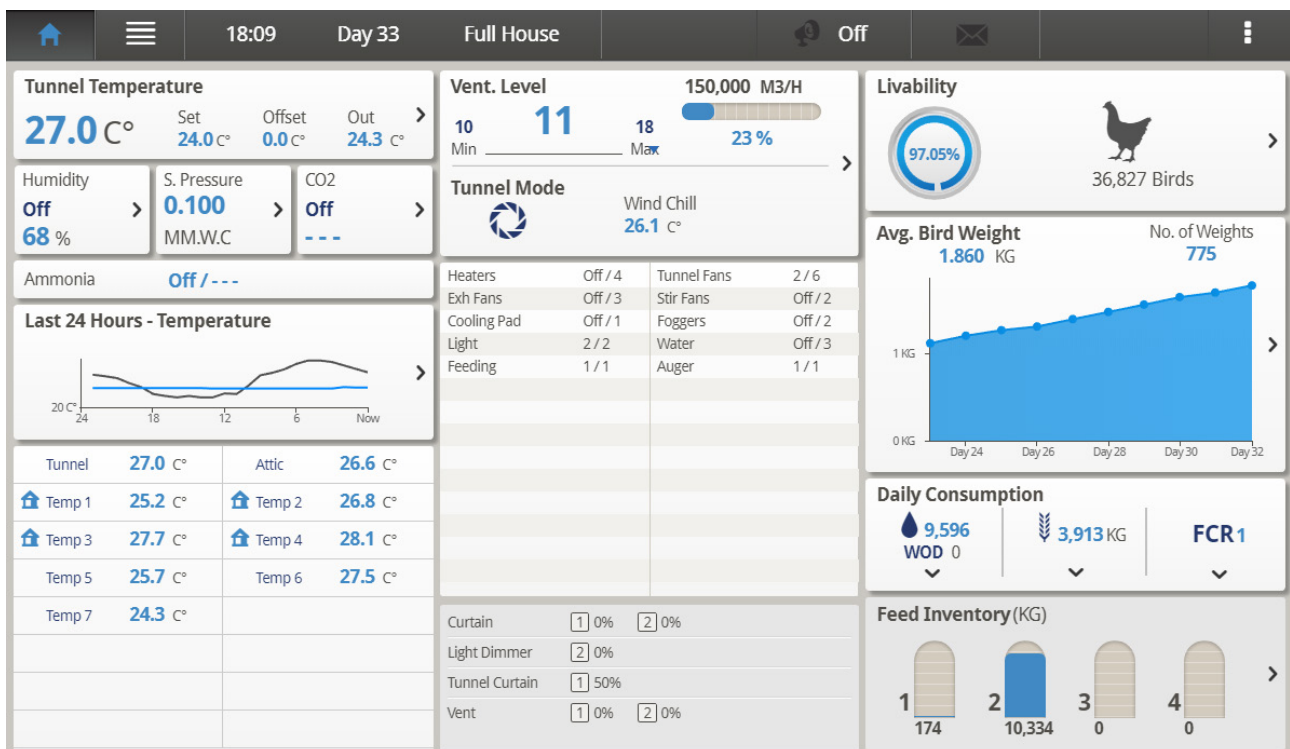

Figure 1: Platinum Touch/One Main Screen







- **Temperature:** Displays the average temperature, the set point the offset differential, and outdoor temperature. Click on it to go to the [Temperature Curve](#).
- **Ventilation level:** This section displays the current minimum ventilation level and percentage of air capacity being utilized. If minimum ventilation is being utilized,



the screen displays the cycle state and times. Click on it to go to [Levels of Ventilation](#).

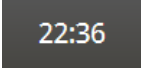
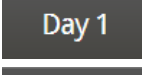
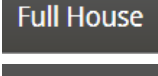

- **Livability:** Current number of living birds and the corresponding percentage relative to the original number. Click on it to go to [Bird Inventory](#).
- **Current relative humidity, static pressure, and CO2 levels.** Click on it to go to the [Humidity Treatment](#), [Static Pressure](#), and [CO2 Treatment](#) screens.
- **Average bird weight graph:** This graph summarizes the flock's weight over the growth cycle. Click on it to go to [Bird Weight History](#).
- **Temperature over the last 24 hours.** Click on it to go to the [History View](#).
- **Alarm messages.** The Main Screen lists the latest alarms.
- **Sensors:** This area displays the tunnel and attic target temperatures, the temperature readings for each individual temperature sensor, and the wind speed.
- **Feed Inventory:** Shows the current feed levels in the silos. Click to go to [Feed Inventory](#).

## 2.2 Menu Elements

	
	Click to return to the Main Screen
	Click to open the Menu.
	Displays the current time
	Displays the growth day
	Displays the house status (full house or brood mode) defined in the
	Click this button to prevent any user from making changes to the parameters.
	Click to turn off alarms. However, Platinum Touch/One continues to register alarms until alarms are reset.
	Click to read controller error messages
	Click one of these links to view screens summarizing information on this function: Curve Status, Light Status, Natural Ventilation, Analog Output Status, Temperature & Humidity Status, Feed Scale Status, Water Meters.

## 2.3 Version

- Go to System > Version to see the unit's software version.

Version			 
Name	Version	Date	
Controller Version	7.17.5		
UI Server Version	3.2.0.0	9/2/2018 6:33:54 PM	
UI Client Version	3.2.0.0	9/2/2018 6:33:50 PM	

## 2.4 Software Upgrade

You can upgrade certain software programs from the Web application.

- Platinum Touch/One software
- Web application
- Comm-Box software

**NOTE** You cannot upgrade product software! Upgrade your product software using the procedures given in the product manuals.

**NOTE** Software upgrades can only be done locally!

1. Request the software upgrade from your dealer. You will be sent (via email, web transfer, etc.) a UPD file.
2. Place the file on a disk on key/flash drive.
3. Place the disk on key/flash drive into the controller's USB port (found on the Touch door interior).
4. On the Touch screen, go to System > Software Update. The following screen appears.

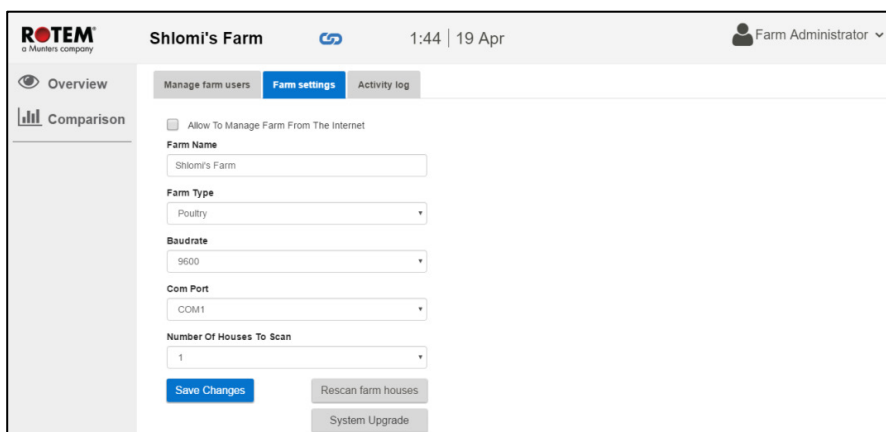
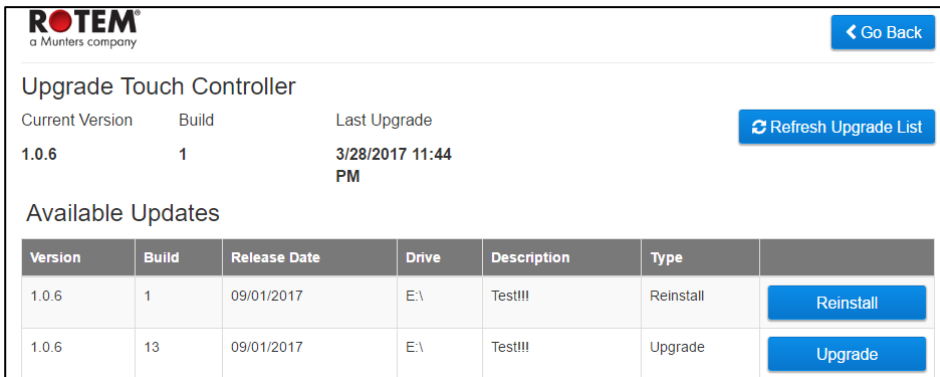
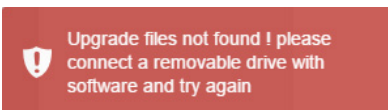

Figure 2: Farm Settings

5. Click System Upgrade. The following screen appears:



**NOTE** If you did not place the disk on key in the USB port, an error message appears:



6. The screen lists the UPD files on the disk. Select the required file and click Upgrade (or Downgrade if you are installing a previous version).

## 2.5 One LEDs

One Controller features LEDs on each relay panel. These LEDs turn red on all relay cards when there is any active alarm (even one); they are white when there are no alarms. Refer to the main screen to view the alarms.

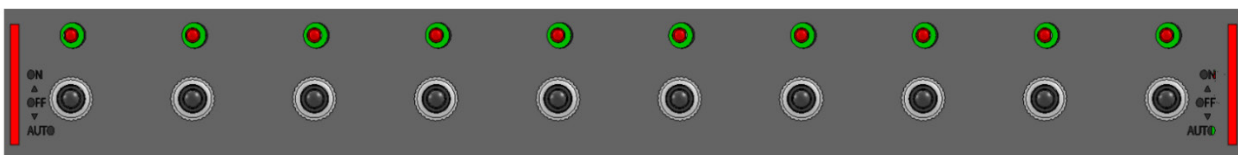

Figure 3: LEDs

## 2.6 Selecting the Mode

Platinum Touch/One runs in four modes: Broiler, Layer, Breeders, and Pigs.





To select the mode:

1. Open the door. Locate the keyboard.
2. Disconnect the power cable from the power source.
3. On the keyboard, press the Delete button and reapply power. The Cold Start screen appears.
4. Select Yes. Choose Controller Type appears.
5. Select the required mode.
6. Press Enter.

**NOTE** The manual is based on the Broiler Mode. Functions that are unique to Layers and Breeders and described in separate appendixes. Except for a few functions dealing with scales, Pig Mode supports the vast majority of functions seen in Broiler Mode. Pig Mode has some different terminology (for example herd instead of flocks).

- Appendix C: Layers Mode
- Appendix D: Breeders

# 3 Control Menu

 Control	Temperature Curve	Foggers	Feed Scale Program
 Management	Min/Max Levels	Water & Feed	Light Dimmers
 History	Humidity Treatment	Light	Water Dosing
 System	CO2 Treatment	Extra Systems	
	Natural Ventilation	Control Mode	
	Static Pressure	System Parameters	
	Cool Pad	Ammonia Treatment	

The following sections detail:

- Temperature Curve
- Minimum/Maximum Level
- Soft Maximum Levels
- Introduction to Humidity, Ammonia, and CO2 Treatment
- Humidity Treatment
- CO2 Treatment
- Natural Ventilation
- Static Pressure
- Cool Pad
- Foggers
- Water & Feed Control
- Light
- Extra Systems
- Control Mode
- System Parameters
- Ammonia Treatment
- Feed Scale Program
- Light Dimmers
- Water Dosing

*NOTE If an RLED 2.0 is connected to the Platinum Touch/One, the menu includes "Light Dimmers". Refer to Light Dimmers, page 78.*

### 3.1 Temperature Curve

This screen sets the temperature targets according to the bird age.

Temperature Curve						
Day	Target	Heat Off	Tunnel	Alarm		
				Low	High	Tunnel High
1	33.0	32.0	36.0	29	34	35
5	30.0	29.0	33.0	27	34	35
20	27.0	26.0	30.0	24	33	33
28	25.0	24.0	28.0	22	33	33
32	24.0	22.0	27.0	21	33	33
40	23.0	22.0	26.0	20	32	33
0	0.0	0.0	0.0	0	0	0
0	0.0	0.0	0.0	0	0	0
0	0.0	0.0	0.0	0	0	0

1. In *System > Sensors > Analog*, designate the required number of sensors as temperature sensors. When using more than one sensor, Platinum Touch/One begins treatments based on the average.

2. In *System > Temperature Definition*, assign specific sensors to devices. If a zone does not have an assigned sensor, calculations are based on the current average temperature.

3. In *Control > Temperature Curve*, define the required target temperature curve.

- Set up to 20 lines, 999 growth days. When a curve is not required (for example when growing layers), enter temperatures in the first line only.
- Define:
  - **Day:** Set the growth day. You can program negative growth days up to -7 for pre-warming.
  - **Target:** Set the desired temperature.
  - **Heat Off:** Set the temperature at which heating ceases.
  - **Tunnel:** Set the temperature at which tunnel ventilation begins.
  - **Low and High Alarm/Tunnel High:** Set temperature alarm limits.
    - Version 7.23 enables setting the temperature alarms to 0.X degrees (only when the temperature is set to Celsius).









Temperature Curve						
Day	Target	Heat Off	Tunnel	Alarm		
				Low	High	Tunnel High
1	26.7	25.6	32.2	23.9	35.0	35.0
5	27.0	26.5	32.5	24.5	35.2	35.2

4. In Management > [Alarm Settings](#), set the alarms.

5. If required, click  and set the parameters.

- Temperature Curve Help | Set Definitions
- Cycle Heaters Help | Set Definitions
- Radiant Heaters Help | Set Definitions
- Variable Heater Help | Set Definitions
- Temperature Humidity Index

### 3.1.1 TEMPERATURE CURVE HELP | SET DEFINITIONS

Temperature Curve - Settings			
Temperature Curve Offset	0.0 	Set Temperature Change Reminder (Diff.)	1.7 
Target Temperature Band	0.6 	Heater Temperature Band	0.6 
Cool Down Factor (%)	15 	Cool Down Fast Response (Deg.)	1.7 
Min Vent Below Heat Temperature By:	<input type="radio"/> None <input type="radio"/> Zone <input checked="" type="radio"/> Average	Non Brood Area Diff. From Heat	-55.0 
Cycle Heaters			
Low Heat Differential	0.6 	High Heat Differential	4.4 

- **Define:**
  - **Temperature Curve Offset:** Adjusts all temperature curves by this amount. You can use this to temporarily adjust all temperatures up or down for special circumstances. The curve appears in the [Curve Status Hot Screen](#). Use the ENTER and Up or ENTER and Down combinations to change the offset.
  - **Set Temperature Change Reminder (Diff):** Sets the change in set temperature that triggers a reminder for you to set backup thermostats. Often producers forget to set backup thermostats as their birds grow from baby chicks to market age, so the Platinum Touch/One reminds you. When you press Enter to acknowledge the reminder, the Platinum Touch/One logs it in the Table of Events.
  - **Target Temperature Band:** The size of the target temperature zone. This "Happy Zone" is between Target Temperature and (Target Temperature + Band).

- **Heater Temperature Band:** Heaters turn on at 'Band' degrees below Heat and turn off at the Heat Temperature.

*NOTE Heaters operate at minimum level only; however, Radiant Heaters can operate at any temperature or level below Tunnel.*

- **Cool Down Factor (%):** Minimum percentage correction towards target during each increase [ventilation level delay](#). If the average temperature does not decrease by this amount, the Platinum Touch/One increases ventilation by one level.
- **Cool Down Fast Response (Deg.):** Set a limit to the maximum degrees per minute of cooling. If Average Temperature drops more than this in one minute, Platinum Touch/One decreases ventilation one level to avoid overshooting.

*NOTE Avoid making this parameter too small or the normal temperature variation caused by timer fans reduces the ventilation level.*

- **Minimum Ventilation Below Heat Temp:** Tells controller to go directly to minimum level in some cases. Select from the following choices:
  - None: Operate by the normal level decrease time delay rule.
  - Zone: Go directly to minimum level if any active temperature sensor reaches heat temperature.
  - Avg.: Go directly to minimum level if the average temperature reaches heat temperature.
- **Non Brood Area Diff. From Heat:** Set differential temperature for non-brood heaters. You normally use this to set temperatures in unoccupied areas (poultry modes only).

*NOTE When set at -99 °F the heaters are effectively disabled, since it will probably never go to 99° F below the heater temperature. Putting this parameter at 0° sets the non-brood areas to the heater temperature.*

### 3.1.2 CYCLE HEATERS HELP | SET DEFINITIONS

Temperature Curve - Settings			
<b>Cycle Heaters</b>			
Low Heat Differential	0.6	High Heat Differential	4.4
Min On Time	30		
<b>Radiant Heaters</b>			
Radiant Low - Diff. From Heat Set	1.1	Radiant High - Diff. (Below Low Set)	0.6
Radiant Ignition Time (Sec.)	30		

Heat Cycle means providing heat in conjunction with the ventilation system during minimum ventilation cycles, using heaters and fans connected to relays. When enabled, heaters operate during the fans' cycle off time (as defined in the Cycle Heaters Help | Set Definitions parameters). How does it work?

Between the Heat Temperature and the differential temperature, heaters do not operate. When the temperature goes below the Heat Off temperature minus the Low Heat Differential:

- Heaters begin to operate when the exhaust or tunnel fans are off. Heaters operate for the Minimum On Time.
- If the temperature continues to drop, heaters operate for longer periods of time, up to the Maximum On Time (defined in Levels of Ventilation).
- Platinum Touch/One automatically generates a curve.

In this example:

- Temperature Curve Heat Off is 78°.
- Low Heat Differential is 1°.
- High Heat Differential is 8°.
- Minimum On time is 30 seconds.
- Cycle Off time is 270 seconds.

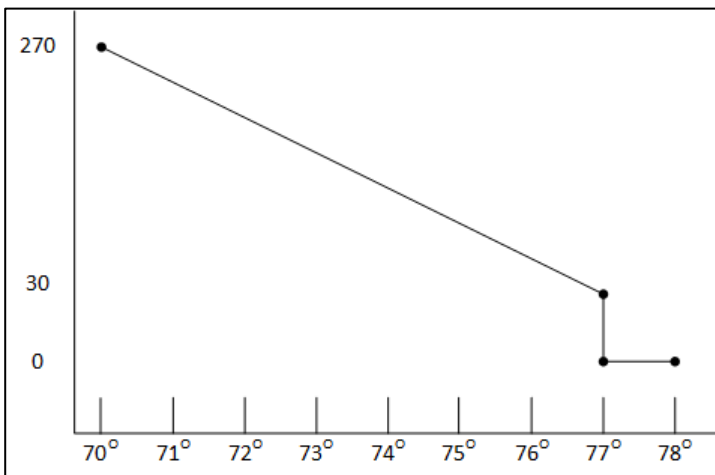

1. Define the required number of heater and exhaust and/or tunnel relays (Relay Layout, page 125).

2. In Control > Control Mode, set the Heater Cycle to Yes.

3. In Control > Temperature Curve > Help, scroll to Cycle Heater.

4. Define:

- Low Heat Differential: The differential below the Heat Off temperature, at which heating begins and runs for the minimum amount of time.
- High Heat Differential: The differential below the Heat Off temperature, at which heating runs for the maximum amount of time.
- Minimum ON Time: Minimum heating time when the exhaust or tunnel fans are off.



### 3.1.3 RADIANT HEATERS HELP | SET DEFINITIONS

Temperature Curve - Settings			
Min On Time	30		
Radiant Heaters			
Radiant Low - Diff. From Heat Set	1.1	Radiant High - Diff. (Below Low Set)	0.6
Radiant Ignition Time (Sec.)	30		
Variable Heaters			
Low Diff. Below Heat Temp.	0.6	High Diff. Below Heat Temp.	4.4

To configure the radiant heaters:

1. In *System > Relay Layout* define at least one relay as a radiant heater.

2. Define:

- **Radiant Low – Differential from Heat Set:** Set degree of difference from Heat for LOW Radiant Heaters to begin working. This differential can be positive or negative. (default: 2.0)
- **Radiant High – Differential (Below Low Set):** Set number of degrees below Radiant Low Heaters for HIGH Radiant Heaters to begin working (default: 1.0). To ensure proper heater ignition, Radiant High Heaters remain on for the Radiant Ignition Time along with the Radiant Low Heaters.
- **Radiant Ignition Time (sec):** Set number of seconds to power radiant ignition (default: 30).

7. **Version 7.20:** As an option, you can configure the Radiant Low – Differential from Heat Set parameter for each heater.

Radiant Heaters			
Individual Rad. Low Diff Set	<input checked="" type="radio"/> Yes <input type="radio"/>	Radiant Ignition Time (Sec.)	30
Radiant High - Diff. (Below Low Set)	0.6	Radiant Low - Diff. From Heat Set	1.1

- In the Individual Rad. Low Diff Set, define as Yes. An individual parameter for each heater appears.

**NOTE** The Heater Temperature Band applies to radiant heaters as well. For example, if the Heat Temperature is 80° F and the Heater Temperature Band is 1° F, then heaters turn on at 79° F and off at 80° F. If the Radiant Low Differential is at 2.0° F, then radiant heaters turn off at 82° F, and on 1° F below that at 81° F. However, a Radiant High Heater turns on regardless of its temperature setting for the Radiant Ignition Time whenever the corresponding Radiant Low Heater turns on. This feature ensures proper flame ignition.

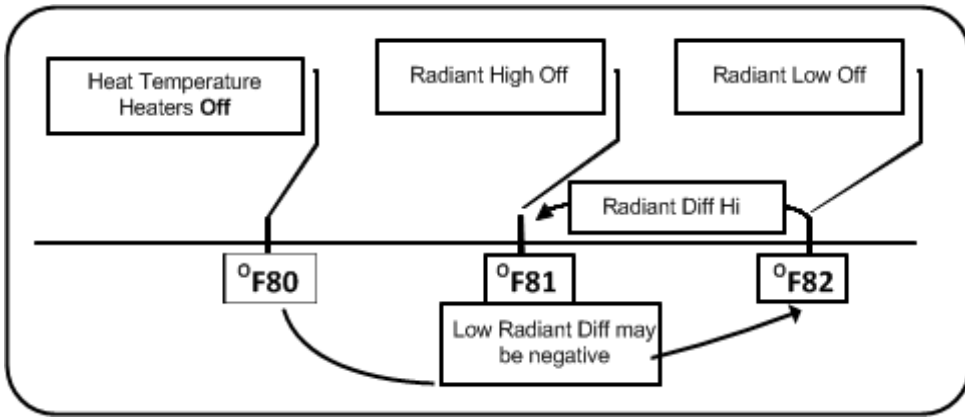
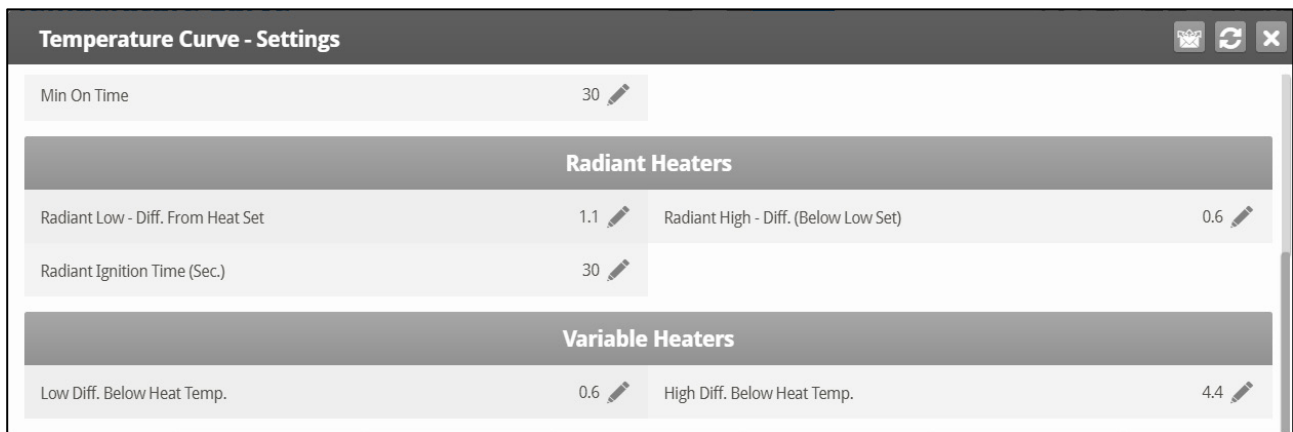

Figure 4: Radiant Heater Differentials

### 3.1.4 VARIABLE HEATER HELP | SET DEFINITIONS

The Platinum Touch/One enables configuring up to eight variable heaters. The output of the heaters changes as the temperature increases or decreases.



🔄 Install at least one analog output card.

To configure the variable heaters:

1. In *System* > *Analog Output* configure:
  - a. up to eight analog outputs as variable heaters.
  - b. the minimum and maximum voltage output for each heater.
2. In *Control* > *Control Mode*, define the Analog Heat Mode:
  - Linear Heat
  - Proportional Heat
  - Linear Valve

3. In *Control* > *Temperature Curve*, click  and scroll to Variable Heater.

4. Define the parameters as required.

### 3.1.4.1 Linear Heat

When Linear Mode is enabled:

- Between the Heat Temperature and the Target temperature, heaters do not operate (meaning, the output voltage is 0).
- Between the Heat Temperature and the Low Difference Below Heat, heaters operate at the minimum voltage output.
- If the temperature continues to drop, the voltage output increases until it reaches the maximum voltage output at the High Difference below Heat.

In this example:

- Target Temperature is 80°
- Temperature Curve Heat Off is 78°.
- Low Heat Differential is 1°.
- High Heat Differential is 8°.
  - If the temperature is between 77° to 78°, the output voltage is the minimum voltage defined in System > Analog Output (1 volt in this example).
  - If the temperature continues to drop, the output voltage increases until it reaches the maximum voltage defined in System > Analog Output. Output increases or decreases to keep the temperature within the Target Temperature and Heat Off band.

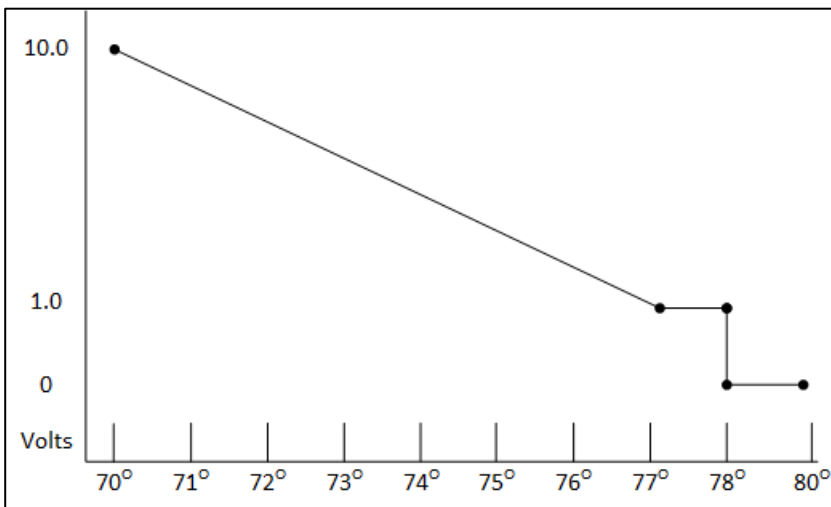

Figure 5: Linear Heat Curve

- Define:
  - **Low Difference Below Heat:** Temperature difference between the Heat Off parameter at which the variable heater begins to function.
  - **High Difference Below Heat:** Temperature at which the heater begins to operate at maximum output.

### 3.1.4.2 Proportional Heat

Proportional Heat works in manner similar to Linear Mode. The difference is that Proportional Heat features a delay time.

- When the temperature falls below the user-defined point, the heaters begin operating at their minimum output.
- After the response time passes, Platinum Touch/One checks the temperature. If it is still below the defined point, Platinum Touch/One increases the voltage by a certain amount (this amount of the increase cannot be changed).
- After the response time passes, the process is repeated until heaters operate at their maximum output.
- Define the parameters.
  - **Difference Above Heat to Stop Heater:** Differential from target temperature at which the heater runs at minimal input.
  - **High Difference Below Heat:** High Difference Below Heat: Temperature at which the heater begins to operate at maximum output.
  - **Response Time (seconds):** Amount of time before the controller begins to change the ventilation.

### 3.1.4.3 Linear Valve

Linear Valve enables defining that variable heater input voltage is always equal to or above the minimum input defined in System > Analog Sensors.

When the Analog Heat Mode is defined as having Linear Valve control, there is always a minimal voltage input. Therefore, if the minimum voltage is 1 volt:

- The voltage range is from 1 to 10 volts
  - this corresponds to 10% at 1V and 100% at 10V
  - interpolation inside the band
- There is 0% voltage when the target temperature is reached.

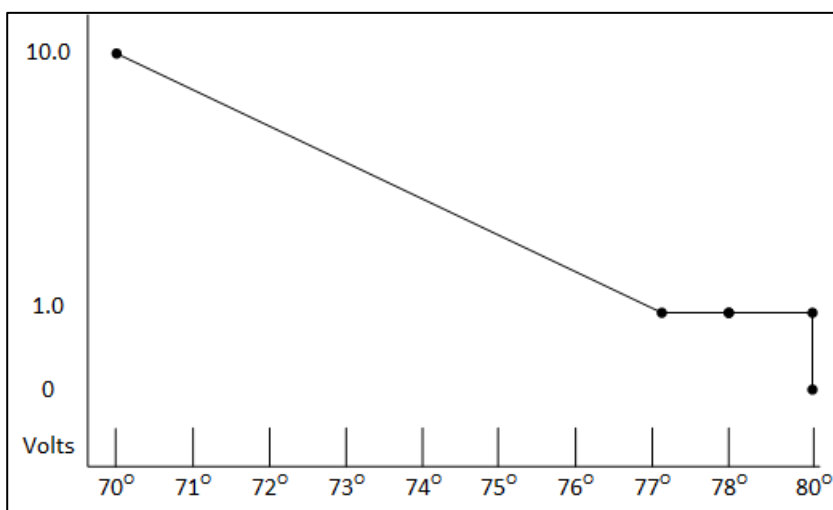

Figure 6: Linear Valve Curve

- Define:
  - **Difference Above Heat to Stop Heater:** Differential from target temperature at which the heater runs at minimal input
  - **High Difference Below Heat:** High Difference Below Heat: Temperature at which the heater begins to operate at maximum output.

### 3.1.5 TEMPERATURE HUMIDITY INDEX

As an option, Platinum Touch/One Version 7.20 can operate the ventilation according to a temperature-humidity index (THI), a formula that combines the temperature and humidity levels. This formula measures heat stress and is an industry standard that can be used to provide ventilation efficiently. Based on this formula, Platinum Touch/One recalculates the target and heat temperatures defined in the Temperature Curve screen. Ventilation is then based on the calculated values. Please note:

- The calculated target temperature can be higher or lower than the set target temperature.
- When this option is used, the Humidity Treatment screen is disabled.
- THI does not affect the Tunnel Temperature.
- THI does not affect CO2 or Ammonia treatments.
- THI temperatures only operate when the controller provides minimum ventilation or is operating in Natural Mode (meaning, not in Tunnel Mode).

#### 3.1.5.1 Defining THI

➔ THI requires installing and mapping a humidity sensor.

To enable THI ventilation:

1. In Control > Control Mode, enable THI Mode.

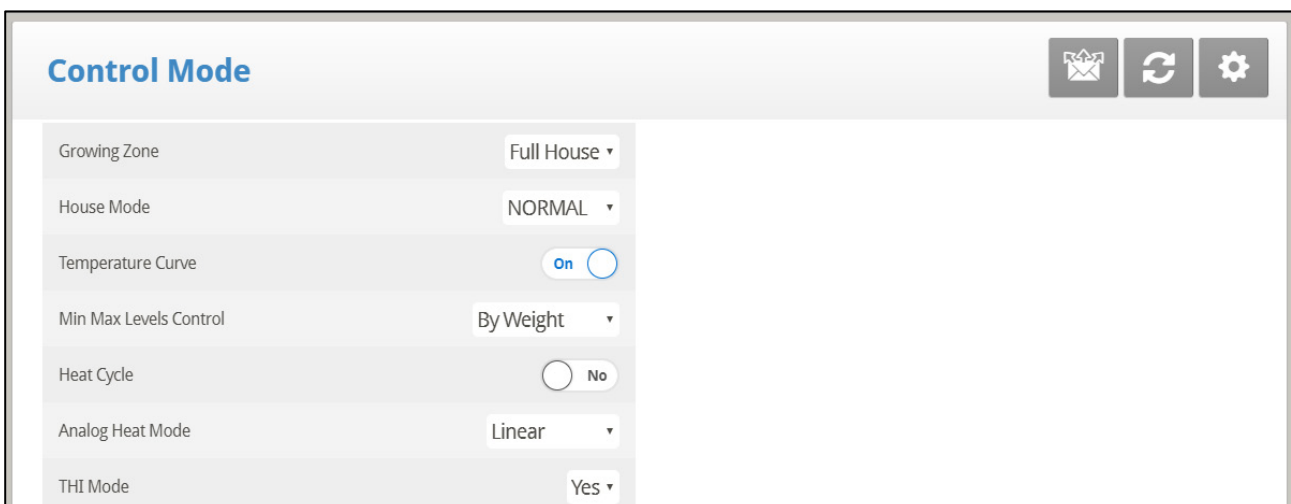

2. Go to Control > Temperature Curve > Help.

Temperature Curve - Settings			
Radiant High - Diff. (Below Low Set)	0.6	Radiant Low - Diff. From Heat Set	1.1
Variable Heaters			
Low Diff. Below Heat Temp.	0.6	High Diff. Below Heat Temp.	4.4
THI Mode			
RH Set Point (%)	65	Target Temp. Offset per 1%RH (Degree)	0.04
Max Target Temp. Offset (Degree)	3.00		

3. Define:

- **RH Set Point (%)**: Define the relative humidity at which THI begins recalculating the target and heat temperatures. Range: 55 – 75%.
- **Target Temperature Offset per 1% Relative Humidity**: Define the change in the target temperatures as relative humidity increases/decreases. This quantity is entered into a controller algorithm. Range: 0.0 – 0.4° C/0.0 – 0.9° F

*NOTE If the relative humidity rises above the set point, the target temperature drops. If the relative humidity drops below the set point, the target temperature rises. In each case, the ventilation changes accordingly.*

- **Maximum Target Temperature Offset (°)**: Define the maximum possible offset. Range: 0.10 – 10.0° C/0.18 – 18.0° F.
- **Version 7.23: Max Offset Above/Below Targ Temp(°)**: Define the maximum possible offset above and below the target temperature separately. Range: 0.10 – 10.0° C/0.18 – 18.0° F.

Temperature Curve - Settings			
Radiant High - Diff. (Below Low Set)	0.6	Radiant Low - Diff. From Heat Set	1.1
Variable Heaters			
Low Diff. Below Heat Temp.	0.6	High Diff. Below Heat Temp.	4.4
THI Mode			
RH Set Point (%)	65	Target Temp. Offset per 1%RH (Degree)	0.04
Max Target Temp. Offset Above Ref. (Degree)	3.00	Max Target Temp. Offset Below Ref. (Degree)	3.00

### 3.1.5.2 THI Screens

- The Main Screen will display the THI target temperature.

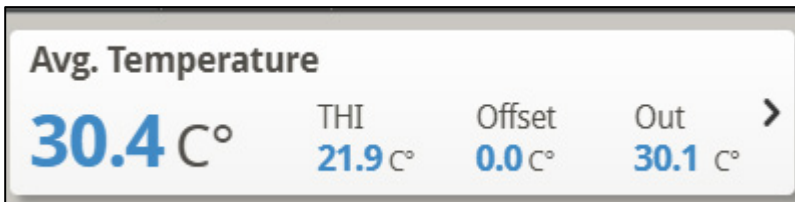

- Curve Hot Screen displays the THI temperatures along with the standard temperatures.

A screenshot of a "Curve Status" screen. It features a refresh icon in the top right corner. Below the title is a table with two columns of temperature data.

THI Target Temp.	21.9	Target Temp.	21.9
THI Heat Temp.	20.0	Heat Temp.	20.0
Tunnel Temp.	24.9	THI Low Alarm Temp.	14.4
Low Alarm Temp.	14.4	High Alarm Temp.	30.9
Tunnel High Alarm	31.0	Target S.Pressure	29
Min Level	5	Max Level	5

## 3.2 Minimum/Maximum Level

- ➡ **IMPORTANT:** Before setting Min/Max level, go through and set up the Device Settings, especially the **ventilation levels**.

Once you have entered the ventilation levels, use the Min/Max to select the range of levels to apply to your situation. Typically, Platinum Touch/One increases the minimum ventilation level as litter conditions deteriorate and the birds require greater amounts of fresh air. You can also restrict the maximum level to prevent excess airflow on young birds.

- ➡ Go to Control > **Control Mode** to select the minimum ventilation method:
  - By Day and By Days with Curve
  - By Time
  - Soft Min / Max
  - By Weight

### 3.2.1 BY DAY AND BY DAYS WITH CURVE

- **By Day** operates according to each day's minimum and maximum values, the following defined day is reached.
- **By Days with Curve** generates an incremental increase/decrease between the defined days.

Day	Min Level	Max Level
1	1	30
0	0	0
0	0	0
0	0	0
0	0	0
0	0	0
0	0	0
0	0	0
0	0	0
0	0	0
0	0	0
0	0	0
0	0	0
0	0	0
0	0	0
0	0	0

Day	Min Level	Max Level
1	1	30
0	0	0
0	0	0
0	0	0
0	0	0
0	0	0
0	0	0
0	0	0
0	0	0
0	0	0
0	0	0
0	0	0
0	0	0
0	0	0
0	0	0
0	0	0

- Define:
  - Day: Set growth day
  - Minimum Level: Set minimum ventilation level for controller
  - Maximum Level: Set maximum ventilation level for controller

### 3.2.2 BY TIME

From	Min Level	Max Level
00:00	1	30
00:00	0	0
00:00	0	0
00:00	0	0
00:00	0	0
00:00	0	0
00:00	0	0
00:00	0	0
00:00	0	0
00:00	0	0
00:00	0	0
00:00	0	0
00:00	0	0
00:00	0	0
00:00	0	0

- Define:
  - From: Set time of day (hh:mm) in 24-hour format.
  - Minimum Level: Set minimum ventilation level for controller.
  - Maximum Level: Set maximum ventilation level for controller.



### 3.2.3 SOFT MIN / MAX

Min / Max Vent Level			
Soft Min / Max			
Day	Min Soft	Min Level	Max Level
1	1	1	20
5	1	2	30
10	1	4	30
20	1	6	30
0	0	0	0
0	0	0	0
0	0	0	0
0	0	0	0
0	0	0	0
0	0	0	0
0	0	0	0
0	0	0	0
0	0	0	0

#### 1. Define:

- **Day:** Set the growth day.
- **Min Soft:** Set the minimum ventilation level for when temperature drops below heat temperature.
- **Minimum Level:** Set the minimum ventilation level for when the temperature is above heat temperature.
- **Maximum Level:** Set the maximum ventilation level for the controller.



2. If required, click and set the parameters.

#### 3.2.3.1 Soft Min/Max Level Help | Set Definitions

⌵ ↺ ✕
**Min Max Level - Settings**

**Min Max Soft Min. Settings**

Difference Below Heat For Soft Minimum 5.6

Temp Choice For Soft Minimum Inside ▾

#### • Define:

- **Difference Below Heat for Soft Minimum:** Set the degree of difference from the heat temperature (set in [Temperature Curve](#)) to switch the minimum level from Min. to Soft Min.
- **Temp Choice for Soft Minimum:** Select inside/outside/attic temperature to control Minimum Level changes. The minimum level adjusts towards the

Soft Min as this temperature falls. Above the heat temperature, the minimum level is at the Min setting.

As temperature rises, **INSIDE** and **ATTIC** stay at lowest ventilation level reached until average temperature gets to the heat setting, and then changes instantly. With the **OUTSIDE** selection, the minimum ventilation level increases gradually as temperature rises to the heat setting. This means inside and attic soft min vent choices to latch to the lowest level reached as long as the temperature remains below the heat setting.

### 3.2.4 BY WEIGHT

The By Weight option enables controlling the minimum air flow depending on the number of birds, their weight, and the current outside temperature. When using the Weight option, Platinum Touch/One takes several parameters and calculates the air speed, level of ventilation and cycle time needed to supply the required volume. As opposed to the other ventilation methods, the Weight option is dynamic, with the ventilation changing according to the current parameters (quantity of air required, weight of birds and number of birds, outside air temperature). In addition, Ventilation By Weight sends out an alarm if the current ventilation is below the minimum required level.

To set up the Weight Option:

1. In System > Setup, enable Minimum Ventilation.
2. In System > Temp Definition, define at least one temperature sensor as Outside.
3. In System > Fan Air Capacity, define the air capacity / hour.
4. In System > Scale Setting> General, select the curve.
5. In System > Bird Curve, define the growth days and weights as required.
6. In Control > Control Mode > Min. Max Level Control menu, select **By Weight**.
7. In Control > Min/Max Level, set the parameters as required.

Min / Max Vent Level By Weight				
Day	Min Level	Air Per Kg/Lb		Max Level
		Cold Air Per	Warm Air Per	
1	1	0.5	1.5	16
3	1	0.5	1.5	18
6	1	0.5	1.5	21
0	0	0.0	0.0	0
0	0	0.0	0.0	0
0	0	0.0	0.0	0
0	0	0.0	0.0	0
0	0	0.0	0.0	0
0	0	0.0	0.0	0
0	0	0.0	0.0	0

- **Day:** Set growth day.
- **Minimum Level:** Set the minimum level of ventilation.

- **Air Per Kg/Lb:** Volume of air per kilogram/pound per hour per bird.
  - Cold Air Per: Volume of air supplied when the outside temperature goes down to the Cold Temperature parameter (see the following section).
  - Warm Air per: Volume of air supplied when the outside temperature reaches Warm Temp. – Diff Below Heat (see the following section).

*NOTE As the level rises between days (for example between day 6 and day 10 in the screen above), the air volume rises proportionally each day, once a day. For example, on Day 7, the Cold Air per Kg/Lb rises to 0.65; on Day 8, 0.8 and so on.*









- **Maximum Level:** Set the maximum level of ventilation.

8. If required, click  and set the parameters.

9. In Management > **Inventory**, type the number of birds.

- Min/Max Level By Weight Help | Set Definitions Version 7.18 and Below
- Min/Max Level By Weight Help | Set Definitions Version 7.19

### 3.2.4.1 Min/Max Level By Weight Help | Set Definitions Version 7.18 and Below

Min Max Level - Settings			
Min Max Weight Settings			
Warm Temperature - Diff. Below Heat	0.0 	Cold Temp.	0.0 
Air Change	0.40 	Fan Cycle Time (Sec., 0-Manual)	300 
Min On Time In Vent Cycle (Sec.)	60 	Min Off Time In Vent Cycle (Sec.)	60 
Air Change By Humidity/Co2 %	0 	Air Per Weight Curve Mode	2 

- **Define:**
  - **Warm Temperature – Difference Below Heat:** Differential below the heat temperature (refer to [Temperature Curve](#)) that defines outside temperature as Warm in the Soft Min/Max table. For example, if the Heat Temperature is 78° F, Warm Temp. – Diff Below Heat is 2.0, than the outside temperature is defined as warm at 76° F.
  - **Cold Temperature:** Outside temperature (or below) at which **Air per Kg/Lb. (Cold)** capacity is reached.

*NOTE When the outside temperature is between the Warm and Cold Temperature, the flow rate is calculated at a proportional rate.*

- **Air Change:** As the temperature rises from the Cold Temperature parameter to the Heat Temperature (or drops from the Heat Temperature to the Cold Temperature parameter), the minimal air volume rises/falls proportionally. Air Change defines the minimal change in air temperature that must take place to cause a change in the air supply.

- **Fan Cycle Time:** The total amount of time that the fans operate while operating under Minimum Ventilation. During this time, the fans supply the required volume of air at the minimum ventilation level required. Platinum Touch/One adjusts the minimum ON time and OFF time as needed. If the fans cannot supply the required volume at a particular level of ventilation, Platinum Touch/One automatically adjusts the minimum ventilation level.
- **Minimum ON Time in Vent Cycle:** The minimum amount of time that the fans operate during a ventilation cycle. Platinum Touch/One adjusts the actual fan time as needed.
- **Minimum OFF Time in Vent Cycle:** The minimum amount of time that the fans do not operate during a ventilation cycle. Platinum Touch/One adjusts the actual fan time as needed.

As the temperature rises, the actual Minimum OFF Time decreases until it reaches the minimum time; only then does the Minimum On Time begin to rise.

*NOTE If the temperature goes above the Band Temperature, Power Ventilation begins and times are adjusted accordingly.*

- **Air Change By Humidity/CO2%:** As the humidity/CO2 levels rise above the levels specified in [Humidity Treatment](#) and [CO2 Treatment](#), the minimal air volume rises proportionally. Air Change By Humidity/CO2% defines the minimal change in these levels that must take place to cause an increase in the air supply.
- **Air Per Weight Curve Mode:** By default, Air per Kilo/Lb. has two data points: cold temperature and warm. If desired, the user can add an additional intermediate data point which is between the two default points. This point determines the quantity of air to be distributed when the temperature reaches the midpoint between the cold and warm temperatures.

*NOTE In a three-point curve, the intermediate value must be between the cold and warm value in each line.*



### 3.2.4.2 Min/Max Level By Weight Help | Set Definitions Version 7.19

Version 7.19 has an additional parameter, Medium Temp, which enables setting up a more accurate temperature curve in Air by Weight. By default, the curve is determined by the Air per Kg/Lb Cold and Warm Temperatures. Medium Temp adds an additional (user-defined) point to the curve.









To add the Medium Temp point:

1. Configure Air by Weight as shown in Min/Max Level By Weight Help | Set Definitions Version 7.18 and Below, page 31.
2. Go to Control > Min/Max > Help and configure the parameters.
3. In the Help screen, define the Air per Weight Curve Mode:
  - Using the number pad keys to define the mode as 2 or 3.
    - If set to 2, the Medium Temp parameter is disabled.
    - If set to 3, define the Middle Temp parameter.

### Min Max Level - Settings



#### Min Max Weight Settings

Warm Temperature - Diff. Below Heat	0.0 	Medium Temperature	0.0 
Cold Temp.	0.0 	Air Change	0.40 
"Fan Cycle Time (Sec., 0-Manual)"	300 	Min On Time In Vent. Cycle (Sec.)	60 
Min Off Time In Vent. Cycle (Sec.)	60 	Air Change By Humidity/CO2/Ammonia %	0 
Air Per Weight Curve Mode	3 		

- It can be no lower than the Cold Temperature.
- It can be no higher than the Warm Temperature minus Warm Temp. – Diff below Heat differential.
- Go to the Control Menu screen, re-enter the Mini/Max screen, and the Medium Weight parameter appears.

### Min/Max Vent. Levels

By Weight

Day	Min Level	Air Per Kg/Lb			Max Level
		Cold Air Per	Middle	Warm Air Per	
1	1	0.8	0.9	1.0	30
0	0	0.0	0.0	0.0	0
0	0	0.0	0.0	0.0	0
0	0	0.0	0.0	0.0	0
0	0	0.0	0.0	0.0	0
0	0	0.0	0.0	0.0	0
0	0	0.0	0.0	0.0	0
0	0	0.0	0.0	0.0	0
0	0	0.0	0.0	0.0	0
0	0	0.0	0.0	0.0	0
0	0	0.0	0.0	0.0	0
0	0	0.0	0.0	0.0	0

### 3.3 Soft Maximum Levels

Platinum Touch Version 7.24 supports Soft Maximum Levels.

- Introduction
- Soft Minimum Screens
- Soft Min Max Levels

### 3.3.1 INTRODUCTION

The Soft Maximum Level screen enables determining the maximum ventilation level according to the outside temperature. Soft Maximum Level works with all minimum and maximum level described in Min/Max Level.

- Cold Max refers to the maximum amount air to be supplied depending on the birds age and the cold outside temperature. The Cold Max temperature is set by subtracting the “Diff below heat for cold max” (defined in the Settings) from the Heat parameter.
- Warm Max refers to the maximum amount air to be supplied depending on the birds age and the warm outside temperature. The Warm Max temperature equals the Temperature Curve Heat parameter.
- Between these points, Platinum Touch determines the ventilation according to a curve.

*NOTE If the outside temperature sensor fails, the maximum level equals the warm maximum.*

➡ In Temperature Definition, page 130 designate at least one temperature sensor as an outside temperature sensor.

To enable Soft Maximum Levels

1. Go to Control > Control Mode.

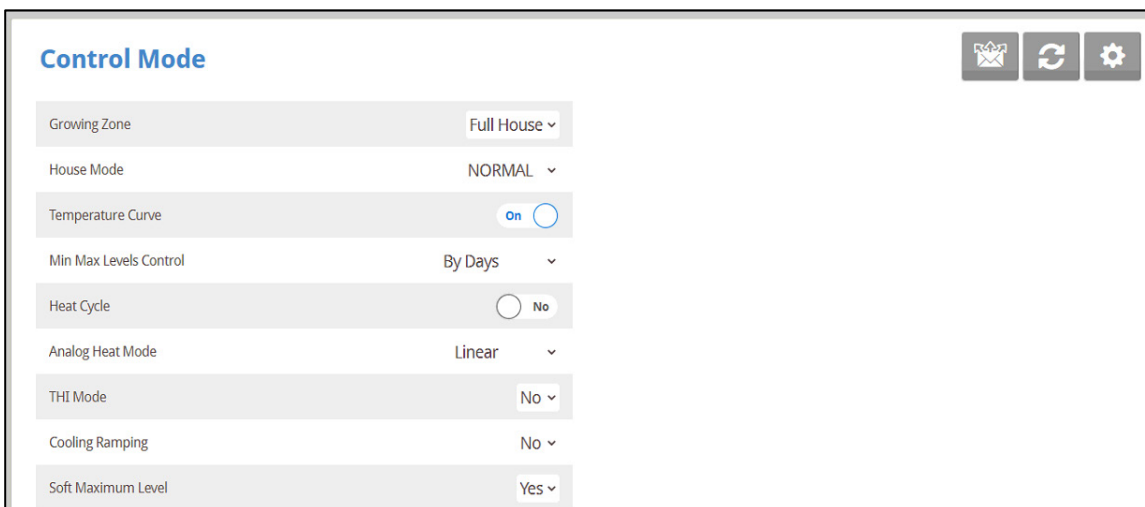

The screenshot shows the 'Control Mode' settings interface. It features a title bar with three icons (envelope, refresh, gear) on the right. Below the title, there are several settings rows, each with a label on the left and a value or control on the right. The 'Soft Maximum Level' setting is highlighted with a light blue background and is set to 'Yes'.

Setting	Value/Control
Growing Zone	Full House ▾
House Mode	NORMAL ▾
Temperature Curve	On <input checked="" type="radio"/>
Min Max Levels Control	By Days ▾
Heat Cycle	<input type="radio"/> No
Analog Heat Mode	Linear ▾
THI Mode	No ▾
Cooling Ramping	No ▾
Soft Maximum Level	Yes ▾

2. Set Soft Maximum Level to YES.

3. Go to Control > Min/Max Levels and define the minimum/maximum ventilation levels.

- Cold Max Range: From the Minimum Level to Warm Max. Default 30
- Warm Max Range: From Cold Maximum Level to 30. Default 30

4. Go to Control > Mim/Max Levels > Settings.

**Min Max Level - Settings**

**Min Max Soft Min. Settings**

Difference Below Heat For Soft Minimum 5.6

5. Define:

- **Diff below heat-off to Cold Max:** Below this temperature, ventilation operates according to the Cold Max setting. Define the Heat Off parameter in Temperature Curve, page 20.

3.3.2 SOFT MINIMUM SCREENS

- By Days and By Soft Days Curve

**Min/Max Vent. Levels**  
By Day

Day	Min Level	Cold Max	Warm Max
1	1	5	10
5	1	7	12
15	2	9	15
0	0	0	0
0	0	0	0

- By Time

**Min/Max Vent. Levels**  
By Time

From	Min Level	Cold Max	Warm Max
05:00	1	5	10
07:00	1	6	11
09:00	2	8	13
00:00	0	0	0
00:00	0	0	0

- Soft Minimum: Refer to Soft Minimum Cold Max.
- By Weight

**Min/Max Vent. Levels**  
By Weight

Day	Min Level	Air Per Kg/Lb		Cold Max	Warm Max
		Cold Air Per	Warm Air Per		
1	1	0.8	1.0	5	8
5	1	0.9	1.1	7	9
15	2	1.2	1.4	9	11
0	0	0.0	0.0	0	0

### 3.3.3 SOFT MIN MAX LEVELS

In this function, the user defines minimum and maximum ventilation levels for cold and warm temperatures, enabling Platinum Touch to adjust the ventilation at both cold and warm temperatures.

1. Define the screen's cold and warm minimum/maximum levels.

Min/Max Vent. Levels				
Soft Min/Max				
Day	Cold Min	Warm Min	Cold Max	Warm Max
1	1	1	5	10
5	1	1	7	12
15	1	2	9	15
0	0	0	0	0
0	0	0	0	0

2. Go to Settings.

Min Max Level - Settings	
<b>Min Max Soft Min. Settings</b>	
Difference Below Heat For Soft Minimum	5.6
Temp Choice For Soft Minimum	Inside
Diff below heat for Cold Min	5.6

3. Define:

- **Differential Below Heat for Cold Minimum/Difference Below Heat For Soft Minimum:** Below this temperature, ventilation operates according to the Cold Min setting. Define the Heat Off parameter in Temperature Curve, page 20. Range: 0 - 99°. Default 10°
  - **Reference Temperature For Cold Min/Temperature Choice For Soft Minimum:** Select inside/outside/attic temperature to control minimum level changes.
- ➡ In Temperature Definition, page 130 designate at least one temperature sensor as an outside temperature, inside, or attic sensor.
- **Diff Below Heat-Off to Cold Max/Diff below heat for Cold Min:** Below this temperature, ventilation operates according to the Cold Max setting. Define the Heat Off parameter in Temperature Curve, page 17.
  - **Example:**
    - Heat: 80°
    - Heat Off Temperature: 75°
    - Diff below Heat-Off to Cold Min: 15°
    - Diff below Heat-Off to Cold Max: 5°



On Day 1, at 60° or lower the minimum ventilation is Level 1. As the temperature rises to 70°, the maximum ventilation rises to Level 5. If the temperature rises above 80°, the ventilation will operate between Levels 11 and 30.

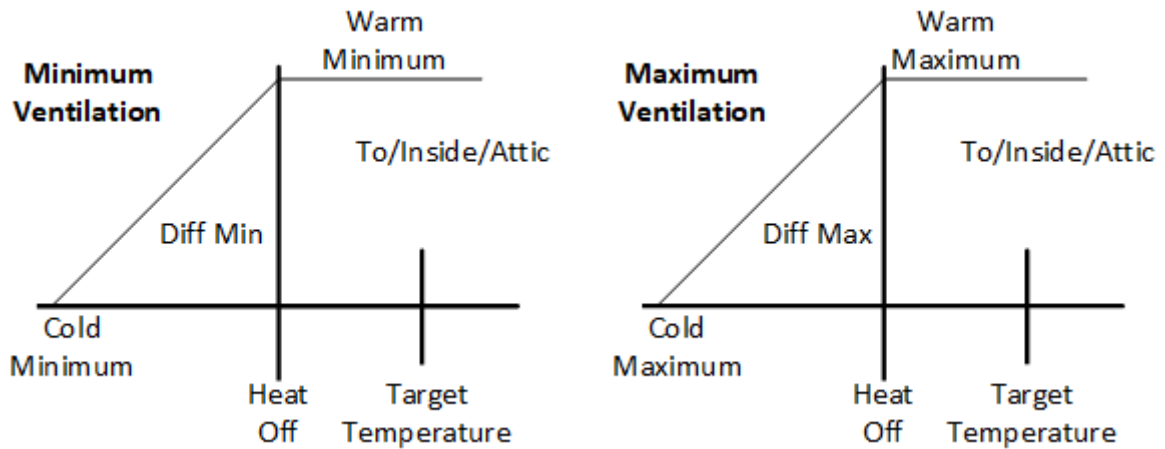

### 3.4 Introduction to Humidity, Ammonia, and CO2 Treatment

Platinum Touch/One provides various options to controlling the humidity, CO2, and ammonia levels.

- **None:** No treatment is provided.
- **Level:** Ventilation levels increase for a designated amount of time.
- **Tunnel or Exhaust Fan:** A designated fan turns on for a designated amount of time. The amount of air blown into the house is greater than that provided by an increase in ventilation level.
- **Increase in air / Weight:** The total amount of air that fans need to provide increases by a user defined amount. Fan stays on until CO2, humidity, or ammonia levels fall to their defined levels. This option is only available when using Minimum Ventilation by Weight.
- **Humidity Treatment by Heat:** In cold air situations, heaters can be turned on to lower the relative humidity.

If there is a contradiction between CO2, humidity, and ammonia treatments:

- Ammonia treatment has priority over CO2 treatment.
- CO2 treatment has priority over humidity treatment.
- Increase in air / weight has priority over other treatments.
- Humidity treatment by heat takes priority over increasing the ventilation.

### 3.5 Humidity Treatment

- Humidity Screen Main Screen
- Humidity Treatment Help | Set Definitions

#### 3.5.1 HUMIDITY SCREEN MAIN SCREEN

Humidity treatment forces an increase in ventilation level when the humidity is too high. It holds the increase for 'Duration Seconds' and checks back after 'Interval Minutes' for another increase. After the duration, the ventilation level comes back down automatically.

Humidity Treatment			
Day	Humidity	Delay (Min.)	Duration (Sec.)
1	70	2	30
5	70	2	40
8	75	2	30
11	75	2	40
15	80	2	50
18	80	2	0
0	0	0	0

1. In *System > Sensors > Analog*, designate one or two sensors as indoor humidity sensors (outdoor sensor is for information only). When using more than one sensor, Platinum Touch/One begins treatments based on the average.

2. In *Control > Humidity Treatment* define:

- **Day:** Set the growth day. You can set multiple programs for same day (maximum number of programs: 20)
- **Humidity:** Set the humidity level at which to begin treatment.
- **Delay (Min):** Set the amount of time the controller pauses before ventilating.
- **Duration (Sec):** Set the number of seconds the controller maintains the increased level of ventilation

3. Set the [Humidity Sensor Alarm](#).

4. If required, click  and set the parameters.

### 3.5.2 HUMIDITY TREATMENT HELP | SET DEFINITIONS

**Humidity Treatment - Settings**
✉️ ↻ ✕

#### Humidity Treatment

Humidity Band (%) 2 

Humidity Treatment Below Heat  No

Humidity Treatment By Level ▾ ▾

#### Humidity Treatment By Heaters

Humidity Treatment By Heater  No Outside Temp. Treatment By Heaters 0.0 

Diff To Stop Treatment By Heaters 0.0 

- Define:
  - **Humidity Band (%)**: Set the differential band for Humidity Treatment. For example, if the humidity target is 75% and the band is 2%, treatment begins at 77%.
  - **Humidity Treatment below Heat**: Select YES or NO for allowing Humidity Treatment when heaters are operating (set in [Temperature Curve](#)).
  - **Humidity Treatment By**: This parameter designates the method used when humidity or CO2 treatment begins. Normally, this parameter is relevant only when minimum ventilation is running. When a treatment is required, select the method to be employed:
    - **None**: Disables the treatment.
    - **Level**: Increases the ventilation level when a treatment is required.

*NOTE When employing [Ventilation by Weight](#), the controller increases the cycle time or the level, depending on the particular settings.*

- **Humidity Treatment by Heaters**: This parameter enables using the heaters to lower the relative humidity. If enabled, define:
  - **Outside Temp Treat by Heaters**: A differential from the target temperature; when the outside temperature reaches this point, heaters turn on and remain on for the duration time.
  - **Diff to Stop Treatment by Heaters**: A differential from the target temperature; when the inside temperature reaches this point, heaters turn off and remain off for at least the duration time. This number can be positive or negative.
- ➡ **Humidity Treatment by Heater** requires designating at least one thermometer as an outside thermometer (refer to [Temperature Definition](#), page 130).

*NOTE If the heaters are operating because of the interior temperature, Humidity Treatment by Heater is disabled.*

*NOTE Broiler and Breeder Modes support Humidity Treatment by Heaters.*

## 3.6 CO2 Treatment

- CO2 Main Screen
- CO2 Treatment Help | Set Definitions

### 3.6.1 CO2 MAIN SCREEN

CO2 treatment forces an increase in ventilation level when the CO2 level is too high. It holds the increase for 'Delay Seconds' and checks back after 'Interval Minutes' for another increase. After the duration, the ventilation level may come back down automatically. If during treatment, the CO2 level drops below the **Stop Value** parameter, the ventilation level automatically returns to that level used before CO2 treatment was initiated.

- Version 7.19 and below support one CO2 sensor.
- Version 7.20 supports two CO2 sensors. If two sensors are installed, the Main Screen displays the average.

CO2 Treatment				
Day	PPM		Delay (Sec.)	Duration (Sec.)
	Start Value	Stop Value		
1	3,000	2,500	120	130
5	2,700	2,200	120	150
9	2,500	2,000	120	180
0	100	0	0	0
0	100	0	0	0
0	100	0	0	0
0	100	0	0	0
0	100	0	0	0
0	100	0	0	0
0	100	0	0	0
0	100	0	0	0

1. In *System > Sensors > Analog*, designate one sensor as a CO2 sensor.

2. In *Control > CO2 Treatment* define:

- **Day:** Growth day. You can set multiple programs for same day (maximum number of programs: 20)
- **Start Value:** CO2 value at which to begin treatment
- **Stop Value:** CO2 value at which to end treatment
- **Delay:** Number of seconds the controller pauses before ventilating
- **Duration:** Number of seconds the controller maintains the increased level of ventilation

3. Set the [CO2 Sensor Alarm](#).

4. If required, click  and set the parameters.

### 3.6.2 CO2 TREATMENT HELP | SET DEFINITIONS

The screenshot shows a settings window titled "CO2 Treatment - Settings". It is divided into two main sections. The first section, "CO2 Treatment", contains a toggle switch for "CO2 Treatment Below Heat" which is currently set to "No", and a dropdown menu for "CO2 Treatment By" which is set to "Level". The second section, "CO2 Treatment By Heaters", contains a toggle switch for "CO2 Treatment By Heaters" set to "No", a numeric input field for "Outside Temp. Treatment By Heaters" with a value of 0.0, and another numeric input field for "Diff To Stop Treatment By Heaters" with a value of 0.0.

- **Define:**
  - **CO2 Treatment below Heat:** Select **YES** or **NO** to enable CO2 treatment when heaters are operating (set in [Temperature Curve](#)).
  - **CO2 Treatment By:** This parameter designates the method used when humidity or CO2 treatment begins. Normally, this parameter is relevant only when minimum ventilation is running. When a treatment is required, select one the method to be employed:
    - **None:** Disables the treatment.
    - **Level:** Increases the ventilation level when a treatment is required.

*NOTE* When employing [Ventilation by Weight](#), the controller increases the cycle time or the level, depending on the particular settings.

- **CO2 Treatment by Heaters:**

CO2 Treatment by Heater: This parameter enables running the heaters in situations where the CO2 level is high. Typically this can happen in cold temperatures when CO2 is produced by the heaters. By increasing the heat in the house, ventilation can then be increased. If enabled, define:

- **Outside Temp Treat by Heaters:** A differential from the target temperature; when the outside temperature reaches this point, heaters turn on and remain on for the duration time.
- **Diff to Stop Treatment by Heaters:** A differential from the target temperature; when the inside temperature reaches this point, heaters turn off and remain off for at least the duration time. This number can be positive or negative.

➡ **CO2 Treatment by Heater** requires designating at least one thermometer as an outside thermometer (refer to [Temperature Definition](#), page 130).

*NOTE* If the heaters are operating because of the interior temperature only, CO2 Treatment by Heater is disabled.

## 3.7 Natural Ventilation

Natural Ventilation enables supplying the house's air requirements using the wind. Using Natural Ventilation depends on a variety of environmental and scheduling factors. While in this mode, curtains open and close based on the target temperature.

Setting up the Natural Ventilation is a multiphase process.

- How Does Natural Ventilation Work
- Preliminary Steps
- Defining Natural Conditions
- Defining Natural Operation
- Natural Programming Help | Set Definitions
- What Happens When the Controller Transitions?

### 3.7.1 HOW DOES NATURAL VENTILATION WORK

For Platinum Touch/One to switch to Natural Ventilation:

- Natural Ventilation works only during the defined growth days and daily schedule.
- The temperature inside the chicken house must be within the inside temperature band.
- The temperature outside the chicken house must be within the outside temperature band.
- If the temperature is below either of the above two parameters, ventilation switches to Minimum.
- If the temperature is above either of the above two parameters, ventilation switches to Tunnel (there is an option to remain in natural ventilation; refer to [Minimum Wind Speed for Tunnel Temp](#)).
- The wind speed must be within the wind speed band.
- The wind direction must be within the user-defined area.

*NOTE Including the wind speed and direction in Natural Ventilation calculations is optional and requires in the installation and configuration of additional equipment.*

- If the weather conditions meet the above requirements, curtains open to a calculated position based on the **difference temperature** and **minimum** and **maximum** percentage. If more air is required, the curtains adjust themselves automatically using a calculation based on the minimum and maximum curtain position. The larger the difference between the minimum and maximum openings, the larger the step.
- Any change in the curtain position takes place after the Delay Time.

### 3.7.2 PRELIMINARY STEPS

- ➡ Install a wind speed and rain detector (optional).
  - ➡ Install a wind direction sensor (optional).
1. In System > Setup > Natural Ventilation, select:

- **Level:** This option instructs the controller to run Natural Ventilation using the levels shown in *System > Levels of Ventilation > Vent and Curtain Levels*. If you choose this option, no further setup is required.
  - **Program:** This option uses the parameters listed below to determine curtain opening.
2. If you installed a wind speed and rain detector, in *System > Digital Sensors*, define the sensors accordingly.
  3. If required, in *System > Temperature Definition* designate a temperature sensor as an outside sensor.
  4. If you installed a wind direction sensor:
    - a. In *System > Sensors > Analog Sensor*, define the sensor accordingly.  
If required, calibrate the wind direction sensor (refer to Wind Direction Calibration).
    - b. In *System > Air Inlets Setup*, define each curtain's direction. When making Natural Program calculations, the controller only takes into consideration winds coming from a certain direction. Any wind whose source is outside of this area is disregarded.
- 7.18: The number entered here defines the area (the number entered  $\pm 90^\circ$ ) ([Figure 3: Wind Direction Sensor Definition](#)).
    - If you enter 90, the range is from 0 - 180°.
    - If you enter 45, the range is from 315 - 135°.

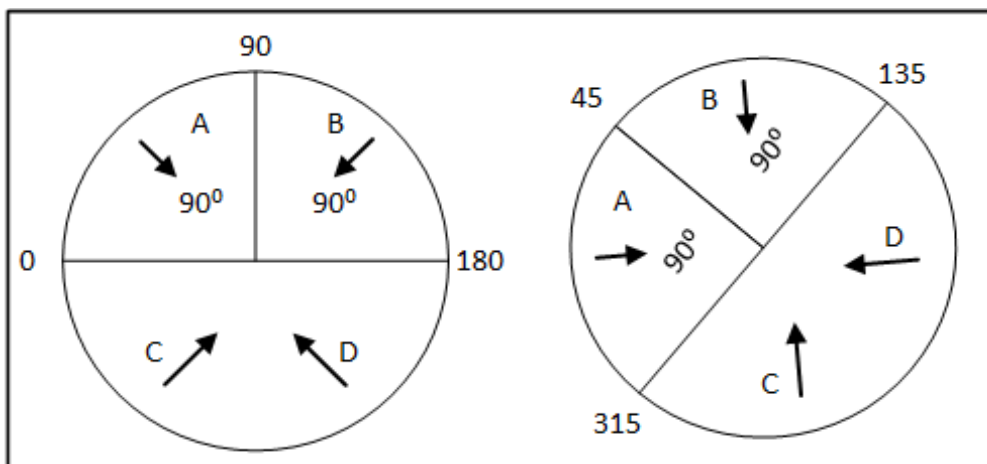

Figure 7: Wind Direction Sensor Definition (7.18)

- 7.19: The number entered here defines the area (the number entered  $\pm 20^\circ$ ) (Figure 8).
  - If you enter 90, the range is from 20 - 160°
  - If you enter 45, the range is from 335 - 115°

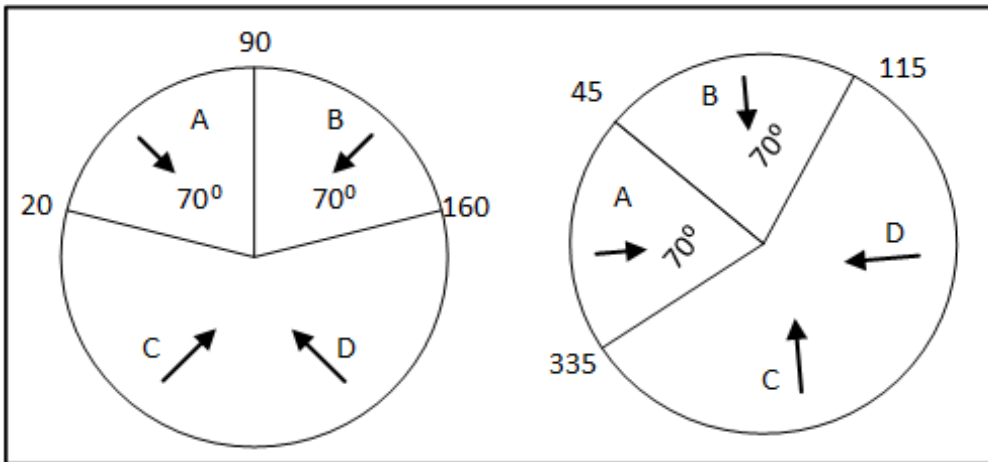

Figure 8: Wind Direction Sensor Definition (7.19)

**NOTE** In both cases, winds A or B would be factored into the calculations whereas winds C or D would not. Only calibrate the sensors if you have reason to believe that they are producing inaccurate results.

The number entered here defines the area on both sides of the sensor! Figure 7 illustrates a chicken house with four wind sensors. Sensor 1's Wind Direction parameter is defined as 45° or 90° **total**. Winds that come within this area (A) are used for Natural Programming. The controller disregards winds outside of this area (B & C).

### 3.7.3 DEFINING NATURAL CONDITIONS

- Defining Natural Operation, Version 7.18 and Below (No minimum curtain opening curve)
- Defining Natural Operation, Version 7.19 (Enables minimum curtain opening curve)

#### 3.7.3.1 Defining Natural Operation, Version 7.18 and Below

## Natural Ventilation

**Natural Entrance Conditions**

From Day <span style="float: right;">1 </span>	To Day <span style="float: right;">50 </span>
From Time <span style="float: right;">00:00 </span>	To Time <span style="float: right;">00:00 </span>
Low Outside Temperature Diff. from Target <span style="float: right;">-10.0 </span>	High Outside Temperature Diff. from Target <span style="float: right;">5.0 </span>
Min Wind Speed to Enter <span style="float: right;">2.0 </span>	Max Wind Speed to Exit <span style="float: right;">10.0 </span>
Min Speed For Tunnel Temp. <span style="float: right;">2.0 </span>	

**Natural Mode Operation**

Low Temperature Diff. from Target <span style="float: right;">1.0 </span>	High Temperature Diff. from Target <span style="float: right;">6.0 </span>
Curtain Step Size <span style="float: right;">10 </span>	Curtain Delay Between Steps (Sec.) <span style="float: right;">300 </span>



Natural Conditions define when the controller switches to Natural Ventilation.

- **Define:**
  - **From/To Day:** Sets start and end day for the Natural Program
  - **From/To Time:** Sets starting and finishing time for the Natural Program
  - **Low Outside Temperature Diff from Target:** The band below the Current Target Temperature in which Natural Programming operates (**outside temperature**). Range: -20 to +20° C.
  - **High Outside Temperature Diff from Target:** The band above the Current Target Temperature in which Natural Programming operates (**outside temperature**). Range: -20 to +20° C.
  - **Minimum Wind Speed to Enter:** Sets the wind speed required to enter Natural Program.
  - **Maximum Wind Speed to Exit:** Sets wind speed required to exit Natural Program.
  - **Minimum Wind Speed for Tunnel Temperature:** When the unit is in Natural Mode, if the temperature rises above the Tunnel Temperature, Platinum Touch/One switches to Tunnel mode unless the wind speed is **above** the speed set here.







*NOTE The above three parameters require installing and configuring a wind speed sensor.*

### 3.7.3.2 Defining Natural Operation, Version 7.19

Version 7.19 enables defining a curve for the minimum curtain opening.

- Under Natural Operation, define the:
  - **Min Curtain Position (1st Day):** Set the minimum curtain position on first growth day.
  - **Min Curtain Position (Last Day):** Set the minimum curtain position on last growth day.

The differential between these parameters defines the curve that sets the minimum curtain position for each day.

Natural Mode Operation			
Low Temperature Diff. From Target	1.0 	High Temperature Diff. From Target	6.0 
Curtain Step Size	10 	Curtain Delay Between Steps (Sec.)	300 
Min. Curtain Position 1st day	15 	Min. Curtain Position Last day	15 
Max Curtain Position	100 	Wind & Rain Effect	<input type="radio"/> No

### 3.7.4 DEFINING NATURAL OPERATION

#### Natural Ventilation

From Time	00:00	To Time	00:00
Low Outside Temperature Diff. from Target	-10.0	High Outside Temperature Diff. from Target	5.0
Min Wind Speed to Enter	2.0	Max Wind Speed to Exit	10.0
Min Speed For Tunnel Temp.	2.0		

#### Natural Mode Operation

Low Temperature Diff. from Target	1.0	High Temperature Diff. from Target	6.0
Curtain Step Size	10	Curtain Delay Between Steps (Sec.)	300
Min Curtain Position	15	Max Curtain Position	100
Wind & Rain Effect	<input type="checkbox"/> No		

Natural Operation defines how the controller functions in Natural Ventilation.

- **Define:**
  - **Low Temperature Diff from Target:** The band below the Current Target Temperature in which Natural Programming operates (**inside temperature**).
  - **High Temperature Diff from Target:** The band above the Current Target Temperature in which Natural Programming operates (**inside temperature**)
  - **Curtain Step Size:** Set the curtain to open by this amount at each level (%).
  - **Curtain Delay Between Steps (sec.):** To prevent excess switching between steps, set a delay time.
  - **Minimum Curtain Position:** Set the minimum curtain open position.
  - **Maximum Curtain Position:** Set the maximum curtain open position.
  - **Wind and Rain Effect:** Enables Platinum Touch/One to consider additional parameters (found in the Help) when calculating the maximal curtain opening.

### 3.7.5 NATURAL PROGRAMMING HELP | SET DEFINITIONS

#### Natural Ventilation - Settings

##### Natural Entrance Conditions

Enable Natural in Tunnel:	<input type="radio"/> No	Wind Gust Delay Time (Sec.)	60
Disable Stir Fan above Wind Speed:	6.0	Min Time in any Vent Mode (Min.)	10
Use Tunnel As Natural Curtain:	<input type="radio"/> No		

##### Wind & Rain Effect

Low Wind Speed:	4.0	High Wind Speed:	8.0
-----------------	-----	------------------	-----

#### 1. Define the Natural Entrance Conditions:

- **Enable Natural In Tunnel:** Enables using Natural Ventilation definitions when in Tunnel mode.
- **Wind Gust Delay Time:** Set the delay time for recalculating curtain movement if the wind speed changes.
- **Disable Stir Fan Above W. Speed:** Above this wind speed, Stir Fans cease to operate when in Natural Programming.
- **Min. Time in Any Vent Mode (min):** Minimal amount of time that the controller waits before changing into Natural Programming (from Minimum Ventilation or Tunnel Mode). Similarly, the controller remains in Natural Ventilation for at least this time.
- **Use Tunnel As Natural Curtain:** Use tunnel curtains when in Natural Programming. When disabled, curtains remain closed.

#### 2. Define the Natural Mode Operation:

- **Low Wind Speed:** Below this speed, curtains open completely. This number must be higher than the Minimum Wind Speed to Enter.
- **High Wind Speed:** Above this wind speed, the controller lowers the curtain maximum opening percentage to this point.

*NOTE Between these levels, the controller opens the curtain based on a curve.*

- **Low Wind Speed With Rain:** If there is a rain detector, curtains open completely when there is rain.
- **High Wind Speed With Rain:** If there is a rain detector, curtains close completely when there is rain.

*NOTE Between these levels, the controller opens the curtain based on a curve.*

### 3.7.6 WHAT HAPPENS WHEN THE CONTROLLER TRANSITIONS?

When the controller transitions to or from Natural Ventilation the following changes take place:

- **Side/Power > Natural:** Fans stop, curtains open to the calculated position and finally the side inlets close.
- **Tunnel > Natural:** Fans stop, curtains open to the calculated position. When the curtains reach their maximum opening position, the tunnel closes (unless the tunnel mode operates to open in natural Mode).
- **Natural > Side/Power:** The controller automatically calculates most suitable Power Ventilation Level, depending on the Target Temperature and current Inside Temperature.
- **Natural > Tunnel:** The controller automatically calculates the most suitable ventilation level depending on the Target Temperature and current Inside Temperature (minimum or tunnel).

## 3.8 Static Pressure

Set target parameters for attic, minimum, and tunnel ventilation.

- ➔ In System > **Setup**, enable a static pressure unit.
- ➔ Refer to Static Pressure Calibration and Static Pressure.
  - Static Pressure Method
  - Disabling the Static Pressure Sensor
  - Static Pressure Help | Set Definitions
  - Multi Stage Tunnel Curtains

### 3.8.1 STATIC PRESSURE METHOD

- Attic Static Pressure
- Minimum Ventilation Static Pressure
- Tunnel Ventilation Static Pressure

#### 3.8.1.1 Attic Static Pressure

Static Pressure		
Attic Ventilation	Min Ventilation	Tunnel Ventilation
Target S.Pressure	12	
S.Pressure Band	10	

- **Define:**
  - **Target Static Pressure:** Set the required static pressure when in attic mode.
  - **Static Pressure Band:** Set the required band for attic ventilation mode.

### 3.8.1.2 Minimum Ventilation Static Pressure

The screenshot shows the 'Static Pressure' control interface. At the top, there are three tabs: 'Attic Ventilation', 'Min Ventilation' (which is selected and highlighted in blue), and 'Tunnel Ventilation'. In the top right corner, there are three icons: a map, a refresh symbol, and a settings gear. Below the tabs is a table with five rows, each representing a different static pressure parameter and its current value with an edit icon.

Parameter	Value
S.Pressure At Low Temp.	29
S.Pressure At High Temp.	20
Low S.Pressure Alarm	5
High S.Pressure Alarm	39
S.Pressure Band	10

- **Define:**
  - **Static Pressure at Low Temperature:** Set desired static pressure for **low outside** temperature conditions. Be sure that there is proper airflow at this setting.
  - **Static Pressure at High Temperature:** Set desired static pressure for **high** temperature conditions. Normally this pressure is lower to obtain a larger air inlet opening.

*NOTE Controller interpolates between the LOW and HIGH Temperature. If Static Pressure exists, it is controlled by the outside temperature sensor, otherwise by the average temperature.*

- **Low Static Pressure Alarm:** Set alarm for low static pressure. If you disable it by setting zero, the Platinum Touch/One warns you and enters a record in the Table of Events.
- **High Static Pressure Alarm:** Set alarm for high static pressure.
- **Static Pressure Band:** Set desired band for the target pressure.

### 3.8.1.3 Tunnel Ventilation Static Pressure

The screenshot shows the 'Static Pressure' control interface. At the top, there are three tabs: 'Attic Ventilation', 'Min Ventilation', and 'Tunnel Ventilation' (which is selected and highlighted in blue). In the top right corner, there are three icons: a map, a refresh symbol, and a settings gear. Below the tabs is a table with four rows, each representing a different static pressure parameter and its current value with an edit icon.

Parameter	Value
Target S.Pressure	20
Low S.Pressure Alarm	5
High S.Pressure Alarm	39
S.Pressure Band	10

- **Define:**
  - **Target Static Pressure:** Set the required static pressure for Tunnel Ventilation Mode.
  - **Low Static Pressure Alarm:** Set the alarm for low static pressure.

- **High Static Pressure Alarm:** Set the alarm for high static pressure.
- **Static Pressure Band:** Set the required band for pressure in tunnel ventilation mode.

### 3.8.2 DISABLING THE STATIC PRESSURE SENSOR

To disable the static pressure sensor:

1. Go to System > **Setup**.
2. Set the Static Pressure Unit to **None**.

The main screen stops:

- displaying the pressure
- displaying High Pressure and Pressure Sensor Failure alarms

*NOTE If either of these alarms were active before disabling the sensor, the main screen continues to display the alarms. Reset the alarms one time to cease the display.*

### 3.8.3 STATIC PRESSURE HELP | SET DEFINITIONS

Static Pressure - Settings			
Static Pressure			
Wind Gust Delay Time (Sec.)	10	S.Pressure During Tunnel	Yes <input type="radio"/>
Transitional Tunnel	<input type="radio"/> No	Minimum Ventilation Using	Vent
Low Incoming Temp(Diff. To Target)	-13.9	High Incoming Temp(Diff. To Target)	-5.6
Emergency S.Pressure Delay (Sec.)	60	Curtain Position In Emergency S.Pressure (%) (0-Disabled)	100
Low S.Pressure Alarm Min Level (MinVent)	0	Low S.Pressure Alarm Min Level (Tunnel)	0
Time To Produce S.Pressure (Sec.)	10	Attic Advance Opening Time (Sec.)	0

- **Define:**
  - **Wind Gust Delay Time (sec):** Set length of time in seconds before starting Static Pressure control after an unexpected change in air pressure.
  - **Static Pressure During Tunnel:** Select YES or NO for using Static Pressure control when in Tunnel mode.
  - **Transitional Tunnel:** Select YES or NO for using tunnel curtains when static pressure is high and vents are already at 100%.
  - **MinVent Using:** Select VENT or TUNNEL to control static pressure when in minimum ventilation.
  - **Incoming Air Low Temperature (Deg):** Define low temperature for static pressure control.
  - **Incoming Air High Temperature (Deg):** Define high temperature for static pressure control.
  - **Emergency Static Pressure Delay (sec):** Set length of time in seconds before initiating an emergency opening when pressure exceeds high alarm setting.
  - **Curtain Position in Emergency Static Pressure % (0 – Disable):** Set the required curtain position (in percentage) when an emergency pressure event occurs.

- **Low Static Pressure Alarm Minimum Level (MinVent):** Below this level, the controller ignores low static pressure alarms when in minimum ventilation.
- **Low Static Pressure Alarm Minimum Level Low S.P. Alarm Min. Level (Tun.):** Below this level, the controller ignores low static pressure alarms while in tunnel mode.
- **Time to Produce Static Pressure (sec):** Enter the length of time to reach target pressure when minimum ventilation fan cycle is on.
- **Attic Advance Opening Time (sec):** Define the amount of time for the attic inlets to open before minimum vent cycling fans turn on.

### 3.8.4 MULTI STAGE TUNNEL CURTAINS

When in static pressure mode and employing multiple tunnel curtains, Platinum Touch/One can open the curtains in sequence. Opening the tunnel curtains commences when the target static pressure is reached and the controller signals to the tunnel machine to operate the curtains. Platinum Touch/One opens the first tunnel curtain (as defined in the relays) to the user defined level. If additional ventilation is required, the second tunnel curtain opens. This process continues for each defined curtain.

As pressure falls, the process is reversed; curtains close in progression starting with the last curtain.

To set up Multi Stage Tunnel Curtains:

1. In System > [Relay Layout](#) define more than one relay as tunnel curtain (open and close).
2. In System > Levels of Ventilation > Vent & Curtain Levels, define the opening levels for each curtain.
3. In Static Pressure > Tunnel Ventilation, define the target pressure.

## 3.9 Cool Pad

This menu sets the cool pad operating conditions.

- Cool Pad, Version 7.21 and Below
- Cool Pad, Version 7.22 and Above

### 3.9.1 COOL PAD, VERSION 7.21 AND BELOW

- Cool Pad, Main Screen
- Cool Pad Help | Set Definitions

#### 3.9.1.1 Cool Pad, Main Screen

*NOTE Cool Pads only operate when the controller is in tunnel mode. For example, if the cool pad is set to run at Level 8 and the tunnel mode begins at level 10, the cool pad remains inoperative.*

Cool Pad						
Day	Start Time	End Time	Tunnel Diff	To Humidity	On (Sec.)	Off (Sec.)
1	05:00	20:00	2.0	60	10	220
1	06:30	19:00	6.0	60	35	180
1	06:30	18:00	7.0	80	40	180
0	00:00	00:00	0.0	0	0	0
0	00:00	00:00	0.0	0	0	0

1. In *System > Relay Layout*, define relays as Cool Pad.









2. Go to *Control > Cool Pad*.

3. Define:

- **Day:** Set the growth day in this field.
- **Start Time:** The cool pad begins operating at this time.
- **End Time:** The cool pad ceases to operate at this time.
  - It is possible to set multiple start and stop times for a single day.
  - In the screen above, growth day jumps from day 1 to day 5, the cool pad continues to work according to day 1 settings from growth day 1 through growth day 5.
- **Tunnel Diff:** Set the band above the target temperature so that the cool pad begins to operate at this temperature.
- **To Humidity:** Set the maximum allowed humidity before stopping the cool pad.
- **On Sec:** Set the maximum on time for each cycle of cool pad operation.
- **Off Sec:** Set the minimum off time for each cycle of cool pad operation.

4. If required, click  and set the parameters.

### 3.9.1.2 Cool Pad Help | Set Definitions

Cool Pad - Settings			
Cool Pad			
Temperature Band	1.1 	Humidity Band (%)	2 
Diff. Between Cool Pads Stage	0.0 	Cool Pad-1 Min Level To Operate	1 
Cool Pad-2 Min Level To Operate	1 	Cool Pad-3 Min Level To Operate	1 
Cool Pad-4 Min Level To Operate	1 		
Cool Pad Flush			
Flush Cool Pad At	00:00 	Cool Pad Flush Duration (Minutes)	0 



## Cool Pad

- **Define:**
  - **Temperature Band:** Define the on/off delay relative to temperature.
  - **Humidity Band (%):** Define the on/off delay relative to humidity.
  - **Diff Between Cool Pads Stage:** Platinum Touch/One supports four cooling pad stages. The controller activates the first stage when the temperature reaches the Tunnel Temperature (Control > Temperature Curve) plus the Tunnel Differentiation (set in the Cool Pad screen). Each additional stage begins when the temperature reaches the Tunnel Temperature plus the Tunnel Differentiation plus this differentiation.

For example, if:

- Tunnel Temperature = 80°
- Tunnel Diff = 2
- Diff between Cool Pads Stage = 3

Stage 1 starts at 82°, Stage 2 at 85°, Stage 3 at 88°, and Stage 4 at 91°.

Example: Cool Pad ON temperature = 80°, Diff set to 2° F:

Cool Pad #	Assigned Sensor	Diff Between Cool Pads Stage	Actual ON temperature
1	Average	0.0	80°
2	Average	2.0	82°
3	Temp Sensor 2	0.0	80°
4	Temp Sensor 2	2.0	82°

- **Cool Pad Minimum Level:** In systems having more than one pump, this parameter enables keeping a cool pad inoperative until the associated tunnel curtain turns on. Define the minimum level for each cool pad.

*NOTE When the Difference Between Cool Pads Stage is enabled, the cool pads operate according to both conditions.*

## Cool Pad Flush

- **Flush Cool Pad At:** Enter the time to flush cool pads.
- **Cool Pad Flush Duration (minute):** Enter the process duration time.

### 3.9.2 COOL PAD, VERSION 7.22 AND ABOVE

As an option, Version 7.22 supports Cool Pad Ramping. Please note that Version 7.22 also supports the non-ramping option.

Ramping means that the user defines under what climatic conditions cool pads change their working/non-working periods. The user defines the cool pads minimum and maximum off times. As the temperature changes, the controller automatically adjusts the off time. For example, if the temperature increases, the controller reduces the off time. The cool pad(s) continues to operate until the temperature decreases to a user defined point.

Additional pads begin to operate based on:

- the Cooling Differential which is the temperature difference required to activate additional cooling pads.
- the ventilation level at each cooling pad begins to operate.

The user sets the following parameters to configure ramping:

- On/Off temperatures.
- Ramping range is the temperature range (above the Cool Pad ON temperature) in which ramping takes place. If the temperature rises above the defined range, ramping ceases.
- The user defines the On time, which remains constant for each day and the minimum/maximum Off times. The controller then automatically adjusts the Off time as the temperature changes.
- You can specify the time frame during the day when cooling can take place.
- You can define how the humidity affects the cool pads.

*NOTE Incorporating humidity levels in the operating parameters requires installing a humidity sensor. Invalid sensor readings disable these conditions.*

### 3.9.2.1 Cool Pad Main Screen

➔ Define relays as cool pads. Refer to Relay Layout, page 125.

To configure Cool Pad Ramping:

1. Go to Control > Control Mode and enable Cooling Ramping.



The screenshot shows the 'Control Mode' interface. At the top left, the title 'Control Mode' is displayed in blue. To the right of the title are three icons: a mail icon, a refresh icon, and a settings gear icon. Below the title is a list of settings, each with a label on the left and a control element on the right:

Setting	Value/Control
Growing Zone	Full House ▾
House Mode	NORMAL ▾
Temperature Curve	On <input checked="" type="radio"/>
Min Max Levels Control	By Days ▾
Heat Cycle	<input type="radio"/> No
Analog Heat Mode	Linear ▾
THI Mode	No ▾
Cooling Ramping	Yes ▾

2. Go to Control > Cool Pad.

Cool Pad					
Day	On Temp Diff	Off Temp Diff	On Time	MaxOff Time	MinOff Time
0	0.0	0.0	0	0	0
0	0.0	0.0	0	0	0
0	0.0	0.0	0	0	0
0	0.0	0.0	0	0	0
0	0.0	0.0	0	0	0

### 3. Define:

- **Day:** Defines the growth day at which the cooling function takes place. Only one line per day is valid. If more than one line defines the same day, the last line only defines the function.
- **On Temp Difference:** Set the difference from the tunnel temperature (defined in the Temperature Curve, page 18) at which cooling begins. Range: -36.0° to +36.0° F/-20° to +20° C. Default: 0
- **Off Temp Difference:** Set the difference from the tunnel temperature (defined in the Temperature Curve, page 18) at which cooling ceases. Range: -36.0° to -5.9° F/-20° to --3.3° C. Default: 0

*NOTE Each cooling pad operates according to its own temperature sensor (refer to Temperature Definition, page 139).*

- **On Time:** Define the operating time. Range: 0 – 999 seconds. Default: 0
- **Maximum Off Time:** Define the maximum amount of time that a cooling pad remains off before restarting. Range: 0 – 999. Default: 0. Set the time to 0 for continuous operation.
- **Minimum Off Time:** Define the minimum amount of time that a cool remains off before restarting. Range: 0 – 999. Default: 0

### 4. Define the Set Definitions.

### 3.9.2.2 Cool Pad Help | Set Definitions

Cool Pad - Settings			
Cool Pad			
Enable Cooling From Time	00:00	Enable Cooling To Time	00:00
Ramping Temperature Range	5.0	Humidity % To Stop Cooling	100
Humidity Band %	5	Diff. Between Cool Pads Stage	0.0
Cool Pad-1 Min Level To Operate	1	Cool Pad-2 Min Level To Operate	1
Cool Pad-3 Min Level To Operate	1	Cool Pad-4 Min Level To Operate	1

- Define:
  - **Enable Cooling From/To Time:** Define the hours between which cooling pads can operate. Range: 00:00 – 23:59. Default: 00:00 (always enabled)
  - **Ramping Temperature Range:** Define the maximum temperature at which ramping takes place. Ramping takes place between the On Temperature (+ 0.5°) and this point. For example if cooling begins at 75° and the ramping range is 10°, ramping continues until the temperature reaches 85.5°. Range: 0 – 36° F/0 – 20° C. Default: 36°/20°.
  - **Humidity % to Stop Cooling:** Above this level, cooling ceases. Range 0 – 100%. Default: 100%

*NOTE As cool pads operate, the humidity can rise to the level that causes cool pads to stop operating.*

- **Off Humidity Band:** Define the drop in humidity that must occur before cooling restarts (after cooling ceases because of high humidity). Range: 0 – 20%. Default: 5%
- **Diff Between Cool Pads Stage:** Define the temperature differential required for the next cool pad to begin operating. Range: 0 – 36° F/0 – 20° C
- **Cool Pad 1 – 6 Minimum Level to Operate:** Define the ventilation level for each cool pad. Range: 0 – 30. Default: 1

### 3.10 Foggers

This menu sets the Foggers operating conditions. Foggers differ from the Cool Pad:

- Foggers and Cool Pad have different temperature reference points. The Fogger Temperature Differentials are relative to the target temperature; the Cool Pad is relative to the tunnel entry temperature.
- Foggers operate even when the controller is not in tunnel mode.

Foggers						
Day	Start Time	End Time	Target Diff	To Humidity	On (Sec.)	Off (Sec.)
0	00:00	00:00	0.0	0	0	0
0	00:00	00:00	0.0	0	0	0
0	00:00	00:00	0.0	0	0	0
0	00:00	00:00	0.0	0	0	0

1. In *System > Relays*, define relays as Fogger.





2. In *Control > Foggers*, define:

- Day: Set the growth day.
- Start Time & End Time: Time of day you want foggers to start and stop.
  - It is possible to set multiple start and stop times for a single day.
- Target Diff: Set difference from the tunnel temperature to trigger foggers.
- To Humidity: Set maximum humidity allowed before stopping foggers.
- On Sec: Set the maximum on time for each cycle of fogger operation.
- Off Sec: Set the minimum off time for each cycle of fogger operation.



3. If required, click  and parameters as required.

### 3.10.1 FOGGERS HELP | SET DEFINITIONS

Foggers - Settings			
Foggers			
Temperature Band	1.1 	Humidity Band (%)	2 
Min Level To Enable Operation	1 	Max Level To Enable Operation	30 
Enable Rotation	<input type="radio"/> No	Diff. Between Foggers Stage	0.0 

- Define:
  - **Temperature Band:** Define the on/off delay relative to temperature.
  - **Humidity Band (%):** Define the on/off delay relative to humidity.
  - **Minimum Level to Enable Operation:** Select the minimum ventilation level to operate the foggers.
  - **Maximum Level to Enable Operation:** Set the maximum ventilation level for fogger operation.
  - **Enable Rotation:** Enable this function to use a different fogger relay for each cycle. This function enables dispersing the droplets at a higher pressure, to wet the animal.

*NOTE Munters recommends keeping this function set at the default setting (No).*

- **Difference between Foggers Stage:** Platinum Touch/One supports four fogging stages. The controller activates the first stage when the temperature reaches the Target Temperature (Control > Temperature Curve) plus the

foggers' differential. Each additional stage begins when the temperature reaches the Target Temperature plus the fogger differentiation.

### 3.11 Water & Feed Control

This menu sets the operating conditions for water and feed devices.

- Control via Time
- Control via Quantity
- Control by Feed Counter
- Water and Feed Help | Set Definitions

#### 3.11.1 CONTROL VIA TIME

1. In *System > Relay Layout*, define relays as Water, Feed, or Auger.
2. Go to *Control > Water & Feed > Set* and define Feed by Quantity as No.

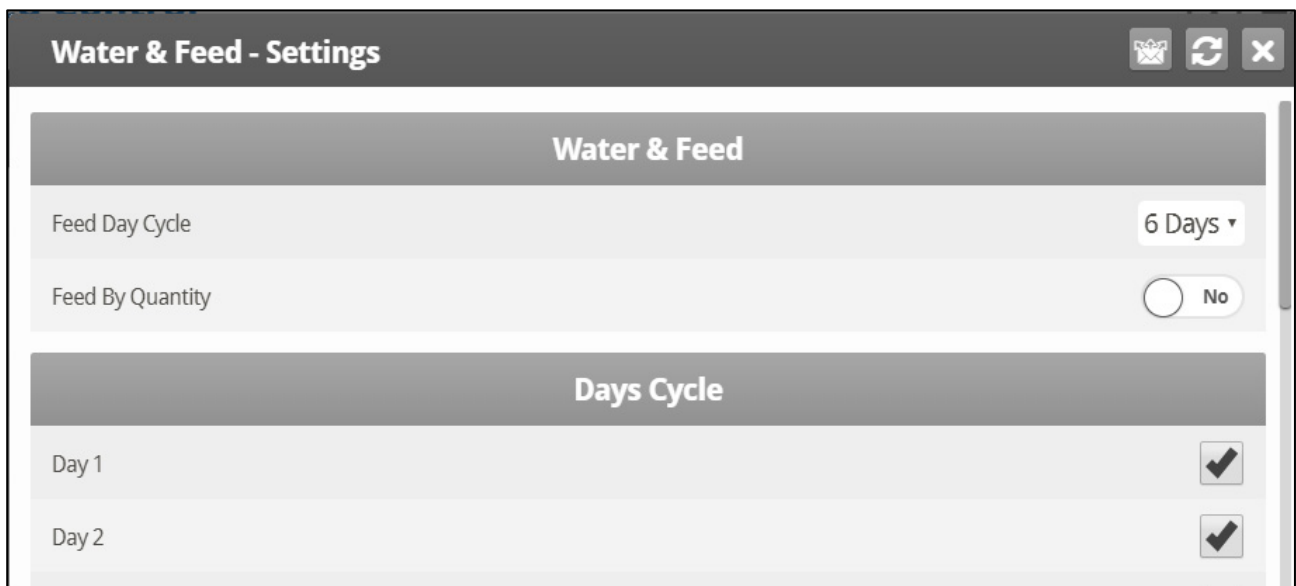

3. Go to *Control > Water & Feed*.

Water & Feed Control				
Day	Time	Water	Feeder	Auger
		1	1	1
1	03:00	<input type="radio"/> off	<input checked="" type="radio"/> On	<input checked="" type="radio"/> On
1	05:00	<input type="radio"/> off	<input type="radio"/> Off	<input type="radio"/> off
1	05:30	<input type="radio"/> off	<input checked="" type="radio"/> On	<input checked="" type="radio"/> On
1	06:00	<input type="radio"/> off	<input type="radio"/> Off	<input type="radio"/> off
1	07:00	<input type="radio"/> off	<input checked="" type="radio"/> On	<input checked="" type="radio"/> On
1	08:00	<input type="radio"/> off	<input type="radio"/> Off	<input type="radio"/> off
1	09:00	<input type="radio"/> off	<input checked="" type="radio"/> On	<input checked="" type="radio"/> On
1	10:00	<input type="radio"/> off	<input type="radio"/> Off	<input type="radio"/> off
1	11:00	<input type="radio"/> off	<input checked="" type="radio"/> On	<input checked="" type="radio"/> On
1	12:00	<input type="radio"/> off	<input type="radio"/> Off	<input type="radio"/> off
1	13:00	<input type="radio"/> off	<input checked="" type="radio"/> On	<input checked="" type="radio"/> On

4. Define:

- **Day:** Set growth day. You can define days as negative days.
- **Time:** Set event times for water, feeder, or auger.

*NOTE In Layers Mode, the time format is hh:mm:ss (in Control by Time only).*

- **Water/Feeder/Auger:** Turn on the required devices that will run at the set times.

5. Set the [Water Overflow Alarms](#) and [Water Shortage Alarms](#).

*NOTE You can implement mealtime, clean up meals and other options similarly as shown earlier in the light programs.*

### 3.11.2 CONTROL VIA QUANTITY

1. In *System > Relay Layout*, define relays as Water, Feed, or Auger.
2. In *System > Scale Layout*, map each silo to a channel.
3. Go to *Control > Water & Feed > Set*.
4. Define Feed by Quantity as Yes.

**Water & Feed - Settings**

**Water & Feed**

Feed Day Cycle 6 Days ▾

Feed By Quantity  Yes

**Days Cycle**

Day 1

Day 2

5. Go to *Control > Water & Feed*.

Water & Feed Control												
Day	From Time	To Time	Water			Feeder			Feed			
			1	2	3	1	2	3	1	2	3	4
1	06:00	08:00	<input checked="" type="radio"/> On	<input type="radio"/> Off	<input checked="" type="radio"/> On	<input checked="" type="radio"/> On	<input type="radio"/> off	<input type="radio"/> Off	100	100	100	100
1	11:00	13:00	<input type="radio"/> off	<input type="radio"/> Off	<input checked="" type="radio"/> On	<input checked="" type="radio"/> On	<input type="radio"/> off	<input type="radio"/> Off	75	75	75	75
0	00:00	00:00	<input type="radio"/> off	<input type="radio"/> Off	<input type="radio"/> off	<input type="radio"/> off	<input type="radio"/> off	<input type="radio"/> Off	0	0	0	0
0	00:00	00:00	<input type="radio"/> off	<input type="radio"/> Off	<input type="radio"/> off	<input type="radio"/> off	<input type="radio"/> off	<input type="radio"/> Off	0	0	0	0
0	00:00	00:00	<input type="radio"/> off	<input type="radio"/> Off	<input type="radio"/> off	<input type="radio"/> off	<input type="radio"/> off	<input type="radio"/> Off	0	0	0	0
0	00:00	00:00	<input type="radio"/> off	<input type="radio"/> Off	<input type="radio"/> off	<input type="radio"/> off	<input type="radio"/> off	<input type="radio"/> Off	0	0	0	0
0	00:00	00:00	<input type="radio"/> off	<input type="radio"/> Off	<input type="radio"/> off	<input type="radio"/> off	<input type="radio"/> off	<input type="radio"/> Off	0	0	0	0
0	00:00	00:00	<input type="radio"/> off	<input type="radio"/> Off	<input type="radio"/> off	<input type="radio"/> off	<input type="radio"/> off	<input type="radio"/> Off	0	0	0	0
0	00:00	00:00	<input type="radio"/> off	<input type="radio"/> Off	<input type="radio"/> off	<input type="radio"/> off	<input type="radio"/> off	<input type="radio"/> Off	0	0	0	0
0	00:00	00:00	<input type="radio"/> off	<input type="radio"/> Off	<input type="radio"/> off	<input type="radio"/> off	<input type="radio"/> off	<input type="radio"/> Off	0	0	0	0
0	00:00	00:00	<input type="radio"/> off	<input type="radio"/> Off	<input type="radio"/> off	<input type="radio"/> off	<input type="radio"/> off	<input type="radio"/> Off	0	0	0	0

6. Define:

- **Day:** Set growth day. You can define days as negative days. Growth days stay at the defined parameters until the next defined day.
- **From Time/To Time:** Set the time period during which water and feeding lines can operate.
- **Water:** Select a check mark to mark water lines to turn on, dot the ones to turn off.
- **Feeder:** Check mark feed lines to turn on, dot the ones to turn off.
- **Feed:** Enter the quantity of feed provided from the silos during the From/To time.
  - You can provide feed from multiple silos, enabling specific feed mixes.
  - Distribution continues until the **To Time** or until the defined quantity is reached, whichever comes first.
  - If a relay is not defined as an auger the Feed numbers still appear. However any quantity entered is meaningless.

Water runs continually between the From/To times. Only feed is distributed in cycles.

*NOTE This function only works when relays are defined as augers and each silo is mapped to an auger. Defining a digital sensor as a feed count does not enable Control by Quantity.*

*NOTE If both Control via Quantity and a digital feed counter are enabled, Control via Quantity takes priority.*

### 3.11.3 CONTROL BY FEED COUNTER

Control by Feed enables measuring the amount of feed distributed via the digital sensors. These sensors record each time the feeding equipment delivers a (fixed) quantity of feed. By measuring the number of feed pulses, the controller can record the quantity (weight) of feed delivered.

- When using this method there is no need to define silos.
- The user must know how much feed is delivered by the feed equipment.



1. In *System > Relay Layout* (page 125), define 1 – 4 relays as an auger.
2. In *System > Digital Sensors*, define the required number of digital sensors as **Feed Count**.
3. In *Control > Water & Feed > Help Settings*, select **Feed Counter**.

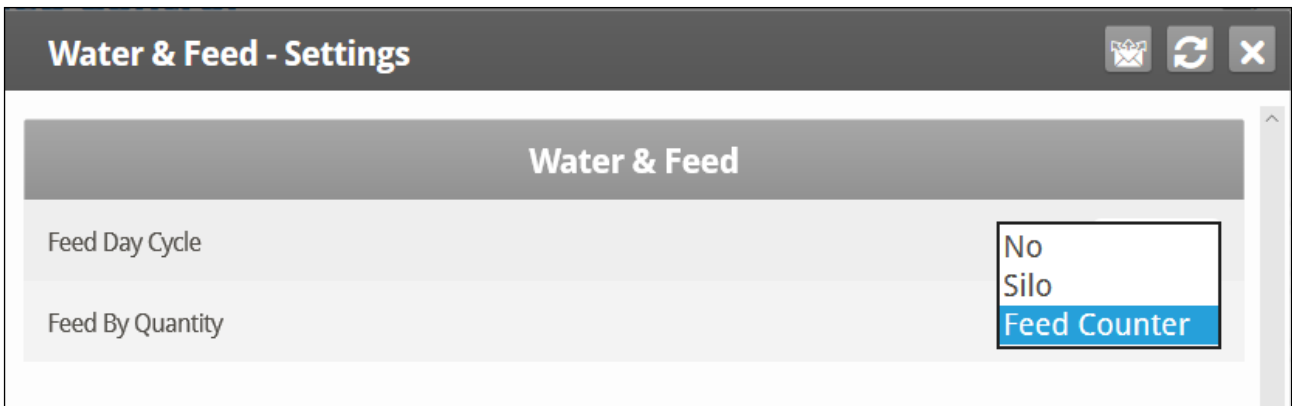

4. In *Control > Water and Feed*, define the parameters as required.
5. In *Service > Feed Calibration*:
  - Define the Method as **Pulse**
  - In Factor, enter the weight of each delivery
6. Set the [Water Overflow Alarms](#) and [Water Shortage Alarms](#).

Water & Feed Control												
Day	From Time	To Time	Water			Feeder			Feed			
			1	2	3	1	2	3	1	2	3	4
1	06:00	08:00	On <input checked="" type="radio"/>	Off <input type="radio"/>	On <input checked="" type="radio"/>	On <input checked="" type="radio"/>	Off <input type="radio"/>	Off <input type="radio"/>	100	100	100	100
1	11:00	13:00	Off <input type="radio"/>	Off <input type="radio"/>	On <input checked="" type="radio"/>	On <input checked="" type="radio"/>	Off <input type="radio"/>	Off <input type="radio"/>	75	75	75	75
0	00:00	00:00	Off <input type="radio"/>	Off <input type="radio"/>	Off <input type="radio"/>	Off <input type="radio"/>	Off <input type="radio"/>	Off <input type="radio"/>	0	0	0	0
0	00:00	00:00	Off <input type="radio"/>	Off <input type="radio"/>	Off <input type="radio"/>	Off <input type="radio"/>	Off <input type="radio"/>	Off <input type="radio"/>	0	0	0	0
0	00:00	00:00	Off <input type="radio"/>	Off <input type="radio"/>	Off <input type="radio"/>	Off <input type="radio"/>	Off <input type="radio"/>	Off <input type="radio"/>	0	0	0	0
0	00:00	00:00	Off <input type="radio"/>	Off <input type="radio"/>	Off <input type="radio"/>	Off <input type="radio"/>	Off <input type="radio"/>	Off <input type="radio"/>	0	0	0	0
0	00:00	00:00	Off <input type="radio"/>	Off <input type="radio"/>	Off <input type="radio"/>	Off <input type="radio"/>	Off <input type="radio"/>	Off <input type="radio"/>	0	0	0	0
0	00:00	00:00	Off <input type="radio"/>	Off <input type="radio"/>	Off <input type="radio"/>	Off <input type="radio"/>	Off <input type="radio"/>	Off <input type="radio"/>	0	0	0	0
0	00:00	00:00	Off <input type="radio"/>	Off <input type="radio"/>	Off <input type="radio"/>	Off <input type="radio"/>	Off <input type="radio"/>	Off <input type="radio"/>	0	0	0	0
0	00:00	00:00	Off <input type="radio"/>	Off <input type="radio"/>	Off <input type="radio"/>	Off <input type="radio"/>	Off <input type="radio"/>	Off <input type="radio"/>	0	0	0	0

- **Day:** Set growth day. You can define days as negative days. Enter the number and then press the +/-key. Growth days stay at the defined parameters until the next defined day.
- **From Time/To Time:** Set the time period during which water, feeder, and feed lines can operate.
- **Water:** Select a check mark to mark water lines to turn on, dot the ones to turn off.
- **Feeder:** Check mark feed lines to turn on, dot the ones to turn off.
- **Feed:** Enter the quantity of feed provided from the silos during the From/To time.

- You can provide feed from multiple silos, enabling specific feed mixes. Each auger delivers feed from the silo having the same number; meaning Auger 1 receives feed from Silo 1 and so on.
- Distribution continues until the To Time or until the defined quantity is reached, whichever comes first.
- If a relay is not defined as an auger the Feed numbers still appear. However any quantity entered is meaningless.

This function only works when relays are defined as augers.

### 3.11.4 WATER AND FEED HELP | SET DEFINITIONS

These parameters define the feed and water delivery schedule through the week.

**Water & Feed - Settings**

**Water & Feed**

Feed Day Cycle: 3 Days ▾

Feed By Quantity: Yes

**Days Cycle**

Day 1:

Day 2:

Day 3:

**Water On No Feed Days**

Start: 00:00

Stop: 00:00

**NOTE** The Water and Feed parameters work in conjunction with the Lighting parameters.

- **Feed Day Cycle:**
  - **Daily:** Same schedule for every day of the week.
  - **2 – 6 Days:** Select a cycle that lasts the number of days chosen and then repeats itself. For example, 2 Days means that the cycle lasts two days and then repeats itself.
  - **Week:** Select which days in the week that feed and water are delivered.
- **Quantity:** Enable this feature to enable Control by Quantity.

**NOTE** If you choose Daily, the Scale function is always enabled. If you choose 2- 6 Days or Week, the Scale function is disabled on non-feeding days.

**CAUTION** If you want to provide feed every day, select Daily. Selecting Week and marking each day causes problems with this function.

If you select the 2 – 6 Day schedule or the Week schedule, configure:

- **Week/Days Cycle (2 – 6 Days):** Select which days in the cycle that feed and water is delivered.
- **Water on No Feed Days:** Select up to two time periods when water is delivered on non-feed days.

*NOTE On feed days, water is delivered when feed is delivered.*

### 3.12 Light

This menu sets the lights operating conditions. The controller has a capacity for up to four channels of On/Off Lights and up to 10 channels of Dimmer Lights. In addition, this menu enables using a light sensor.

1. Do one or both:

- In *System > Analog Output*, define up to 10 outputs as light dimmers.
- In *System > Relays* define up to 10 outputs as light.

2. In *Control > Water & Feed > Help*, define Feed by Cycle.

3. In *Control > Light*, select **Light Feed**. The Light parameters screen appears. These parameters configure the Light functions on feed days.

- If the Feed by Cycle is set to 2- 6 Days, select Light No Feed. The Light parameters screen appears. These parameters configure the Light functions on non-feed days.

Day	Time	Light		Light Dimmer
		1	2	1
1	03:00	On <input checked="" type="radio"/>	<input type="radio"/> Off	60
1	06:00	On <input checked="" type="radio"/>	On <input checked="" type="radio"/>	50
1	08:00	On <input checked="" type="radio"/>	<input type="radio"/> Off	60
1	17:00	On <input checked="" type="radio"/>	<input type="radio"/> Off	100
1	23:00	On <input checked="" type="radio"/>	<input type="radio"/> Off	0
0	00:00	<input type="radio"/> Off	<input type="radio"/> Off	0
0	00:00	<input type="radio"/> Off	<input type="radio"/> Off	0
0	00:00	<input type="radio"/> Off	<input type="radio"/> Off	0
0	00:00	<input type="radio"/> Off	<input type="radio"/> Off	0

4. Define:

- **Day:** Set Growth Day

In the example, the brood lights (channel 1) and bright center lights (channel 2) turn on from day 1, while the grow end lights (channel 3) are off. The example shows two channels of light dimmer, Channel 1 at 100% and Channel 2 at 0% (for baby chicks in the brood zone).

- **Time:** Set event times for the lights.

- On day 12, the center lights turn off, and the dimmer lights go to 45%. There are two periods of darkness: from 01:00 to 03:00 in the morning, and 09:00 PM to midnight. This program repeats until day 25.
- From day 25 the on/off lights stay off, and the dimmer lights provide dim light during the on periods and go out fully for two periods of darkness. The dark periods total 6 hours, being from midnight to 03:00 AM and from 08:00 PM (20:00) to 11:00 PM (23:00).
- **On/Off:** Select the required light(s) to turn on.
- **Light Dimmer (%):** Set intensity in percentage for light dimmer(s). Dimmer lights start to brighten if the intensity increases, and complete dimming if the intensity decreases at the set time. That is, they start dimming the 'sunset time' in advance of the set time (see **Help | Set** below).

5. If required, click  and set the parameters.

### 3.12.1 LIGHT HELP | SET DEFINITIONS

**Light - Settings**
⚙️ ↻ ✕

Light			
Sunrise Time (Min.)	10	Sunset Time (Min.)	10
Allow Spiking From Day	1	Spike Cycle (Min.)	0
Spike Duration (Min.)	0	Spike Increase Amount (%)	0
Signal Light Is:	None	Signal Before Feed (Sec.)	0
Signal During Feed (Sec.)	0	Light Sensor Active	<input type="checkbox"/> No

- **Define:**
  - **Sunrise Time (minutes):** The amount of time required for the light intensity to rise from 0% to the designated level.
  - **Sunset Time (minutes):** The amount of time required for the light intensity to decline from the designated level to 0%.
  - **Allow Spiking from Day:** The day spiking begins.
  - **Spike Cycle (minutes):** The time length that the spike is at its maximum level. Reaching the maximum level and returning to the preset level both take one minute. For example if the spike duration is 10 minutes, the spike cycle is 8 minutes.
  - **Spike Duration (minutes):** The total amount of time of the spike cycle, including the rise and fall times.

- **Spike Increase Amount (%):** Set the increase in intensity for the spike in relation to the current light intensity.
- **Signal Light Is:** Only one light operates during feeding times. Select which light is lit or choose “None”.

*NOTE After the feeding period ends, all lights selected in the Light Parameters screen relight.*

- **Signal Before Feed (seconds):** Amount of time before the feeding starts, that all other lights go off.
- **Signal During Feed (seconds):** Amount of time that the selected light remains on after feeding ends.

*NOTE The above two parameters are disabled on no feed days.*

- **Light Sensor Active:** The light sensor turns off all lights when sufficient outside lights exist. If a light sensor is installed, enable this option to turn off the light during feeding time when there is sufficient outside light. Refer to [Light Sensor Calibration](#) for details.

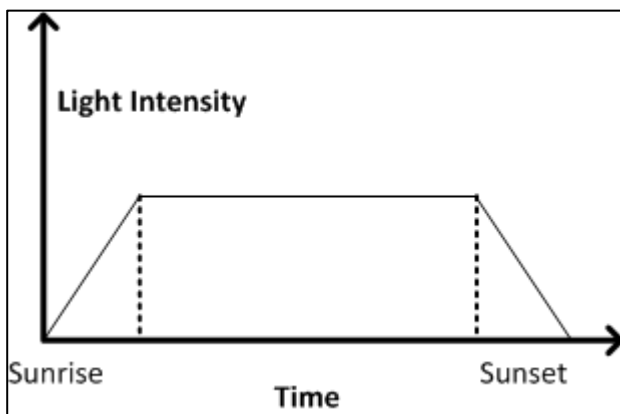

Figure 9: Lighting without Spiking

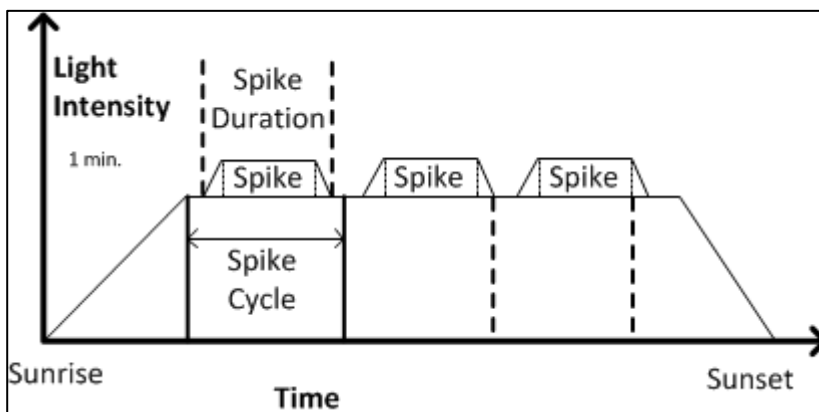

Figure 10: Lighting with Spiking

*NOTE The initial reference time for the Spike Cycle is the end of Sunrise. The spike begins Spike Duration minutes before the end of the Spike Cycle and has one minute up and down ramps in intensity. If Sunrise Duration is set to zero, no spiking occurs.*

### 3.12.2 LIGHT MEASUREMENT CONTROL

Version 7.20 supports employing a LUX light sensor to control the light intensity. In this function, the Target LUX is the defined light intensity target. The controller measures the light intensity in LUX values and adjusts the output accordingly.

- On/OFF Light Function does not operate when using Light Dimming by LUX.
- Sunrise/Sunset functions do not operate when using Light Dimming by LUX.

To configure light measurement:

1. In System > Sensors > Analog, define a sensor as Light 0 – 40 LUX.

Output No.	Function	Sensor No.
Card 1 Main Slot 2		
1	Temperature	1
2	Temperature	2
3	Temperature	3
4	Temperature	4
5	Temperature	5
6	Light Sensor Lux	1

2. Go to Control > Light. Target LUX only appears if a sensor was defined.

Day	Time	Target Lux	Light		Light Dimmer
			1	2	2
1	00:00	0	On <input type="radio"/>	On <input type="radio"/>	0
1	01:00	0	On <input type="radio"/>	On <input type="radio"/>	0
1	02:00	0	On <input type="radio"/>	On <input type="radio"/>	0
1	03:00	0	On <input type="radio"/>	On <input type="radio"/>	0
1	04:00	0	On <input type="radio"/>	On <input type="radio"/>	0

3. Define the target.

4. If required, click  and set the parameters.

5. Define:

- LUX Band (LUX): No change in light output takes place while the measured amount of light is within this band (percentage). Default 2. Range 2 – 10.
- Increase Interval Time (sec): The interval time for the light intensity to increase (by 1%) from the previous change. Default. Range 0 – 120.

- Decrease Interval Time (sec): The interval time for the light intensity to decrease (by 1%) from the previous change. Default. Range 0 – 120.
6. Set the Low Light Intensity Alarm, page 89 (optional).

### 3.13 Extra Systems

This menu sets the parameters of other devices that are not listed in the controller.

Extra Systems								
System	Start Time	End Time	Temperature		Humidity		On (Sec.)	Off (Sec.)
			From	To	From	To		
1	00:00	00:00	0.0	0.5	0	0	0	0
2	00:00	00:00	0.0	0.5	0	0	0	0
3	00:00	00:00	0.0	0.5	0	0	0	0
4	00:00	00:00	0.0	0.5	0	0	0	0

1. In *System > Relay Layout*, define relays as Extra System.

2. Go to *Control > Extra System*.

3. Define:

- **Start Time:** Time at which this Extra System starts.
- **End Time:** Time at which this Extra System stops.
- **Temperature From:** Temperature above which Extra System operates.
- **Temperature To:** Temperature below which Extra System operates.
- **Humidity From:** Humidity above which Extra System operates
- **Humidity To:** Humidity below which Extra System operates.
- **On (Sec):** On time for the Extra System. If set to 0, the extra system does not operate.
- **Off (Sec):** Off time for Extra System after completion of on time. If you have values in both **ON** and **Off**, the extra system cycles. If you have zero OFF time, and any ON time, the system simply stays on as long as the other parameters are satisfied.

*NOTE All parameters must be satisfied for an Extra System to operate. For example if the temperature is below the From Temperature or the Humidity below the From Humidity, the system is OFF. You can assign specific temperature sensors to an Extra System in [Install | Temp Definition](#). The Extra System uses the Inside Humidity, not the Outside Humidity. If there is no humidity sensor, the Extra Systems ignore the humidity parameters.*

## 3.14 Control Mode

Select house-operating modes, turn temperature curves on or off and select which type of min/max level method to use.

- Control Mode Main Screen
- Catching Mode

### 3.14.1 CONTROL MODE MAIN SCREEN

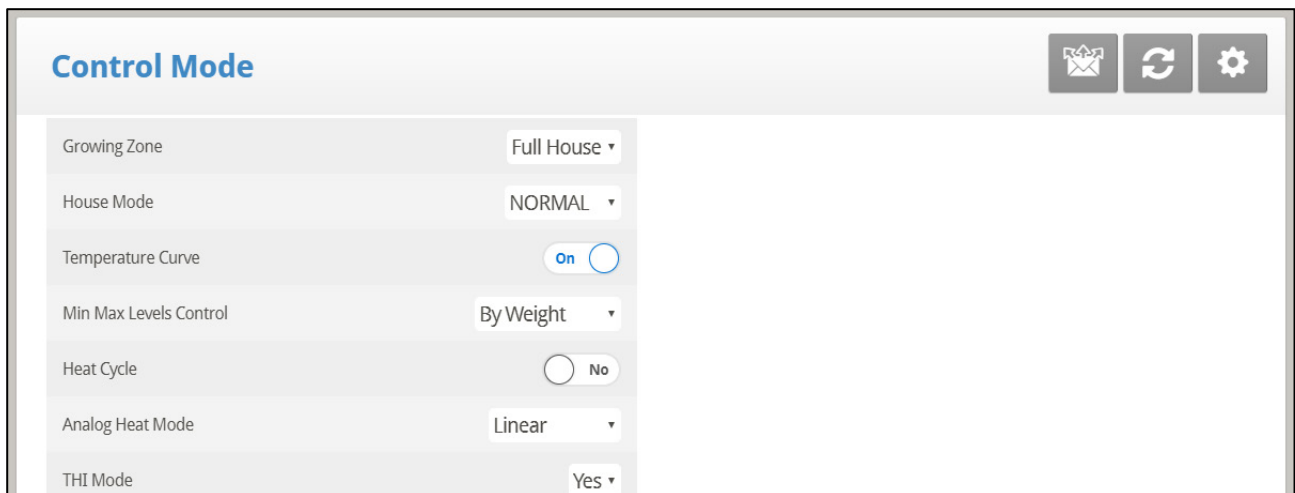

The screenshot shows the 'Control Mode' interface. At the top left is the title 'Control Mode'. At the top right are three icons: a house with a crown, a refresh symbol, and a gear. Below the title is a list of settings:

Growing Zone	Full House ▾
House Mode	NORMAL ▾
Temperature Curve	On <input checked="" type="radio"/>
Min Max Levels Control	By Weight ▾
Heat Cycle	<input type="radio"/> No
Analog Heat Mode	Linear ▾
THI Mode	Yes ▾

- **Define:**
  - **Growing Zone:** Select whether the house is in one of the brood set-ups or in full house.
  - **House Mode:** Select:
    - Normal
    - Empty: All alarms and functions are disabled.
    - Catching: Refer to Catching Mode.
  - **Temperature Curve:** If you select OFF, temperature settings become fixed values until midnight on the next setting in [Temperature Curve](#).
  - **Minimum Maximum Level Control:** Set ventilation control method (By Days, By Days Curve, By Time, By Soft Min, and Weight). Refer to [Minimum/Maximum Level](#) for more details).
  - **Heat Cycle:** Enable cycle heaters. Refer to Cycle Heaters Help | Set Definitions, page 19.
  - **Analog Heat Mode:** Define the variable heating mode (Linear, Proportional, Linear Valve). Refer to Variable Heater Help | Set Definitions, page 22.
  - **THI Mode:** Enables Temperature Humidity Index. Refer to Temperature Humidity Index, page 25.



### 3.14.2 CATCHING MODE

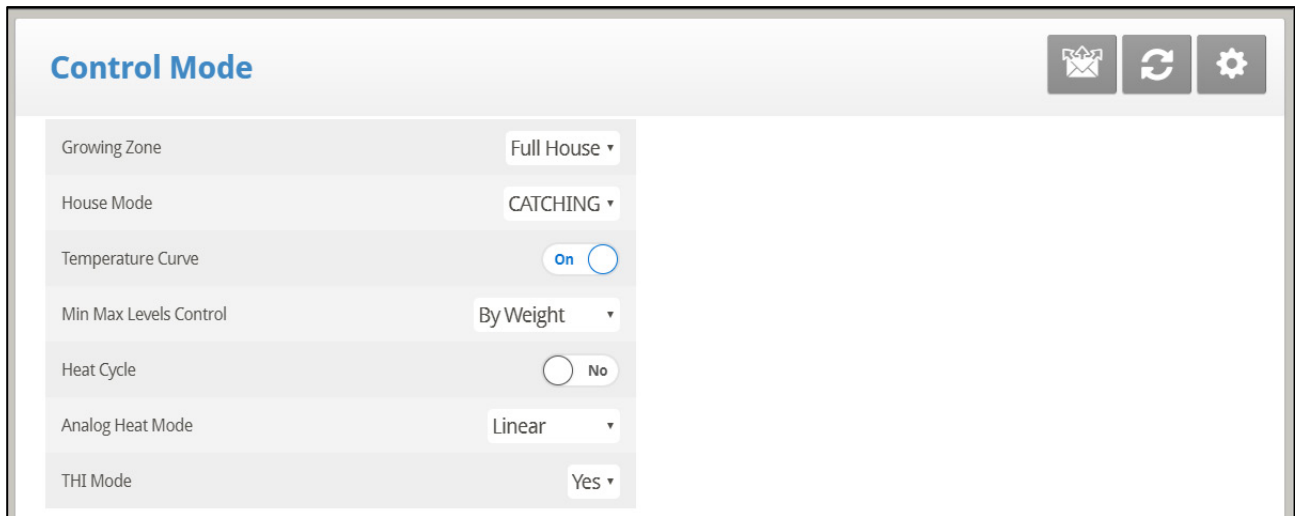

The screenshot shows a 'Control Mode' interface with the following settings:

Parameter	Value
Growing Zone	Full House ▾
House Mode	CATCHING ▾
Temperature Curve	On <input checked="" type="radio"/>
Min Max Levels Control	By Weight ▾
Heat Cycle	No <input type="radio"/>
Analog Heat Mode	Linear ▾
THI Mode	Yes ▾

Catching Mode is used when birds are being removed from the chicken house. In this mode:

- You can limit light intensity and ventilation
- The following functions are disabled.
  - Humidity/CO2/Ammonia treatment
  - Heating
  - Foggers
  - Water and feed
  - WOD
  - Nipple flushing
  - Feeders and drinkers' control
- High/low temperature and high static pressure alarms are active. All other alarms are disabled.

To configure Catching Mode.

1. In Control > Control Mode, define House Mode as Catching.

2. If required, click  and set the parameters:

- Light Intensity: Default 0%, range 0-100%
- Temp & Pressure Alarms Enable: Define as Yes or No.
- Level of Ventilation: 0 means ventilation works automatically. 1 – 30 sets the ventilation mode.

### 3.15 System Parameters

System Parameters consolidates all of the **HELP | SET** menus into one scroll screen.

The screenshot shows the 'System Parameters' interface. It has a title bar with a refresh icon. Below the title bar are three main sections: 'Temperature Curve', 'Cycle Heater', and 'Radiant Heaters'. Each section contains a list of parameters with their current values and edit icons.

Temperature Curve			
Temperature Curve Offset	0.0	Set Temperature Change Reminder (Diff.)	1.7
Target Temperature Band	0.6	Heater Temperature Band	0.6
Cool Down Factor (%)	15	Cool Down Fast Response (Deg.)	1.7
Min Vent Below Heat Temperature By:	<input type="radio"/> None <input type="radio"/> Zone <input checked="" type="radio"/> Average	Non Brood Area Diff. From Heat	-55.0

Cycle Heater			
Low Heat Differential	0.6	High Heat Differential	4.4
Min On Time	30		

**Radiant Heaters**

### 3.16 Ammonia Treatment

Ammonia treatment forces an increase in ventilation level when the ammonia level is too high. To prevent fans changing their ventilation too often, treatment begins after a user-defined delay. The user also defines the treatment duration.

After the duration, the ventilation level may come back down automatically. If during treatment, the ammonia level drops below the **Stop Value** parameter, the ventilation level automatically returns to that level used before ammonia treatment began.

The screenshot shows the 'Ammonia Treatment' interface with a table of parameters. The table has five columns: Day, Start Value, Stop Value, Delay (sec), and Duration (sec). The row for Day 10 is highlighted in blue.

Day	Start Value	Stop Value	Delay (sec)	Duration (sec)
1	25	10	90	120
7	25	10	90	150
10	25	10	90	180
0	2	0	0	0
0	2	0	0	0

➔ This function requires an ammonia sensor.

1. In *System > Analog Sensors* (refer to Analog Sensors), designate one sensor as an ammonia sensor.
2. If required, go to *Service > Ammonia* and calibrate the sensors (refer to Ammonia Calibration).
3. In *Control > Ammonia Treatment* set the parameters.
  - **Day:** Growth day. You can set multiple programs for same day (maximum number of programs: 20)

- **Start Value:** Ammonia value at which to begin treatment. Range: 0 to 100. Default: 2

*NOTE Ammonia levels should not be higher than 30 ppm.*

- **Stop Value:** Ammonia value at which to end treatment. Range: 0 to 100. Default: 2
- **Delay (Sec):** When the ammonia level reaches the start value, the controller delays treatment for this amount of time. Default: 0
- **Duration (Sec):** Number of seconds the controller maintains the increased level of ventilation. Default: 0

4. Set the Ammonia Alarm (page 66).

### 3.16.1 AMMONIA TREATMENT HELP | SET DEFINITIONS

- **Ammonia Treatment below Heat:** Select: Select YES or NO to enable Ammonia Treatment when heaters are operating (set in Temperature Curve).
- **Ammonia Treatment By:** This parameter designates the method used when ammonia treatment begins. Normally, this parameter is relevant only when minimum ventilation is running. When a treatment is required, select the method to be employed:
  - **Level:** Increases the ventilation level when a treatment is required.

*NOTE When employing Ventilation by Weight, the controller increases the cycle time or the level, depending on the particular settings.*

- **Exhaust:** Designate a specific exhaust fan (press a number key to select the fan).
- **Tunnel:** Designate a specific tunnel fan (press a number key to select the fan).
- **None:** Disables the treatment.

### 3.17 Feed Scale Program

*NOTE Broiler Mode supports this function.*

Feed Scale enables mixing different types of feeds from (up to) four different feed bins. The user fills each bin with the required feed type and sets the mixture ratios and quantities in Platinum. The augers then distribute the feed as defined.

This screen defines:

- the total quantity of feed to be delivered to the birds
  - the auger feed mixture.
1. In *System > Relay Layout* (page 125), define relays as augers as required.
  2. In *Management > Bird Inventory* (page 83), enter the number of birds.

3. In *System > Scale Layout*, map the feed scales.

4. Go to *Control > Feed Scale Program*.

Feed Scale Program						
Day	Feed Per Bird	Silo (%)				Total Feed
		1	2	3	4	
1	0.200	70	10	10	10	4,000
5	0.300	58	22	10	10	6,000
12	0.400	50	0	50	0	8,000
0	0.000	0	0	0	0	0
0	0.000	0	0	0	0	0
0	0.000	0	0	0	0	0
0	0.000	0	0	0	0	0
0	0.000	0	0	0	0	0
0	0.000	0	0	0	0	0
0	0.000	0	0	0	0	0
0	0.000	0	0	0	0	0

**5. Define:**

- **Day:** Define the days at which the feed per bird changes. Platinum Touch/One calculates a feed curve based on these days. You can define the days as negative days.
- **Feed per Bird:** Define the amount of feed per bird/pigs (kilograms) to be distributed. Platinum calculates the total amount of feed to be distributed based on this parameter and the Bird Inventory parameters.
- **Silo (%):** If there is more than one silo supplying feed, enter the percentage of the feed package that each silo supplies. Note that by default, Silo 1 supplies 100% of the feed. Any number entered in Silo 2, 3, or 4 is subtracted from Silo 1.
- **Total Feed:** Displays the amount of feed required for that day. This amount is calculated by multiplying the feed per bird by the number of birds in the bird inventory (taking into account any birds culled, died, or moved).
- **Today:** These numbers display the actual amount of feed required for the current growth day. In the example shown above, the growth day is Day 2. Platinum Touch/One calculates the curve from Day 1 to Day 5 and adjusts the numbers accordingly.

### 3.17.1 FEED SCALE HELP | SET DEFINITIONS



Feed Scale Setting	
Time [hh:mm]	00:00
Max Portion Weight	25
Max Auger Time (Min)	10
Not Empty Time (Min)	60
Stop Diff. 1 Weight	2.0
Stop Diff. 2 Weight	2.0
Stop Diff. 3 Weight	2.0

- **Define:**
  - **Time:** What time the hopper begins distributing feed to the birds or animals.
  - **Maximum Portion Weight:** Enter the feed scale container size.
  - **Maximum Auger Time [minutes]:** This parameter sets an alarm for the auger running time. Enter the number of minutes that the auger can run, after which an alarm appears on the Main Screen.
  - **Not Empty Time [minutes]:** This parameter sets an alarm for the feed container. The container should distribute all of its feed to the feed lines. If feed remains in the container, it could mean that there is a problem (for example, the valve doesn't open). Set the amount of time that feed can remain in the container, after which an alarm appears on the Main Screen.
  - **Stop Differential 1/2/3/4 Weight:** After each silo stops supplying feed to its auger line, a certain amount of feed continues to flow. This differential compensates for this excess and ensures that only the required amount gets to the feeding container. Enter the approximate amount of feed that can be found in the augers. The number does not need to be exact. In the following feed runs, Platinum will correct the amount entered.
  - **Optimizer:** This parameter sets the unit's sensitivity to signal noise (caused by a variety of factors). The sensitivity plays a role as the controller stabilizes itself. Greater amounts of noise require faster optimization. To view an indication of the controller's stability, go to *Scale Menu > Test* and perform a test. If the number remains stable, slower optimization is indicated. There are three settings: Default, Slower, Faster.

*NOTE Munters recommends leaving this parameter at the default level.*

- **Valve Close Time [seconds]:** Set the delay in time, if any, that the valve emptying the feed scale closes.
- **Feed Tare [A/D count]:** This specification is used for certain tests performed by a certified technician.

*NOTE Munters recommends leaving this parameter unedited.*

- **Operating Mode:** See following section.

### 3.17.2 OPERATING MODE

Operating Mode (Version 7.22) enables:

- Stopping and resuming feeding
- Initiating a feeding at any given time.

The parameter has three modes:

- Auto: Feeding operates according to the programming (default).
- Bypass: Feeding continues even if there is a problem with valves or scales. Valves remain open and augers continue to operate until the bypass state ends. During Bypass containers are filled by time (X kilos or pounds/minute).
- Stop: All feeding and feeding equipment stops.

To use the Bypass Mode:

1. From the drop-down list, select Bypass.

2. Define:

- Feed Rate Update Mode:
  - Auto: The controller uses the existing parameters to determine the feed rate. Note that if the user enters numbers in the Feed Rate Parameters, the controller will override these parameters if there is a contradiction between them and the existing parameters.
  - Manual: The user enters the feed rate in the parameters below.
- Feed Rate 1 – 4: Enter the amount of feed (kilograms or pounds) to be distributed by each auger per minute.

*NOTE* If a [hopper sensor](#) is installed, feed flow stops if there is an overflow alarm.

### 3.17.3 FEED SCALE HOT SCREEN

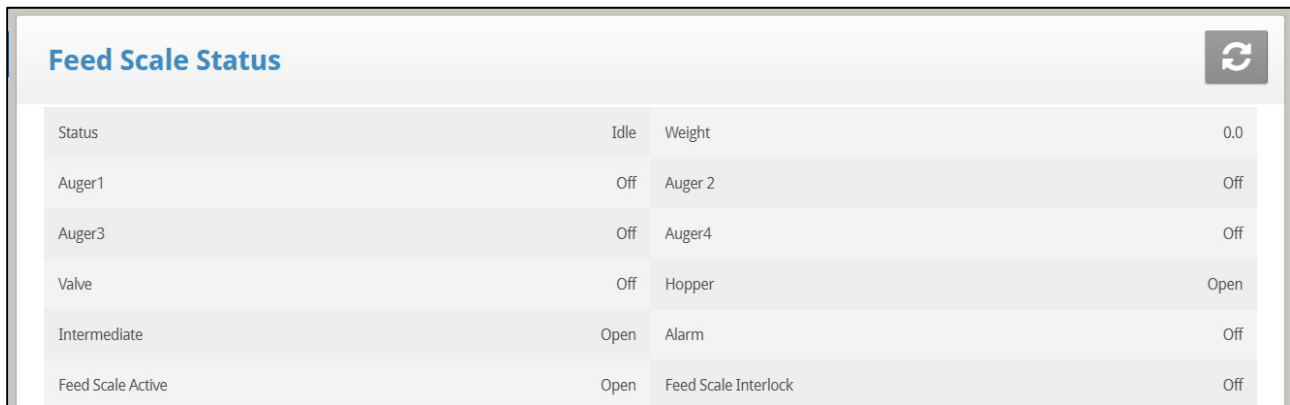

Feed Scale Status				
Status	Idle	Weight	0.0	
Auger1	Off	Auger 2	Off	
Auger3	Off	Auger4	Off	
Valve	Off	Hopper	Open	
Intermediate	Open	Alarm	Off	
Feed Scale Active	Open	Feed Scale Interlock	Off	

This screen shows the status of different areas of the feeding apparatus and illustrates the system components.

- **Status:** Shows the feed scale status: Idle, Emptying, or Filling.
- **Weight:** Shows the feed scale container weight
- **Auger 1/2/3/4:** Shows if the auger is running or off
- **Valve:** Shows if the valve emptying the feed scale is open
- **Feed S. Active:** This field shows which controller is managing the feed scale.
- **Feed S. Interlock:** The Feed Scale Interlock is a digital sensor which detects which damper is active.

- **Hopper:** The hopper is a digital sensor which detects if the feed has reached the maximum level in the feed bin. Define this sensor in *System > Digital Sensor*. This screen shows the sensor's current status. If the feed reaches the maximum amount, an alarm is triggered.
- **Intermediate:** The intermediate sensor is a digital sensor which detects if the feed has reached the maximum level in the feed bin. Define this sensor in *System > Digital Sensor*. This screen shows the sensor's current status.
- **Alarm:** This parameter shows if there are active alarms. View the alarms on the Main Screen.

### 3.17.4 FEED SCALE FUNCTIONALITY IN TWO HOUSES

Platinum Touch/One enables sharing feed scale functionality between two houses. Two load cells are connected to a single feed scale. Each Platinum Touch/One Controller is connected to one load cell.

When the system is running, one controller operates each set of augers, feed scale valve, hoppers, and so on. A mechanical damper switches the feed supply from the scale to the corresponding hopper. Only one feed process operates at a time; when one process is running the second is in standby.

- Each hopper auger is managed by a separate feed sensor, installed in the last dish in the last feed line in each house.
- Both Platinum Touch/One units are connected to a single feed scale container.
- Contactors connected to the silo augers determine which house is active.
- Each Platinum Touch/One controller is connected to a separate hopper sensor, which indicates when the hopper is filled.
- Important: Each Platinum Touch/One Controller transmits the Feed Scale State to the second controller, via the Feed Scale Active Relay. This relay prevents a controller from assuming control of the Feed Scale when the latter is active. Controller 1 will release control if:
  - The hopper sensor shows the hopper to be filled
  - The feed cycle is complete.
  - In addition, if an Auger Overtime alarm is generated, control is transferred to the other Platinum.
- Hot key (see Feed Scale Hot Screen)

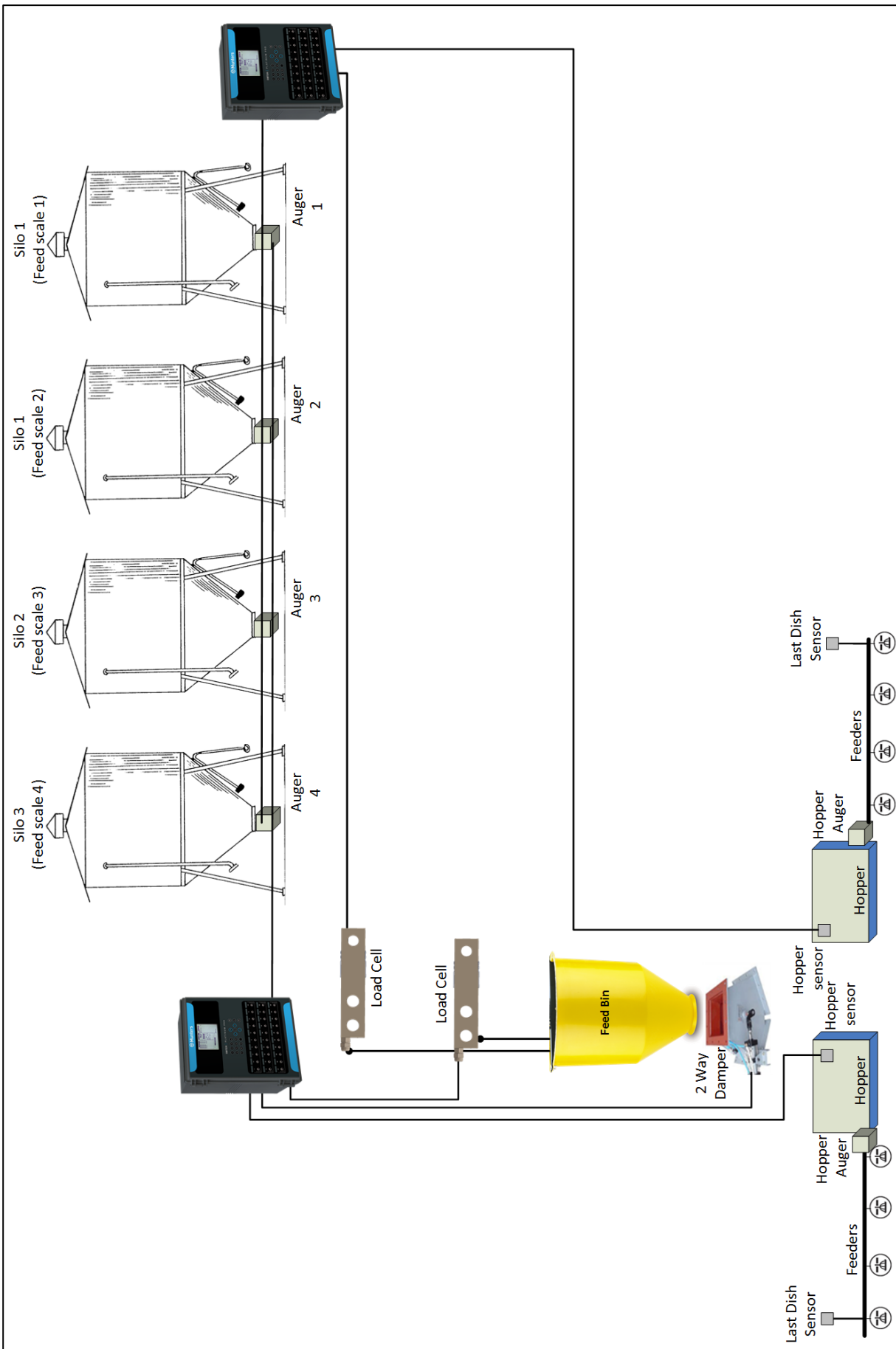

Figure 11: Feed scale block diagram



To set up the Feed Scales:

➤ Refer to the Installation manual on wiring the Controllers to the Feed Scale and Load Cells.

1. Go to *System > Relay Layout*.
2. Define a relay as Feed S. Active.

Relay Layout				
Relay No.	Device	No.	N.C.	
↳ Card 2 Main Slot 2				
11	Feeder	1	<input type="checkbox"/>	
12	Auger	1	<input type="checkbox"/>	
13	Feed Line Up	1	<input type="checkbox"/>	
14	Feed Line Down	1	<input type="checkbox"/>	
15	Drink Line Up	1	<input type="checkbox"/>	
16	Drink Line Down	1	<input type="checkbox"/>	
17	As Analog Out	1	<input type="checkbox"/>	
18	Feed Scale Active	1	<input type="checkbox"/>	
19	Auger	2	<input type="checkbox"/>	
20	Curtain Open	1	<input type="checkbox"/>	
↳ Card 3 Main Slot 3				

3. Go to *System > Digital Sensor*.

4. Define one sensor as Hopper Sensor and one sensor as Feed Scale Interlock.

Sensors			
Analog		Digital	
Output No.	Function	Sensor No.	
↳ Card 1 Main Slot 1			
1	Water Meter	1	
2	Feed Count	1	
3	Low Water S.Pressure	1	
4	Hopper	1	
5	Intermediate	1	
6	Feed Scale Interlock	1	
7	None	0	
8	None	0	
9	None	0	

### 3.18 Light Dimmers

Platinum Touch/One supports configuring up to five RLED 2.0 Light Dimmers from the Platinum Touch/One screen. RLED 2.0 can be connected via a Platinum Touch/One communication card or via an analog output card. Each RLED 2.0 has two independent channels; meaning five RLED 2.0 units fulfill the role of ten light channels.

**NOTE** Verify that UI Server Version/Client Version is 3.2.1 or higher. Update the software if required.

- ➔ Install the units before attempting to configure the RLED 2.0s. Light Dimmers only appear in the Installation Menu if RLED 2.0s are connected to the controller. Refer to the RLED 2.0 Installation Manual for details.

**NOTE** In the following screens, if an RLED 2.0 is connected to an analog output card, ~ appears next to the light line (for example: ~Light 6).

1. On the keyboard: Go to *Test > Hardware Checklist* and verify that RLED appears and that the status is OK.

HARDWARE CHECKLIST				
Card	Box	Slot	Status	Chann.
Alarm 1				1
<b>Relays</b>				40
N.O. 1	1	1	OK	10
N.O. 2	1	2	OK	10
N.O. 3	1	3	OK	10
N.O. 4	1	4	OK	10
<b>RDT5 RLED</b>				0
RLED 1	4	2	OK	2
RLED 2	4	3	OK	2
RLED 3	4	4	OK	2
RLED 4	4	5	OK	2
RLED 5	4	6	OK	2

- If the status is not OK, recheck the wiring.
- If an RLED 2.0 is connected to an analog output card
  - The RLED 2.0 appears under Analog Output.
  - The channel address is 0.

2. Go to *System > Light Dimmers*.

3. On each line and channel (for example ADD-1, CH-A), map a lighting line to an RLED 2.0 channel. In this example, there are five RLED 2.0s, controlling all 10 lighting lines.

### Light Dimmers

Address	Device
ADD-1 CH-A	Light 1
ADD-1 CH-B	Light 2
ADD-2 CH-A	Light 7
ADD-2 CH-B	None
ADD-3 CH-A	None
ADD-3 CH-B	None
ADD-4 CH-A	None
ADD-4 CH-B	None
ADD-5 CH-A	None
ADD-5 CH-B	None

- You can map the channels to the light lines in any order.

4. Go to *Control > Light*.

### Light Control

Light Feed      Light No Feed

Day	Time	Light Dimmer		
		1	2	7
1	00:00	15	15	20
0	00:00	0	0	0
0	00:00	0	0	0
0	00:00	0	0	0
0	00:00	0	0	0
0	00:00	0	0	0
0	00:00	0	0	0
0	00:00	0	0	0

5. Define the parameters as described Light, page 63.

6. The main screen now displays the active and inactive light lines.

Light Dimmer    1 15%   2 15%   7 20%

## 3.19 Water Dosing

Platinum Touch/One Version 7.20 supports specific dosing pumps used to inject additives into the water supply. From the controllers you can define the type of pump used, the additive, dosage rate, and additive amount.

### ➔ Install and map one pump to a digital input screen.

- Water Dosing Main Screen
- Water Dosing Help | Set Definitions

### 3.19.1 WATER DOSING MAIN SCREEN

*NOTE* Version 7.20 supports one pump. Version 7.22 supports up to four pumps. All pumps use the same additive and dosage rate.

1. In Install > Digital Sensor, select Pump Cycle Meter (one).
2. In Install > Digital Sensor, select Pump Additive Over (optional).
3. Repeat for each set of sensors (Version 7.22)
4. Go to Control > Water Dosing.

Pump 1	
Pump 1	Connected
Pump Type	0.8 Fixed
Additive Name	None
Dosage Rate %	0.8
Additive Amount	0

Pump 2	
Pump 2	NOT Connected
Pump Type	0.8 Fixed
Additive Name	None
Dosage Rate %	0.8
Additive Amount	0

#### 5. Define:

- Pump 1-4: This is a read only field which displays the pumps status.
- Pump Type: Select the type of pump being used.
  - 0.8 Fixed: This pump provides a fixed dosage rate (0.8%).
  - 0.3 – 2 Variable: This pump provides a variable rate between 0.3 to 2.5%.
- Additive Name: Select an option.

- Dosage Rate: If you defined the pump type as variable, define the dosage rate. Default: 0.8%
  - The dosage volume per pulse is 400 cc (water and additive). The dosage volume of the additive is 400 x the rate. For example 400 x 0.8 = 3.2 cc.
- Additive Amount: Define the number of liters of additive.

### 3.19.2 WATER DOSING HELP | SET DEFINITIONS



The screenshot shows a window titled "Dosing" with a dark header bar containing a crown icon, a refresh icon, and a close icon. Below the header, there is a light gray input field with the text "Dosing Shortage Alarm Time sec" on the left and the value "20" on the right, accompanied by a pencil icon indicating it is an editable field.

- Dosing Shortage Alarm Time (sec): Define the amount of time that must pass when additives cease to be added before an alarm is triggered. Range: 1 – 9999 seconds. 0 disables the alarm. Default: 20.

# 4 Management Menu

The following sections detail the Management Menu.

 Control	Bird Inventory	Feeders & Drinkers
 Management	Feed Inventory	Nipple Flushing
 History	Growth Day & Flock	Water On Demand
 System	Alarm Settings	Current Sense
	Alarm Reset	RDT-5 / Temp. Curve
	Fail Safe Settings	Switches & Relays
	Password	

- Bird Inventory
- Feed Inventory
- Growth Day and Flock
- Alarm Settings
- Alarm Reset
- Fail Safe Settings
- Password
- Feeders & Drinkers
- Nipple Flushing
- Water on Demand
- Current Sense
- RDT-5

## 4.1 Bird Inventory

Maintain your inventory by entering data into the controller.

Bird Inventory								
	Birds Placed	Dead Birds		Culled Birds		Birds Moved		Bird Count
		Update	Total	Update	Total	Update	Total	
♂ Male	38,000	0	1,173	0	0	0	0	36,827
♀ Female	0	0	0	0	0	0	0	0
<b>Total</b>	<b>38,000</b>	<b>0</b>	<b>1,173</b>	<b>0</b>	<b>0</b>	<b>0</b>	<b>0</b>	<b>36,827</b>

1. Enter the quantities under Birds Placed. There are separate rows for male and female. If you do not wish to keep separate data, simply enter the data into one or the other.
2. When required, enter the quantity found dead, culled, or moved. Platinum Touch/One calculates the totals and subtotals.
3. You can correct an error, so long as you correct it on the same day before midnight. After midnight, the information transfers to the [Mortality](#) Menu.

## 4.2 Feed Inventory

- Feed Inventory Main Screen
- Feed Inventory Help | Set Definitions

### 4.2.1 FEED INVENTORY MAIN SCREEN

Maintain your feed inventory by entering data into the controller.

Feed Inventory				
Date	Silo			
	1	2	3	4
10-Sep-18	5,109	0	0	0
17-Sep-18	5,692	0	0	0
23-Sep-18	11,368	0	0	0
28-Sep-18	11,433	0	0	0
02-Oct-18	10,535	0	0	0
05-Oct-18	0	11,371	0	0
08-Oct-18	11,468	0	0	0
10-Oct-18	11,420	0	0	0
12-Oct-18	9,549	0	0	0
14-Oct-18	11,336	0	0	0
<b>Total Feed</b>	<b>185</b>	<b>11,042</b>	<b>0</b>	<b>0</b>

To enter feed inventory manually:

1. Enter the date.

2. Enter the feed quantity under the silo and press **ENTER**. The cumulative total appears in the **Total Feed** row.

3. If required, click  and set the parameters.

4. Set the **Feed Alarms**.

If you have installed load cells and connected silo scales to your Platinum Touch/One, it automatically maintains feed inventory, including delivery dates and feed consumption data. You can monitor your fill system and maintain approximate feed inventory using the **Digital Inputs**. In this case, you need to enter your own delivery dates.

This information transfers to the History > **Water** and **Feed** menus daily, or optionally as often as selected (by the minute) in **History View**.

#### 4.2.2 FEED INVENTORY HELP | SET DEFINITIONS

Feed Inventory			
Total Feed In Silo-1	1000	Total Feed In Silo-2	2000
Total Feed In Silo-3	0	Total Feed In Silo-4	0
Active Silo	Silo 1		

- **Define:**
  - **Total Feed in Silo-1/ -2/ -3/ -4:** Manually change or correct the amount of feed in the silos.
  - **Active Silo:** Select the required silo for use. It is possible to select all of them.

#### 4.3 Growth Day and Flock

This menu defines the number of growth days and flock number.

Flock Number	1	Current Growth Day	4
New Flock	No		

- **Define:**
  - **Flock Number:** The controller automatically increments the group/flock number each time you choose New Flock/Group. You can edit the flock number. Since this field accepts six digits, some producers enter a flock number that is made of the day, month, and year the birds arrived.
  - **Current Growth Day:** Enter current growth day, if necessary. It is possible to enter negative growth days up to -7. If you reset the growth day for a new flock using this tool, your old history data does not clear. Use New Flock/Group function to clear out old history in preparation for new birds.



- **New Flock:** Use the new flock function on arrival of a new set of birds to set the growth day back to 1, 0, -1, or down to -7, and to clear out old history data.

## 4.4 Alarm Settings

This menu defines the various alarm settings.

### Alarm Settings

Global Alarm Delay (Sec.)	60	Alarm Reminder (Minutes, 0-Disable)	30
<b>Sensor Alarm</b>			
Sensor Low Temperature Range	0.0	Sensor High Temperature Range	50.0
Sensor Alarm-Differential From Low Alarm	0.6	Sensor Alarm-Differential From High Alarm	0.6
<b>Alarm</b>			
Alarm Test At Time: (hh:mm)	12:00	Day Of Alarm Test	Daily
Alarm Test Duration (Sec.)	0		
<b>Auger Overtime Alarm</b>			
Auger Overtime Delay (Min.)	15	Auger Off During Overtime	No

**NOTE** See [Fail Safe Setting](#).

- **Define:**
  - **Global Alarm Delay (second):** Alarms without a separate alarm delay, use this global delay before signaling the alarm.
  - **Alarm Reminder (minutes, 0-Disable):** Amount of time before a reminder is sent if the situation has not yet been corrected.

### Sensor Alarm

- **Sensor Low Temperature Range:** Sets the minimum reading a sensor can have to be considered a valid sensor reading. Sensor readings below this point are rejected. This generates a sensor out of range alarm. This does not apply to the special Circuit Breaker Sensor or Outside Temperature Sensor.
- **Sensor High Temperature Range:** Sets the maximum reading a sensor may have to be considered a valid sensor reading. Sensor readings above this point are rejected. This generates a sensor out of range alarm. This does not apply to the special Circuit Breaker Sensor or Outside Temperature Sensor.
- **Sensor Alarm-Differential from Low Alarm:** Individual sensor (or zone) alarm if any active sensor reads this much or more below the Control > Temperature Curve > Low Alarm Temperature.
- **Sensor Alarm- Differential from High Alarm:** Individual active growth area sensors alarm if they read this much or more above the Control > Temperature Curve > Low Alarm Temperature.

## Alarms

- **Alarm Test at Time (hh:mm):** Schedule the alarm test time.
- **Day of Alarm Test:** Choose **Daily** or a particular **day** of the week for the scheduled alarm.
- **Alarm Test Duration (seconds):** Enter the alarm test duration.

## Auger Overtime Alarm

- **Auger Overtime Delay (minute):** Set the maximum auger run time for your cross-fill system. If you have a monitor connected to the digital inputs programmed as Feeder-1 Overtime or Feeder-2 Overtime the Platinum Touch/One sends an alarm after this delay.
- **Feeder Off During Overtime:** Choose whether to shut the feed systems off after a feeder overtime alarm. Options:
  - No: All augers and feeders remain on.
  - YES: All augers and feeders shut down.

*NOTE If you choose **All** or **Related**, the feed system turns off and does not resume until you select **Reset Alarm** in the Management Menu.*

## Feeder Overtime Alarm

- **Feeder Overtime Delay:** Set the maximum feeder run time for your cross-fill system. If you have a monitor connected to the digital inputs programmed as Feeder-1 Overtime or Feeder-2 Overtime the controller sends an alarm after this delay.
- **Feeder Off During Overtime:** Choose whether to shut the feed systems off after a feeder overtime alarm. Options:
  - No: All augers and feeders remain on
  - All: All augers and feeders shut down.
  - Related: Only the specific auger from which the alarm originated and its feeders shut down.

*NOTE This alarm functions in the Broiler mode only.*

*NOTE Setting the Feeder Off During Overtime to All in either the Auger Overtime Alarm or the Feeder Overtime Alarm shuts down the augers and feeders, regardless of the other alarm's setting.*

## Auger Empty Alarm

- **Condition Detection Delay (sec.):** Platinum Touch/One sends an alarm when the current goes to the level set in the following parameter after this delay.
- **Below Nominal Current (%):** Send an alarm when the nominal current drops to this level.

➡ This alarm is operative only if 1) Current Sense Relays are installed and calibrated 2) augers have been calibrated.

## 4.4.1 ALARM SETTING HELP | SET DEFINITIONS

### Alarm Settings

Global Alarm Delay (Sec.)	60	Alarm Reminder (Minutes, 0-Disable)	30
<b>Sensor Alarm</b>			
Sensor Low Temperature Range	0.0	Sensor High Temperature Range	50.0
Sensor Alarm-Differential From Low Alarm	0.6	Sensor Alarm-Differential From High Alarm	0.6
<b>Alarm</b>			
Alarm Test At Time: (hh:mm)	12:00	Day Of Alarm Test	Daily
Alarm Test Duration (Sec.)	0		
<b>Auger Overtime Alarm</b>			
Auger Overtime Delay (Min.)	15	Auger Off During Overtime	No

- **Define:**

- **Advanced Alarms:** When selecting YES, the following additional alarms appear on the ALARM SETTINGS screen (press MENU and then ENTER to reenter the screen).

### Water on Demand Alarms

- **High/Low Pressure Diff (PSI):** Sends an alarm when the difference between the current WOD pressure and the defined pressure reaches these levels. 0 means that the alarm is disabled.
- **Shutdown Pressure Diff (PSI):** Shuts down the Water on Demand system when the pressure reaches this level.
  - Shutdown pressure must be equal to or higher than the High/Low Pressure Difference.
  - However, to disable this alarm set it to 0 (zero), even if the High/Low Pressure is above 0.

### Feed Alarms

- **Allow Feed Alarm From/To (hh:mm):** Set a starting time from which the controller can send feed shortage alarms.
- **Low Feed Alarm Limit:** Alarm if feed in Silo 1/2/3/4 is below this limit and time is within the From and To limits.
- **Feed Alarm Limit (per hour):** An alarm is generated if the feed flow is greater than this amount. This alarm is activated when a problem arises inside the barn (as opposed to when something happens to the feed scale).

### Water Overflow Alarms

- **Overflow According to Light Table:** Change overflow alarm level when the lights are off.

- **First Day Curve for Overflow:** Overflow on the FIRST day applies to the first day operation. You can define a first day at which to start increasing the overflow limit automatically. Days prior to the 'First Day' use the First Day overflow limit; days following the first day have an incremental curve toward the LAST DAY OVERFLOW parameter setting.
- **Overflow on First Day (per minute):** Number of gallons/liters per minute that generates an overflow alarm on the first day.
- **Last Day Curve for Overflow:** Set the maximum overflow limit (gallons/liters) for those days following the last curve day.
- **Overflow on Last Day (per minute):** Number of gallons/liters per minute that generate an overflow alarm on the last day.
- **Overflow At Dark (per minute):** Select overflow limit. When it is dark, the controller checks every minute.
- **Overflow Alarm Delay (minute):** Define delay time before the controller generates an overflow alarm.
- **Extra Delay At Light Start (minute):** When the first light appears, define the number of minutes before the controller begins to operate according to the set Overflow for that day.
- **Fogger Water Overflow (per minute):** Define the water overflow for foggers (gallons/liter per minute).
- **Water Off During Overflow (Version 7.23):** Choose whether to shut the water off after a water overflow alarm. Options:
  - No: Water lines remain on
  - Yes: When a water meter sends an alarm, the corresponding water line turns off.

### Water Shortage Alarms

- **Allow Water Shortage Alarm From/To:** Set the period for which the controller generates water shortage alarms.

*NOTE In Version 7.23, Water Shortage Alarms are only sent during the times when the water lines are operating. Water operation times are defined in Water & Feed Control, page 58.*

- **Shortage During Lights Off:** Select whether the water shortage alarm is disabled when all lights are out.
- **Quantity for Shortage (Per min):** Minimum flow rate that must be maintained or a water shortage alarm is generated.
- **Shortage Alarm Delay (minutes):** Minimum period of time that the shortage must extend through before generating an alarm.
- **Shortage Start Day:** Define on what day shortage alarms begin. This parameter prevents false alarms caused by young birds' low water usage. Default: 0 (meaning alarms function normally throughout the growth cycle).

### Bird Scales Alarms

- **Allow Bird Scale Alarms From/To:** Set time frame for which the controller begins and ends generating alarms for the bird scale.

## Auxiliary Alarms

- Assign auxiliary alarms in the System menu. Note that digital sensors, auxiliary alarm input with related relay must always match their relay status.
  - **Related Relay For Aux Alarm 1/2/3/4:** Relay for Auxiliary Alarm 1/2/3/4.
  - **Auxiliary Alarm Delay (sec):** Separate from the Global Alarm Delay. If there is a dry contact, the alarm is sent after the defined AUX. Alarm Delay.
  - **Aux Alarm D.I. Contact:** Alarm contacts can operate in Normally Open or Normally Closed format. **Normally Open** relays close where energy is applied; if current is interrupted, the relay opens and an alarm is sent. **Normally Closed** relays open when voltage is applied; when current is interrupted the relay closes and an alarm is sent. By default, Auxiliary Alarms are defined as NO.

## Circuit Breaker Alarm

- **Temperature for Circuit Breaker Alarm:** Set circuit breaker alarm temperature.

## CO2 Sensor Alarm

- **CO2 High Level:** Set the maximum allowed CO2 level above which an alarm is sent. The alarm ceases when the CO2 drops below this level. If the user acknowledges the alarm, the alarm messages temporarily cease (for the reminder time).

## Humidity Sensor Alarm

- **Humidity Alarm Enabled:** Mark this parameter as Yes to enable the Humidity High Level alarm and the Humidity Sensor Fail alarm
- **Humidity High Level Alarm:** Set the maximum allowed humidity level above which an alarm is sent. The alarm ceases when the humidity drops below this level. If the user acknowledges the alarm, the alarm messages temporarily cease (for the reminder time).

## Ammonia Alarm

- **Ammonia High Level:** Set the ammonia level at which an alarm is sent.

## Secondary Alarms

- **Enable Secondary Alarms:** Refer to Prioritizing Alarms, page 90.

## Potentiometer Alarm

- Enable potentiometer alarms, which send an alarm when vent/curtain potentiometer-controlled devices fail. To enable, set the time frame. If the from/to times are set to 0:00 (default) the alarm is disabled.

## Low Light Intensity Alarm

- **Low Light Alarm Enabled:** Alarm sent when the measured light is less than 50% of the requested LUX target.
- Version 7.20 supports this alarm. It is active only when a LUX sensor is installed and the alarm is enabled. In addition, the dimmer output value

must be set to maximum output for the corresponding active light program line.

### Auger Under Runtime

- Auger Under Runtime (hours): Define augers as required. Define a digital sensor as Auger Overtime Sensor. If the alarm contactor does not turn on within the time defined in this parameter, an alarm is generated. (Version 7.22)

#### 4.4.2 PRIORITIZING ALARMS

Platinum Touch/One enables prioritizing alarms. When enabled:

- ventilation-related alarms are defined as critical. The main alarm relay will transmit these alarms to the device wired to the relay (for example, a dialer).
- non-ventilation alarms are defined as non-critical. A secondary relay will transmit alarms to another device (for example, an ELS).

To prioritize alarms:

1. Go to System > Relay Layout.
2. Define a relay as Alarm (N.C.).
3. Go to Manage > Alarm Setting > Help
4. Enable Advanced Alarms.
5. Go to Manage > Alarm Setting.
6. Scroll to Secondary Alarms and define as Yes.

#### 4.5 Alarm Reset

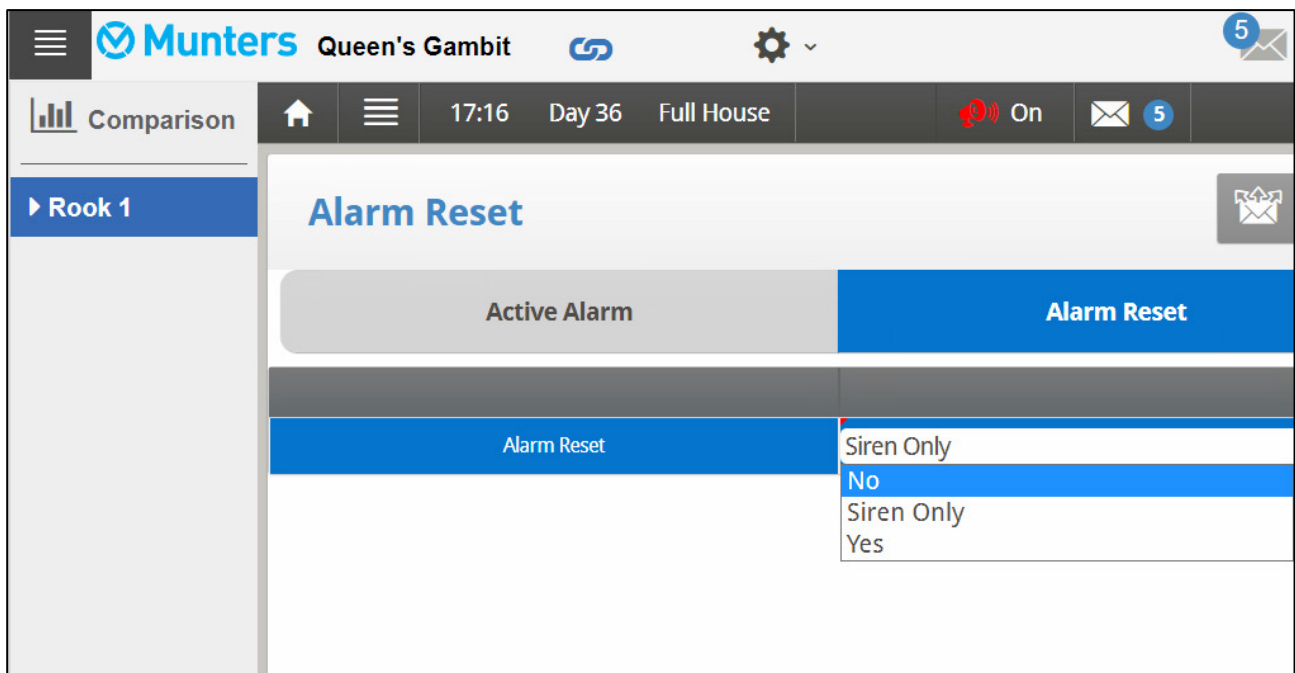

This menu functions as an alarm reset.

- **Alarm Reset:** Mark the box if you want to reset alarms. Enabling the reset:

- Clears the alarm relay for all current alarms. The alarms may remain valid, but the unit does not register new alarms. If a new alarm occurs, or an existing alarm clears and reoccurs, the alarm relay signals again (after any appropriate delay).
- Restores normal operation after an emergency pressure or feed overrun incident. If the controller experiences a high-pressure alarm for too long, it enters emergency pressure operation by opening all known air sources. Curtains open to preset amounts as set in Control > [Static Pressure](#). If you select SIREN ONLY, the alarm relay returns to the no alarm condition, but the emergency pressure status continues.
- Restores normal operation after a feed overrun situation that calls for turning off the feeding system. If the feed monitor senses the cross auger runs too long, it trips a feed overrun alarm and optionally turns off the feed system. If you select SIREN ONLY, the alarm relay returns to the no alarm condition, but the feed overrun status continues.

## 4.6 Fail Safe Settings

When there is a problem such as extremely high air temperature, the Fail-Safe function immediately activates a backup system (for example the RBU-27) to ensure that adequate ventilation continues.

### Fail Safe Settings

High Temperature <input type="radio"/> No	Low Temperature <input type="radio"/> No
Low S.Pressure <input type="radio"/> No	High S.Pressure <input type="radio"/> No
Avg Temperature Fail <input type="radio"/> No	Auxiliary (Dry Contact) <input type="radio"/> No
High CO2 <input checked="" type="radio"/> Yes	

The Platinum Touch/One has six options besides controller failure or power off to activate the fail-safe relay.

- **High/Low Temperature:** Select to trigger fail-safe when the temperature is exceptionally high/low.
- **Low/High Static Pressure:** Select to trigger fail-safe when the static pressure is exceptionally low/high.
- **Avg. Temperature Fail:** Select to trigger fail-safe when all sensors in house fail.
- **Aux. (Dry Contact):** Select to trigger fail-safe when auxiliary dry contact occurs.
- **High CO2:** Select to activate fail-safe when the measured CO2 levels rise above permitted levels (Version 7.24 and above).

## 4.7 Password

Password			
Owner	-----	User 1	-----
User 2	-----	User 3	-----
User 4	-----	User 5	-----
Visitor	-----		

- The users can access the controller and make changes to all controller settings and their own password. A user can only see and change the user's own password.
- The visitor can access the controller but cannot make changes. Each time someone accesses the controller with a password, an event is recorded in the [Events Log History](#)

*NOTE If your controller uses passwords, the controller also requires a password entry to acknowledge switch position changes. If the switch change is not acknowledged the controller signals an alarm.*

## 4.8 Feeders & Drinkers

This selection enables inserting relevant information regarding feeder and drinker lines.

- Feeders & Drinkers Main Screen
- Feeders & Drinkers Help | Set Definitions

### 4.8.1 FEEDERS & DRINKERS MAIN SCREEN

- Version 7.18 or below: Define at least one of the following pairs:
  - Feed Line Up/Down
  - Feeder Window Open/Close
  - Drink line Up/Down
- Version 7.19: Define at least one of the following relays (a pair is not required):
  - Feed Line Up/Down
  - Feeder Window Open/Close
  - Drink line Up/Down

Feeders & Drinkers			
Day	Window Pos. (%)	Feeder-Line Lift	Drinker-Line Lift
1	10	2.0	2.0
5	10	3.0	3.0
0	0	0.0	0.0



1. In *System > Relay Layout*, define at least one set of relays as Feed Line Up/Down or Drink Line Up/Down.





2. Define:

- Day: Insert day number.
- Window Pos (%): Insert the percentage of window's position
- Feeder-Line Lift (inch): Define the specific feed line lift, measured in inches.
- Water-Line Lift (inch): Define the specific drinker line lift, measured in inches.



3. If required, click  and set the parameters.

## 4.8.2 FEEDERS & DRINKERS HELP | SET DEFINITIONS

Feeders & Drinkers - Settings	
Stop Feed Before Adjust (Minute)	60 
Time From Close To Open (Sec.)	15 
<b>Feed Line</b>	
Movement Time Per 10 (sec)	0 
<b>Drinkers Line</b>	
Movement Time Per 10 (sec)	0 

• Define:

- Adjust at Time: Set the required time to adjust the feeders' and drinkers' positions.

### Feeder Window

- Stop Feed Before Adjust (Min): Set the amount of time to stop feeding before adjustment begins.
- Time from Close to Open (sec): Set the amount of time after stopping the feeding before opening the feeder's window.

### Feed Line

- Movement Time per 10 inches (sec): Set a number of seconds needed to move the feed line 10 inches.

### Drinkers Line

- Movement Time per 10 inches (sec): Set a number of seconds needed to move the water line 10 inches.

## 4.9 Nipple Flushing

1. Go to *System > Relay Layout*.

2. Define:

- Water Main: The control's supplementary for the usual water line.

- Water Bypass: The control's supplementary to bypass the water pressure regulator.
- Water line 1 through 122 Water line 10: Individual water line supplementary to select the line to flush.

#### 4.9.1 SCHEDULING THE FLUSH

**Nipple Flushing**

Schedule Order

Nipple Flush		
Start Time	On Time (Min)	Status
00:00	0	Stop Auto Manual
00:00	0	Stop Auto Manual
00:00	0	Stop Auto Manual
00:00	0	Stop Auto Manual
00:00	0	Stop Auto Manual
00:00	0	Stop Auto Manual
00:00	0	Stop Auto Manual
00:00	0	Stop Auto Manual
00:00	0	Stop Auto Manual
00:00	0	Stop Auto Manual

1. Configure up to 20 flush times.
2. Set the water flushing start time and duration (water lines as defined by relay layout).

#### 4.9.2 FLUSHING ORDER

➡ Define relays as Water Lines before configuring this screen.

**Nipple Flushing**

Schedule Order

	Sunday	Monday	Tuesday	Wednesday	Thursday	Friday	Saturday
Line	1	---	---	---	---	---	---
Order	2	---	---	---	---	---	---

- Define:
  - **Line:** Set flushing according to line/order.
  - **Order:** Set flushing per day.

#### 4.9.3 NIPPLE FLUSHING BY TEMPERATURE

Version 7.20 supports nipple flushing by temperature, in which the flushing only takes place when the water temperature in the pipes reaches a certain temperature. This function requires one water temperature sensor per house:

- Water Temperature Sensor PTC:
  - 1V (4 mA) = -40° C
  - 5V (20 mA) = 60° C
- Munters Water Temperature Sensor

*NOTE Refer to the Installation Manual for details on installing these products.*

To configure nipple flushing by temperature:

1. In System > Sensor > Analog, define one sensor as Water Temp PTC and one sensor as Water Temp NTC.
2. In System > Relay Layout, define the required number of relays as Water Line.

3. Go to Management > Nipple Flushing and click  to set the parameters.

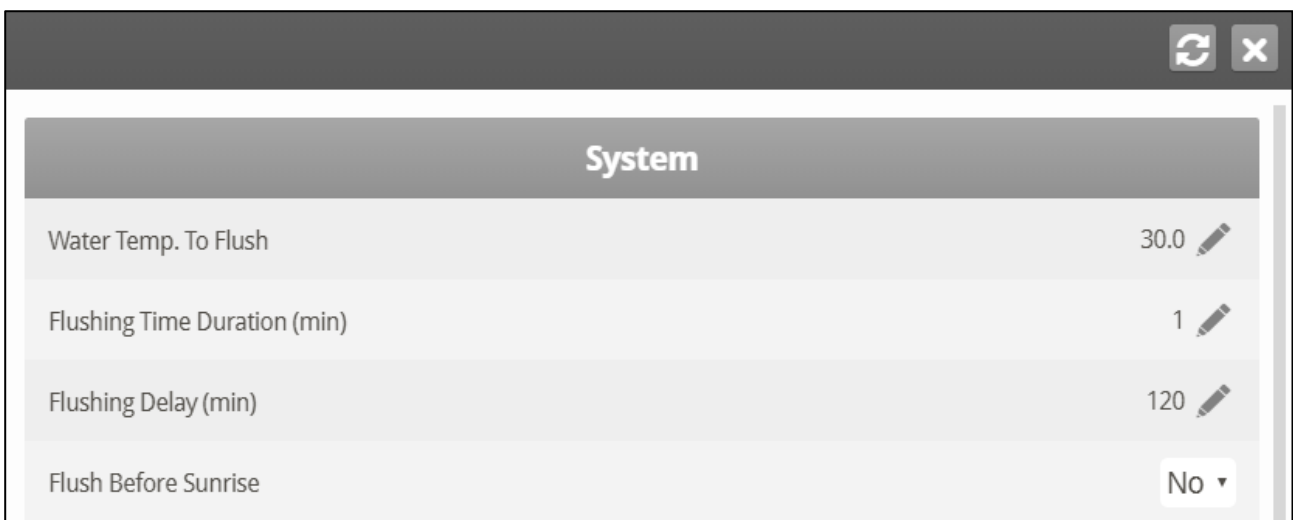

4. Define:

- Water Temp to Flush: Water temperature at which flushing begins.
- Flushing Time Duration (min): Default 1 minute. Range: 0 - 250
- Flushing Delay (min): Default 120. Range: 1 - 999
- Flush Before Sunrise: Yes or No. Day is defined as when the light intensity reaches 70% of the intensity in the Light Table (refer to Light, page 63).

*NOTE These parameters appear even if water temperature sensors are not installed, but in that situation they are irrelevant.*

#### 4.10 Water on Demand

The Water on Demand (WOD) function enables regulating the pressure of all nipple lines in the house from one central point, ensuring uniform pressure in all lines. The function also enables immediate transitioning between different preset pressures of all nipple lines in the house by closing and opening of valves at the central point (manual or solenoid according to the mode installed).

Platinum Touch/One enables controlling the water cycle times using relays and controlling the water pressure using analog input and output sensors. The two methods are complimentary. A user can use either one alone or both.

➤ Define at least one relay as Water on Demand.

- Relay Control
- Sensor Control
- Water on Demand Help | Set Definitions

#### 4.10.1 RELAY CONTROL

Specify up to 50 time periods.

Water On Demand				
Day	Time	Relays		
		1	2	3
1	08:00	<input checked="" type="checkbox"/>	<input type="checkbox"/>	<input type="checkbox"/>
5	08:00	<input checked="" type="checkbox"/>	<input checked="" type="checkbox"/>	<input type="checkbox"/>
10	06:00	<input checked="" type="checkbox"/>	<input type="checkbox"/>	<input type="checkbox"/>
0	00:00	<input type="checkbox"/>	<input type="checkbox"/>	<input type="checkbox"/>
0	00:00	<input type="checkbox"/>	<input type="checkbox"/>	<input type="checkbox"/>

1. In *System > Relay Layout* designate up to four relays as WOD valves.
2. In *Management > Water on Demand*, define:
  - **Day:** Specifies the day to activate the selected WOD valve. You can define days as negative days.
  - **Time:** Specifies the time to activate the enabled valves. The valves continue running until the next scheduled day and time. Specify up to 50 time periods.
  - **Relays:** Enable the required relays.
3. Set the **WOD alarms**.

#### 4.10.2 SENSOR CONTROL

Water On Demand						
Day	Time	Relays				Pressure
		1	2	3	4	
1	08:00	<input checked="" type="checkbox"/>	<input type="checkbox"/>	<input type="checkbox"/>	<input type="checkbox"/>	1.00
5	08:00	<input checked="" type="checkbox"/>	<input checked="" type="checkbox"/>	<input type="checkbox"/>	<input type="checkbox"/>	1.00
10	06:00	<input checked="" type="checkbox"/>	<input type="checkbox"/>	<input type="checkbox"/>	<input type="checkbox"/>	2.00
0	00:00	<input type="checkbox"/>	<input type="checkbox"/>	<input type="checkbox"/>	<input type="checkbox"/>	0.00
0	00:00	<input type="checkbox"/>	<input type="checkbox"/>	<input type="checkbox"/>	<input type="checkbox"/>	0.00
0	00:00	<input type="checkbox"/>	<input type="checkbox"/>	<input type="checkbox"/>	<input type="checkbox"/>	0.00
0	00:00	<input type="checkbox"/>	<input type="checkbox"/>	<input type="checkbox"/>	<input type="checkbox"/>	0.00

To add precision measurements:

1. In *System > Analog Output*:
  - a. designate one output device as WOD.

- b. set the minimum input and output voltages.
2. In *System > Sensors > Analog*, designate one sensor as Water of Demand Pressure. This setting enables a sensor to measure the water flow.
  3. In *Management > Water on Demand*, configure the following parameters:
    - **Day:** Specifies the day to activate the selected WOD valve. You can define days as negative days.
    - **Time:** Specifies the time to activate the enabled valves. The valves continue running until the next scheduled day and time.
    - **Relays:** Enable the required relays.
    - **Pressure:** Specifies the required water pressure. The unit that appears is the unit defined in *System > Setup* (pressure unit) (page [Setup](#)).
  4. If required, click  and set the parameters.
  5. **Using the Keyboard:** In *Service > WOD Calibration*:
    - a. Enter the first pressure and voltage data points.
    - b. Repeat for second data point.
  6. Set the WOD alarms in [Water on Demand Alarms](#).

### 4.10.3 WATER ON DEMAND HELP | SET DEFINITIONS

These parameters define the feed and water delivery schedule through the week.



- **Define:**
  - **Water Pressure During Flush:** Designate the system water pressure when nipple flush is operative.
  - **Relay Active During Flush:** Designate which WOD relays remain active during flushing.

## 4.11 Current Sense

TBD

## 4.12 RDT-5

- Configuring the RDT-5
- RDT-5 / Temperature Curve | Set Definitions
- RDT-5 Digital Alarm
- Saving and Loading RDT-5 Tables
- RDT-5, Version 7.22

### 4.12.1 CONFIGURING THE RDT-5

- Munters' RDT-5 is a five-stage digital thermostat that works in conjunction with Platinum Touch/One Controllers or as a stand-alone unit. When wired to the Platinum Touch/One, you can use the Platinum Touch/One to set the RDT-5's stage activation temperatures (which is easier than setting the temperatures on the RDT-5 screen). The stage activation temperature determines when cooling and heating operations take place. RDT-5 supports a 10-point temperature curve.
- Version 7.20 supports two RDT-5 units.
  - If your system includes two RDT-5 units, verify that the controller identifies both in Hardware Checklist, page 114.
  - Ensure that each unit has a unique address (refer to the RDT-5 Manual for details).
  - After installing the RDT-5 units, perform a Cold Start.

RDT-5 / Temp. Curve						
Day	Temp	Stage 1 COOL	Stage 2 HEAT	Stage 3 COOL	Stage 4 HEAT	Stage 5 HEAT
0	0.0	--	--	--	--	--
0	0.0	--	--	--	--	--
0	0.0	--	--	--	--	--
0	0.0	--	--	--	--	--
0	0.0	--	--	--	--	--
0	0.0	--	--	--	--	--
0	0.0	--	--	--	--	--
0	0.0	--	--	--	--	--
0	0.0	--	--	--	--	--
0	0.0	--	--	--	--	--
0	0.0	--	--	--	--	--
--	--	Stage 1	Stage 2	Stage 3	Stage 4	Stage 5
--	--	-2.0	-5.0	2.0	5.0	7.0

➔ Wire the Platinum Touch/One communication card to the RDT-5's communication card. Refer to the RDT-5 manual for details.

1. In System > Communication, define the expansion device as Dig. Thermostat.
2. In Management > RDT-5 / Temp. Curve, define the parameters (up to a 10-point curve).
  - Day: The growth day

- **Temp.:** The target temperature for that day.
- **Stage 1 – 5:** The temperatures at which heating or cooling starts (read only)
- **RDT-5 Stage Difference:** The differences from the target temperature at which heating or cooling starts at each stage (read only; set these numbers in the Help).

Platinum Touch/One automatically calculates and displays the stage activation temperatures.

**CAUTION** *Verify that the RDT-5's growth day and the controller's growth day are the same! Days set differently means that the temperature curves will be asynchronous.*

3. In RDT-5 / Temperature Curve> Set Definitions, define the parameters as required.

Notes:

- Platinum Touch/One does not store these temperatures; RDT-5 does. If you connect the Platinum Touch/One to a different RDT-5 unit, you must re-enter the temperature curve.
- If you previously defined the temperature curve in the RDT-5, Platinum Touch/One retrieves the data and you can edit the data in this screen.
- When connecting the RDT-5 to a Platinum Touch/One Controller:
  - If an Expansion box is currently connected to the controller, a message appears in the Message box when you disconnect the Extension box. However, no alarm is sent out.
  - After configuring the RDT-5, disconnect the unit from the Platinum Touch/One and reconnect the Extension box. If the Extension box is not reconnected, Platinum Touch/One sends out alarms.

#### 4.12.2 RDT-5 / TEMPERATURE CURVE | SET DEFINITIONS



- Define the parameters as required:
  - **Stage 1 – 5 Diff:** Enter the difference from the target temperature that activates a heater or cooler for each stage. These numbers appear on the RDT-5 / Temperature Curve screen.
  - **Stage 1 – 5 Type:** Select Heat or Cool. Each RDT-5 relay serves as a heater or cooler relay. This parameter enables displaying the relay definition on the screen.

**CAUTION** *Selecting Heat or Cool in this screen does not define the relay; it only displays the relay type. Actual relay definition is done in the RDT-5 unit, by placing a*

*jumper on certain pins. Meaning: if a relay is defined in this screen as a heater, but the jumper placement defines the relay as a cooler, the relay is a cooler. Refer to the RDT-5 manual for details.*

### 4.12.3 RDT-5 DIGITAL ALARM

If required, define up to two digital sensors to send an alarm noting that an RDT-5 is functioning. Refer to Digital Sensors, page 128.

Connect the RDT-5 Backup Active Port to the controller's digital input card. Refer to the installation manual.

**CAUTION** *Verify that the input port defined in System > Digital Sensors matches the port on the digital input card used to connect the units!*

### 4.12.4 SAVING AND LOADING RDT-5 TABLES

In Version 7.19, the Platinum Touch/One controllers store (backup) the RDT-5 temperature curve tables. This function enables transferring the tables from a configured RDT-5 to another, unconfigured RDT-5.

To transfer settings:

1. Wire a RDT-5 unit to the controller, perform a [Cold Start](#) (page 15), and define the temperature curve on the RDT-5 or on the controller (see the above sections).
2. Save the controllers settings to an SD card. Refer to Save Settings, page 153 for details.
3. Connect the second RDT-5 unit to the controller and perform a [Cold Start](#)
4. Upload settings from the SD card. Refer to Load Settings, page 154 for details. Verify that you are uploading the correct file!

**NOTE** *If there is any interruption while uploading settings, the tables may not transfer. In this case, a message will appear informing you of the issue.*

### 4.12.5 RDT-5, VERSION 7.22

In Platinum Touch Version 7.22.01, the growth day and days in the temperature curve can be set to -7 & up. RDT-5 Version 1.5.8 also supports this feature. However, if, when used together one of the products is operating using legacy software, there can be operational errors. The following table explains possible errors if the growth day and RDT-5 temperature curve days are defined as negative days when using legacy software for either product.



	Platinum Touch V7.22	RDT-5 Ver 1.5.8
Platinum Touch V7.21		Negative days in the RDT-5 appear incorrectly. RDT-5 functions may not operate properly.
RDT-5 Ver < 1.5.8	Negative days are not transmitted to the RDT-5. Both units operate as if they are operating using legacy software.	

**CAUTION** Munters recommends that users who employ RDT-5 units update that product's software when you update the Platinum Touch/One software to version 7.22.

# 5 History Menu

🔑 Control	Temperature	Mortality	History View
📁 Management	Humidity	Heaters	Ammonia
⌚ History	CO2	Radiant Heaters	Dosing
🔧 System	Bird Weight	Variable Heaters	
🔗 EXT System	Feed Conversion	Alarms	
	Water	Table Of Events	
	Feed	Power Consumption	

In the History Menu you can view data regarding:

- Temperature History
- Humidity History
- CO2 History
- Feed Conversion
- Water Consumption History
- Feed Consumption History
- Mortality
- Heaters History
- Radiant Heaters History
- Variable Heaters History
- Table of Events
- Power Consumption
- History View
- Ammonia History
- Dosing History

## 5.1 Temperature History

The temperature history menu stores minimum, average and maximum temperatures by growth day. The average is weighted, so if most of the day has been warm the average is closer to the maximum than the minimum.

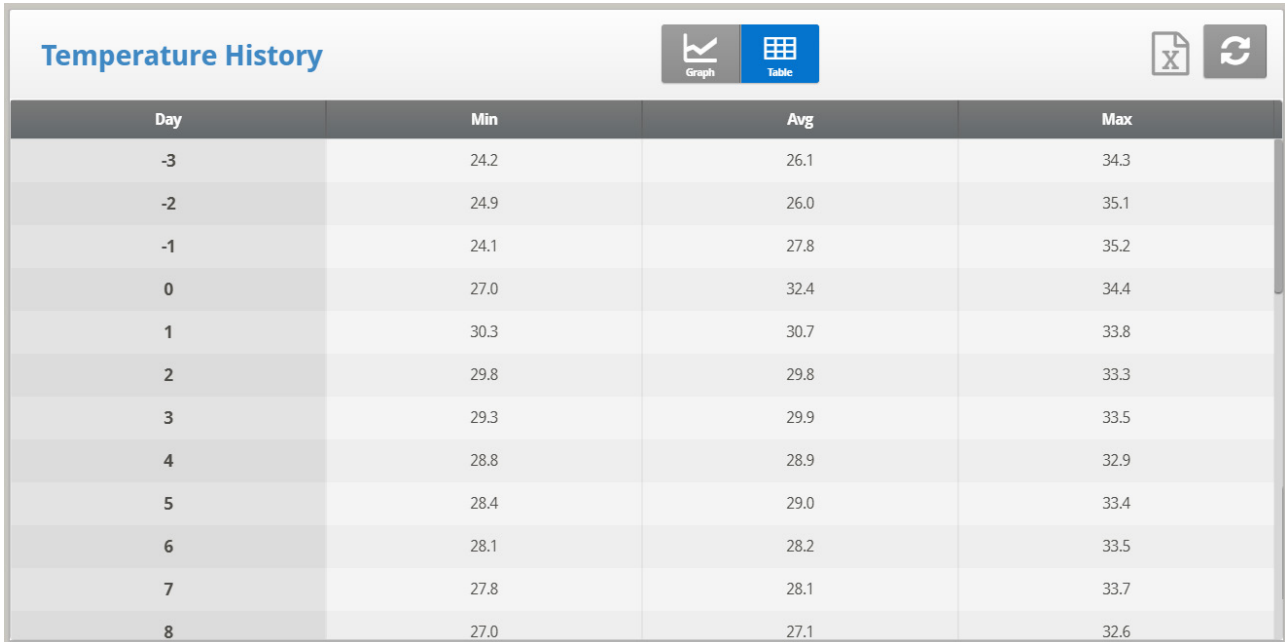

Day	Min	Avg	Max
-3	24.2	26.1	34.3
-2	24.9	26.0	35.1
-1	24.1	27.8	35.2
0	27.0	32.4	34.4
1	30.3	30.7	33.8
2	29.8	29.8	33.3
3	29.3	29.9	33.5
4	28.8	28.9	32.9
5	28.4	29.0	33.4
6	28.1	28.2	33.5
7	27.8	28.1	33.7
8	27.0	27.1	32.6

## 5.2 Humidity History

The humidity history menu stores minimum, average and maximum inside humidity by growth day. The average is weighted, so if most of the day has been humid the average is closer to the maximum than the minimum.

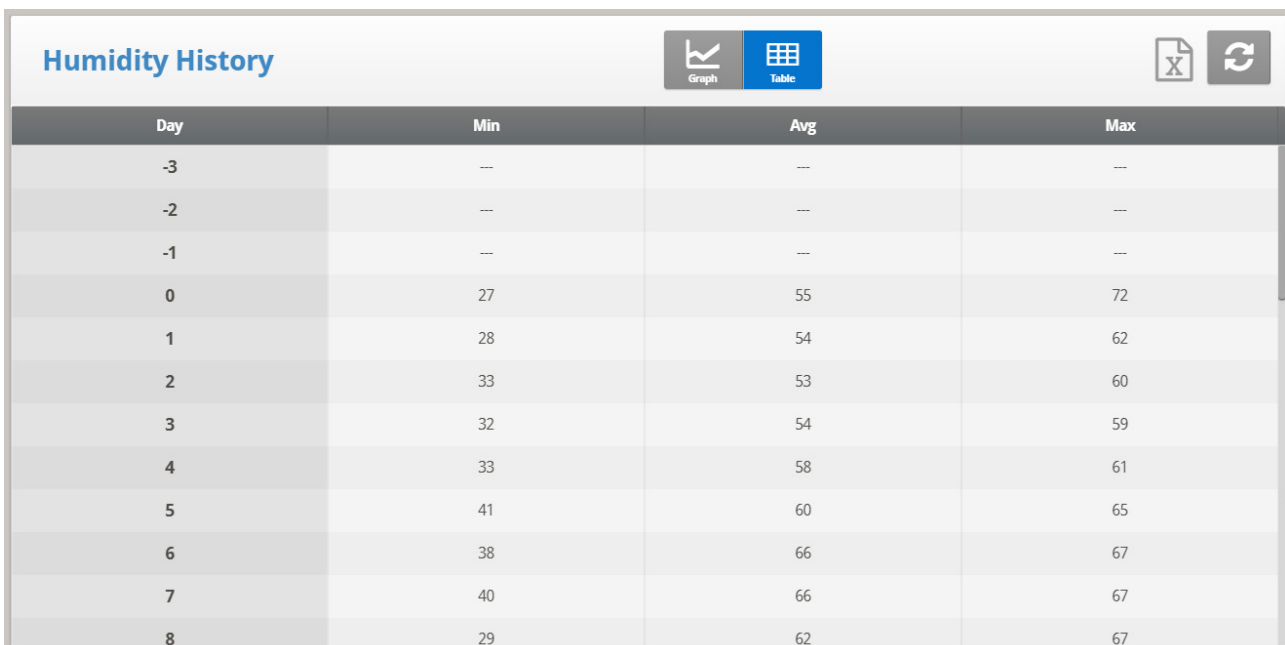

Day	Min	Avg	Max
-3	--	--	--
-2	--	--	--
-1	--	--	--
0	27	55	72
1	28	54	62
2	33	53	60
3	32	54	59
4	33	58	61
5	41	60	65
6	38	66	67
7	40	66	67
8	29	62	67

**NOTE** If two humidity sensors are installed, this screen displays their average. The History View display shows reading of both sensors only if they have been selected for logging.

### 5.3 CO2 History

The CO2 history menu stores minimum, average and maximum inside CO2 levels by growth day. The average is weighed, therefore if most of the day has high CO2 levels the average is closer to the maximum than the minimum. If two sensors are installed (Version 7.20) data points show the average of both sensors.

CO2 History			
Day	Min	Avg	Max
21	1362	1368	1825
22	1137	1274	1537
23	1212	1337	1450
24	1256	1261	1400
25	1131	1181	1268
26	1062	1149	1200
27	1131	1312	1781
28	1225	1342	1675
29	1275	1562	1812

### 5.4 Bird Weight History

The scale history shows bird weight statistics. You can review daily data for each scale, or separately. The unit records up to two-bird scale data; if you have more than one scale-1 or one scale-2, their data is combined.

Bird Weight History										
Day	Common				Scale 1				Scale 2	
	Average	Daily Gain	Uniformity	No.	Average	Daily Gain	Uniformity	No.	Average	Daily Gain
1	0.000	0.000	0	0	0.000	0.000	0	0	0.000	0.000
2	0.000	0.000	0	0	0.000	0.000	0	0	0.000	0.000
3	0.000	0.000	0	0	0.000	0.000	0	0	0.000	0.000
4	0.000	0.000	0	0	0.000	0.000	0	0	0.000	0.000
5	0.000	0.000	0	0	0.000	0.000	0	0	0.000	0.000
6	0.000	0.000	0	0	0.000	0.000	0	0	0.000	0.000
7	0.000	0.000	0	0	0.000	0.000	0	0	0.000	0.000

- The Daily Gain shows difference between the current average weight and the previous day's average weight; the data comes from all the scales.
- No daily gain is shown for individual scales.

## 5.5 Feed Conversion

This screen displays the amount of feed converted into the bird's weight.

Feed Conversion History			
Day	Bird Weight	Daily Feed	Feed Conversion
22	1.031	3,641.0	1
23	1.118	4,353.0	1
24	1.204	4,371.0	1
25	1.268	4,620.0	1
26	1.310	4,700.0	1
27	1.395	5,041.0	1
28	1.478	5,452.0	1
29	1.562	5,435.0	1
30	1.648	5,697.0	1
31	1.700	5,605.0	1
32	1.781	5,656.0	1
33	1.843	2,289.0	1

## 5.6 Water Consumption History

The water menu records daily water consumption and shows the daily differential change from the previous day in percent.

➡ Connect the water monitor digital inputs.

You can monitor up to two drinking water meters, total drinking water, total water, cool pad, fogger, and cool pad flush consumption. In Version 7.23, the user can monitor the water per bird.

Water Consumption History							
Day	Total Daily Water		Water/Feed Rate	Water Per Bird	Water-1		W
	Total	Change (%)			Water-1	Change (%)	
1	0	---	0.0	0.000	0	---	
2	0	0	0.0	0.000	0	---	
3	0	0	0.0	0.000	0	---	
4	0	0	0.0	0.000	0	---	
5	0	0	0.0	0.000	0	---	
6	0	0	0.0	0.000	0	---	
7	0	0	0.0	0.000	0	---	

The screen displays the:

- Amount of water consumed
- Water/Feed Rate: Daily water consumption divided by daily feed intake
- Water per bird
- Daily percentage change

## 5.7 Feed Consumption History

The feed menu records daily feed consumption and shows the daily differential change from the previous day in percent for silos or fill systems.

Feed Consumption History											
Day	Daily Feed		Feed Per Bird	Feed-1 Daily		Feed-2 Daily		Feed-3 Daily		Feed-4 Daily	
	Total	Change (%)		Feed 1	Change (%)	Feed 2	Change (%)	Feed 3	Change (%)	Feed 4	Change (%)
23	4,353	19	0.12	10	-100	4,342	349	0	---	0	---
24	4,371	0	0.12	0	-100	4,371	0	0	---	0	---
25	4,620	-63	0.13	2,991	226	1,629	-63	0	---	0	---
26	4,700	1	0.13	4,700	57	0	-100	0	---	0	---
27	5,041	7	0.14	5,041	7	0	-100	0	---	0	---
28	5,452	8	0.15	5,452	8	0	0	0	---	0	---
29	5,435	---	0.15	5,435	---	0	0	0	---	0	---
30	5,697	4	0.15	5,686	4	11	0	0	---	0	---
31	5,605	-2	0.15	5,605	-2	0	-100	0	---	0	---
32	5,656	0	0.15	5,656	0	0	-100	0	---	0	---
33	2,289	0	0.06	2,289	0	0	0	0	---	0	---

➡ Install a feed silo weighing system to use the feed system or to monitor the auger system.

The feed data can be based on one of the following inputs. If more than one input is installed, priority is according to the order of the bulleted list.

- **Silo:** If silos (load cells) are installed, feed consumption data of each bin is based on the feed bin/silo weight.
- **Current Sense:** If Current Sense Relays for Augers are installed and calibrated (refer to [Current Sense Relay Calibration](#)), feed consumption data of each auger is based on the current sense, calculation method settings, and actual auger run-time. The run-time is calculated based on the measured current when the actual current is higher than the nominal value.
- **Feed Count:** If a feed count sensor is installed feed consumption for each feed count input is based on the feed count method settings (refer to The mortality history menu maintains daily summaries of mortality, cull, and total dead. It also shows the percentage dead and gives an updated count of bird inventory. The history is maintained separately for male, female and total. Use the left and right arrow keys to switch to the next screen.

As an option, the user can monitor the feed per bird.

1. Go to History > Water > Help.
2. Enable Display History Per Bird.

## 5.8 Mortality

Mortality History									
Day	Total Mortality (%)			Total Mortality (No.)			Dead Birds		
	Female	Male	Total	Female	Male	Total	Female	Male	Total
23	0	3	3	0	0	0	0	0	0
24	0	3	3	0	12	12	0	12	12
25	0	3	3	0	5	5	0	5	5
26	0	3	3	0	8	8	0	8	8
27	0	3	3	0	22	22	0	22	22
28	0	3	3	0	14	14	0	14	14
29	0	3	3	0	23	23	0	23	23
30	0	3	3	0	20	20	0	20	20
31	0	3	3	0	13	13	0	13	13
32	0	3	3	0	18	18	0	18	18
33	0	3	3	0	5	5	0	5	5

The mortality history menu maintains daily summaries of mortality percentages, culled, and total dead. It also shows the percentage dead and gives an updated count of bird inventory. The history is maintained separately for male, female and total. Use the left and right arrow keys to switch to the next screen.

## 5.9 Heaters History

Platinum Touch/One maintains daily total run times of each heater. The data is in hours:minutes format.

Heaters History													
Hours													
Day	Heater 1	Heater 2	Heater 3	Heater 4	Heater 5	Heater 6	Heater 7	Heater 8	Heater 9	Heater 10	Heater 11	Heater 12	Heater 13
0	02:18	01:19	01:31	02:01	00:00	00:00	00:00	00:00	00:00	00:00	00:00	00:00	00:00
1	03:30	02:07	02:32	03:00	00:00	00:00	00:00	00:00	00:00	00:00	00:00	00:00	00:00
2	03:10	02:18	02:40	02:16	00:00	00:00	00:00	00:00	00:00	00:00	00:00	00:00	00:00
3	02:46	02:07	02:07	01:51	00:00	00:00	00:00	00:00	00:00	00:00	00:00	00:00	00:00
4	02:27	01:38	01:56	01:35	00:00	00:00	00:00	00:00	00:00	00:00	00:00	00:00	00:00
5	02:15	01:25	01:35	01:44	00:00	00:00	00:00	00:00	00:00	00:00	00:00	00:00	00:00
6	01:35	00:47	01:00	00:55	00:00	00:00	00:00	00:00	00:00	00:00	00:00	00:00	00:00
7	02:02	01:04	01:49	01:12	00:00	00:00	00:00	00:00	00:00	00:00	00:00	00:00	00:00
8	02:34	01:53	02:03	01:44	00:00	00:00	00:00	00:00	00:00	00:00	00:00	00:00	00:00
9	02:59	01:54	02:15	02:14	00:00	00:00	00:00	00:00	00:00	00:00	00:00	00:00	00:00
10	02:56	02:01	02:04	02:11	00:00	00:00	00:00	00:00	00:00	00:00	00:00	00:00	00:00

## 5.10 Radiant Heaters History

Platinum Touch/One maintains daily total run times of each radiant heater, including separate data for low level and high-level heaters. The table fills several screens; to view the off-screen data, use the arrow keys to scroll. The data is in hours:minutes format.

Radiant Heaters History																								
Day	Heater 1		Heater 2		Heater 3		Heater 4		Heater 5		Heater 6		Heater 7		Heater 8		Heater 9		Heater 10		Heater 11		Heater 12	
	Low	High	Low	High	Low	High	Low	High	Low	High	Low	High	Low	High	Low	High	Low	High	Low	High	Low	High	Low	
23	00:00	00:00	00:00	00:00	00:00	00:00	00:00	00:00	00:00	00:00	00:00	00:00	00:00	00:00	00:00	00:00	00:00	00:00	00:00	00:00	00:00	00:00	00:00	00:00
24	00:00	00:00	00:00	00:00	00:00	00:00	00:00	00:00	00:00	00:00	00:00	00:00	00:00	00:00	00:00	00:00	00:00	00:00	00:00	00:00	00:00	00:00	00:00	00:00
25	00:00	00:00	00:00	00:00	00:00	00:00	00:00	00:00	00:00	00:00	00:00	00:00	00:00	00:00	00:00	00:00	00:00	00:00	00:00	00:00	00:00	00:00	00:00	00:00
26	00:00	00:00	00:00	00:00	00:00	00:00	00:00	00:00	00:00	00:00	00:00	00:00	00:00	00:00	00:00	00:00	00:00	00:00	00:00	00:00	00:00	00:00	00:00	00:00



## 5.11 Variable Heaters History

The controller tracks the operating time of the variable heaters. The table fills several screens; to view the off-screen data, use the arrow keys to scroll. The data is in hours:minutes format.

Variable Heaters History								
Hours								
Day	1	2	3	4	5	6	7	8
1	00:00	00:00	00:00	00:00	00:00	00:00	00:00	00:00

## 5.12 Alarms History

The alarm history records the growth day and time of each alarm. Alarms that are currently active show up as flashing on the screen. Alarm history is not reset when using Management, Growth Date & Flock > Start New Flock. The last 250 alarms are saved, and as the table is filled, new alarms push out the older alarms.

Alarms History		
Day	Time	Message
28	10:00:00	Alarm Test
29	07:25:46	Below Minimum Air
29	10:00:00	Alarm Test
30	10:00:00	Alarm Test
31	10:00:00	Alarm Test
31	22:49:52	Below Minimum Air
32	06:07:04	Switches Changed
32	10:00:00	Alarm Test
32	13:59:12	Low Water Pressure
32	18:35:56	Low Water Pressure
33	00:01:16	Below Minimum Air
33	10:00:00	Alarm Test

### 5.13 Table of Events

The Platinum Touch/One records significant events with growth day and time stamp. The Table of Events is 1000 events long and is not reset when using Management, Growth Date & Flock > Start New Flock. New events push out the older events.

Table of Events		
Day	Time	Message
1	14:46:48	Cold Start
1	14:46:48	Min Ventilation
1	14:47:36	Data Read From Plug
1	14:47:36	Power Off
1	14:47:48	Power On
2	14:49:30	Changed Growth Day
2	15:11:52	Reset Alarm
3	10:00:00	Alarm Test
4	07:07:40	Change Silo 1 Inventory
4	07:07:40	Change Silo 2 Inventory
4	10:00:00	Alarm Test

1 - 100 of 514 items

Typical events recorded are switch changes, entry into tunnel mode, natural or minimum ventilation, alarm resets, ventilation mode changes and more. The Table of Events is an excellent tool to determine whether your controller is going in and out of tunnel due to marginal settings as well as finding and identifying problems.

### 5.14 Power Consumption

This menu displays the daily power consumption (in kWh) of the heaters, fans, lights and other equipment and the change from the previous day.

*NOTE Current sense relays are required for this function to be enabled (single phase electricity only).*

Power Consumption						
Current Sense						
Day	Heaters	Fans	Lights	Others	Total	Change (%)
22	0	0	0	0	0	--
23	0	0	0	0	0	--
24	0	0	0	0	0	--
25	0	0	0	0	0	--
26	0	0	0	0	0	--

## 5.15 History View

The History View menu has detailed history on a variety of sensors and data. Go to Help > Set under History View to select the particular data to collect.

History View							
Day	Time	Target Temp.	House Temp Min	House Temp Avg	House Temp Max	Temp 1 Avg	Temp 2 Avg
30	21:00	24.6	25.2	25.2	25.5	24.7	25.1
30	21:15	24.6	25.0	25.0	25.3	24.4	25.0
30	21:30	24.6	25.0	25.5	25.6	25.0	25.3
30	21:45	24.6	25.1	25.1	25.5	24.5	25.0
30	22:00	24.6	24.8	24.8	25.1	24.2	24.8
30	22:15	24.6	24.7	24.7	24.8	24.2	24.6
30	22:30	24.6	24.5	25.0	25.0	24.4	24.9
30	22:45	24.6	24.6	24.6	25.1	23.8	24.5
30	23:00	24.6	24.5	24.6	24.6	23.8	24.5
30	23:15	24.6	24.5	24.6	24.8	23.9	24.6
30	23:30	24.6	24.5	24.5	24.7	23.9	24.4

1. In System > Setup > History Resolution, set the frequency of your data collection. Factory default collects one-hour data on a selection from the choices below.
2. Under Help | Graph you can select a variety of graphs of the detailed history.



3. If required, click  and set the parameters.

History View - Settings					
Growth Day	<input checked="" type="checkbox"/>	Time	<input checked="" type="checkbox"/>	Target Temp.	<input checked="" type="checkbox"/>
House Temp Min	<input checked="" type="checkbox"/>	House Temp Avg	<input checked="" type="checkbox"/>	House Temp Max	<input checked="" type="checkbox"/>
Temp 1 Min	<input type="checkbox"/>	Temp 1 Avg	<input checked="" type="checkbox"/>	Temp 1 Max	<input type="checkbox"/>
Temp 2 Min	<input type="checkbox"/>	Temp 2 Avg	<input checked="" type="checkbox"/>	Temp 2 Max	<input type="checkbox"/>
Temp 3 Min	<input type="checkbox"/>	Temp 3 Avg	<input checked="" type="checkbox"/>	Temp 3 Max	<input type="checkbox"/>
Temp 4 Min	<input type="checkbox"/>	Temp 4 Avg	<input checked="" type="checkbox"/>	Temp 4 Max	<input type="checkbox"/>
Temp 5 Min	<input type="checkbox"/>	Temp 5 Avg	<input checked="" type="checkbox"/>	Temp 5 Max	<input type="checkbox"/>

The options are:



- Target Temp.
- House Temperature Minimum, Average and Maximum

- Temp – 1-6 Average
- Attic Sensor Minimum, Average and Maximum
- Outside Temperature Minimum, Average and Maximum
- Humidity In/Out Minimum, Average and Maximum
- Water Consumption
- Feed Consumption
- Level of Ventilation

*NOTE* Altering choices erases old data and starts a fresh data set.







### 5.16 Ammonia History

This screen displays the minimum, average, and maximum ammonia levels, by growth day.

Ammonia History  			
Day	Min	Avg	Max
-2	--	--	--
-2	--	--	--
-1	--	--	--
0	--	--	--

### 5.17 Dosing History

This screen displays the date, total work time, water volume transmitted, and total volume of dosage material added. Because the type of additive can be changed, the controller records each additive's history separately.

  <span>23:13</span> <span>Day 1</span> <span>Full House</span> <span> On</span> <span> 4</span> 										
Dosing 										
Day	Additive	WorkTime 1	Water 1	Dose 1	Additive	WorkTime 2	Water 2	Dose 2	Additive	Work
1	None	00:00:00	0.0	0.000	None	00:00:00	0.0	668749...	None	00:

- Version 7.22: Scroll right and left to view the history of each particular pump.

# 6 System Menu



Control	Scale Testing	Sensors	Scale Settings
Management	Hardware Checklist	Analog Output	Silo/Auger Layout
History	Setup	Temperature Definition	Munters Drive
System	Time & Date	Vent/Curt Setup	Communication
	Levels Of Ventilation	House Dimensions	Scale Layout
	Stir Fan Program	Fan Air Capacity	Version
	Relay Layout	Bird Curve	

- Scales Testing
- Hardware Checklist
- Setup
- Time & Date
- Levels of Ventilation
- Stir Fan Program
- Relay Layout
- Sensors
- Analog Output
- Temperature Definition
- Vent/Curt Setup
- House Dimensions
- Fan Air Capacity
- Setting up a Bird Weight Curve - Summary
- Non-Gender Based Weighing
- Gender Based Weighing
- Silo Setting
- Communication
- System Update

## 6.1 Scales Testing



Scale Testing  				
Type	Weight	A/D	Status	
Silo 1	862	4,743	OK	
Silo 2	44	2,778	OK	
Scale 1	0.000	29,679	OK	
Scale 2	0.000	22,332	OK	

## 6.2 Hardware Checklist

Hardware Checklist  				
Card	Box	Slot	Channel	
└ Analog Input				
Analog Input 1	Main	2	12	
└ Digital Input				
Digital Input 1	Main	1	12	
└ Analog Output				
Analog Output 1	Main	3	10	
└ Scales				
Scales 1	Main	1	2	
Scales 2	Main	2	2	
└ Static Pressure				
Static Pressure 1	Main	N/A	1	
└ Alarm				

Check the installed hardware that has been identified by the Plug and Play system. The system detects all cards except communication. The standard optional communication card provides lightning protection and does not have local computerized intelligence to identify itself to the system. Note that if a card is missing, turn the power OFF and then ON for a card rescan.

## 6.3 Setup

Setup			
Vent Mode	PRECISION	Temperature Unit	<input type="radio"/> C°
S.Pressure Unit	MM.WC ▾	Wind Speed Units	Meter/Sec ▾
Fan Air Capacity Unit	<input type="radio"/> M3/H	Length Unit	<input type="radio"/> Metric
Weight Unit	<input type="radio"/> KG	Growing Zones 1 - 4	1 
Minimum Ventilation (Power)	Yes <input type="radio"/>	Natural Ventilation	Level ▾
Tunnel	Yes <input type="radio"/>	History Resolution	15 Minute ▾

- **Define:**
  - **Static Pressure Unit:** Milibar / Inches of WC (Water Column) / Pascal / cm of WC / mm of WC / None
  - **Fan Air Capacity Unit:** Cubic feet per minute (CFM) / Cubic meter per hour (M3/H)
  - **Temperature Unit:** Celsius / Fahrenheit
  - **Wind Speed Unit:** Km Per Hour / Mile per Hour / Meter per Sec / Feet per Sec/Feet per Minute
  - **Growing Zones:** 1/2/3/4
  - **Length Unit:** Metric/ Non-Metric
  - **Minimum Ventilation:** YES (power) / NO
  - **Weight Unit:** Pounds (LB) / Kilograms (KG)
  - **Natural Ventilation:** No / Level/Progressive
  - **Tunnel:** YES / NO
  - **History Resolution:** 1 minute / 5 minute / 10 minute / 15 minute / 30 minute / 1 hour / 2 hours

### 6.3.1 STATIC PRESSURE UNIT DEFINITION





Enabling/disabling a static pressure unit determines the ventilation method used in the chicken/animal house:

- **Static pressure unit enabled:** After selecting any method, refer to [Static Pressure](#), page 48 to define the static pressure parameters.
- **No unit enabled:** If you choose **None**, ventilation is controlled by time or a potentiometer. Refer to [Vent & Curtain Levels](#), page 120.

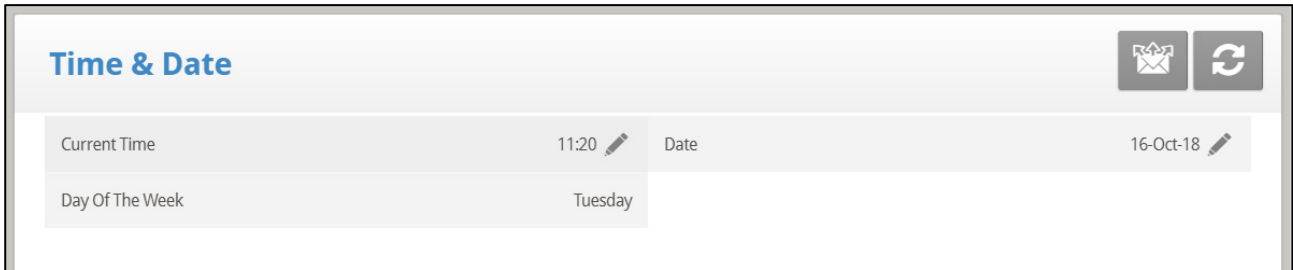
## 6.4 Time & Date

This menu sets the current time and date for the controller.



Time & Date			
Current Time	11:20 	Date	16-Oct-18 
Day Of The Week	Tuesday		

- **Define:**
  - **Current Time:** Enter the current time in 24-hour format.
  - **Current Date:** Enter the date in day-month-year format.
  - **Current Day of the Week:** Select the day of the week from the drop-down menu.

## 6.5 Levels of Ventilation

- Introduction to Ventilation
- Exhaust and Tunnel Fans
- Vent & Curtain Levels
- Variable Speed Fan Levels
- Stir and Variable Fan Levels

### 6.5.1 INTRODUCTION TO VENTILATION

Platinum Touch/One can have many closely spaced levels of ventilation enabling it to find the optimum average airflow for a poultry facility. Many of the levels are at exactly the same temperature setting, so there may be a question as to how the Platinum Touch/One chooses the correct level.

The menus in this section apply levels to ventilation, variable speed fans, curtains, and other related matters. The levels in the various menus are consistent with each other so that a level in one menu corresponds with that level in any other menu.

The rules that apply here are:

- **Rule 1:** If the temperature is at target (in the Happy Zone) stay at the current level.
- **Rule 2:** If the temperature moves outside the Happy Zone; have some patience.
- **Rule 3:** After the designated delay, increase or decrease levels appropriately.

You can find the 'patience' factors under [Exhaust and Tunnel Fans Help | Set Definitions](#). They are the increase level delay and decrease level delay parameters. The factory default values are 180 seconds for an increase and 60 seconds for a decrease.

The factory default values bias the Platinum Touch/One slightly toward warmer temperatures, as would be appropriate for young birds. The level increase delay is longer than the level decrease delay. You may wish to reverse these values by the time you have market age broilers, since they are more sensitive to heat stress than to cold.



Although many of the levels have 0.0 differential temperatures, certain levels should have differentials to account for wind chill on the birds. The first tunnel level accounts for wind chill by switching to the tunnel temperature instead of target temperature. Higher tunnel levels require an additional wind chill because of the increased airflow.

In addition, the last few levels before entering tunnel can form a transitional region. You may want to build differentials from target temperature just before the first tunnel level.

The controller obeys both the time delay rules and the differential temperature rules when changing levels. Tunnel exit has several additional rules, such as outside temperature restriction and the tunnel exit delay described under [Exhaust and Tunnel Fans Help | Set Definitions](#). In addition, there are Cool Down and change to Min Vent on reaching the Heat temperature features described in [Temperature Curve Help | Set Definitions](#)

## 6.5.2 EXHAUST AND TUNNEL FANS

The Precision Ventilation table provides up to 30 ventilation levels controlling both variable fans and relay-controlled fans. To program this table, start with the minimum ventilation used in the first level and increase ventilation gradually. A reasonable rule of thumb is to increase the airflow about 25% at each level. Increases in airflow up to 50% work satisfactorily with factory default settings.

Levels Of Ventilation													
Exhaust & Tunnel Fans				Vent & Curtain			Variable Speed Fans				Stir & Variable Stir Fans		
Level	Air Capacity	Diff.	Tunnel Level	Exhaust			Tunnel						
				E1	E2	E3	T1	T2	T3	T4	T5	T6	
1	0	0.0	<input type="checkbox"/>	X	X	X	X	X	X	X	X	X	X
2	0	0.0	<input type="checkbox"/>	X	X	X	X	X	X	X	X	X	X
3	0	0.0	<input type="checkbox"/>	X	X	X	X	X	X	X	X	X	X
4	0	0.0	<input type="checkbox"/>	X	X	X	X	X	X	X	X	X	X
5	87,000	0.0	<input type="checkbox"/>	●	●	X	X	X	X	X	X	X	X
6	87,000	0.0	<input type="checkbox"/>	●	X	●	X	X	X	X	X	X	X
7	72,500	0.0	<input type="checkbox"/>	X	X	X	X	●	X	X	X	X	X
8	158,050	0.0	<input type="checkbox"/>	●	●	●	●	X	X	X	X	X	X
9	145,000	0.0	<input type="checkbox"/>	X	X	X	X	●	X	●	X	X	X

### 1. Do one or both:

- In System > [Relay Outlet](#), define at least one relay as a Tunnel Fan or Exhaust Fan.
- In System > [Analog Output](#), define one function as Tunnel Fan.

### 2. In System > Levels of Ventilation > Exhaust & Tunnel Fans, Define:

- **Level:** Read-only showing the ventilation level.
- **ON:** Set ON time for fans for that ventilation level.
- **Air Capacity:** Displays the current exhaust fan or tunnel air flow for each ventilation level. If [Variable Speed Fan Levels](#) have been set, the speed percentage is taken into account.

- **Differential Temperature:** Triggers next level according to difference from target temperature (time delays remain in effect).
  - The first several levels normally have differential temperatures set to 0.
  - If the ventilation level is below tunnel, the differential temperature is relative to the Target temperature given in [Temperature Curve](#).
  - If the ventilation level is a tunnel level, the differential temperature is relative to the Tunnel temperature given in [Temperature Curve](#).
- **Tunnel Level:** This field shows if the minimum level switches to Tunnel Level.
- **Exhaust/Tunnel:** Define the exhaust or tunnel fans as Continuous, Cycle, and Rotate.

● **Continuous:** Works constantly without a break

● **Cycle:** Operates according to ON/OFF timer

○ **Rotate:** Operates according to ON/OFF timer; in each cycle a different fan operates



3. If required, click  and set the parameters.

### 6.5.2.1 Exhaust and Tunnel Fans Help | Set Definitions

Vent Levels - Settings			
Ventilation Levels			
Maximum Levels Of Ventilation	20	Fan Cycle Time (Sec., 0-Manual)	300
Increase Level Delay Time (Sec.)	60	Decrease Level Delay Time (Sec.)	60
First Tunnel Level	11	Maximum Fans, Switch To Tunnel	1
Tunnel Exit Delay (Min.)	10	Tunnel Exit - Diff. Below Tunnel	1.0
Tunnel Exit - Out Temperature Diff. Above Tunnel	5.0	Enable Wind Chill	<input type="radio"/> No
Wind Chill Limit	8.0	RH Effect	0.3

- **Define:**
  - **Maximum Levels of Ventilation:** Set the maximum number of levels.
  - **Fan Cycle Time (sec, 0-Manual):** If set to 0, set on and off times for each level manually. If you are using a fixed cycle time, such as 300 seconds, enter it here and enter only the **On** time at each level. Default: 0
  - **Increase Level Delay Time (sec):** Set length of time in seconds before transitioning to a higher level.
  - **Decrease Level Delay Time (sec):** Set length of time in seconds before transitioning to a lower level.
  - **First Tunnel Level:** Set the entry point to tunnel mode. Zero disables this parameter.
  - **Maximum Fans, Switch to Tunnel:** Set the maximum number of fans allowed to operate when entering tunnel mode.
  - **Tunnel Exit Delay (minutes):** Set length of time in minutes before exiting Tunnel mode. This time begins once all other parameters are satisfied.

- **Tunnel Exit – Diff Below Tunnel:** Set degree of difference below Tunnel temperature (set in [Temperature Curve](#)) to Exit Tunnel mode.
- **Tunnel Exit – Out Temperature Diff. Above Tunnel:** The outside temperature must read below this (Tunnel + Differential) to allow exiting from tunnel mode.
- **Wind Chill:** Refer to the following section.

### 6.5.2.2 Wind Chill

Platinum Touch/One can take into consideration the wind chill factor when making certain calculations related to the temperature. In effect, the wind chill factor acts as the temperature differential. When enabled, Platinum Touch/One determines the “calculated temperature (actual temperature – wind chill temperature) and uses this temperature:

- When calculating the Tunnel Mode level up/down algorithms
- When operating the Cool Pad (if enabled in System Variables; refer to Operate Cool Pad, page 40).

The Wind Chill factor influences controller operation from the 1st tunnel level.

*NOTE The actual temperature: 1) determines the entry and exit into Tunnel Mode 2) controls the fogger.*

**Define:**

- **Enable Wind Chill:** Enable this parameter to include the wind chill factor in ventilation calculations. Default = No.
- **Wind Chill Limit:** Maximum wind chill factor value. Default = 8° C.
- **RH Effect:** The decrease in temperature caused by an increase in relative humidity. Default is 0.26° C.

The Relative Humidity Effect parameter enables including the relative humidity (RH) in the wind chill factor calculations. A rise in relative humidity reduces the wind chill factor. How does it work?

- There is no effect below 40% relative humidity.
- The user determines the increase in temperature for every 5% increase in relative humidity.
  - The default increase is 0.26° C; meaning that between 40.1% - 45% relative humidity, the wind chill factor decreases by 0.26° C. Between 45.1% - 50%, the wind chill factor decreases by 0.52° C, twice the default level. Between 50.1% - 55%, the decrease is 0.78° C, three times the default level, and so on.
  - The user can set the temperature increase as required.
  - To disable this feature, enter '0'.

### 6.5.3 VENT & CURTAIN LEVELS

Set the curtain levels to correspond with the ventilation levels. The operating mode determines the curtain control procedure.

Levels Of Ventilation							
Exhaust & Tunnel Fans		Vent & Curtain		Variable Speed Fans		Stir & Variable Stir Fans	
Level	Tunnel Level	Vent	Tunnel		Curtain		
			Tunnel 1	Curtain 1	Curtain 2		
1	<input type="checkbox"/>	0	0	0	0	0	
2	<input type="checkbox"/>	0	0	20	0	0	
3	<input type="checkbox"/>	0	10	40	15	0	
4	<input type="checkbox"/>	0	50	80	80	0	
5	<input type="checkbox"/>	60	0	0	0	0	
6	<input type="checkbox"/>	60	0	0	0	0	

➤ Before setting the levels, define the opening mechanism (refer to [Vent & Curtain Levels](#)).

1. In System > Relay Layout, define at least one relay as Curtain Open, Tunnel Open, Vent Open, or Attic Open.

2. In System > Levels of Ventilation > Vent & Curtain Levels, define:







- **Level:** Ventilation level; read-only.
- **Tunnel Level:** Read only.
- **Tunnel/Curtain/Vent/Attic:** Set position for the tunnel curtain by level. If you have Static Pressure in Tunnel turned on ([Control | Static Pressure | Help | Set](#)), this becomes the minimum position for the tunnel inlet.

3. If required, configure each opening to work with a particular temperature sensor. Refer to [Temperature Definition](#).

4. If required, click  and set the parameters.

#### 6.5.3.1 Vent & Curtain Levels Help | Set Definitions Version

Users employing Version 7.18 and below, refer to Appendix E: Functions in Previous Versions.

Vent & Curtain Levels - Settings			
Curtains			
2nd Vent Operate From Day	-2 	2nd Vent Operate From Level	1 
3rd Vent Operate From Day	-2 	3rd Vent Operate From Level	1 
4th Vent Operate From Day	-2 	4th Vent Operate From Level	1 

## Curtains and Vents

- **Vent Operate from Day:** Define on which day vents 2, 3, or 4 begin to operate.
  - Vents must be defined in System > Relay Layout to operate.
  - To define Vents 2, 3, and 4:
    - Vent 1 must be operating.
  - Vents 2, 3, and 4 operate independently; however define lowered number vents before defining succeeding vents. For example, define Vent 2 before defining Vent 3.

### 6.5.4 VARIABLE SPEED FAN LEVELS

In the Variable Speed Fan Level table set the speed in percentages by level.

➡ This function requires an Analog Output card.

This card sends a low voltage control signal to a variable speed controller to run the variable speed fan. Several kinds of speed controllers are available, such as TRIAC Control, and Variable Frequency Three Phase drives.

Levels Of Ventilation					
Exhaust & Tunnel Fans		Vent & Curtain		Variable Speed Fans	
Level	Tunnel Level	Tunnel		Exhaust (%)	
		2	2	3	3
1	<input type="checkbox"/>	---	0	---	0
2	<input type="checkbox"/>	---	---	---	---
3	<input type="checkbox"/>	---	---	---	---
4	<input type="checkbox"/>	---	---	---	---

1. In System > [Analog Output](#), define at least one output as a variable speed fan.
2. In System > Level of Ventilation > [Variable Speed Fans](#), define the fans' working percentages.

### 6.5.5 STIR AND VARIABLE FAN LEVELS

Levels Of Ventilation					
Exhaust & Tunnel Fans		Vent & Curtain		Variable Speed Fans	Stir & Variable Stir Fans
Level	Tunnel Level	Variable Fan		Stir Fan	
		2	V1	-V2	-V2
1	<input type="checkbox"/>	0	X	---	X
2	<input type="checkbox"/>	0	X	---	X
3	<input type="checkbox"/>	0	X	---	X
4	<input type="checkbox"/>	0	X	---	X
5	<input type="checkbox"/>	0	X	---	X
6	<input type="checkbox"/>	0	X	---	X
7	<input type="checkbox"/>	0	X	---	X

1. Do one or both:
  - In System > Relay Layout, define at least one relay as a Stir Fan or
  - In System > [Analog Output](#) define one function as Variable Stir Fan.
2. In System > Levels of Ventilation > Stir and Variable Stir Fan Levels, Define:
  - **Ventilation Level:** Read only.
  - **Variable Fan:** Set variable speed fan operation in percentages.
  - **Stir Fan Number:** Control stir fans according to Continuous, Cycle On, Cycle Off (ventilation cycles are the same as previously set in Levels of Ventilation).

- Continuous:** Constantly works without a break.
- Cycle:** Operates according to ON/OFF timer.
- Rotate:** Operates according to ON/OFF timer; in each cycle a different fan operates.

*NOTE The Stir Fans operate according to the levels you program in this menu, and according to the programs you select in the [Stir Fan Program](#). The fan turns on if any program or level requests ON; all programs and levels must be OFF for the Stir Fan to be off.*

3. Map each stir fan to a temperature sensor (refer to [Temperature Definition](#)) (option).

In the Stir Fan Level table set the speed in percentage that you want the variable speed fan to work at (by levels). For each level, program the stir fans' cycle. Configure the actual speed in [Analog Output](#).

*NOTE The numbers shown in the screen under Variable Fan depend on how you defined the fans in System > Relay Layout and Analog Output.*

## 6.6 Stir Fan Program

This section contains five different programs that you can assign to each stir fan. Check the programs applying to each fan (further explained in [Stir Fan Program Help | Set Definitions](#)).

*NOTE If the same variable stir fan is selected for different programs, the program having the highest fan speed operates.*

Stir Fan Program					
Fan No.	Program				
	A	B	C	D	E
1	<input type="checkbox"/>	<input type="checkbox"/>	<input checked="" type="checkbox"/>	<input type="checkbox"/>	<input type="checkbox"/>
2~	<input type="checkbox"/>	<input type="checkbox"/>	<input checked="" type="checkbox"/>	<input type="checkbox"/>	<input type="checkbox"/>
3	<input type="checkbox"/>	<input type="checkbox"/>	<input checked="" type="checkbox"/>	<input type="checkbox"/>	<input type="checkbox"/>
4	<input type="checkbox"/>	<input checked="" type="checkbox"/>	<input checked="" type="checkbox"/>	<input type="checkbox"/>	<input type="checkbox"/>
5	<input type="checkbox"/>	<input type="checkbox"/>	<input type="checkbox"/>	<input type="checkbox"/>	<input type="checkbox"/>
6	<input type="checkbox"/>	<input type="checkbox"/>	<input type="checkbox"/>	<input type="checkbox"/>	<input type="checkbox"/>

1. In System > Relay Layout, define the required number of relays.
2. Go to System > Stir Fan Program.
3. Define which fans run under which program:

- A (heaters): This program corrects temperature variations lengthwise in the building. Insert diff and sensor numbers.
- B (for min vent): This program helps mixing minimum ventilation air for buildings having stir fans to mix the air coming in with warm inside air.
- C, D & E (sensors diff temperature): These options create three stir fan groups which operate according to sensor differentials.



4. If required, click  and set the parameters.

## 6.6.1 STIR FAN PROGRAM HELP | SET DEFINITIONS

- Program A (for Heaters)
- Program B (for Min Vent)
- Program C, D, E (Sensors Diff Temp or Independent)

### 6.6.1.1 Program A (for Heaters)

Stir Fan Program - Settings			
Program A (For Heaters)			
Diff. Below Target To Operate	0.6 	Cycle On Time (Sec.)	0 
Cycle Off Time (Sec.)	0 	From Level	0 
To Level	0 	From Time (hh:mm)	00:00 
To Time (hh:mm)	00:00 	Stop During Fan Operation	<input type="radio"/> No

- **Define:**
  - **Diff Below Target to Operate:** Set the degree of difference below the target temperature for stir fans to operate.
  - **Cycle On time (sec):** Define the length of time in seconds you would like the stir fan to operate during the cycle.
  - **Cycle Off time (sec):** Define the length of time in seconds you would like the stir fan to be off during the cycle.
  - **From/To Level:** Limit the program to operate between the levels defined.
  - **From/To Time:** Define the time frame for the program to operate (24-hour format).
  - **Stop During Fan Operation:** Select **YES** run the heaters when the fans are operating.

### 6.6.1.2 Program B (for Min Vent)

Stir Fan Program - Settings			
Program B (For Min Ventilation)			
Operate After End Of Cycle	<input checked="" type="radio"/> On	Delay For Operation (Sec.) (+/-)	0
Time For Operation (Sec.)	0	From Level	0
To Level	0	From Time (hh:mm)	00:00
To Time (hh:mm)	00:00		

- **Define:**
  - **Operate after End of Cycle:** Set when stir fan begins operating. It can be at the end of the ON cycle or the OFF cycle set in the [Levels of Ventilation](#).
  - **Delay for Operation (sec):** Define length of time in seconds from the end or start of cycle you chose in Operate after end of cycle above, for the stir fans to operate.
  - **Time for Operation (sec):** Define length of time in seconds for the stir fans to operate.
  - **From/To Level:** Limit the program to operate between the levels defined.
  - **From/To Time:** Define the time frame for the program to operate (24-hour format).

### 6.6.1.3 Program C, D, E (Sensors Diff Temp or Independent)

Stir Fan Program - Settings			
Program C (Sensors Diff. Temp.)			
Temperature Diff. To Operate	1.1	Diff. Between Sensor Number	0
Diff. Between Sensor Number	0	Cycle On Time (Sec.)	0
Cycle Off Time (Sec.)	0	From Level	0
To Level	0	From Time (hh:mm)	00:00
To Time (hh:mm)	00:00	Stop During Fan Operation	<input type="radio"/> No
Minimum Variable Stir Fan Speed	30	Maximum Variable Stir Fan Speed	100

- **Define:**
  - **Temp Diff to Operate:** Set the degree of difference between sensors for stir fans to begin operating.

**NOTE** If this parameter is set to 0 (zero), the variable stir fan runs independently of the sensors.

- **Diff between Sensor Number:** Select a sensor to define one temperature reading.
- **Diff between Sensor Number:** Select a second sensor to define a temperature reading from a different area.
- **Cycle On time (sec):** Define the length of time in seconds you would like the stir fan to operate during the cycle.



- **Cycle Off time (sec):** Define the length of time in seconds you would like the stir fan to be off during the cycle.
- **From/To Level:** Limit the program to operate between the levels defined.
- **From/To Time:** Define the time frame for the program to operate (24-hour format).
- **Stop During Fan Operation:** Select **YES** run the heaters when the fans are operating.
- **Variable Stir Fan:** Select the stir fan to be used
- **Min/Max Var. Stir Fan Speed:** Enter the minimum and maximum speed (in percentage).

## 6.7 Relay Layout

Use this screen to define the devices connected to the controller.

Relay Layout				
Relay No.	Device	No.	N.C.	
Card 1 Main Slot 1				
1	Radiant Low	1	<input type="checkbox"/>	
2	Tunnel Fan	1	<input type="checkbox"/>	
3	Exhaust Fan	1	<input type="checkbox"/>	
4	Stir Fan	1	<input type="checkbox"/>	
5	Vent Open	1	<input type="checkbox"/>	
6	Vent Close	1	<input type="checkbox"/>	
7	Tunnel Open	1	<input type="checkbox"/>	
8	Tunnel Close	1	<input type="checkbox"/>	
9	Light	1	<input type="checkbox"/>	
10	Water	1	<input type="checkbox"/>	
Card 2 Main Slot 2				

1. Go to System > Relay Layout.

2. Select the required relay from the drop-down list (refer to [Output Function List](#)).

**NOTE** If required, you can set the relay number manually.

- Enter relays according to equipment installation (I/O technician list) using up/down arrow keys.



3. If required, click  and set the parameters.

- If you have installed Current Sense relays, Platinum Touch/One defines them automatically. Current sense relays transmit to the user's PC the amount of the current being passed to the relay and send alarms when the current is too low or too high. In addition, you can view the daily electricity consumption in History. Refer to [Current Sense Relay Calibration](#) for calibration instructions.

## 6.7.1 OUTPUT FUNCTION LIST

	Relay Name	Quantity Supported
1.	Heaters	16
2.	Radiant Heaters Low	16
3.	Radiant Heaters High	16
4.	Radiant Heaters Ignite	16
5.	Tunnel Fan	30
6.	Exhaust Fan	20
7.	Stir Fan	15
8.	Cooling	4
9.	Cooling Pad	4 (Version 7.20 and below) 6 (Version 7.21)
10.	Fogger	4
11.	Vent (Inlet) Open	2 (Version 7.18 and below) 4 (Version 7.19)
12.	Vent (Inlet) Close	2 (Version 7.18 and below) 4 (Version 7.19)
13.	Tunnel Open	4 (Version 7.18 and below) 6 (Version 7.19)
14.	Tunnel Close	4 (Version 7.18 and below) 6 (Version 7.19)
15.	Curtain Open	4
16.	Curtain Close	4
17.	Attic Open	1
18.	Attic Close	1
19.	Vent Speed	1
20.	Light	4
21.	Water	4
22.	Feeder	4
23.	Auger	4
24.	Extra System	4
25.	Alarm (N.C.)	1
26.	Fail Safe (N.C.)	1
27.	Feeder Win Open	1
28.	Feeder Win Close	1
29.	Feeder Line Up	1
30.	Feeder Line Down	1
31.	Drink Line Up	1

	Relay Name	Quantity Supported
32.	Drink Line Down	1
33.	Water Main	1
34.	Water Bypass	1
35.	Water Line	10
36.	WOD	4
37.	AS Relay	8
38.	AS Analog Output	8

## 6.7.2 RELAY LAYOUT SETTINGS

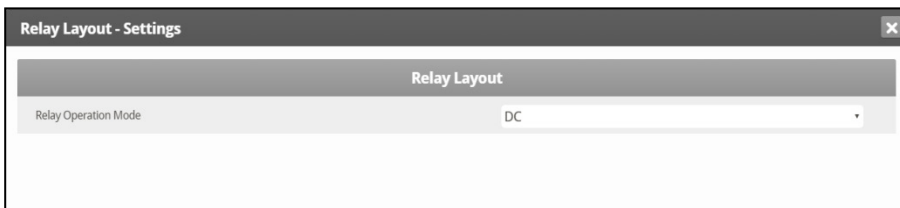

- Define relay operation mode: DC or AC.

*NOTE AC mode produces less heat in the controller box.*



## 6.8 Sensors

- [Analog Sensors](#)
- [Digital Sensors](#)

### 6.8.1 ANALOG SENSORS

- ➡ Install analog input cards.

This screen enables the user to define the analog sensors. The Platinum Touch/One regards temperature, humidity, and CO2 sensors and circuit breaker as analog sensors. These sensors measure a continuous range rather than just on or off.

**Sensors**  

**Analog** **Digital**

Output No.	Function	Sensor No.
Card 1 Main Slot 2		
1	Temperature	1
2	Temperature	2
3	Temperature	3
4	Temperature	4
5	Temperature	5
6	Temperature	6
7	Humidity Sensor In	1
8	Humidity Sensor In	2
9	CO2 Sensor	1



1. Go to *System > Sensors > Analog*.
2. On each input, define the sensor as required using the drop-down list.

*NOTE If sensor numbers duplicate, the sensors average.*

## 6.8.2 DIGITAL SENSORS

 Install digital input cards.

This screen enables configuring the installed digital sensors. These sensors monitor both water and feed consumption if the building is equipped accordingly. Digital inputs include on/off and pulsing inputs such as auxiliary alarms, pulsing water meters and feed.

**Sensors**  

**Analog** **Digital**

Output No.	Function	Sensor No.
Card 1 Main Slot 1		
1	Water Meter	1
2	Feed Count	1
3	Low Water S.Pressure	1
4	Hopper	1
5	Intermediate	1
6	Feed Scale Interlock	1
7	None	0
8	None	0
9	None	0

1. Go to *System > Sensors > Digital*.
2. On each input, define the sensor as required using the drop-down list.
  - Platinum Touch/One automatically numbers the sensors according to their function.

- You cannot define more than the permitted number of any particular sensor. For example, you can define one function as Cool Pad Water Meter, not two.

## 6.9 Analog Output

Analog output can be used to control:

- Variable speed fans
- Variable stir fans
- Vents
- Curtains
- Light dimmers
- Variable heaters
- Tunnels

➡ Install analog output cards.

Analog Outputs Installation				
Output No.	Function	Output Function	Min V.Out	Max V.Out
↳ Card 1 Main Slot 4				
1	Tunnel Fan	2	0.0	10.0
2	Exhaust Fan	2	0.0	10.0
3	Stir Fan	2	0.0	10.0
4	Vent	2	0.0	10.0
5	Tunnel Curtain	2	0.0	10.0
6	Light Dimmer	1	0.0	10.0
7	Variable Heat	1	0.0	10.0
8	Water On Demand	1	0.0	10.0
9	Exhaust Fan	3	0.0	10.0
10	Light Dimmer	2	0.0	10.0

1. Go to *System* > *Analog Output*.
2. Enter the devices wired to each input (setup according to technician).

**NOTE** The above is an example of an analog output configuration.

- [Light Dimmer, Variable Speed Fan, Variable Heater, Variable Stir Fan Control](#)
- [Vent, Tunnel, and Curtain Analog Output Control](#)

### 6.9.1 LIGHT DIMMER, VARIABLE SPEED FAN, VARIABLE HEATER, VARIABLE STIR FAN CONTROL

- To configure the light dimmers, refer to [Light](#), page 63.
- To configure the variable speed fans, refer to [Stir Fan Program](#), page 122.
- To configure the variable heaters, refer to [Temperature Curve Help | Set Definitions](#), page 18.

### 6.9.2 VENT, TUNNEL, AND CURTAIN ANALOG OUTPUT CONTROL

Vents, tunnels, and curtains can be controlled via:

- A physical relay (device is physically wired to a relay) OR

- An analog output (device is wired to an actuator that is connected to the Platinum Touch/One analog output card)

Assigning an analog output to a vent, tunnel, or curtain enables them to open and close **automatically**, according to the analog output.

1. Define an output as vent, tunnel, or curtain.
2. Record the output number.
3. Enter the minimum and maximum voltage outputs according to the actuators' requirements.

However, to enable opening and closing manually, a relay must be mapped to the analog output.

*NOTE The following steps are optional.*

4. Go to *System > Relay Output*.
5. Define a relay as **Analog Out**.
6. Place the cursor in the number column and enter the recorded output number.
7. Repeat for each relay.

*NOTE If a vent is operating over analog output, there potentiometer feed-back support is disabled.*

## 6.10 Temperature Definition

This screen assigns specific temperature sensors for various brood setups and for heater zones. Moreover, assigning sensors to particular devices is possible. Note that if the sensors selection remains blank, the default value is assigned.

Choose 1 to 18 temperature sensors for each item listed. The house, brooding and tunnel sensors cause the current average to apply to devices when no specific sensor is assigned to them. The current average substitutes for either failed or missing sensors.

➡ Sensors 10 – 18 require installing a second analog card.

Temperature Definition						
Function	Sensors					
	1	2	3	4	5	6
Full House	<input checked="" type="checkbox"/>	<input checked="" type="checkbox"/>	<input checked="" type="checkbox"/>	<input checked="" type="checkbox"/>	<input checked="" type="checkbox"/>	<input checked="" type="checkbox"/>
Tunnel	<input checked="" type="checkbox"/>	<input type="checkbox"/>	<input type="checkbox"/>	<input type="checkbox"/>	<input type="checkbox"/>	<input type="checkbox"/>
Attic	<input type="checkbox"/>	<input checked="" type="checkbox"/>	<input type="checkbox"/>	<input type="checkbox"/>	<input type="checkbox"/>	<input type="checkbox"/>
Outside	<input type="checkbox"/>	<input type="checkbox"/>	<input type="checkbox"/>	<input type="checkbox"/>	<input type="checkbox"/>	<input type="checkbox"/>
Heat 1	<input type="checkbox"/>	<input type="checkbox"/>	<input type="checkbox"/>	<input type="checkbox"/>	<input type="checkbox"/>	<input type="checkbox"/>
Radiant 1	<input type="checkbox"/>	<input type="checkbox"/>	<input type="checkbox"/>	<input type="checkbox"/>	<input type="checkbox"/>	<input type="checkbox"/>
Stir Fan 1	<input checked="" type="checkbox"/>	<input type="checkbox"/>	<input type="checkbox"/>	<input type="checkbox"/>	<input type="checkbox"/>	<input type="checkbox"/>
~ Stir Fan 2	<input type="checkbox"/>	<input type="checkbox"/>	<input checked="" type="checkbox"/>	<input type="checkbox"/>	<input type="checkbox"/>	<input type="checkbox"/>
Cool Pad 1	<input checked="" type="checkbox"/>	<input checked="" type="checkbox"/>	<input type="checkbox"/>	<input type="checkbox"/>	<input type="checkbox"/>	<input type="checkbox"/>
Cool Pad 2	<input type="checkbox"/>	<input type="checkbox"/>	<input type="checkbox"/>	<input type="checkbox"/>	<input type="checkbox"/>	<input type="checkbox"/>
Cool Pad 3	<input type="checkbox"/>	<input type="checkbox"/>	<input type="checkbox"/>	<input type="checkbox"/>	<input type="checkbox"/>	<input type="checkbox"/>

- Refer to [Temperature Curve](#).
- Assign Temperature Sensors as required in System > Temp Definition. Devices that do not accept temperature sensors, such as Exhaust Fans, Tunnel Fans, Feed and Light do not appear.

*NOTE If you are using two (2) input analog cards, the screen displays Temp. Sensor(s) 1-18 (refer to above screen capture).*

*NOTE When an attic sensor is not installed, the attic vent is disabled.*

*NOTE The ~ symbol designates an analog output device.*

Note that Exhaust Fans and Tunnel Fans do not appear because the Ventilation Levels defined in System > Levels of Ventilation control their operation. Stir Fans appear even though the System > Levels of Ventilation > Stir Fan Levels apply to them because they simultaneously operate according to System > Stir Fan Programs where specific sensor assignments are required in Program B and recommended in Program C.

## 6.11 Vent/Curt Setup

➡ In System > Setup, define Static Pressure unit as None.

Use this screen to define the ventilation opening and closing mechanism. You can use one of three methods:

- Using Time to Calibrate
- Using a Potentiometer to Calibrate
- Using Wind Direction
- Stop Fans
- Vent/Curtain Help | Set Definitions

If you map a curtain or vent to a potentiometer, the Platinum Touch/One controller uses that method (and not time).

*NOTE After defining the method used, define the opening levels in [Vent & Curtain Levels](#).*

### 6.11.1 USING TIME TO CALIBRATE

Enter the number of seconds to open and close from limit to limit for each of the Vents and Curtains in your installation. Platinum Touch/One then calculates the percentage of open and closed time and adjusts the static pressure methods accordingly.

Vent/Curt Setup						
Curtain	Pot.	Potentiometer	Open	Close	Wind Direction	Stop Fans
Vent 1	<input type="radio"/> None	0	60	60	0	<input type="radio"/> No
~ Vent 2	<input type="radio"/> None	0	60	60	0	<input type="radio"/> No
Tunnel 1	<input type="radio"/> None	0	60	60	0	<input type="radio"/> No
~ Tunnel 2	<input type="radio"/> None	0	60	60	0	<input type="radio"/> No
Curtain 1	<input type="radio"/> None	0	60	60	0	<input type="radio"/> No

- Set full open/full close time (in seconds) for Curtains, Tunnel, 1<sup>st</sup> & 2<sup>nd</sup> Vent, and Attic Vent.

NOTE Default is set at 60 seconds.

NOTE Munters recommends setting the [Help parameters](#) to maintain an accurate position.

NOTE The ~ symbol designates an analog output device.

## 6.11.2 USING A POTENTIOMETER TO CALIBRATE

Each curtain/vent/inlet can be mapped to a potentiometer. Potentiometer feedback enables precise positioning on each specific device opening value. In this screen, assign a potentiometer to a device.

Curtain	Pot.	Potentiometer	Open	Close	Wind Direction	Stop Fans
Vent 1	<input type="radio"/> None	0	60	60	0	<input type="radio"/> No
~ Vent 2	<input checked="" type="radio"/> Pot.	1	60	60	0	<input type="radio"/> No
Tunnel 1	<input type="radio"/> None	0	60	60	0	<input type="radio"/> No
~ Tunnel 2	<input type="radio"/> None	0	60	60	0	<input type="radio"/> No
Curtain 1	<input type="radio"/> None	0	60	60	0	<input type="radio"/> No

1. In *System > Sensors*, define analog sensors as potentiometers.
2. In *System > Vent/Curt Setup*, designate a device as Pot.
3. Map the curtain/vent/tunnel/inlet to a potentiometer in this screen.

The number of devices that you can map equals the number of potentiometer relays.

4. Calibrate the potentiometer ([Ventilation Potentiometer Calibration](#)).

NOTE After calibrating the potentiometer, the times shown here change to reflect the calibration process.

In the event that the potentiometer fails (meaning there is no value change during the curtains/vents/inlets movement):

- Platinum Touch/One transmits an alarm message.
- The specific curtain/vent/inlet mapped to the failed potentiometer starts operating by time calculation, using the times calculated by the calibration process. However, if required you can enter new opening and closing times.
- **Version 7.19:** If a curtain or vent (controlled by a potentiometer) should open or close but does not move the controller sends an alarm.
  - The controller sends an alarm if the curtain/vent moves less than 1% of the required movement within 30 seconds (this number cannot be changed).
  - Controllers only send alarms when the Potentiometer Alarm is enabled (page 89).
  - No alarm is sent if the curtain/vent is:
    - Within 95 - 100% and opening
    - With 5 - 0 % and closing



### 6.11.3 USING WIND DIRECTION

This parameter is enabled only when Natural Ventilation is enabled. Refer to [Preliminary Steps](#), page 42 for details.

*NOTE The Proximity to Edge % parameter takes priority over the Close Below This Temp parameter. Meaning, if the outside temperature mandates closing the curtain, the curtains will still open if they are within the proximity defined in the Proximity to Edge parameter.*

### 6.11.4 STOP FANS

Stop Fan parameter enables turning off fans if a specific curtain is moving below its minimum position. This function prevents the curtain from sticking if the static pressure is too high and curtains have not yet moved into a position which will cause the pressure to drop.

Vent/Curt Setup						
Curtain	Pot.	Potentiometer	Open	Close	Wind Direction	Stop Fans
Vent 1	<input type="radio"/> None	0	60	60	0	<input type="radio"/> No
~ Vent 2	<input checked="" type="radio"/> Pot.	1	60	60	0	<input type="radio"/> No
Tunnel 1	<input type="radio"/> None	0	60	60	0	<input type="radio"/> No
~ Tunnel 2	<input type="radio"/> None	0	60	60	0	<input type="radio"/> No
Curtain 1	<input type="radio"/> None	0	60	60	0	<input type="radio"/> No

*NOTE Default is NO.*

*NOTE The ~ symbol designates an analog output device.*

### 6.11.5 VENT/CURTAIN HELP | SET DEFINITIONS

These parameters enable maintaining an accurate curtain position when using time to calibrate.

**Vent/Curt Calibration**

**Vent & Curtain Calibration**

From Time	00:00	To Time	00:00
Number Of Steps	0	Power Up Vents Calibration	<input type="radio"/> No
Proximity To Edge (%)	10	Close Below This Temp. (Out)	0.0

**Position Accuracy**

Precision Around Target %	0
---------------------------	---

- Define:

#### VENT/CURTAIN CALIBRATION

- **From/To Time:** Time period in which calibration is enabled.
- **Number of Steps:** Number of steps for automatic calibration: Set calibration point for curtain after desired amount of curtain opening/closing (steps).

During calibration, if the curtain is open more than 50% it opens to 100%, calibrates, and returns to the previous position. If the curtain is open less than 50% it closes to 0%, calibrates, and returns to the previous position. Default: 99.

- **Power Vents Calibration:** This parameter enables automatic calibration of air inlets when recovering from a power outage. In many installations the backup system, such as Munters' RBU-27, may have opened the air sources. When the Platinum takes over control again, the air inlets are incorrectly positioned. The calibration at power up feature synchronizes the actual position and the controller.
- **Proximity to Edge %:** Curtain will open or close based on this proximity to the edge. For example, when set to 10%, the curtain closes when the opening is less than 10% and opens completely when the opening is greater than 90%.
- **Close Below This Temp. (out):** Curtains close when the outside temperature reaches this point.

➡ This parameter requires defining a temperature sensor as an outside sensor (refer to Temperature Definition).

*NOTE The Proximity to Edge % parameter takes priority over the Close Below This Temp parameter. Meaning, if the outside temperature mandates closing the curtain, the curtains will still open if they are within the proximity defined in the Proximity to Edge parameter.*

### Precision Accuracy

- **Precision Around Target:** Define the band around the opening target. When the vent or curtain reaches this range, it remains in place and no longer attempts to reach the exact opening position.

## 6.12 House Dimensions

The screen allows the user to set its' house dimensions. Set it according to actual house size. These dimensions are used for calculating the wind chill factor (the chilling effect of the wind that can significantly lower the temperature).

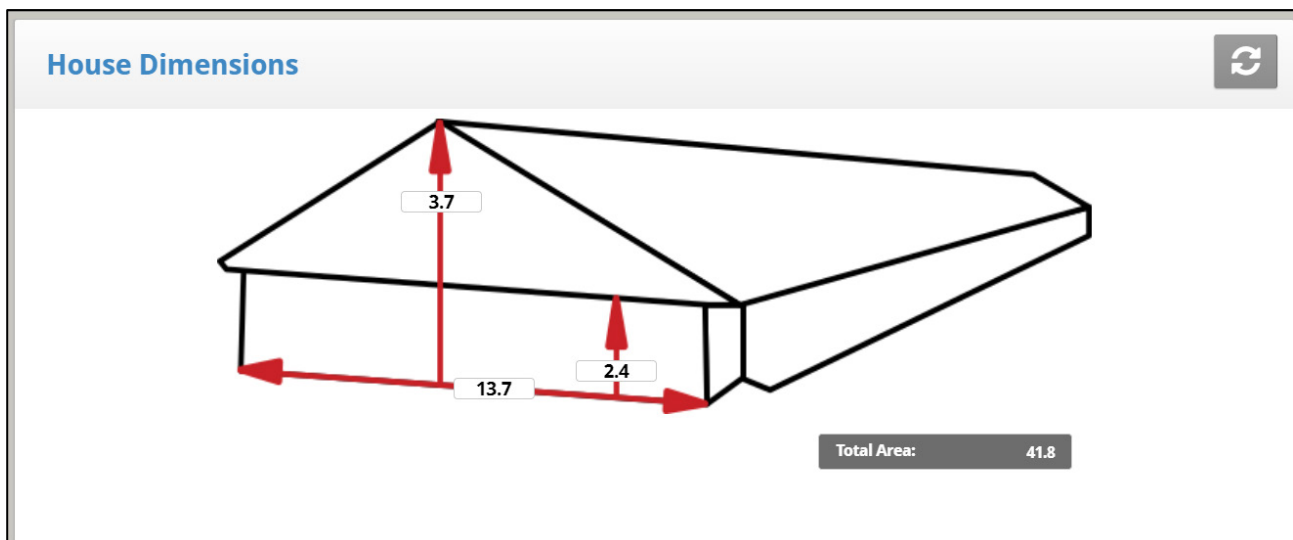

- Define height, width, and length of house (controller calculates total area).

- To set the dimensions in metric or non-metric units, go to System > Setup and scroll down to Length Unit.

*NOTE This information enables the calculation of the Wind Chill factor displayed in Hot Screen Key = 2 (Tunnel mode ONLY).*

## 6.13 Fan Air Capacity

This screen enables defining the fans' air capacity. Insert fan air capacity for both the exhaust and tunnel fans.

Fan Air Capacity	
Fan	M3/H
Tunnel Fan 1	37,500
Tunnel Fan 2	75,000
Tunnel Fan 3	112,500
Tunnel Fan 4	75,000
Tunnel Fan 5	112,500
Tunnel Fan 6	112,500
Exhaust Fan 1	54,000
Exhaust Fan 2	36,000

1. In System > Relay Layout and/or System > Analog Output, define the fans.
2. In System > Setup, define the fan air capacity unit.
3. In System > Fan Air Capacity, define air capacity (default setting shown above).

*NOTE This information enables the display of air capacity for each level in the Levels of Ventilation table.*

## 6.14 Setting up a Bird Weight Curve - Summary

In Versions 7.22 or above, setting up a bird curve means defining the following items in the Scale Menu:

- [Scale Card](#): Define at least one scale.
- Gender Separated Weighing: Define if weight curves are gender separated.
  - [Non-gender separated](#) weighing provides an automatic curve, a user-customized curve, or industrial standard curves.
  - [Gender separated weighing](#) provides automatic curve, an automatic turkey curve, or a user-customized curve.
- [Bird Scale Setting](#): Define the curve type (Auto, Custom, or Factory Curve)
- [Bird Weight](#): Define the reference weight or curve data points (day and weight).

## 6.15 Non-Gender Based Weighing

- Scale Layout
- Bird Scale Setting
- Bird Weight

## 6.15.1 SCALE LAYOUT

Use Scale Layout to define the scales or silos connected to the controller.

- Scale Layout Main Screen
- Scale Layout | Set Definitions

### 6.15.1.1 Scale Layout Main Screen

*NOTE A scale card must be installed in the controller or an RSU-2 unit must be connected to the controller for these screens to appear.*

Use this screen to define the card functions. Platinum Touch/One supports the RSU-2 and two types of scale cards:

- Two channel scale cards: Supports bird scales only.
- Six channel scale cards: Supports bird, silo, and feed scales (Breeder Mode does not support feed scales). The controller can support up to ten weighing channels.
- Refer to the installation manual regarding Munters' recommendations regarding these options.

Channel	Function	No.
Scale Card 1 Main Slot 4		
1	Scale	1
2	Silo	1
3	Feed Scale	1
4	Scale	2
5	Silo	2
6	None	0

### 6.15.1.2 Scale Layout | Set Definitions

Scale Layout - Settings

Scale Layout

Separate Male Female

- If male and female birds live in the same house, select No.
- If you want separate male/female weight curves, refer to Gender Based Weighing, page 139.

## 6.15.2 BIRD SCALE SETTING

*NOTE This screen relates to Version 7.19 and above.*

➔ Define at least one scale, silo, or feed scale in Scale Layout.

This section describes the Bird Scale Settings for Broiler mode. Refer to Breeder and Layer Mode appendices to view the function for those modes.

- Bird Scale Setting Screen
- Bird Scale Setting | Set Definitions

### 6.15.2.1 Bird Scale Setting Screen

Go to System > Scale Settings > Bird Scale and elect the algorithm used to calculate the bird curve that appears in Bird Weight. There are three options:

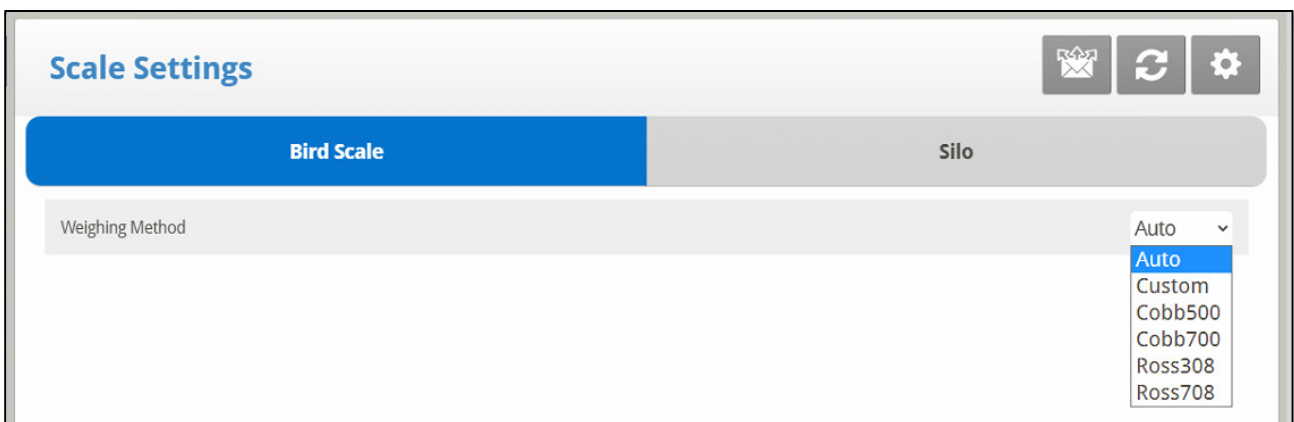

- **Auto:** Set the first target weight. The controller then automatically calculates each day's reference weight.
- **Custom:** The controller provides a weight vs growth day curve, which the user can edit as required.
- **Factory Default Curve:** The controller loads an industry standard bird curve. This curve cannot be edited.

### 6.15.2.2 Bird Scale Setting | Set Definitions

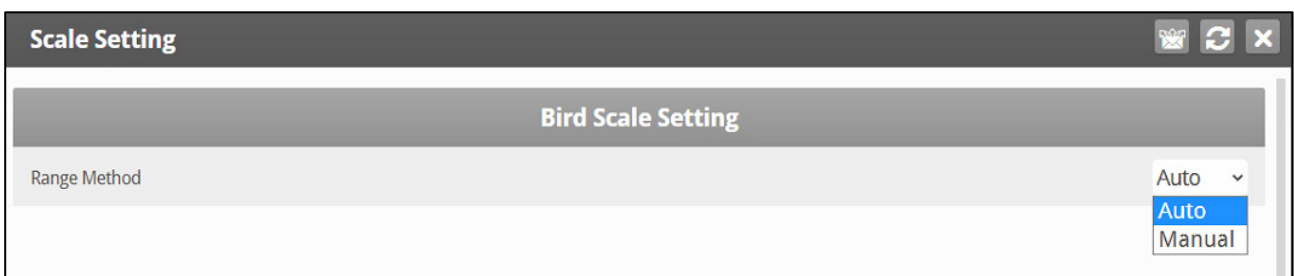

This parameter defines the range of weights that are recorded. Bird weights that are outside of the band are discarded.

- If you select Auto, Platinum Touch automatically calculates the band of acceptable weights.
- If you select Manual, define the upper and lower ranges.

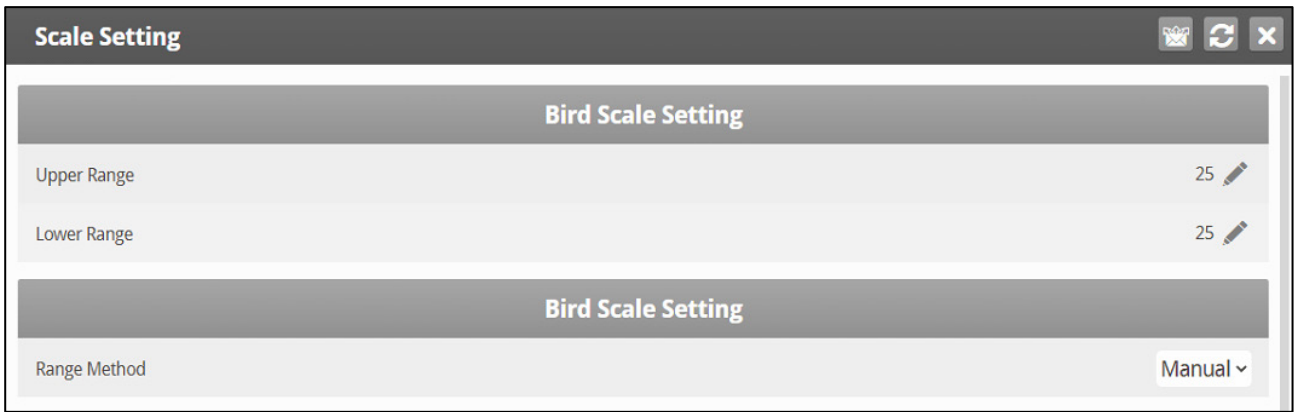

### 6.15.3 BIRD WEIGHT

- Bird Weight Main Screen
- Bird Weight Help | Set Definitions

#### 6.15.3.1 Bird Weight Main Screen

In this screen, edit the bird curve selected in Bird Scale Settings.

- Go to System > Bird Curve.
  - If you selected Auto in Bird Scale, edit the weight as required. The weight is automatically adjusted.



- If you selected Custom in Bird Scale, edit the curve as required.

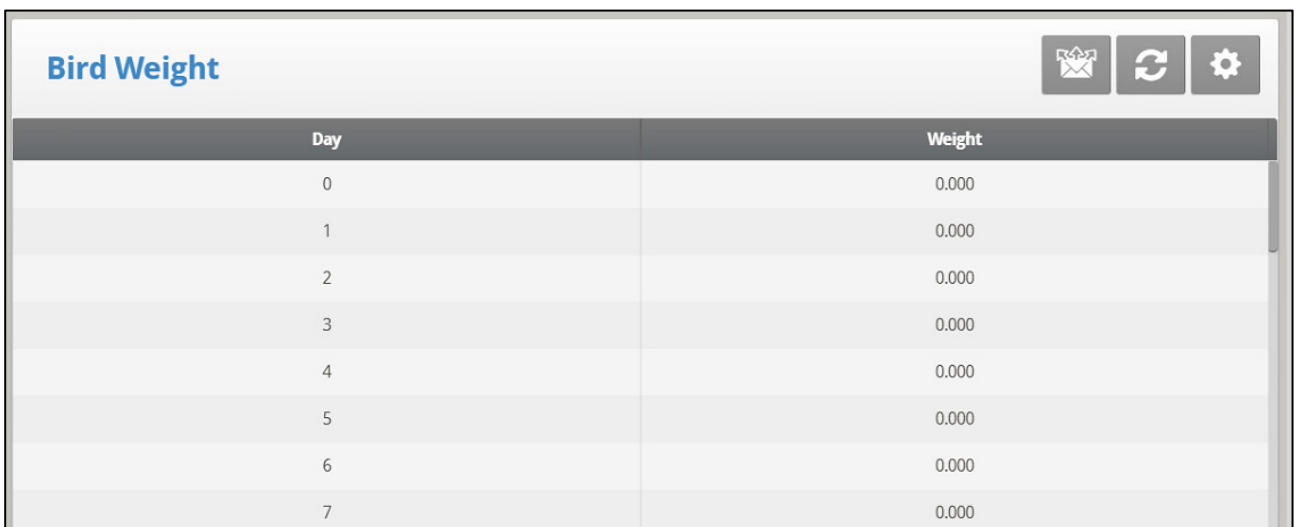

- If you selected an industrial standard, the curve is read only.

Bird Weight	
Day	Weight
0	0.042
1	0.052
2	0.065
3	0.079
4	0.097
5	0.118
6	0.143
7	0.171

### 6.15.3.2 Bird Weight Help | Set Definitions

*NOTE* This option is only available if you choose Custom or an industrial standard curve.

- Bird curve offset: Enter the factor used to adjust the weight curve. This amount is added to the Reference weight field. Range: 0.0 – 10.0 Kg/Lb.

### 6.16 Gender Based Weighing

Version 7.22 provides an option for gender-based weighing.

1. Go to System > Scale Layout > Help.

2. Select Yes.
3. Go to System > Scale Settings > Bird Scale > Help. Select Auto or Manual.

This parameter defines which measured bird weights are used in calculating the actual curve. Bird weights that are outside of the band are discarded.

- If you select Auto, Platinum Touch calculates the band of acceptable weights.
- If you select Manual, define the female/male upper and lower weight ranges.

The screenshot shows a window titled "Scale Setting" with a dark header bar containing icons for a crown, refresh, and close. The main content is divided into two sections: "FEMALE" and "MALE".

FEMALE	
Upper Range	10
Lower Range	15
MALE	
Upper Range	15
Lower Range	10

4. Go to System > Scale Settings > Bird Scale.



The screenshot shows a window titled "Scale Settings" with a light header bar containing icons for a crown, refresh, and settings. Below the header is a tabbed interface with "Bird Scale" selected (highlighted in blue) and "Silo" as an alternative tab. The main area contains a table for configuring scales.

Weight Method	
Scale 1	Auto  (dropdown menu open showing: Auto, Curve, Auto Turkey, Female Weight)
Scale 2	Female Weight
Scale 3	Female Weight
Scale 4	Female Weight

- Define the weighing method: Auto, Curve, Auto Turkey. Curve includes a user-defined curve option and industrial standard curve options.
- Define each scale as female or male.
- Version 7.24:
  - Define each scale as male, female, or male and female.
  - Define the time period during which weight data is collected





### Scale Settings

Bird Scale

Silo



Weight Method	Auto
Scale 1	Male & Female
Scale 2	<div style="border: 1px solid #ccc; padding: 2px;">             Female Weight              Male Weight  <b>Male &amp; Female</b>              Male &amp; Female           </div>
Scale 3	Male & Female
Scale 4	Male & Female
From Time (hh:mm)	00:00 
To Time (hh:mm)	00:00 

- Auto or Auto Turkey Curve
- Customized/Industrial Standard Curves

#### 6.16.1 AUTO OR AUTO TURKEY CURVE

- Go to System > Bird Curve.
  - If you selected Auto or Auto Turkey in Bird Scale, edit the weights as required. The weight is automatically adjusted.



### Bird Weight

Description	Value
Current Female Weight	0.042
Current Male Weight	0.042

- If you selected Curve in Bird Scale, edit the curve as required.

### Bird Weight

Day	Female	Male
0	0.000	0.000
7	0.000	0.000
14	0.000	0.000
21	0.000	0.000
28	0.000	0.000
35	0.000	0.000

## 6.16.2 CUSTOMIZED/INDUSTRIAL STANDARD CURVES

1. Go to System > Bird Weight > Help.

**Bird Weight**

**FEMALE**

Bird Curve Offset: 0.000

Select Curve: Custom

**MALE**

Bird Curve Offset:

Select Curve:

- Custom
- Cobb500FFDarkOut
- Cobb500FFDarkOpenSided
- Cobb500FFDarkSlowDark
- Cobb500FFDarkSlowOpen
- Cobb700
- Ross708F
- NicholasTurkeyF

2. For female and male, enter the factor used to adjust the weight curve. This amount is added to the Reference weight field. Range: 0.0 – 10.0 Kg/Lb.
3. For female and male, select the required curve from the drop-down list.
4. Go to System > Bird Weight.

**Bird Weight**

Day	Female	Male
0	0.045	0.042
7	0.160	0.150
14	0.280	0.340
21	0.400	0.525
28	0.520	0.690
35	0.620	0.830
42	0.720	0.960
49	0.820	1.090

- If you selected Custom, you can edit the curve.
- If you selected an industrial standard curve, the curve is read-only.

## 6.17 Silo Setting

These settings help you monitor your silo through weighing. There are two events that take place, emptying (feeding) and filling (loading).

*NOTE Silos must be defined in Scale Layout for the following parameters to be functional.*

- Go to System > Scale Settings > Silo.

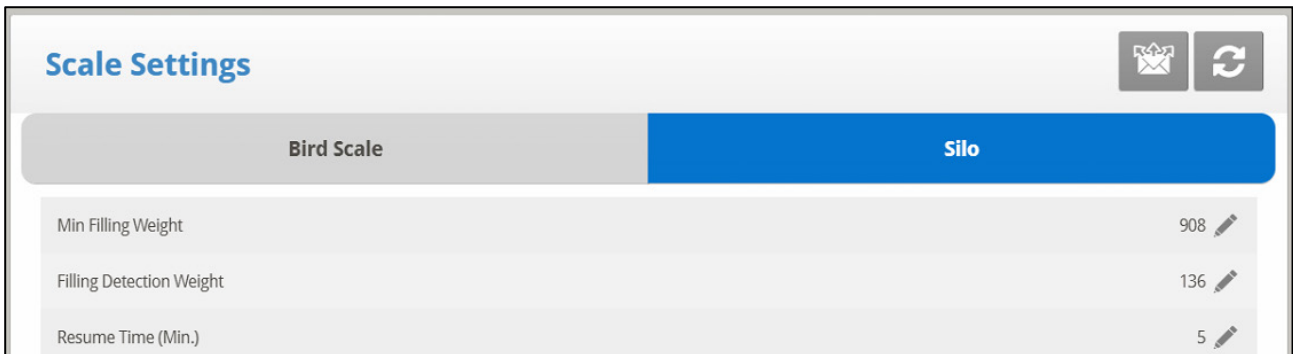

Scale Settings	
Bird Scale	Silo
Min Filling Weight	908
Filling Detection Weight	136
Resume Time (Min.)	5

- **Minimum Filling Weight** (Default: 2000 Kg): Define weight required to be filled during loading to be recorded in **History – Feed Consumption History**; **History –Table of Events**.
- **Filling Detection Weight** (Default: 300 Kg): Define the weight you want your controller to detect a filling to stop augers.
- **Resume Time (minute)** (Default: 5 min.): Once loading is completed, define the time you want your controller to count down for the augers to resume normal operation.

The following is a typical scenario:

A loading truck will come to fill the bin or silo. Define the **Filling Detection Weight** to stop the augers from operating during a loading event (Default: 300 Kg). Next, a **Minimum Filling Weight** needs to be defined to have the filling event recorded in the **Feed Consumption History** (Default: 2000 Kg). Once the loading of the feed is finished, the timer begins to count down for the augers to resume normal operation (**Resume Time**, Default: 5 minutes) and for the filling event to be recorded as completed.

## 6.18 Communication

Communication		
Baud Rate	9600	▼
House No.	1	

- Define the communication setup:
  - **Baud rate:** This parameter is a measure of the communication speed for local or remote communications to a PC. The default is 9600 represents a data rate of approximately 1000 characters per second. If the connection fails at this speed, try a lower speed.

**CAUTION** *The baud rate used must be the same in all controllers, computers, and other devices.*

- **House number:** Each controller on a network must have a unique number (1 – 64) so Munters' communication software can distinguish individual controllers.

**CAUTION** *Platinum Touch/One can support one expansion device only.*

## 6.19 System Update

Refer to Software Upgrade, page 14.

**NOTE** *This item only appears on the Touch unit itself. It does not appear when accessing the Touch via the web.*

# 7 Appendix A: Output Data

Table 1: Sensor Readings

Sensor	Definition
Temp	Displayed with the specific sensor number
Out T.	Outside temperature
Press.	Pressure
Hum. In	Inside humidity
Hum. Out	Outside humidity
Weight	Average weight
Weights	Number of weights
Breaker	Circuit breaker

Table 2: Output List (Active)

Output	Definition
Alarm	Can be either active or not. Note that this always appears last.
Heat	Indicates operating heat number
Heat. Hi	Indicates operating heat high number
Tun. Fan	Indicates operating tunnel fan number
Exh. Fan	Indicates operating exhaust fan number
Stir	Indicates operating stir fan number
Cool P.	Indicates operating cool pad number
Fogger	Indicates operating fogger number
Inlet	Mentions opening percentage
Tunnel	Mentions opening percentage
Curt.	Mentions opening percentage
Ext. Sys	Indicates operating external system number
Light	Note that these mention output percentage
Water	Indicates operating water number
Feed	Indicates operating feed number
Auger	Indicates operating auger number
Rad. Lo	Indicates operating radiant heat low number
Rad. Hi	Indicates operating radiant heat high number

Table 3: Status Readings

Status	Definition
Time	Specific time
Day	Growth day

Status	Definition
Set	Target temperature
Offset	Temperature Curve HELP   SET parameter
House mode	Control Mode HELP  SET parameter
Level	Level number
Tunnel, Natural, Min. Vent	The controller's state
Fan Off	How long the cycle ends its' operation
Fan On	How long the cycle begins its' operation
Curve off	Occurs when located in low curve temperature or when the Control Mode HELP   SET 'Temperature Curve' parameter is set to OFF.
Hum. Treat	Indicates when treatment occurs
Cool flush	Indicates when flush occurs
Nip. Flush	Indicates when flush occurs

Table 4: Table of Events

Event	Event Explanation
Power Off	Appears when power is off
Power On	Appears when power is on
Cold Start	Appears when cold start is done
Change level to vent	Changes according to a specific stage
Backup set reminder	HELP   SET: 'Set Temp. Change remainder (diff)' parameter
Alarm on	Appears when the alarm is on
Change in setting	
Change in switches	Relay switch setting changed
New flock	Appears when new flock is updated
Reset alarm	Appears when reset alarm is done
System message #	For Munters' technicians only
Alarm card fail	Appears when the alarm card fails
Digital card fail	Appears when the digital card fails
Memory restore	Appears when the system does restore cause by noises
Minimum ventilation	Appears when minimum ventilation occurs
Natural ventilation	Appears when entering natural ventilation
Tunnel ventilation	Appears when entering tunnel ventilation
Alarm test	Appears when alarm test completes
Precision Mode	Switch to Precision Mode
Standard Mode	Switch to Standard Mode
Changed growth day	Appears when changing the growth day occurs
MinV L.P Alarm Dis.	Appears when minimum low pressure alarm is disabled
MinV L.P Alarm Ena	Appears when minimum low pressure alarm is enabled
Tun. L.P Alarm Dis.	Appears when tunnel low pressure alarm is disabled

Event	Event Explanation
Tun L.P Alarm Ena.	Appears when tunnel low pressure alarm is enabled
Visitor Log in	Appears when the visitor logs in with his password
User #1-5 log in	Appears when the user logs in with his password
Owner log in	Appears when the owner logs in with his password
Change Visitor pass	Appears when the visitor changed his password.
Change User #1-5 pass	Appears when the user changed his password
Change Owner pass	Appears when the owner changed his password
Data read from plug	Appears when data is read from plug
System recover	Appears when the system tries to recover itself, in cases such as noises
System lock	Appears when either using the correct password, or when using hot key '9,' or automatically after 5 minutes
Empty house mode	Appears when setting at a specific time
<b>Version 7.23</b>	
Ref Weight Change	Appears when Curve Offset is manually changed in Scale>Bird Weight>Settings. Change can be a different curve, gender, or offset.
Factor Change	Appears when Factor is manually changed in Scale>Calibration
Scale or Silo Calibration	Appears when silos/scales are manually calibrated in Scale>Calibration

# 8 Appendix B: Keyboard Functions

There are several functions which must be configured using the keyboard found on the inside door. This section details those functions.

- Service Menu
- Management Menu
- Scale

## 8.1 Service Menu

The Service Menu items calibrate various Platinum Touch/One functions.

- Temperature Calibration
- Humidity Calibration
- CO2 Sensor Calibration
- Static Pressure Calibration
- Light Sensor Calibration
- Feed Calibration
- Water Calibration
- Ventilation Potentiometer Calibration
- Save Settings
- Load Settings
- Current Sense Relay Calibration

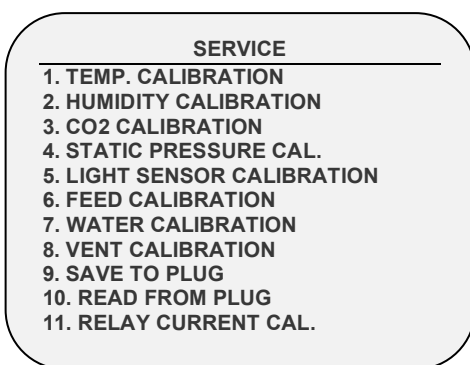

Figure 12: Layers Service Menu

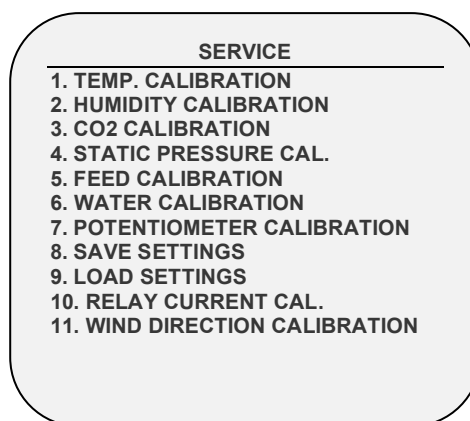

Figure 13: Broiler Service Menu



## 8.1.1 TEMPERATURE CALIBRATION

The temperature sensors are typically accurate to approximately 0.5° F within the range of temperatures for poultry production. Calibrate them in this menu by adding/subtracting a constant correction factor to each sensor. Adjust the sensor of your choice with the left/right arrow keys.

TEMPERATURE CALIBRATION		
Sensor	Temp°	Factor
1	78.2	1.6
2	86.4	0.9
3	83.0	-1.5
4	86.2	0.8
5	85.2	-1.6
6	84.2	0.0

Calibrating against infrared or in air temperature sensors generally results in less accuracy than the basic sensors have without calibration.

**CAUTION** Only calibrate the sensors if you have reason to believe that they are producing inaccurate results.

To calibrate the sensor:

1. Obtain an accurate reference sensor and a pail of water at the approximate required temperature.
2. Stir the reference sensor together with the Platinum Touch/One sensor vigorously in the bucket of water. Keep your hands off the sensor itself, so that it responds accurately to the water temperature. Stirring is necessary to preclude stratification within the bucket of water.
3. Call out the accurate reading to a second person standing at the Platinum Touch/One. Walkie-talkie radios may be a good idea.
4. The individual at the controller should double-check that you are calibrating the correct sensor. You might warm/cool the sensor temporarily to see which sensor changes temperature appropriately.
5. Once you determine the correct temperature and allow approximately one minute for stabilization in the water, adjust the sensor reading at the controller.
6. Offset the factor using the left/right arrow keys.

## 8.1.2 HUMIDITY CALIBRATION

To calibrate the humidity level, obtain a suitable humidity test kit and use the procedures described there. They are commonly available via the Internet.

**CAUTION** Only calibrate the sensors if you have reason to believe that they are producing inaccurate results.

HUMIDITY CALIBRATION		
Sensor	Humidity°	Factor
In-1	58.9	2.3
Out	N/A	---

Press Left/Right Arrows to Calibrate

- Adjust the Platinum Touch/One reading as needed using the left/right arrow keys.

### 8.1.3 CO2 SENSOR CALIBRATION

To calibrate the CO2 level, obtain a suitable test kit and use the procedures described in the kit. Ensure that the house is well ventilated, either naturally or using fans.

**CAUTION** Only calibrate the sensors if you have reason to believe that they are producing inaccurate results.

CO2 SENSOR CALIBRATION	
	Value
PPM at 4 mA/1 VDC	26
PPM at 20 mA/5 VDC	3000
Factor (PPM)	22

CO2 (ppm):  
482

CO2 SENSOR CALIBRATION	
CO2 - 1	
PPM at 4 mA/1 VDC	26
PPM at 20 mA/5 VDC	3000
Factor (PPM)	22
CO2 - 2	
PPM at 4 mA/1 VDC	26
PPM at 20 mA/5 VDC	3000
Factor (PPM)	22

CO2 -1 (ppm): 1243  
CO2 -2 (ppm): 1218

Figure 14: CO2 Calibration, Version 7.19 and below

Figure 15: CO2 Calibration, Version 7.20 (if two sensors are defined in Analog Sensors)

- Ppm at 4 mA / 1 VDC: Parts per million for 4 mA or 1 VDC
- Ppm at 20 mA / 5 VDC: Parts per million for 20 mA or 5 VDC
- Factor (ppm): (-/+ ) ppm shift from the current reading
- CO2 (ppm): Current CO2 readings
- Adjust the Platinum Touch/One reading as needed using the left/right arrow keys.

### 8.1.4 STATIC PRESSURE CALIBRATION

The Static Pressure should be 0 when there is no ventilation and the house is closed. When the controller A/D counts is 100, this means that there is zero (0) static pressure.

**CAUTION** The Static Pressure sensor is factory calibrated. Only calibrate the sensor if you have reason to believe that they are producing inaccurate results.

**NOTE** Run Platinum Touch for a few hours so that the temperature in the box becomes stable and only then calibrate.

**CAUTION** DO NOT blow the air into the hose to see if the pressure changes! The sensor is sensitive and blowing air can cause irreparable damage.

To calibrate the Static Pressure Sensor:

1. Disconnect the air hoses.
2. Go to *Service > Static Pressure Cal.*
3. If the A/D count is 100 +/- 30 (70 to 130), press Enter.
4. If the A/D count is less than 70 or greater than 130:
  - a. Check for blocked air hoses or wind interference.
  - b. Adjust the zero-pressure reading to approximately 100 by turning the calibration screw.
  - c. When the A/D count is within the permitted range, press Enter.

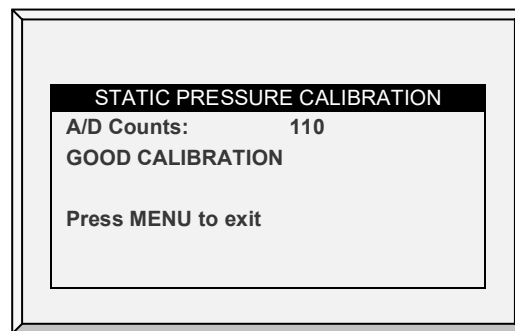
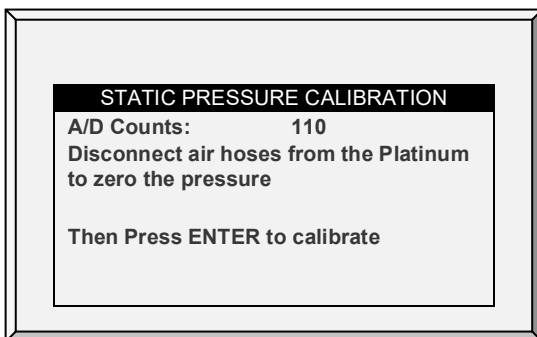

The static pressure sensor is located inside the controller in the upper left-hand corner to the left of the power supply.

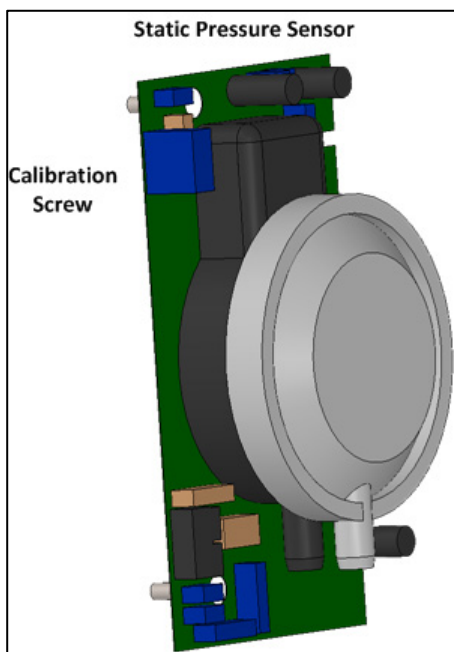

### 8.1.5 LIGHT SENSOR CALIBRATION

*NOTE Broilers/Layers mode supports this feature.*

Installing a light sensor enables turning off the lights when there is sufficient outside light.

To calibrate the light sensor:

1. Go to *Install > Analog Sensors*.
2. Define one sensor as a light sensor.
3. Go to *Management > Light*.
4. Press **Help**, highlight **Set**, and press **Enter**.
5. Scroll down to **Light Sensor Active** and set to **Yes**.
6. Place the sensor in the required location.
7. Go to *Service > Light Sensor Calibration*.
8. When the outside light is bright enough, press **Enter**.

### 8.1.6 FEED CALIBRATION

Platinum Touch/One can use silo scales or less expensive digital monitoring devices to keep track of your feed. This menu calibrates the digital monitoring devices.

1. Select the feed counting method. Your digital monitoring device may generate a dry contact pulse for each quantity of feed, or it may simply indicate that the feed is running.
2. Enter the quantity of feed per pulse in case you use a dry contact pulse. Otherwise, enter the amount of feed delivered per minute of auger operation.
3. Select one of the following:
  - **Pulse: Weight per pulse**
  - **Time: Weight per minute**
  - **Current Sense: Motor run time when the auger contains feed**
4. Enter quantity (weight per minute or per pulse).

FEED CALIBRATION				
Feed	1	2	3	4
Method	TIME	TIME	TIME	TIME
Factor	2.203	2.203	2.203	2.203

Method Pulse: Weight per Pulse  
Method Time: Weight per Minute  
Method Current: Weight per Minute

### 8.1.7 WATER CALIBRATION

Platinum Touch/One supports up to four dry contact pulse output water meters. Enter the quantity of water per pulse for your water meters.

WATER CALIBRATION			
Water 1	-	Water Per Pulse	0.100
Water 2	-	Water Per Pulse	0.100
Water 4	-	Water Per Pulse	0.100
Water 4	-	Water Per Pulse	0.100
Cool Pad	-	Water Per Pulse	2.203
Fogger	-	Water Per Pulse	2.203

### 8.1.8 VENTILATION POTENTIOMETER CALIBRATION

Use this screen to calibrate the ventilation potentiometer control. Potentiometer calibration is required before ventilation can be controlled via a potentiometer.

POTENTIOMETER CALIBRATION				
Pot	Device	Close	Current	Open
1	Vent 1	152	0	1000
2	Vent 2	152	0	1000

➡ Before calibrating the potentiometers:

- Disable the static pressure unit in *Install > Setup*.
- Define at least one relay as vent/inlet/tunnel in *Install > Relay Outlet*.
- Define at least one analog sensor as a potentiometer in *Install > Analog Sensor*.

1. Select a potentiometer number.

2. Press Enter.

- The device relay closes and then opens. As this takes place, the numbers in the Close, Current, and Open columns change. After a few minutes, the process completes and a "Good Calibration" message appears.

*NOTE After potentiometer calibration, the times displayed in the Vent/Curtain Setup screen change.*

### 8.1.9 SAVE SETTINGS

*NOTE Verify that the SD card is in the "Unlocked" position (see the following illustration). The card must be in the Unlocked position to enable software upgrades.*

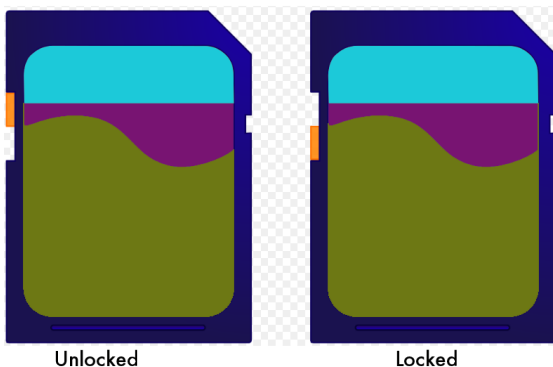

This menu enables the user to save the program settings to an SD card and transport them to another controller.

*NOTE If both a data plug and SD card are inserted, the data plug takes priority and that option appears on the screen.*

- Verify that the SD card is in place.
- The SD card must have at least 20K of free space.

To save settings:

1. Go to *Service > Save Settings*.
2. In the screen that appears, select YES and press Enter.
3. Select the required settings and press Enter.
4. Wait for the settings to download.

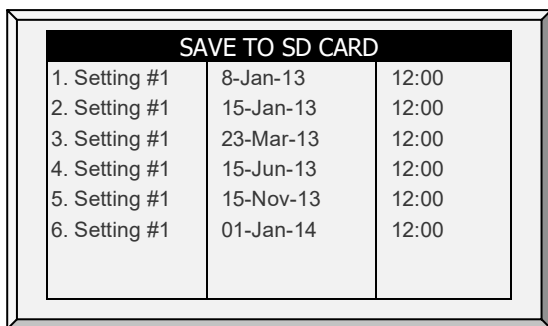

SAVE TO SD CARD		
1. Setting #1	8-Jan-13	12:00
2. Setting #1	15-Jan-13	12:00
3. Setting #1	23-Mar-13	12:00
4. Setting #1	15-Jun-13	12:00
5. Setting #1	15-Nov-13	12:00
6. Setting #1	01-Jan-14	12:00

### 8.1.10 LOAD SETTINGS

This menu enables the user to load settings saved on an SD card into a controller.

- Verify that the SD card is in place.
- The SD card must have at least 20K of free space.

To load settings:

1. Go to *Service > Load Settings*.
2. In the screen that appears, select YES and press Enter.
3. Select the required settings and press Enter.
4. Wait for the settings to upload.

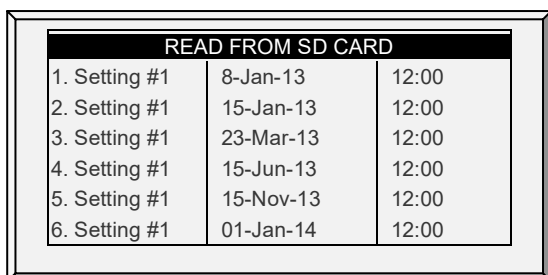

READ FROM SD CARD		
1. Setting #1	8-Jan-13	12:00
2. Setting #1	15-Jan-13	12:00
3. Setting #1	23-Mar-13	12:00
4. Setting #1	15-Jun-13	12:00
5. Setting #1	15-Nov-13	12:00
6. Setting #1	01-Jan-14	12:00

### 8.1.11 LOAD SETTINGS REPORT

*NOTE* Version 7.19 and above supports this function.

When uploading settings to a controller, Platinum Touch/One lists which tables (if any) will not be transferred. Compatibility issues might arise in cases when transferring settings between controllers using different software versions or having different configurations. By listing which tables will not transfer, the user knows which tables must be defined manually.

1. Go to Service > Load Settings.
2. In the screen that appears, select YES and press Enter.
3. Select the required settings and press Enter.
4. If there are any incompatible tables, a list of the pathways appears.

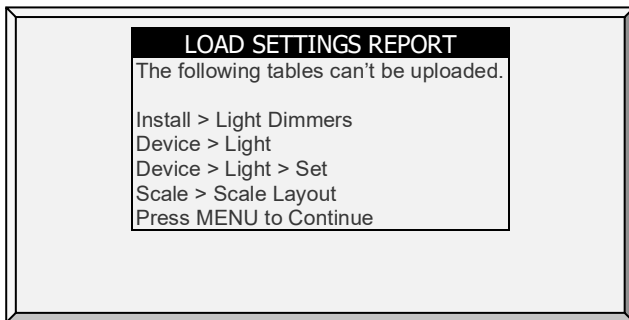

5. Press Menu. The following message appears:

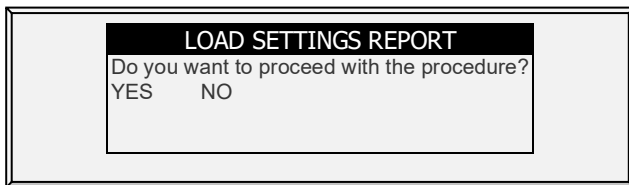

6. To proceed, select YES.
  - After loading the settings and resetting the controller, a record of incompatible tables can be viewed in Table of Events (page 110). Note that pathway is shown using a number to indicate the menu.

TABLE OF EVENTS			
	Event	Day	Time
20	Tunnel Ventilation	2	1:15:50
21	Minimum Ventilation	2	1:30:43
22	8. Light Dimmers	2	4:14:44
23	2. Light	2	4:14:44
24	2. Light / Set	2	4:14:44
25	4. Scale Layout	2	4:14:44
26	Data Read From Plug	2	4:14:44

### 8.1.12 CURRENT SENSE RELAY CALIBRATION

*NOTE* The Current Sense relays support single phase electricity only.

This menu calibrates the amount of current that passes through Current Sense relays. Calibration enables configuring the minimum and maximum permissible currents.

To calibrate the current sense relay:

1. Define the relay.
2. Select *Service > Relay Current Cal.*

RELAY CURRENT CALIBRATION			
Relay	Function	Measure	Current
			ON
31	Heat 6	Start	0.0
32	Heat 7	Start	0.0
33	Heat 8	Start	0.0
34	Exh. Fan 5	Start	0.0
35	Exh. Fan 6	Start	0.0

**Warning!!!**  
 The selected equipment will be turned ON now for current reading adjustment WAIT till operation completion for 15 sec  
 Verify that the relay switch is AUTO

3. Select a relay and click Enter.

*NOTE Set the relay to Auto.*

4. Repeat for each current sense relay.

RELAY CURRENT CALIBRATION			
Relay	Function	Measure	Current
			ON
31	Heat 6	Done	0.2
32	Heat 7	Done	0.2
33	Heat 8	Done	0.2
34	Exh. Fan 5	Done	3.8
35	Exh. Fan 6	Done	4.3

**Warning!!!**  
 The selected equipment will be turned ON now for current reading adjustment WAIT till operation completion for 15 sec  
 Verify that the relay switch is AUTO

5. To set the minimum and maximum voltages, alarms and 110/220 voltage, refer to Relay Current, page 158.

### 8.1.13 WIND DIRECTION CALIBRATION

Use this screen to calibrate a wind direction sensor.

- Define an analog sensor as wind direction.

WIND DIRECTION CALIBRATION		
	Direction	Calibration
Wind Direction	6	14.50



## 8.1.14 WOD CALIBRATION

- WOD Screen
- WOD Calibration Help | Set Definitions

### 8.1.14.1 WOD Screen

➡ Define an analog sensor as WOD.

WATER ON DEMAND CALIBRATION		
	Volt	Pressure - PSI
WOD 1st Calib.	2.50	14.50
WOD 2nd Calib.	7.50	43.50

**READ ME**

Enter output voltage for first point.  
Enter water meter measure pressure.  
Repeat this for the second point.

1. In *Installation* > *Setup*, set the Length Unit.
  - Metric = Bar
  - Non-Metric = PSI
2. In *Service* > *WOD Calibration*:
  - a. Enter the first voltage and check pressure data points.
  - b. Repeat for second data points.
3. Set the Help Definitions (optional)

### 8.1.14.2 WOD Calibration Help | Set Definitions

This parameter reduces the water pressure by a user-defined factor.

SYSTEM PARAMETERS	
<b>WATER ON DEMAND</b>	
Pressure Reducer Factor	50.00

1. In *Install* > *Setup*, define the Pressure unit.
2. In *Service* > *WOD Calibration* > *Help*, define the reduction factor. Water pressure is reduced by 1/50 (bar or PSI). The factor is accurate to two decimal points.

## 8.1.15 AMMONIA CALIBRATION

➡ Define an analog sensor as ammonia sensor.

To calibrate the ammonia level, obtain a suitable test kit and use the procedures described in the kit. Ensure that the house is well ventilated, either naturally or using fans.

➡ Only calibrate the sensor if you have reason to believe that they are producing inaccurate results.

AMMONIA CALIBRATION	
PPM at 0VDC	0
PPM at 5VDC	100
Factor (ppm)	0
AMMONIA (ppm) 15	

- Define the following:
  - Ppm at 0 VDC: Parts per million at 0 VDC
  - Ppm at 5 VDC: Parts per million at 5 VDC
  - Factor (ppm): (-/+ ) ppm shift from the current reading. Correct the sensor reading by editing this factor. The controller saves this data.
  - Ammonia (ppm): Current ammonia reading
- Adjust the Controller reading as needed using the left/right arrow keys.
- Refer to Ammonia Treatment.

## 8.2 Management Menu: Relay Current

*NOTE The Relay Current feature supports single phase electricity only.*

This menu configures the relay current sense parameters. You can configure:

- the minimum and maximum amperage flowing to the relays
- the relay current alarm
- voltage type

*NOTE Configuring the amperage is not required. The Platinum Touch/One controller automatically configures default settings.*

RELAY CURRENT SETTING						
Rly.	Function	Min	Nom	Max	Alr	Vlt
31	Heat 6	2.7	3.8	5.0	NO	110
32	Heat 7	2.7	3.8	5.0	NO	110
33	Heat 8	3.0	3.8	5.6	NO	110
34	Exh. Fan 5	2.7	4.3	5.0	NO	110
35	Exh. Fan 6	2.3	3.8	5.0	NO	110
36	Tun. Fan 1	3.0	4.3	5.6	NO	110
37	Tun. Fan 2	0.0	0.0	0.0	NO	110
38	Tun. Fan 3	0.0	0.0	0.0	NO	110

*NOTE Calibrate the relay before configuring these parameters. Refer to Current Sense Relay Calibration. Relays that are not calibrated (or if the relay is not a Current Sense relay) do not display amperage readings (see relays 37 and 38 in the above figure).*

To configure the relay current:

1. Using the arrow buttons, select a minimum or maximum amperage setting.
2. Configure the parameter as required.

*NOTE The minimum amperage must be greater than the default minimum and the maximum amperage must be less than the default maximum. For example, relay 35's amperage must be more than 2.3 and less than 5.0 amps.*

*The Nom amperage is the parameter set when [calibrating the relay](#).*

3. Configure the alarm:

- No: Alarms are not sent in the event of low or high current
- Yes: Alarms are sent in the event of low or high current
- No at zero: The controller sends an alarm if the current is low or high, but not if power is cut off entirely.

4. Configure the voltage: Select 110 or 220 volts.

*NOTE All relays' minimum/maximum current settings per equipment type must be within 30% (±) of the nominal value. However, the augers minimum can go down to 0.0 amperes.*

## 8.3 Scale Menu

- Test
- Scale and Silo Calibration

### 8.3.1 TEST

This section is a real-time table to show the statuses of all scales connected to the controller. Make sure that all statuses are O.K. If any of them show a different status, the scale is not installed properly. Unused positions can also show O.K.

1. In *Scale > Scale Layout* (refer to page ), select the required scale types.
2. In *Scale > Test*, test the scales as required.

TEST			
Ch	A/D	Weight	Status
Silo 1	2024	0.222	O.K.
Silo 2	2010	0.240	O.K.
Feed Scale 1	2024	0.200	O.K.
Silo 3	2011	0.240	O.K.
Scale 1	2000	0.222	O.K.
Scale 2	2024	0.222	O.K.

### 8.3.2 SCALE AND SILO CALIBRATION

This menu calibrates the scales and silos connected to the controller.

1. In *Scale > Scale Layout* the required scale types.
2. In *Scale > Calibration*, calibrate the scales.

**CAUTION** Do not use scales while calibrating.

#### 8.3.2.1 Scale Calibration

1. Follow instructions on the bottom section of the screen.
2. Wait until the progress bar displayed shows 100%.
3. Place a known weight on the scale and enter its weight.
4. Wait until the calibration progress bar reaches 100%.

### 5. Ensure “Good Calibration.”

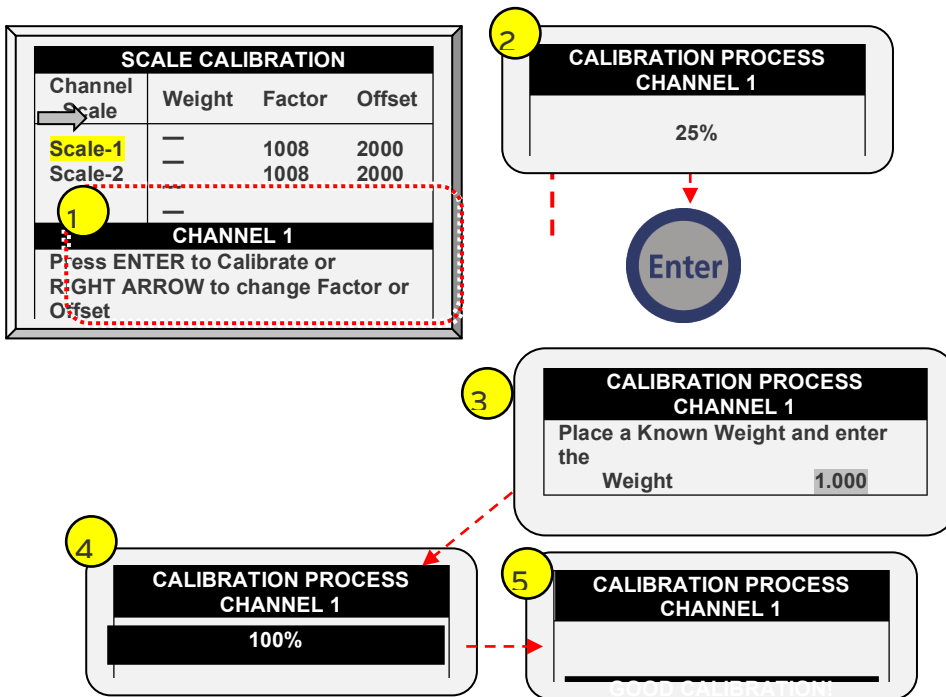

### 8.3.2.2 Silo Calibration

1. Follow instructions on the bottom section of the screens.
2. Wait until the progress bar displayed shows 100%.
3. Place a known weight or start filling the silo.
4. Wait until the calibration progress bar reaches 100%.
5. Ensure “Good Calibration.”

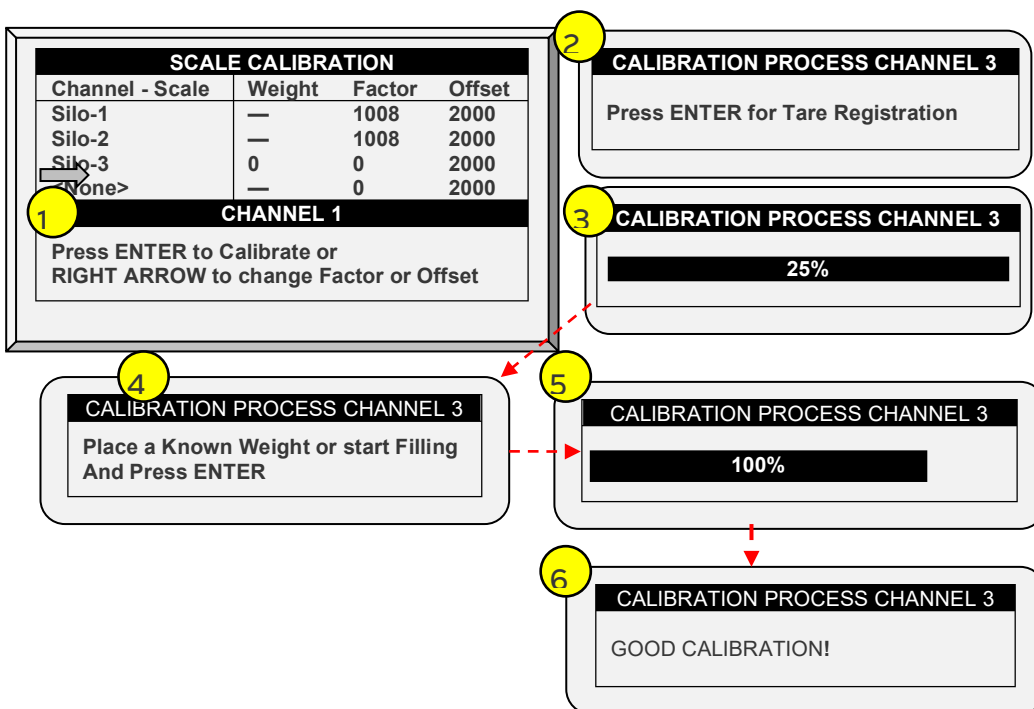

## 8.4 Test Menu

- Alarm
- Analog Sensors
- Digital Sensors
- Analog Output
- Static Pressure
- Communication

### 8.4.1 ALARM

Press Enter to toggle the Alarm Relay.

- ON means alarms are functioning.
- OFF means alarms are not functioning.

Note that the alarm relay is powered for the 'NO ALARM' condition to provide automatic Power Fail Alarm in case of power failure to the controller. That is, the Normally Open side is closed during NO ALARM.

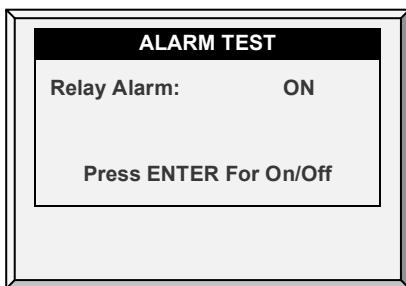

### 8.4.2 ANALOG SENSORS

Observe the converter readings for analog sensors with this menu.

The screenshot shows a terminal window with a black header bar containing the text "ANALOG IN TEST" in white. Below the header is a table with the following data:

In.	Sensor	A/Value
CARD 1		
1	Temp. Sensor 1	470 64.0
2	Temp. Sensor 2	426 87.2
3	Temp. Sensor 3	470 85.6
4	Temp. Sensor 4	426 82.0
5	Temp. Sensor 5	470 87.0
6	<None>	
7	<None>	
8	<None>	
9	<None>	
10	<None>	

At the bottom of the table, the text "Box 1 Card 1 Slot 3 Channel 1" is displayed.

The readings can vary from 0 to 1023. The values displayed in the 'Value' column indicate that the analog sensor is operating or not according to the following:

- If a very large value is shown (such as a four-digit number) or a small value is shown (such as a one-digit number): sensor is not connected.

- If the unit displays a 3-digit number, usually beginning with the digit '4': sensor is operating.

### 8.4.3 DIGITAL SENSORS

This screen displays the digital sensors states.

DIGITAL IN TEST			
In.	Sensor	State	Counter
<b>CARD 1</b>			
1	Water Meter 1	1	0
2	Water Meter 2	0	0
3	Fogger Water Meter	0	0
4	AUX. Alarm	0	0
5	AUX. Alarm	0	0
6	Low Water Pressure	0	0
7	Wind Speed	0	0
8	<None>	0	0
Box 1	Card 1	Slot 3	Channel 1

A '1' implies a shorted input, a '0' an open input. The digital sensors operate with dry contact inputs such as the Arad Water Meter, or micro-switches.

You can apply a short/open input to each channel; the response is then displayed.

*NOTE The water meter quantities appear on the main screen or on Hot Screen 0.*

### 8.4.4 ANALOG OUTPUT

This screen tests light dimmers, variable speed fans, and variable heaters.

1. Scroll to the required output.
2. Enter the test voltage and verify that the device is operating.

ANALOG OUT TEST		
Output.	Sensor	0 – 10v
<b>CARD 1</b>		
1	Light Dimmer 1	0.0
2	Light Dimmer 2	0.0
3	Light Dimmer 3	0.0
4	Var. Heat	0.0
5	W.O.D	0.0
6	<None>	0.0
7	<None>	0.0
8	<None>	0.0
Box 1	Card 1	Slot 3 Channel 1

### 8.4.5 STATIC PRESSURE

Observe the converter readings for the static pressure sensor. The nominal 'zero' pressure reading is 130. Remove the air hoses from the brass connectors on the left side outside of the controller to check this reading.

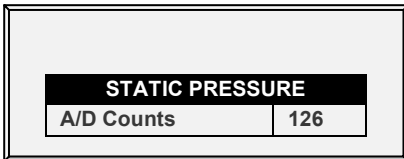

STATIC PRESSURE	
A/D Counts	126

### 8.4.6 COMMUNICATION

This menu facilitates testing on communication networks. A multiplexer in loop back mode is used to test communication. The Controller follows its' own communication to check for failed hardware. Follow the instructions displayed on the screen.

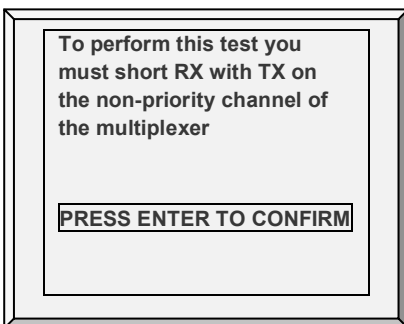

# 9 Appendix C: Layers Mode

This section details functions specific to the Platinum Touch Layers mode.

- Layers Main Screen
- Layers Vent and Curtain Levels

*NOTE Layers Mode supports up to 20 water meters.*

*NOTE To set the mode to Layers, refer to Selecting the Mode, page 15.*

## 9.1 Layers Main Screen

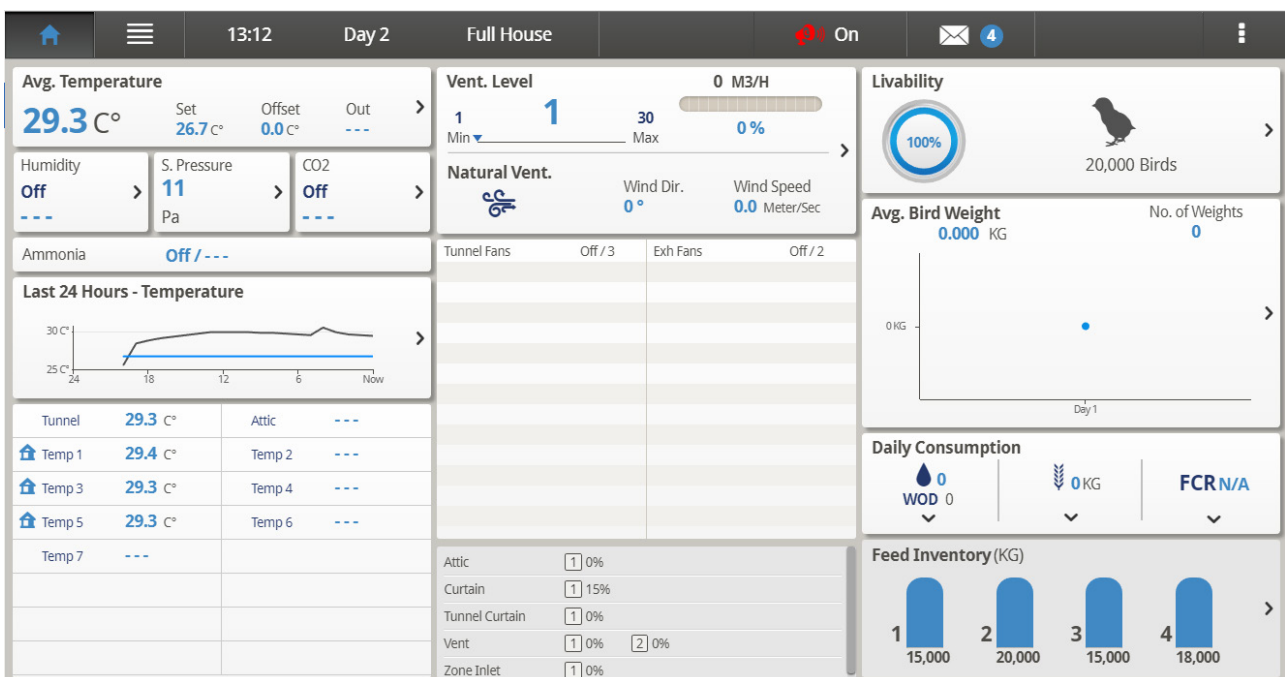

Figure 16: Layers Main Screen

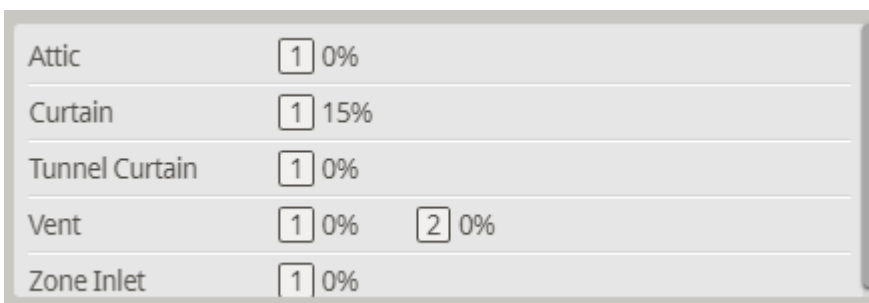

Figure 17: Layers Mode Active Sensors



## 9.2 Layers Vent and Curtain Levels

Set the curtain levels to correspond with the ventilation levels.

1. In *System > Relay Outlet*, define at least one relay as a Curtain Open, Tunnel Open, Vent Open, or Inlet Open.
2. In *Control > Temperature Curve*, define the Target Temperature.
3. In *System > Setup*, enable Natural Ventilation.
4. In *System > Level of Ventilation > Vent & Curtain*, define the working percentages.
5. Set the Help Set parameters as required.
  - **Ventilation Level:** Read-only.
  - **Tunnel/Inlet/Vent:** Set position for the tunnel curtain by level. If you have Static Pressure in Tunnel turned on ([Control | Static Pressure | Help | Set](#)), this becomes the minimum position for the tunnel inlet.

**NOTE** Refer to *Vent & Curtain Levels for Help Set details*.

### 9.2.1 LAYER INLET CONTROL

Inlets can be controlled via two methods:

- [Pressure](#): In this mode, inlets open and close according to the static pressure.
- [Position](#): In this mode, inlets open and close according to the temperature.

To select the inlet control method:

1. Go to *System > Levels of Ventilation > Vent and Curtain Control > Help*.
2. Go to Zone Inlet and select Press or Pos.

Vent & Curtain Levels - Settings			
Operate From Time	00:00	Operate To Time	00:00
Max Temperature To Disable Attic	37.8		
Zone Inlet			
Operation By S.Pressure / Position	Pressure	Compensation (%) Per Degree	1
Delay For Compensation (Min)	5	Max Compensation Opening	10
Temperature Compensation Hysteresis	0.3		

### 9.2.1.1 Pressure Control

When set to Pressure control, the inlets work similarly to vents; namely, the inlets open and close according to the static pressure. Each inlet is independent; no inlet controls another inlet. The number shown is the opening percentage.

Levels Of Ventilation							
Exhaust & Tunnel Fans		Vent & Curtain		Variable Speed Fans		Stir & Variable Stir Fans	
Level	Tunnel Level	Inlet		Attic Vent	Vent	Tunnel	Curtain
		Inlet Avg				Tunnel 1	Curtain 1
1	<input type="checkbox"/>	10		15	15	15	15
2	<input type="checkbox"/>	12		20	20	20	20
3	<input type="checkbox"/>	0		0	15	0	0
4	<input type="checkbox"/>	0		0	15	0	0
5	<input type="checkbox"/>	0		0	15	0	0
6	<input type="checkbox"/>	0		0	15	0	0
7	<input type="checkbox"/>	0		0	15	0	0
8	<input type="checkbox"/>	0		0	15	0	0
9	<input type="checkbox"/>	0		0	15	0	0

- Level: Read-only
- Inlet Average: Vent opening percentage
- Attic Vent: Attic opening percentage

*NOTE The remaining Help > Set parameters are not relevant when using Pressure control.*

To set pressure control:

1. At each level, place the cursor and type the inlet average level.
2. Press Enter.
3. Go to *System > Curtain Setup* and set the opening and closing times.

### 9.2.1.2 Position Control

When set to Position control, the inlets open and close according to the temperature. As the actual temperature differs from the target temperature, the inlet opens or closes. The number shown is the opening percentage.

Levels Of Ventilation										
Exhaust & Tunnel Fans		Vent & Curtain			Variable Speed Fans		Stir & Variable Stir Fans			
Level	Tunnel Level	Inlet			Tunnel	Curtain				
		Inlet Avg	Attic Vent	Vent	Tunnel 1	Curtain 1				
1	<input type="checkbox"/>	10	15	15	15	15				
2	<input type="checkbox"/>	12	20	20	20	20				
3	<input type="checkbox"/>	0	0	15	0	0				
4	<input type="checkbox"/>	0	0	15	0	0				
5	<input type="checkbox"/>	0	0	15	0	0				
6	<input type="checkbox"/>	0	0	15	0	0				
7	<input type="checkbox"/>	0	0	15	0	0				
8	<input type="checkbox"/>	0	0	15	0	0				
9	<input type="checkbox"/>	0	0	15	0	0				

- **Level:** Read-only.
- **Inlet Average:** Set the opening position for all inlets by level.
- **Inlet 1/2/3 – 12:** Set the opening level for an individual inlet by level. Set up to 12 inlets.

*NOTE When setting individual inlet openings, configure each inlet to work with a particular temperature sensor. Refer to Temperature Definition.*

To set position control:

1. At each level, place the cursor and type the opening level.
2. Press Enter.
  - Whichever parameter, the Inlet Avg or Inlet 1/2/3, is set last determines the opening level. For example, if you enter parameters for Inlet 1/2/3, and then enter the Inlet Avg parameter, this number overrides the Inlet 1/2/3 parameters.
  - Entering "0" disables the parameter.
3. Set the Help parameters as required.

## 9.2.2 LAYER VENT & CURTAIN (INLET) LEVELS HELP | SET DEFINITIONS

Vent & Curtain Levels - Settings					
Operate From Time	00:00	Operate To Time	00:00		
Max Temperature To Disable Attic	37.8				
Zone Inlet					
Operation By S.Pressure / Position	Pressure	Compensation (%) Per Degree	1		
Delay For Compensation (Min)	5	Max Compensation Opening	10		
Temperature Compensation Hysteresis	0.3				

- Define:

### Zone Inlet

- **Compensation % Per Degree:** For each degree that the actual temperature differs from the Target Temperature, the inlets:
  - open by this percentage (if the actual temperature is above the target temperature)
  - close by this percentage (if the actual temperature is below the target temperature)

For example, if the actual temperature is 2° above the target temperature, the inlet opens an additional 6%. Default: 1 %/°F

- **Delay for Compensation (minutes):** As the temperature sensors record changes in temperature, Platinum Touch/One waits this amount of time before changing the inlet position. Default: 5 minutes
- **Maximum Compensation Opening:** Inlet opening does not differentiate from the set level more than this amount, regardless of the temperature. Default: 10%
- **Temperature Compensation Hysteresis:** Temperature band defining when compensation begins. Default:  $\pm 0.5^{\circ}$  F

For example, if the Target Temperature is 80° and the Temperature Compensation Hysteresis is 1°, compensation begins above 81° or below 79°.

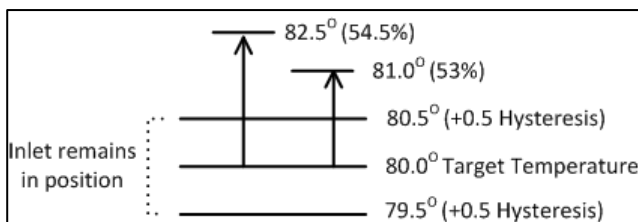

Figure 18: Example of Inlet Opening Hysteresis

Figure 25 illustrates an example of inlet hysteresis. An inlet is set to open to 50%, with a compensation of 3% for each degree. The target temperature is 80.0°, with a hysteresis of 0.5°. Between 79.5° to 80.5°, the inlet remains at 50%. If the temperature rises to 81.0°, the opening goes to 53%.

- **Motor Delay (seconds):** Time delay before motors that open or close zone inlets begin to operate.

# 10 Appendix D: Breeders Mode

This section details functions specific to the Breeders mode.

🔑 Control	Temperature Curve	Foggers	Egg Room Control
📁 Management	Min/Max Level	Water & Feed	Work Room Control
🕒 History	Humidity Treatment	Light	Nests
🔧 System	CO2 Treatment	Extra Systems	Feed Scale Program
	Natural Ventilation	Control Mode	Light Dimmers
	Static Pressure	System Parameters	
	Cool Pad	Ammonia Treatment	

- Egg Room Setup
- Egg Counter
- Egg Room Water and Feed
- Egg Belt Runtime
- Nest Function
- Work Room Control
- Scale Arm
- Weighing the Birds in Breeder
- Breeder Advanced Feeding
- Egg Room History

*NOTE To set the mode to Breeders, refer to Selecting the Mode, page 15.*

## 10.1 Egg Room Setup

The following procedures detail the steps required to set up the Egg Room functions.

1. In *System > Relay Layout*, define five relays as:
  - Egg room heater
  - Egg room fan 1
  - Egg room fan 2
  - Egg Room Cool
  - Humidifier

Relay Layout				
Relay No.	Device	No.	N.C.	
▾ Card 2 Main Slot 2				
11	Auger	2	<input type="checkbox"/>	
12	Feeder	1	<input type="checkbox"/>	
13	Water	1	<input type="checkbox"/>	
14	Egg Room Heat	1	<input type="checkbox"/>	
15	Egg Room Fan	1	<input type="checkbox"/>	
16	Egg Room Cooling	1	<input type="checkbox"/>	
17	E. R. Humidifier	1	<input type="checkbox"/>	
18	Nest Open	1	<input type="checkbox"/>	
19	Nest Close	1	<input type="checkbox"/>	
20	W.Room Heat	1	<input type="checkbox"/>	
▸ Card 3 Main Slot 3				

**NOTE** Refer to Relay Layout, page 125, for details on this screen.

2. In System > Sensors, > Analog Sensors set the input functions as Temperature Sensors and as an Egg Room Humidity sensor

**NOTE** Refer to Analog Sensors, page 127 for details on this screen.

3. In System > Temperature Definition, configure which temperature sensors operate in the egg room.

Temperature Definition						
Function	Sensors					
	1	2	3	4	5	6
Full House	<input checked="" type="checkbox"/>	<input checked="" type="checkbox"/>	<input checked="" type="checkbox"/>	<input checked="" type="checkbox"/>	<input checked="" type="checkbox"/>	<input checked="" type="checkbox"/>
Tunnel	<input type="checkbox"/>	<input type="checkbox"/>	<input type="checkbox"/>	<input type="checkbox"/>	<input type="checkbox"/>	<input type="checkbox"/>
Attic	<input type="checkbox"/>	<input type="checkbox"/>	<input type="checkbox"/>	<input type="checkbox"/>	<input type="checkbox"/>	<input type="checkbox"/>
Outside	<input type="checkbox"/>	<input type="checkbox"/>	<input type="checkbox"/>	<input type="checkbox"/>	<input type="checkbox"/>	<input type="checkbox"/>
Egg Room	<input checked="" type="checkbox"/>	<input type="checkbox"/>	<input checked="" type="checkbox"/>	<input type="checkbox"/>	<input checked="" type="checkbox"/>	<input type="checkbox"/>
W.Room	<input type="checkbox"/>	<input type="checkbox"/>	<input type="checkbox"/>	<input type="checkbox"/>	<input type="checkbox"/>	<input type="checkbox"/>
Stir Fan 1	<input type="checkbox"/>	<input type="checkbox"/>	<input type="checkbox"/>	<input type="checkbox"/>	<input type="checkbox"/>	<input type="checkbox"/>
Cool Pad 1	<input type="checkbox"/>	<input type="checkbox"/>	<input type="checkbox"/>	<input type="checkbox"/>	<input type="checkbox"/>	<input type="checkbox"/>
Tunnel 1	<input type="checkbox"/>	<input type="checkbox"/>	<input type="checkbox"/>	<input type="checkbox"/>	<input type="checkbox"/>	<input type="checkbox"/>

**NOTE** Refer to Temperature, page 130 for details on this screen.

**NOTE** After defining egg room temperature sensors, the egg room temperature appears on the main screen.

4. Using the Keyboard: In *Service > Humidity Calibration*, calibrate the Egg Room humidity sensor.

HUMIDITY CALIBRATION		
Sensor	Humidity°	Factor
In-1	58.9	2.3
In-2	58.9	2.3
Out	N/A	---
Egg Room	67	2.0

Press Left/Right Arrows to Calibrate

5. In *Control > Egg Room*, set the following on/off parameters:

- Heater temperature
- Fan 1 temperature
- Fan 2 temperature
- Cooling temperature
- Humidifier relative humidity percentage

Egg Room Control			
Heater (Temp) On	16.7	Heater (Temp) Off	18.9
Fan 1 (Temp) On	21.1	Fan 1 (Temp) Off	18.9
Fan 2 (Temp) On	21.1	Fan 2 (Temp) Off	18.9
Cooling (Temp) On	0.0	Cooling (Temp) Off	0.0
Humidifier (%rh) On	65	Humidifier (%rh) Off	70

6. In *Control > Egg Room Control > Help* configure the following alarm parameters:

- Low Temperature
- High Temperature
- Low Humidity
- High Humidity
- Delay (minutes)

Egg Room - Settings	
Alarm	
Low Temperature	17.0
High Temperature	22.0
Low Humidity	70
High Humidity	80
Delay (Min.)	60

The Breeder Mode is configured.

## 10.2 Egg Counter

Breeders Mode supports up to four egg counters per house. Platinum Touch/One supports Accucount infra-red egg counters (refer to the Egg Counter manual for details). The following sections detail the setup.

1. In *System > Digital Sensors*, define up to four sensors as Egg Counter.

Sensors		
Analog		Digital
Output No.	Function	Sensor No.
Card 1 Main Slot 1		
1	Egg Counter	1
2	Egg Counter	2
3	Egg Counter	3
4	Egg Counter	4
5	Egg Belt	1

2. Set the Alarms (refer to Alarm Setting Help | Set Definitions, page 87 for details on how to set alarms).

Egg Counter Alarm			
Alarm Active From	00:00	Alarm Active Untill	00:00
Low Egg House Count Eggs/minute	0	Low Count Alarm Delay (min.)	0

- **Alarm Active From/Untill:** Set the period for which the controller generates alarms.



- **Low Egg House Count Eggs/Minute:** Define the number of eggs per minute at which an alarm is generated.
- **Low Count Alarm Delay (min):** Set the minimum period of time low egg count must extend through before generating an alarm

3. The Main Screen displays the current day's total egg count.

Tunnel	25.6 C°	Egg Room	25.6 C°
W.Room	---	Feed Area	---
Attic	---	🏠 Temp 1	25.6 C°
Temp 2	---	🏠 Temp 3	25.6 C°
Temp 4	---	🏠 Temp 5	25.6 C°
Temp 6	---	Eggs 1	2590
Eggs 2	2145	Eggs 3	1489
Eggs 4	1768		

4. To test the egg counter sensor(s), on the Keyboard, go to Test > Digital Sensors.

DIGITAL IN TEST			
In.	Sensor	State	Counter
1	Egg Counter 1	1	0
2	Egg Counter 2	0	0
3	Egg Counter 3	0	0
4	Egg Counter 4	0	0
5	<None>	0	0
6	<None>	0	0
7	<None>	0	0
8	<None>	0	0

5. In History > Egg Counters, view the total egg count.

Eggs History				
Day	1	2	3	4
1	2590	2145	1489	1768

### 10.3 Egg Room Water and Feed

In Breeder Mode, the water and feed schedule is independent of the growth day. In addition, Breeder Mode enables lowering the target temperature during the feeding time. When birds begin to feed, they congregate near the feeders and the temperature rises (which negatively affects the birds' feed intake). To compensate, increase the ventilation before/during the feeding time by lowering the target.

### 10.3.1 SETUP

1. Go to *Control > Water & Feed*.

Water & Feed Control			
From Time	To Time	Water	Feeder
		1	1
05:00	07:00	●	●
09:00	10:00	●	●
00:00	00:00	X	X
00:00	00:00	X	X
00:00	00:00	X	X

2. Set the parameters as required:

- Time: Set event times for water, feeder, or auger.
- Set the water, feeder, and auger lines to Continuous, Cycle, or Off.

3. In *System > Setup*, define *Feed Area* as *Yes*.

**NOTE** If you do not define *Feed Area* as *Yes*, *Feed Area* does not appear in *Temperature Definition*.

4. In *System > Temperature Definition*, map a temperature sensor(s) to the feed area (optional).

5. Go to *Control > Water & Feed > Help* (optional).

#### Water & Feed - Settings

Temp Target Adjust

Change Target From	00:00	Change Target To	00:00
Target Offset	0.0		

Feed Line Operation

Line 1 Down	00:00	Line 1 Up	00:00
Line 2 Down	00:00	Line 2 Up	00:00

6. If a device is set to *Cycle*, define the *Water/Feeder/Auger On* and *Off* times.

7. To adjust the target temperature during feeding (to increase ventilation):

- a. Define the *To/From* times.
- b. Define the *Target Temperature Offset* (to reduce the target).

**NOTE** To disable this feature set the offset to *0*.

8. To control the male breeders feeding time:

- a. Under Feed Line Operation, define when the lines descend and rise (Line Down, Line Up times).
- b. On the keyboard: Go to *Service > Feed Line Calibration*.
- c. Enter the amount of time required for the curtains to rise and descend.

*NOTE Measure these times if you don't know them.*

FEED LINE CALIBRATION	
Function	Run Time (sec).
Feed Line 1 Up	60
Feed Line 1 Down	50
Feed Line 2 Up	80
Feed Line 2 Down	40

**Additional points:**

- In Breeder Mode, Platinum Touch/One supports up to:
  - 10 feeders
  - Four water lines
  - Four augers
- Define these functions in System > Relays.
- To and From times can overlap. For example, in the table above one line goes from 4:45 to 5:15 and the next line goes from 5:00 to 5:30. If there is overlap and contradictory configurations, the priority is Continuous > Cycle > Off. In the example above:
  - Water Line 2 will run in a cycle from 5:00 until 5:30.
  - Feeder Line 1 will be from 4:45 until 5:15, even though line 3 turns off the feeder.

### 10.3.2 WATER AND FEED VERSION 7.24 AND ABOVE

When running Platinum Touch in Breeder Basic Mode, Version 7.24 and above Water, Feeder, and Auger Tables appear in separate windows; each window can be configured independently. The functionality and configuration is the same as in Version 7.23.

Feed		Feeder	
From Time	To Time	1	2
05:00	05:30	●	X
07:00	08:00	●	X
09:00	09:30	●	●
00:00	00:00	X	X

Auger		Auger	
From Time	To Time	1	2
05:00	05:30	●	X
06:00	07:00	●	X
08:00	09:00	●	●
00:00	00:00	X	X

Water		Water	
From Time	To Time	1	2
04:00	04:30	●	X
05:30	06:30	●	X
08:00	09:00	●	X
00:00	00:00	X	X

## 10.4 Egg Belt Runtime

Platinum Touch/One Breeder supports measuring the egg belt runtime.

- Install digital input cards.
  1. Go to *System > Digital Sensors*.
  2. Define at least one sensor as Egg Belt.

Sensors		Digital	
Output No.	Function	Sensor No.	
↳ Card 1 Main Slot 1			
1	Egg Counter	1	
2	Egg Counter	2	
3	Egg Counter	3	
4	Egg Counter	4	
5	Egg Belt	1	

3. Go to *History > Egg Belt Run Time* to view the data.

## 10.5 Nest Function

The Nest function enables opening and closing (up to) four Nest lines at specific times. Birds can then leave their Nests and return.

For users employing Version 7.18 and below, refer to Appendix E: Functions in Previous Versions.

In Version 7.19, the nest function operates in two different manners, depending on the number of relays required to open and close the nests.

- Single Relay
- Dual Relay

### 10.5.1 SINGLE RELAY

When using a single relay:

- applying electricity opens the cages
- ceasing the electricity closes the cages.

The user defines when the relay opens (allows current) and when the relay closes (ceases current), thereby opening or closing the cage.

1. In *System > Relay Layout* designate up to four relays as Nest Open relays. The number of defined relays is what appears in the screen.

**NOTE** *In this setup there is no need to designate relays as Nest Close.*

2. In *Control > Nests > Set Definitions*, define the Nest Mode as Single (default is Dual).

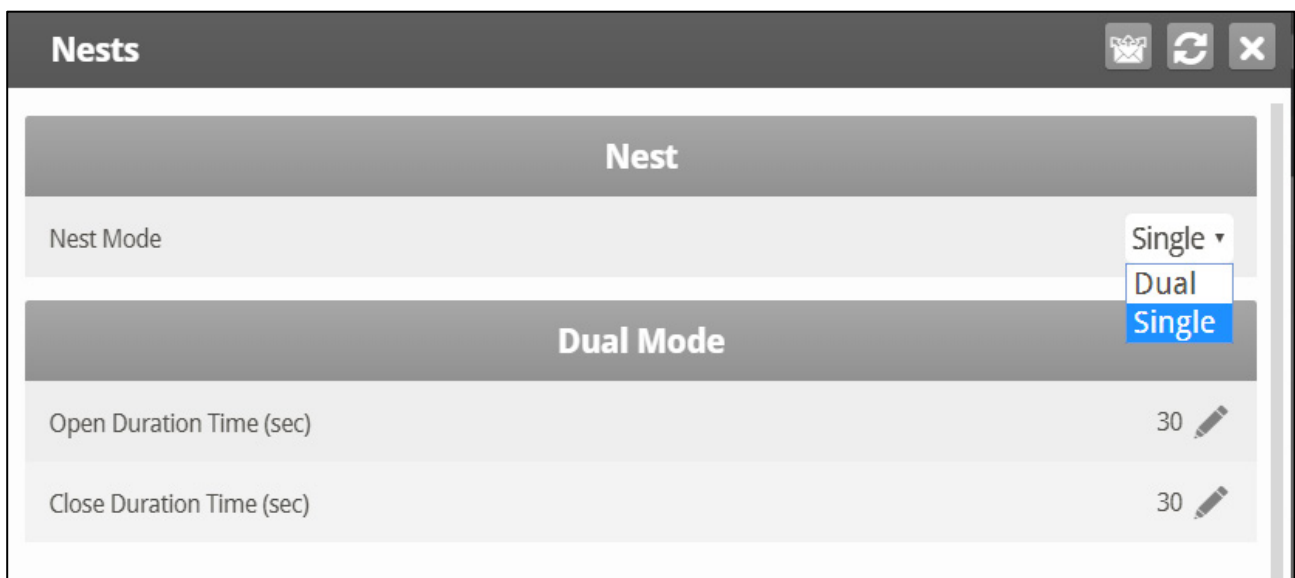

3. In *Control > Nest*, define the:

- *Time: This schedules when the relay enables or disables current to flow (daily).*
- *Nest: Under each nest, define if it opens or closes.*

*In the example below, Nests 3 and 4 open at 12:00 and close at 15:00. Nests 1 and 2 open at 15:00 and remain open until 12:00 the following day.*

Nests		Nests			
Number	Time	1	2	3	4
1	12:00	Off	Off	On	On
2	15:00	On	On	Off	Off
3	00:00	Off	Off	Off	Off

## 10.5.2 DUAL RELAY

When using dual relays, one relay opens the cage and the second closes the cage. A specific command must be given for each function. Cages remain open or closed until a command is given to change the status.

1. In *System > Relay Layout* designate up to four relays (each) as Nest Open and Nest Close relays. The number of defined relays is what appears in the screen.
2. In *Control > Nest > Set Definitions*, define the Nest Mode as Dual (default is Dual).

Nest	
Nest Mode	Dual
<b>Dual Mode</b>	
Open Duration Time (sec)	30
Close Duration Time (sec)	30

3. Define the time required to open or close the cage.
4. In *Control > Nest*, define the:
  - Time: This schedules a relay is activated.
  - Nest: Under each nest, define which relay operates on a nest.
    - Open: Nest opens
    - Close: Nest closes
    - None: No action (relay is closed or released)

*In the example below, Nests 3 and 4 open at 12:00. Nest 2 opens at 15:00. Nest 3 closes at 16:00, while Nests 2 and 4 remain open.*

Nests		Nests			
Number	Time	1	2	3	4
1	12:00	None	None	O	O
2	15:00	None	O	None	None
3	16:00	None	None	C	None
4	00:00	None	None	None	None

## 10.6 Work Room Control

This screen enables controlling the temperature in the work room.

Work Room Control		
Function	On	Off
Heater 1 (Temp)	16.7	18.9
Heater 2 (Temp)	16.7	18.9
Fan 1 (Temp)	21.1	18.9
Fan 2 (Temp)	21.1	18.9

1. In *Control* > *Work Room Control*, set the following on/off parameters:

- Heater 1 and 2 temperatures
- Fan 1 temperature
- Fan 2 temperature

2. In *System* > *Temperature Definition*, define 1 or 2 sensors as Work Room temperature sensors (refer to Temperature Definition, page 130 for details on this function)

Temperature Definition						
Function	Sensors					
	1	2	3	4	5	6
Full House	<input checked="" type="checkbox"/>	<input checked="" type="checkbox"/>	<input checked="" type="checkbox"/>	<input checked="" type="checkbox"/>	<input checked="" type="checkbox"/>	<input checked="" type="checkbox"/>
Tunnel	<input type="checkbox"/>	<input type="checkbox"/>	<input type="checkbox"/>	<input type="checkbox"/>	<input type="checkbox"/>	<input type="checkbox"/>
Attic	<input type="checkbox"/>	<input type="checkbox"/>	<input type="checkbox"/>	<input type="checkbox"/>	<input type="checkbox"/>	<input type="checkbox"/>
Outside	<input type="checkbox"/>	<input type="checkbox"/>	<input type="checkbox"/>	<input type="checkbox"/>	<input type="checkbox"/>	<input type="checkbox"/>
Egg Room	<input checked="" type="checkbox"/>	<input type="checkbox"/>	<input checked="" type="checkbox"/>	<input type="checkbox"/>	<input checked="" type="checkbox"/>	<input type="checkbox"/>
W.Room	<input type="checkbox"/>	<input checked="" type="checkbox"/>	<input type="checkbox"/>	<input checked="" type="checkbox"/>	<input type="checkbox"/>	<input type="checkbox"/>
Stir Fan 1	<input type="checkbox"/>	<input type="checkbox"/>	<input type="checkbox"/>	<input type="checkbox"/>	<input type="checkbox"/>	<input type="checkbox"/>
Cool Pad 1	<input type="checkbox"/>	<input type="checkbox"/>	<input type="checkbox"/>	<input type="checkbox"/>	<input type="checkbox"/>	<input type="checkbox"/>
Tunnel 1	<input type="checkbox"/>	<input type="checkbox"/>	<input type="checkbox"/>	<input type="checkbox"/>	<input type="checkbox"/>	<input type="checkbox"/>

## 10.7 Scale Arm

During feed distribution, each silo has a mechanical arm that disconnects at the end of a feed cycle, preventing further distribution. When this disconnect happens, a signal is sent from the arm to the silo, informing the latter that it must be refilled. Platinum Touch/One enables recording these signals in the Events History.

To define the Scale Arm:

1. Go to System > Digital Sensors.
2. Define one sensor as Scale Arm.

Sensors		
Analog		Digital
Output No.	Function	Sensor No.
Card 1 Main Slot 1		
1	Egg Counter	1
2	Egg Counter	2
3	Egg Counter	3
4	Egg Counter	4
5	Egg Belt	1
6	Scale Arm	1
7	Intermediate	1
8	Hopper	1
9	Heat Exchanger	1



- In History > Table of Events, Feed Delivered appears when the mechanical arm disconnects.

Day	Time	Message
1	15:15:30	Cold Start
1	15:15:30	Min Ventilation
1	15:15:30	Feed Delivered

## 10.8 Weighing the Birds in Breeder

The following section details how to set up scales to weigh the birds.

- ➔ **Scale Layout:** Use the process detailed in the Broiler Section. Refer to Scale Layout, page 136.
  - Bird Scale Setting
  - Bird Weight History

### 10.8.1 BIRD SCALE SETTING

There are two options for setting up the curve used as a reference weight for the bird weights, using a controller-generated curve and using an industrial standard curve.

- Measuring Bird Weights, Auto Curve
- Measuring Bird Weights, Customized/Industrial Standard Curve

#### 10.8.1.1 Measuring Bird Weights, Auto Curve

1. Go to System > Scale > Bird Scale Setting.

2. In Weighing Method, select Auto.
3. Go to System > Scale > Bird Scale Setting > Help. Define the parameters (option).

**Scale Setting**

**FEMALE**

Upper Range 10

Lower Range 15

**MALE**

Upper Range 15

Lower Range 10

- Male/Female: The upper/lower range parameters defines the range of weights that are recorded. The weights of birds that exceed differ from the bird curve by these amounts are discarded. Note that the default range of the female and male bird are reversed.

4. Go to System > Bird Weight.

**Bird Weight**

Description	Value
Current Female Weight	0.042
Current Male Weight	0.042

5. The Bird Weight screen displays the target weight for the current growth day for each gender. Edit the weight as required.

### 10.8.1.2 Measuring Bird Weights, Customized/Industrial Standard Curve

1. Go to System > Scale > Bird Scale Setting.

**Scale Settings**

**Bird Scale** | Silo

Weight Method Curve ▾

Scale 1 Female Weight ▾

Scale 2 Female Weight ▾

Scale 3 Male Weight ▾

Scale 4 Male Weight ▾

2. In Weighing Method, select Curve.

3. Go to Scale > Bird Scale Setting > Help. Define the parameters (option).

- Male/Female: The upper/lower range parameters defines the range of weights that are recorded. The weights of birds that exceed differ from the bird curve by these amounts are discarded. Note that the default range of the female and male bird are reversed.

4. Go to System > Bird Weight > Help.

5. Define the parameters:

- Curve Offset: Enter the factor used to adjust the weight curve. This amount is added to the curve. Range: -4.40 to +4.41 Kg/Lb.
- Select Curve:
  - Custom: the Bird Weight screen displays a generic curve for each day's target weight. You can edit the weight as required.
  - Factory default curve: The Bird Weight screen displays each day's target weight using an industry standard. These data points are read-only. Note that there are different curves for female or male birds.

6. Go to System > Bird Weight.

Day	Female	Male
0	0.042	0.042
7	0.160	0.150
14	0.285	0.340
21	0.410	0.525
28	0.540	0.690
35	0.645	0.830
42	0.750	0.960
49	0.850	1.090
56	0.950	1.220
63	1.050	1.345
70	1.160	1.470
77	1.250	1.595

- The Bird Weight screen displays the target weight for the current growth day for each gender.
  - If you selected Custom in Help, edit the fields as required.
  - If you selected an industrial standard, all fields are read-only.
- Note: If you select Custom, the controller saves all changes that you make to the fields. Meaning that after configuring a customized curve, you can go to the Help, select an industrial curve, and then go back and select Custom. The curve that you defined will reappear.

### 10.8.2 BIRD WEIGHT HISTORY

The scale history shows bird weight statistics for female and male houses. You can review daily data for each gender or for each scale.

Day	Female Weight			Male Weight			Scale 1		
	Average	Uniformity	No.	Average	Uniformity	No.	Average	Uniformity	No.
1	0.000	0	0	0.000	0	0	0.000	0	0

### 10.9 Breeder Advanced Feeding

Breeder Mode supports a unique feed mixing and distribution system that includes:

- Mixing feed from up to eight silos
- Distributing the feed to up to eight different feed lines
- Differentiating between male, female, or mixed sex lines
- Support for up to 24 feeding stations (16 female and 8 males)

In this system (up to eight) silos place their feed onto auger lines, which transports the feed to a feed scale container. The feed is mixed in the feed scale container and then placed into hoppers, from which the feed is transported to the birds. What is unique in this program is the flexibility in designing feeding lines for male, female, and mixed lines. Using the program, you define the entire feeding program:

- mapping silos to augers
- how much feed from each silo
- what type of feeding program to use
- which feeding stations are active

How does it work?

- Silos deliver feed to the feed scale container; the user defines how much feed each silo delivers (in percentages of the total weight).
- After delivering the feed, the silo augers are turned off and feed is placed in the hopper from which the feed is then placed into feed lines.
- Each hopper delivers feed to one or two lines:
  - If one feed line is used it can supply to feed to males, females, or both.
  - If two feed lines are used, one line is designated for the males and one line is designated for females
- When the hopper empties, the process repeats itself until the supplied feed equals the defined target.
- Continuous feeding: You In standard feeding, the feed line hoppers are filled serially. A line hopper valve does not open until the previous valve closes. In the advanced feeding mode, you can configure the setup to ensure that the delays between the feed line hopper fillings overlap.

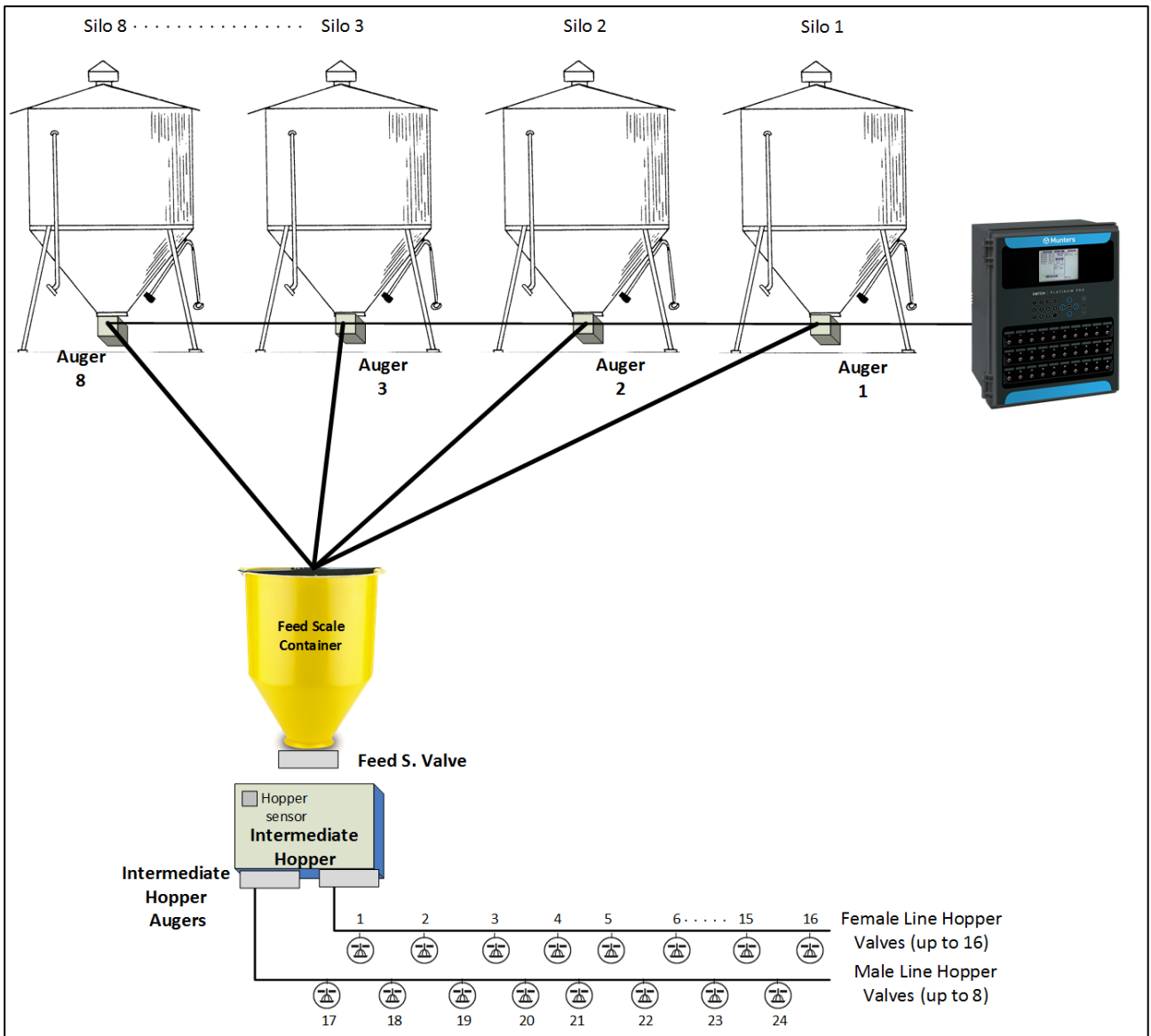

Figure 19: Dual Line Block diagram

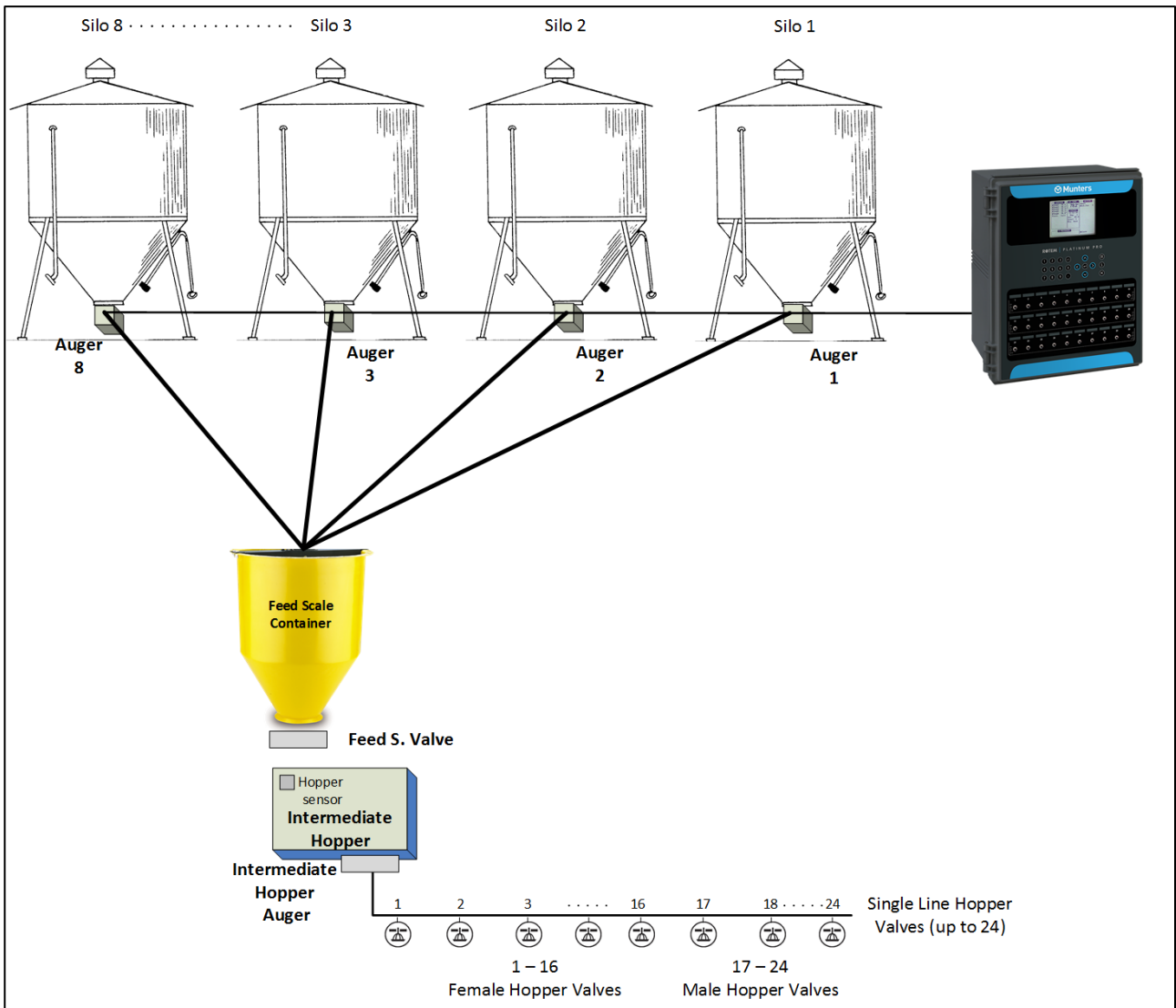

Figure 20: Single Line Block diagram

### 10.9.1 SELECTING THE MODE



To enable the Breeder advanced feeding mode:

1. Disconnect the power cable from the power source.
2. Reapply power while pressing Delete. The Cold Start screen appears.
3. Select Yes. The Choose Controller Type appears.
4. Select Breeder.
5. Select Precision.
6. Select Advanced Feeding.
7. Press Enter.

## 10.9.2 SETUP

Warning: Do not configure these screens while a feeding cycle is in progress.

1. Go to System > Relays.

Relay Layout					
Relay No.	Device	No.	N.C.		
▶ Card 4 Main Slot 4					
◀ Card 5 Main Slot 5					
41	Auger ▼	3	<input type="checkbox"/>		
42	Auger ▼	4	<input type="checkbox"/>		
43	Auger ▼	5	<input type="checkbox"/>		
44	Auger ▼	6	<input type="checkbox"/>		
45	Auger ▼	7	<input type="checkbox"/>		
46	Line Hopper Valve ▼	3	<input type="checkbox"/>		
47	Line Hopper Valve ▼	2	<input type="checkbox"/>		
48	Line Hopper Valve ▼	4	<input type="checkbox"/>		
49	Line Hopper Valve ▼	5	<input type="checkbox"/>		
50	None ▼	0	<input type="checkbox"/>		

2. Define:

- Up to eight relays as augers.
  - As an option, you can manually number the augers.
- One Feed Scale Valve (Version 7.22)
- Up to two intermediate hopper augers.
- Up to 24-line hopper valves.
  - Platinum Touch/One defines line hopper valves 1 – 16 as being female line hopper valves and valves 17 – 24 as being male line hopper valves.

*NOTE In Version 7.20, Platinum Touch/One support 16 male line hoppers (17 – 32).*

- If you are not using all 16 female valves or all 8 male valves, you can manually number the valves. For example, four valves can be numbered as 1 – 4 and the fifth valve numbered as 17.
- Number the female and male valves sequentially. For example:
  - 1 – 4 or 5 – 7 and 17 – 20 or 21 – 24 are fine.
  - 1, 4, 7, 9 and 17, 21, 24 is incorrect.

3. Go to Control > Water & Feed.



Water & Feed Control							
From Time	To Time	Water			Feeder		
		1	2	3	1	2	3
06:00	06:45	●	X	X	●	X	X
08:00	09:00	●	X	X	●	X	X
10:00	10:30	●	○	X	●	○	X
00:00	00:00	X	X	X	X	X	X
00:00	00:00	X	X	X	X	X	X
00:00	00:00	X	X	X	X	X	X
00:00	00:00	X	X	X	X	X	X
00:00	00:00	X	X	X	X	X	X
00:00	00:00	X	X	X	X	X	X
00:00	00:00	X	X	X	X	X	X
00:00	00:00	X	X	X	X	X	X

4. Set the parameters as required:

- Time: Set event times for water or feeder.
- Set the water or feeder lines to Continuous, Cycle, or Off.

5. Go to Control > Water & Feed > Help.

### Water & Feed - Settings

#### Temp Target Adjust

Change Target From 05:55 Change Target To 08:00

Target Offset -5.0

#### Feed Line Operation

Line 1 Down 04:45 Line 1 Up 05:00

Line 2 Down 04:45 Line 2 Up 05:00

#### Water Cycle Time

Cycle On (Min.) 30 Cycle Off (Min.) 270

#### Feeder Cycle Time

Cycle On (Min.) 60 Cycle Off (Min.) 200

#### Feed Day Cycle

Feed Day Cycle Daily

6. If a device is set to Cycle, define the Water/Feeder On and Off times.

7. To adjust the target temperature during feeding (to increase ventilation):

- Define the To/From times.
- Define the Target Temperature Offset (to reduce the target).

*NOTE To disable this feature set the offset to 0.*

- Feed Cycle: Set to:
  - Daily: Same schedule for every day of the week.
  - 2 – 6 Days: Select a cycle that lasts the number of days chosen and then repeats itself. For example, 2 Days means that the cycle lasts two days and then repeats itself.
  - Week: Set a cycle for specific days.

*NOTE When the cycle is set to 2-6 days or Week, you can skip specific days by pressing the +/- key.*

8. Go to System > Silo/Auger Layout.

Silo	Auger	Device No	Feed Type
Silo 1	Auger <input type="radio"/>	1	Both
Silo 2	Auger <input type="radio"/>	2	Both
Silo 3	Auger <input type="radio"/>	3	Female
Silo 4	Auger <input type="radio"/>	4	Female
Silo 5	Auger <input type="radio"/>	5	Male
Silo 6	Auger <input type="radio"/>	6	Male
Silo 7	Auger <input type="radio"/>	7	None
Silo 8	Auger <input type="radio"/>	8	Both

9. Map each silo to the auger number.

- To use this function, augers must be defined in System > Relay Layout. No mapping is possible unless augers have been defined.
- By default, the screen displays four silos and augers. If you define more than four relays as augers (or if you number even one auger relay as number 5 or higher), the screen displays eight silos.
- Even if all eight silos appear on the screen, the number of silos you can map equals the number of auger relays defined.
- Define the parameters:
  - Silo: Read only number.
  - Auger: This defines which auger is mapped to which silo. Define this as None (disabling the auger line) or Auger. Platinum Touch/One numbers the auger but you can manually edit the number. To edit, press the required number and then **Enter**.
  - Feed Type: If the silo contains feed designated for males or females, define that feed type in this parameter. Alternatively, define the feed type as Both (default) or None.

10. In Management > Feed Inventory, enter the quantity of feed in each silo. Note that if the silos are equipped with load cells, this table is filled automatically.

Date	Silo							
	1	2	3	4	5	6	7	8
23-Sep-18	8,000	9,000	9,000	10,000	9,000	15,000	8,000	10,000
23-Oct-18	0	0	0	0	0	0	0	0
--	0	0	0	0	0	0	0	0
--	0	0	0	0	0	0	0	0
--	0	0	0	0	0	0	0	0
--	0	0	0	0	0	0	0	0
--	0	0	0	0	0	0	0	0
--	0	0	0	0	0	0	0	0
<b>Total Feed</b>	8,000	9,000	9,000	10,000	9,000	15,000	8,000	10
<b>Active</b>	<input checked="" type="checkbox"/>	<input type="checkbox"/>	<input type="checkbox"/>	<input type="checkbox"/>	<input type="checkbox"/>	<input type="checkbox"/>	<input type="checkbox"/>	<input type="checkbox"/>

11. Go to Control > Feed Scale Program.

*NOTE This screen is wide and requires scrolling to view all parameters.*

No	Start Time	Type	Silo Augers (in %)								Inter. Hopp	
			1 F M	2 F M	3 F	4 F	5 M	6 M	7 N	8 N		
1	05:00	None	0	0	0	0	0	0	0	0	0	--
2	10:00	Female	0	50	0	50	0	0	0	0	0	1
3	07:00	Male	75	25	0	0	0	0	0	0	0	2
4	12:00	Both	34	33	33	0	0	0	0	0	0	1&2
5	00:00	None	0	0	0	0	0	0	0	0	0	--
6	00:00	None	0	0	0	0	0	0	0	0	0	--
7	00:00	None	0	0	0	0	0	0	0	0	0	--
8	00:00	None	0	0	0	0	0	0	0	0	0	--
9	00:00	None	0	0	0	0	0	0	0	0	0	--
10	00:00	None	0	0	0	0	0	0	0	0	0	--
11	00:00	None	0	0	0	0	0	0	0	0	0	--

Note: This screen's appearance depends on the relay layout and silo/auger layout.







- Version 7.23: All silos appear in the Feed Scale Program screen.
- Version 7.24: Only those silos actually mapped to an auger in Silo > Silo Auger Layout appear in the Feed Scale Program screen.

12. Define the feed mixture and distribution parameters.



- Number: You can define up to 20 feeding times per day.
- Type: Designate this feeding time as one of the following:
  - Female or Male. When defined as Female or Male, only those augers whose feed type matches this definition will add feed to the mixture. For example, if Number 1 is defined as Male, any auger defined as Female will not add feed at this time. However, an auger defined as Both will add feed. (Augers are defined in Scale > Silo/Auger Layout > Feed Type)

- Both: When defined as Both, any auger that is defined Male, Female, or Both can add feed to the mixture.
- None: In this option (None Active), you cannot edit that line's parameters.
- Erase: This option erases any parameter definitions for that number.
- Silo Augers (%): Under each auger, enter the percentage of feed that each silo provides. The default auger automatically adjusts its percentage as you define each auger's percentage.
  - In a line designated as Male or Female, you can only change the percentages of those augers matching the definition (or an auger defined as Both).
    - For example: If the line is defined as male, only augers defined as Male or Both can add feed. The cursor will automatically skip over any auger not matching the line definition.
    - Augers defined as None do not add feed.
- Inter. Hopper Auger: This parameter is read-only. If one auger is defined is defined, 1 appears. If two augers are defined, either one or two can appear.
  - If there is one auger line, this line can feed males, females, or both (up to 24 valves).
    - Valves 1 – 16 are female,
    - Valves 17 – 24 are male (see Figure 1)
  - If there are two auger lines:
    - The Intermediate Hopper Auger 1 relay MUST be mapped to the line feeding the females.
    - The Intermediate Hopper Auger 2 relay MUST be mapped to the line feeding the males.
- Line Hopper Valves: Define the amount of feed that each feeding station receives.
  - Version 7.21: Range 0 – 22025 Lbs/0 -9999 Kg
  - Version 7.22: Range 0 – 22025.8 Lbs/0 -9999.9 Kg

## 10.9.3 FEED SCALE PROGRAM HELP | SET DEFINITIONS

System Parameters	
Max Portion Weight	55 
Max Auger Time (Min)	10 
Not Empty Time (Min)	60 
Stop Diff Weight	2.2 
Optimizer	Default 
Valve Close Time (Sec.)	7 
Feed Tare [A/D count]	0 

1ST Line of Hoppers	
Auger Feed Rate [weight/min]	44 
Time To First Line Hopper [sec]	120 
Time To Last Line Hopper [sec]	240 

- Define:

### ADVANCED FEEDING SETTINGS

- **Maximum Portion Weight:** Enter the feed scale container size.
- **Maximum Auger Time [minutes]:** This parameter sets an alarm for the auger running time. Enter the number of minutes that the auger can run, after which an alarm appears on the Main Screen.
- **Not Empty Time:** This parameter (in minutes) sets an alarm for the feed scale container. The container should distribute all its feed to the feed lines. If feed remains in the container, it could mean that there is a problem (for example, the valve doesn't open). Set the amount of time that feed can remain in the container, after which an alarm appears on the Main Screen.
- **Stop Band Weight:** This parameter (kilos or pounds) defines the band at which augers cease to distribute feed. When the amount of feed distributed approaches the maximum portion weight by this amount, the controller ceases the distribution.
- **Optimizer:** This parameter sets the unit's sensitivity to signal noise (caused by a variety of factors). The sensitivity plays a role as the controller stabilizes itself. Greater amounts of noise require faster optimization. To view an indication of the controller's stability, go to *Scale Menu > Test* (refer to page 159) and perform a test. If the number remains stable, slower optimization is indicated. There are three settings: Default, Slower, Faster.

**NOTE** Munters recommends leaving this parameter at the default level.

- **Valve Close Time [seconds]:** Set the delay in time, if any, that the valve emptying the feed scale container closes.

- **Feed Tare [A/D count]:** This specification is used for certain tests performed by a certified technician.

*NOTE Munters recommends leaving this parameter unedited.*

### Female/Male Line of Hoppers

- **Auger Feed Rate (weight/min):** Define the amount of feed to be sent to the birds over a defined amount of time.

*NOTE If you define one relay only as the Inter. Hopper Auger, enter the same rate in both the Female and Male Line of Hoppers.*

- **Time to 1st Hopper:** Amount of time required for feed to travel from the intermediate hopper to the first hopper valve.
- **Time to Last Hopper:** Amount of time required for feed to travel from the intermediate hopper to the last hopper valve. Note that the last valve is the last valve actually defined. For example if six valves are defined, enter the amount of time required for the feed to reach valve number six.
- **Line Hopper Feed Gap:** The amount of time required for feed to travel the distance between each hopper.

## 10.10 Egg Room History

- Go to *History > Egg Room* to view a daily history of the egg room temperature and humidity. Press the right/left arrow keys to switch between views.

<b>Egg Room</b> <span style="float: right;"> </span>						
Day	Temperature			Humidity		
	Min	Avg	Max	Min	Avg	Max
1	25.4	28.2	28.4	---	---	---

# 11 Appendix E: Functions in Previous Versions

This chapter provides information on specific functions for people employing previous versions.

- Bird Weighing, Version 7.21 and Below
- Scale Test, Version 7.17 and Below
- Vent & Curtain Levels Help | Set Definitions Version, 7.18 or Below
- Breeder Nest Function, Version 7.18 and Below

## 11.1 Bird Weighing, Version 7.21 and Below

- Setting up a Curve – Summary
- Bird Curve/Bird Weight
- Scale Settings
- Gender Based Weighing
- Silo / Auger Layout Version 7.17 and Below
- Bird Weight History, Version 7.18 and Below

### 11.1.1 SETTING UP A CURVE – SUMMARY

*NOTE A Scale Card or RSU must be installed.*

In Versions 7.19 or above, setting up a bird curve means defining the following items:

- [Silo / Auger Layout](#): Define at least one scale.
- [Bird Scale Setting Screen](#): Define the curve type (Auto, Custom, or Cobb/Robb)
- [Bird Weight](#): Define the curve data points (day and weight; Custom or Cobb/Robb curves only).

In Versions 7.18 or below, setting up a bird curve means defining the following items in the Scale Menu:

- [Silo / Auger Layout](#): Define at least one scale.
- [General Settings](#): Define the curve type (broiler, breeder, turkey)
- [Bird Scale](#): Define the curve parameters.
- [Bird Curve](#): Define the curve data points (day and weight).

In Versions 7.21 or above there is an additional option enabling [gender-based weighing for birds](#).

## 11.1.2 BIRD CURVE/BIRD WEIGHT

This section describes the Bird Scale Settings for Broiler mode. Refer to Breeder and Layer Mode appendices to view the function for those modes.

- Bird Curve, Version 7.18 and Below
- Bird Weight, Version 7.19

### 11.1.2.1 Bird Curve, Version 7.18 and Below

This screen displays data according to growth day for broilers, turkeys, or breeders, previously set in [General Settings](#).

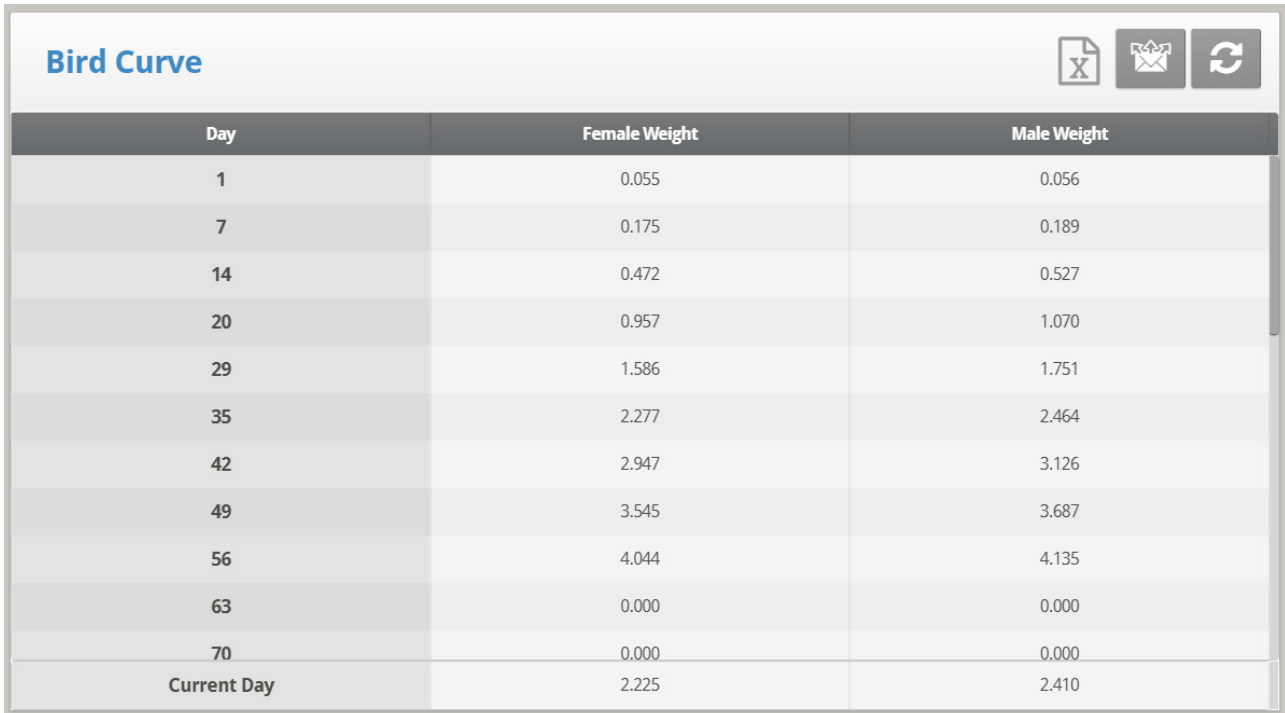

Day	Female Weight	Male Weight
1	0.055	0.056
7	0.175	0.189
14	0.472	0.527
20	0.957	1.070
29	1.586	1.751
35	2.277	2.464
42	2.947	3.126
49	3.545	3.687
56	4.044	4.135
63	0.000	0.000
70	0.000	0.000
Current Day	2.225	2.410

Edit the growth days and weights for the bird curves to fit your requirements.

#### 11.1.2.1.1 Bird Curve Help | Set Definitions

This screen displays the expected bird weight according to growth day for broilers, turkeys, or breeders.

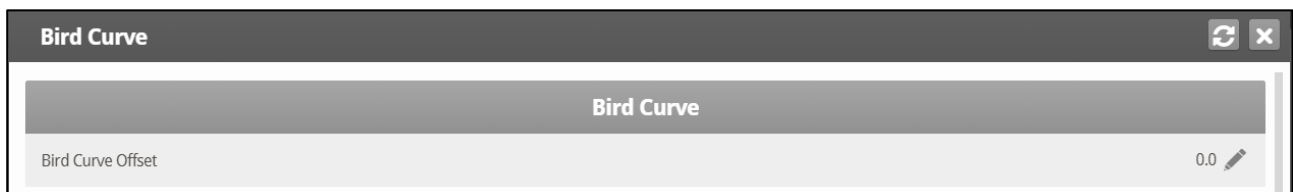

- Define the following parameter:
  - Bird Curve: Enter the factor used to adjust the weight curve. This amount is added to the “Now” field. Range: 0.0 – 10.0 Kg/Lb.

### 11.1.2.2 Bird Weight, Version 7.19

This screen displays the expected bird weight according to growth day. Which screen is displayed is dependent on the curve selected in Bird Scale Setting, Version 7.19 (page 200).

- Bird Weight Screens



- Bird Weight Help | Set Definitions

### 11.1.2.2.1 Bird Weight Screens

- Auto Method

Bird Weight	
Description	Value
Current Weight	0.042

- If you selected Auto in Bird Scale Setting, the Bird Weight screen displays the target weight for the current growth day. You can edit the weight as required.

- Custom Weight

Bird Weight	
Day	Weight
0	0.000
1	0.000
2	0.000
3	0.000
4	0.000
5	0.000
6	0.000
7	0.000
8	0.000
9	0.000
10	0.000
11	0.000

- If you selected Custom in Bird Scale Setting: Edit the weights as required.

- Factory Default Curve

Bird Weight	
Day	Weight
0	0.042
1	0.063
2	0.074
3	0.090
4	0.109
5	0.134
6	0.163
7	0.193
8	0.228
9	0.269
10	0.313
11	0.362

- If you selected a Cobb or Robb Curve in Bird Scale Setting, the Bird Weight screen displays each day's target weight using an industry standard. These data points are read-only.

#### 11.1.2.2.2 Bird Weight Help | Set Definitions

*NOTE Auto method does not feature a help screen.*

Bird Weight	
Bird Weight	
Bird Curve Offset	0.000 

- **Curve Offset:** Enter the factor used to adjust the curve. This amount is added to the "Now" field. Range: -2.000 – 2.000 Kg / -4.40 – 4.41 Lb.

### 11.1.3 SCALE SETTINGS

- General Settings
- Bird Scale
- Feed Bin/Silo Setting

#### 11.1.3.1 General Settings

*NOTE This function does not appear in Version 7.19 and above.*

This menu sets general weighing parameters.

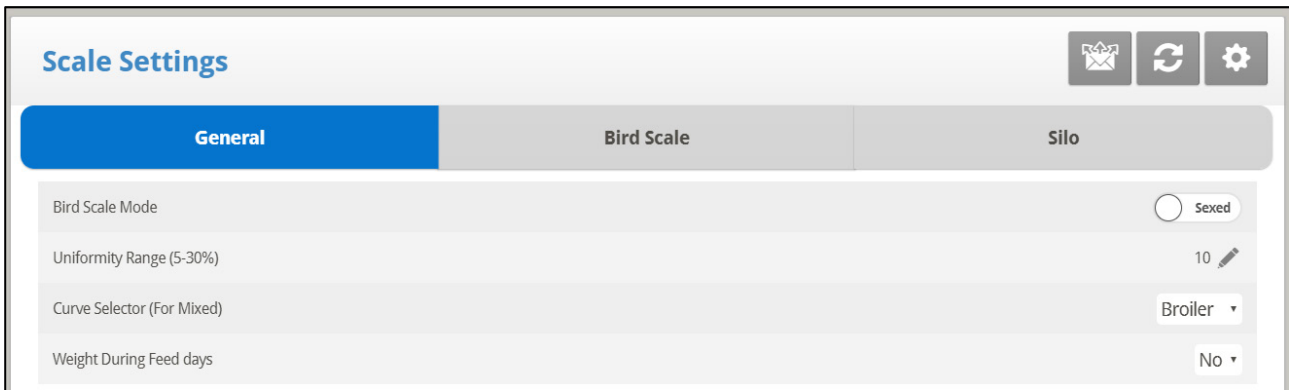

- **Bird Scale Mode:** Select the weighing method:
  - **Sexed:** Considers all birds to be the same sex, 'unisex' as in mixed broilers, or male/female. It computes its own reference weight or acceptable range from the weighed birds.
  - **Mixed:** Considers the flock to be mixed males and females, with the goal of identifying each bird weight as male or female, which is, classifying it according to a pre-programmed pair of expected weight curves.
  - **Male/Female:** Select one of these options when the birds are a single gender.
- **Uniformity Range (5-30%):** Controller classifies bird weights within this percentage of the average as uniform. Default is 10%.
- **Curve Selector (For Mixed):** There are three standard pairs of pre-programmed weight curves. If you use the mixed weighing method, edit the curves to match your expected growth profile (BROILER, TURKEY, or BREEDER).
- **Weigh During Feed Days:** Allow weight data to be recorded on feed days. When set to NO, this data is discarded. Default: No

#### 11.1.3.1.1 General Settings Help | Set Definitions

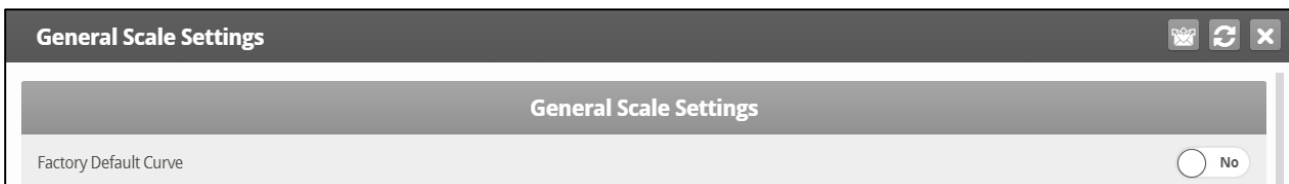

- Define the following parameter:
  - **Factory Default Curve:** Select **YES** to return bird curves to the factory default settings.

#### 11.1.3.2 Bird Scale

➡ Define at least one scale, silo, or feed scale in Scale Layout.

This section describes the Bird Scale Settings for Broiler mode. Refer to Breeder and Layer Mode appendices to view the function for those modes.

- Bird Scale Setting, Version 7.18 and Below
- Bird Scale Setting, Version 7.19

### 11.1.3.2.1 Bird Scale Setting, Version 7.18 and Below

General	Bird Scale	Silo
Start Time	00:00	
End Time	00:00	
Upper Range - (Above reference %)	20	
Lower Range - (Below Reference %)	10	
Reference Weight 1	0.048	
Reference Weight 2	0.048	

#### Bird Scale Setting: Sexed

- **Start Time:** Set the hour you would like the scale to begin weighing
- **End Time:** Set the hour you would like the scale to stop weighing
- **Range – (0-100%):** Band above and below reference weight
- **Reference Weight 1:** Starting out weight for scale 1
- **Reference Weight 2:** Starting out weight for scale 2

#### Bird Scale Setting: Mixed

- **Start Time:** Set the hour you would like the scale to begin weighing
- **End Time:** Set the hour you would like the scale to stop weighing
- **Range – (0-100%):** Band above and below reference weight

*NOTE* Version 7.18 supports four reference weights.

### 11.1.3.3 Bird Scale Setting, Version 7.19

- Bird Scale Setting Screen
- Bird Scale Setting | Set Definitions

#### 11.1.3.3.1 Bird Scale Setting Screen

In this screen, select the algorithm used to calculate the bird curve that appears in Bird Weight, Version 7.19. There are three options:

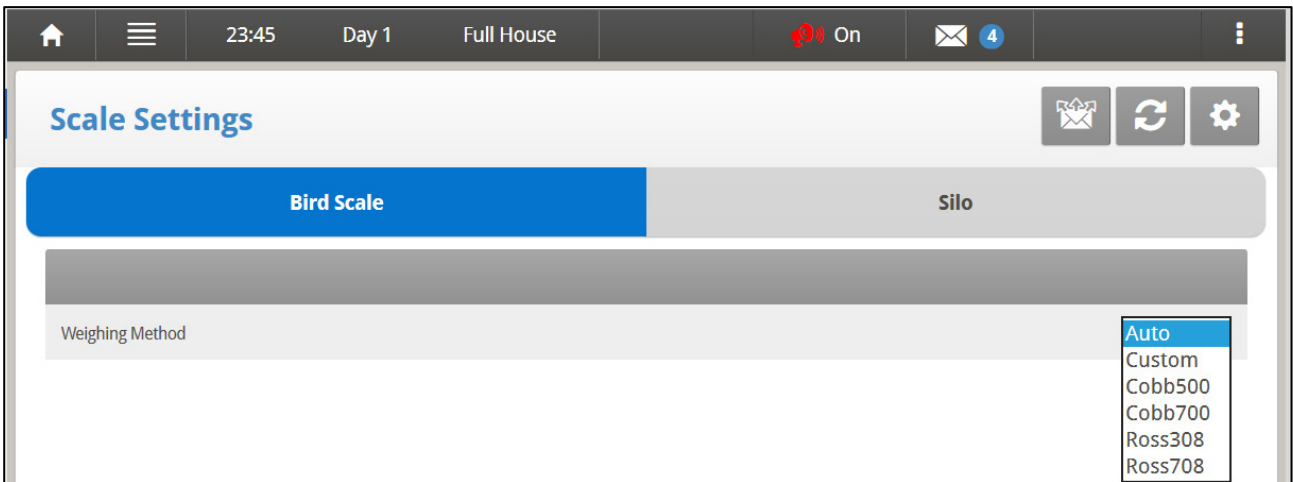

- **Auto:** Set the first target weight. The controller then automatically calculates each day's reference weight.
- **Custom:** The controller provides a weight vs growth day curve, which the user can edit as required.
- **Factory Default Curve:** The controller loads an industry standard bird curve. This curve cannot be edited.
- If required, click  to set the help parameters.

#### 11.1.3.3.2 Bird Scale Setting | Set Definitions

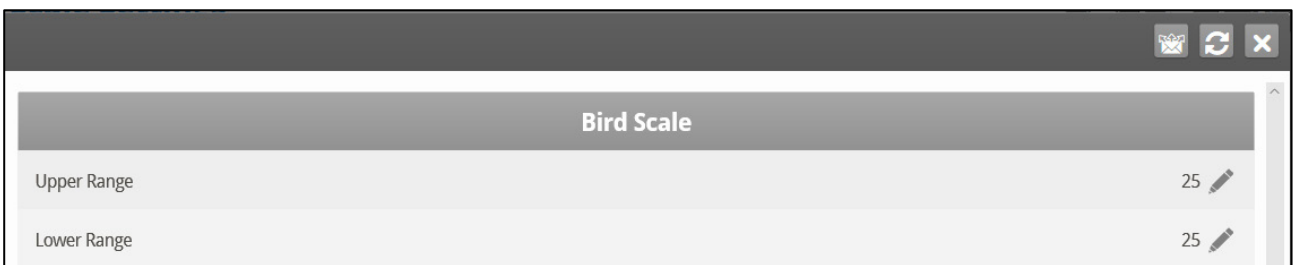

- The upper/lower range parameters define the range of weights that are recorded. The weights of birds that exceed differ from the bird curve by these amounts are discarded.

#### 11.1.3.4 Feed Bin/Silo Setting

These settings help you monitor your silo through weighing. There are two events that take place, emptying (feeding) and filling (loading).

**NOTE** Feed bins and silos must be defined in [Scale Layout](#) for the following parameters to be functional.

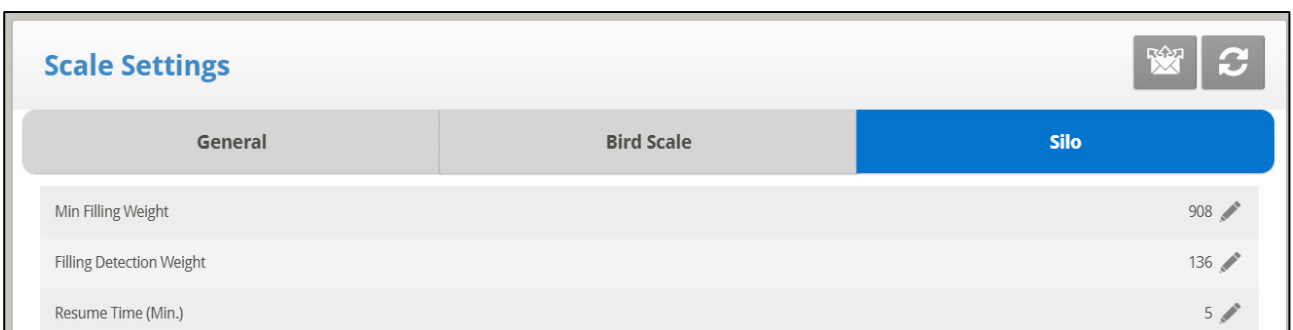

- **Minimum Filling Weight:** Define weight required to be filled during loading to be recorded in History ([Feed Consumption History](#)); History ([Events Log History](#)). (Default: 2000 Kg).
- **Filling Detection Weight:** Define the weight you want your controller to detect a filling to stop augers. (Default: 300 Kg).
- **Resume Time (minute):** Once loading is completed, define the time you want your controller to count down for the augers to resume normal operation (Default: 5 min.).

The following is a typical scenario:

A loading truck will come to fill the bin or silo. Define the **Filling Detection Weight** to stop the augers from operating during a loading event (default: 300 Kg). Next, a **Minimum Filling Weight** needs to be defined to have the filling event recorded in [Feed Consumption History](#) (default: 2000 Kg). Once the loading of the feed is finished, the timer begins to count down for the augers to resume normal operation (Resume Time, Default: 5 minutes) and for the filling event to be recorded as completed.

## 11.1.4 GENDER BASED WEIGHING

- Enabling Gender Based Weighing
- Measuring Gender-Defined Bird Weights, Auto Curve
- Measuring Gender-Defined Bird Weights, Customized/Industrial Standard Curve

### 11.1.4.1 Enabling Gender Based Weighing

*NOTE Version 7.21 and above supports this version.*

Gender Based Weighing enables setting up separate reference weight curves for male and female birds.

To enable gender-based bird curves:

1. Go to Scale Layout > Help.

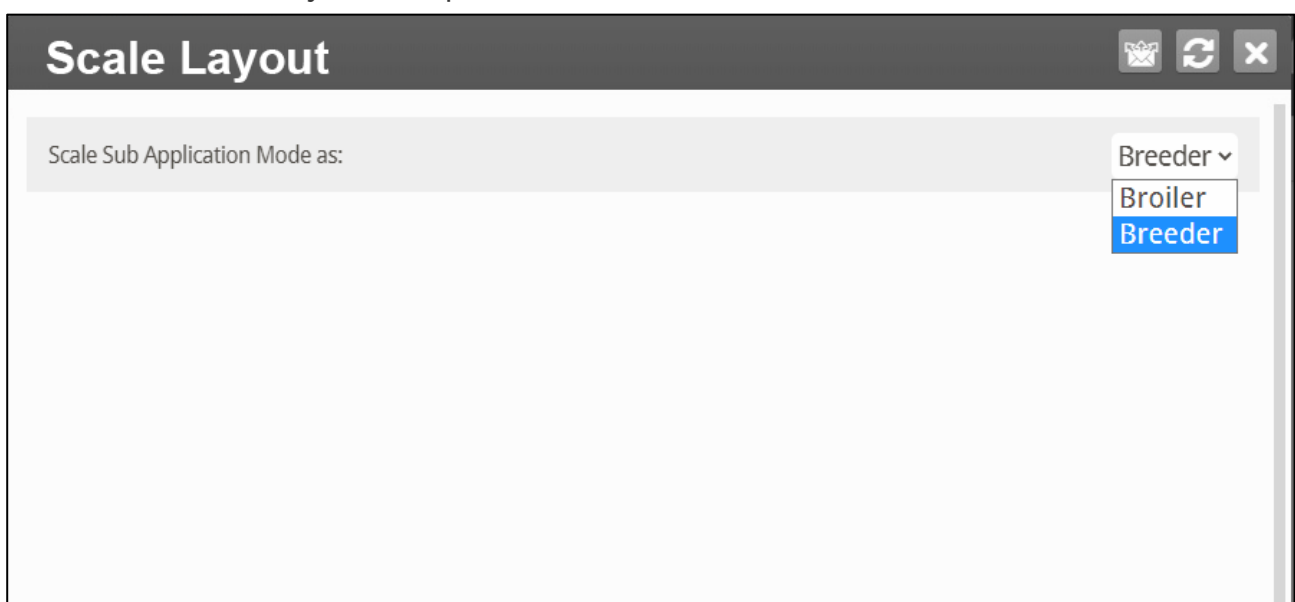

2. Select Breeder.

- Breeder includes two options for setting up the curve: a controller-generated curve and an industrial standard curve.
  - Measuring Gender-Defined Bird Weights, Auto Curve
  - Measuring Gender-Defined Bird Weights, Customized/Industrial Standard Curve
- The Broiler option enables a single weight curve. Continue defining the curve as detailed in Bird Scale Setting, Version 7.19 and Bird Weight, Version 7.19.

### 11.1.4.2 Measuring Gender-Defined Bird Weights, Auto Curve

1. Go to Scale Settings > Bird Scale.

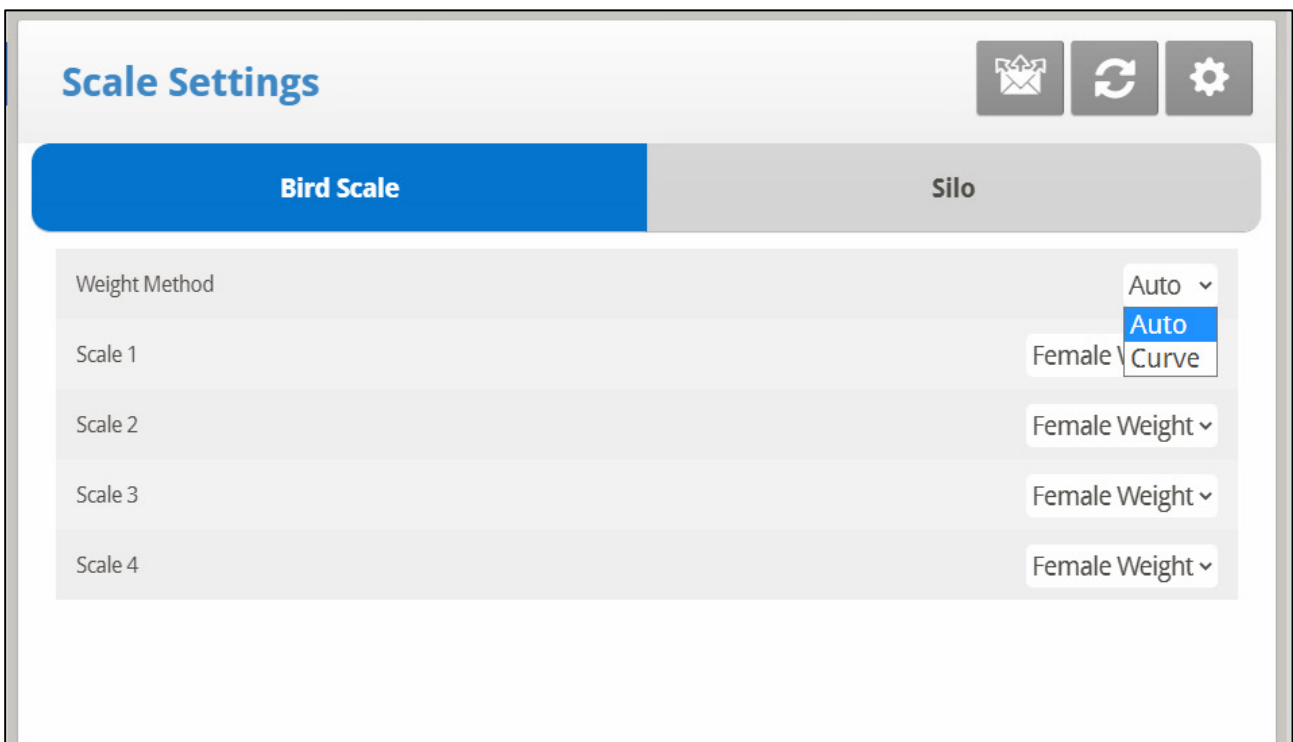

2. In Weighing Method, select Auto.

3. Go to Scale Setting > Bird Scale > Help. Define the parameters (option).

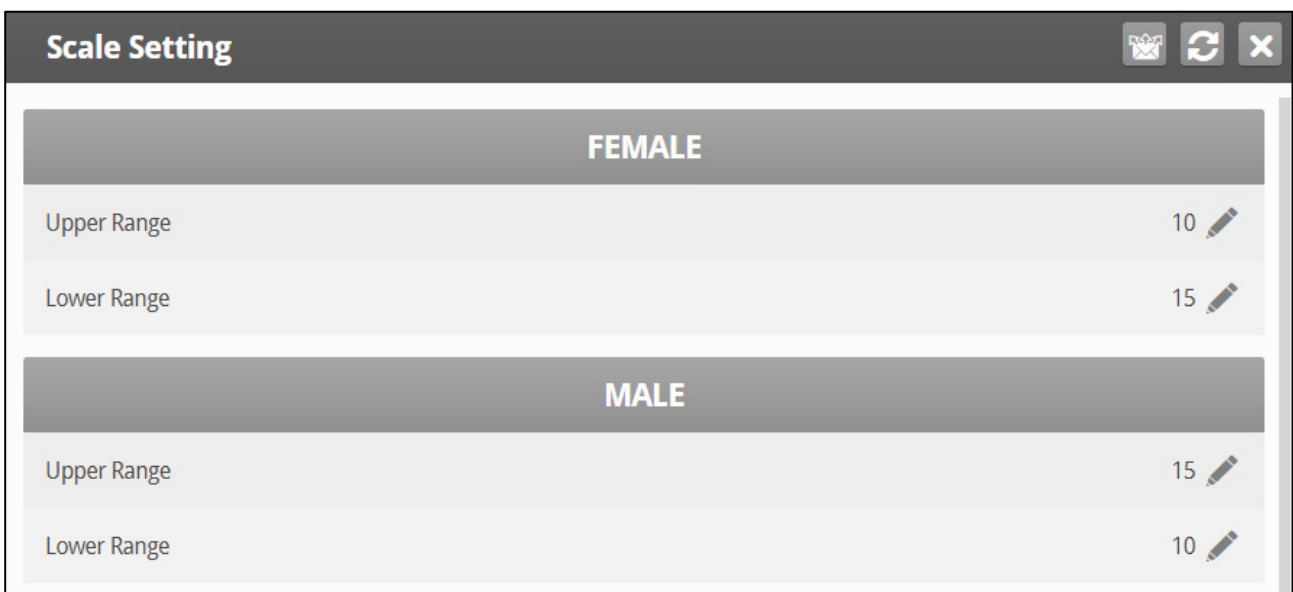

- Male/Female: The upper/lower range parameters defines the range of weights that are recorded. The weights of birds that exceed differ from the bird curve by these amounts are discarded. Note that t the default range of the female and male bird are reversed.

4. Go to Scale > Bird Weight.

Description	Value
Current Female Weight	0.042
Current Male Weight	0.042

5. The Bird Weight screen displays the target weight for the current growth day for each gender. Edit the weight as required.

### 11.1.4.3 Measuring Gender-Defined Bird Weights, Customized/Industrial Standard Curve

1. Go to Scale Setting> Bird Scale Setting.

Scale Settings	
Bird Scale	
Silo	
Weight Method	Auto ▾
Scale 1	Female ▾ Auto Curve
Scale 2	Female Weight ▾
Scale 3	Female Weight ▾
Scale 4	Female Weight ▾

2. In Weighing Method, select Curve.

3. Go to System > Bird Scale Setting > Help. Define the parameters (option).



FEMALE	
Upper Range	10
Lower Range	15
MALE	
Upper Range	15
Lower Range	10

- Male/Female: The upper/lower range parameters defines the range of weights that are recorded. The weights of birds that exceed differ from the bird curve by these amounts are discarded. Note that the default range of the female and male bird are reversed.

4. Go to System > Bird Weight > Help.

FEMALE	
Bird Curve Offset	0.000
Select Curve	Custom
MALE	
Bird Curve Offset	0.000
Select Curve	Custom

5. Define the parameters:

- Bird Curve Offset: Enter the factor used to adjust the weight curve. This amount is added to the curve. Range: -4.40 to +4.41 Kg/Lb.
- Select Curve:
  - Custom: the Bird Weight screen displays a generic curve for each day's target weight. You can edit the weight as required.
  - Factory default curve: The Bird Weight screen displays each day's target weight using an industry standard. These data points are read-only. Note that there are different curves for female or male birds.

6. Go to Scale > Bird Weight.

Day	Female	Male
0	0.042	0.042
7	0.160	0.150
14	0.280	0.340
21	0.400	0.525
28	0.520	0.690
35	0.620	0.830
42	0.720	0.960
49	0.820	1.090
56	0.920	1.220

- The Bird Weight screen displays the target weight for the current growth day for each gender.
  - If you selected Custom in Help, edit the fields as required.
  - If you selected an industrial standard, all fields are read-only.
- Note: If you select Custom, the controller saves all changes that you make to the fields. Meaning that after configuring a customized curve, you can go to the Help, select an industrial curve, and then go back and select Custom. The curve that you defined will reappear.

### 11.1.5 SILO / AUGER LAYOUT VERSION 7.17 AND BELOW

This menu maps augers to a specific silo. Map up to four augers to four silos (one each).

- ➡ In System > [Relay Layout](#), define relay(s) as an auger(s). Augers cannot be mapped until a relay is defined as an auger.

Silo	Auger	Device No
Silo 1	<input checked="" type="radio"/> Auger	2
Silo 2	<input checked="" type="radio"/> Auger	1
Silo 3	<input checked="" type="radio"/> Auger	3
Silo 4	<input type="radio"/> None	—

- On the screen, define each device.

*NOTE* Define the silo channel in [Scale Layout](#).

*NOTE* Define the feeding schedule in [Water & Feed](#).

Use Scale Layout to define the scales or silos connected to the controller.

**NOTE** Versions 7.17 and below do not support a scale card. An RSU-2 unit must be connected to the controller for these screens to appear.

Use Scale Layout to define the scales or silos connected to the controller. Define the weighing device attached to each channel of the scale option card.

Scale Layout		
Channel	Function	No.
Card 1 Main Slot 1		
1	Silo	1
2	Silo	2
Card 2 Main Slot 2		
3	Scale	1
4	Scale	2

### 11.1.6 BIRD WEIGHT HISTORY, VERSION 7.18 AND BELOW

- In Version 7.17 and below, the unit records the data of up to two-bird scales; if you have more than one scale-1, data is combined.
- In Version 7.18, the controller records up to four scales.

Common							Scale		
Day	Weight	Daily Gain	No. Of Weights	Std. Dev.	Uniformity	C.V.	Weight	Daily Gain	No. Of Weights
23	1.118	0.087	4,861	0.082	83	7	1.127	0.092	2,293
24	1.204	0.086	4,789	0.089	83	7	1.202	0.075	2,245
25	1.268	0.064	3,862	0.094	82	7	1.281	0.079	1,891
26	1.310	0.042	2,677	0.098	82	7	1.319	0.038	1,276
27	1.395	0.085	2,611	0.109	78	7	1.406	0.087	1,229
28	1.478	0.083	2,242	0.113	80	7	1.484	0.078	998
29	1.562	0.084	1,882	0.118	81	7	1.568	0.084	786
30	1.648	0.086	1,768	0.126	79	7	1.634	0.066	767
31	1.700	0.052	1,471	0.126	84	7	1.674	0.040	709
32	1.781	0.081	1,357	0.134	81	7	1.739	0.065	596
33	1.843	0.062	452	0.140	81	7	1.811	0.072	204

- If you select **SEXED** weighing, the history includes average data for the combined scales, and on the next screens separate data for each scale.
- If you select **MIXED** weighing, the history includes average data for all birds, and separate male and female data for Scale 1 and for Scale 2.
  - Use the arrow keys to scroll to the separated scale data, or up and down for data that is off screen.

- The average and the number of weights are the usual definition. The Standard Deviation is the usual biased estimator (see a suitable textbook on statistical measurements). The Uniformity is the industry standard 10% uniformity (number of birds per 100 within 10% of the average weight), and the Coefficient of Variation or C.V. is the normalized standard deviation (standard deviation divided by average times 100 %).

## 11.2 Scale Test, Version 7.17 and Below

This section is a real-time table to show the statuses of all scales connected to the controller. Make sure that all statuses are O.K. If any of them show a different status, the scale is not installed properly. Unused positions can also show O.K.

1. In *Scale > Scale Layout* (refer to page 136), select the required scale types.
2. In *Scale > Test*, test the scales as required.

TEST				
	- 1 -	- 2 -	- 3 -	- 4 -
Type	Scale-1	Scale 2	Scale 3	Scale 4
A/D	2024	2010	1891	1893
Weight	0.222	35.768	0.000	0.000
Status	O.K.	O.K.	O.K.	O.K.

## 11.3 Vent & Curtain Levels Help | Set Definitions Version, 7.18 or Below

Vent & Curtain Levels - Settings			
<b>Curtains</b>			
1st Day For 2nd Vent To Operate	1	1st Level For 2nd Vent To Operate	1
<b>Attic</b>			
Min Attic Temperature To Operate	1.7	Attic Operate Until Level	0
Operate From Time	00:00	Operate To Time	00:00
Max Temperature To Disable Attic	37.8		

- Define:

### Curtains

- **Stop Fans, Curtain Move (total %):** Commands controller to stop fans during curtain movements when total of all curtains is less than the total percent set in this parameter. For example, 3 curtains at 40% each total 120% for this parameter. Default: 30%
- **1st Day for 2nd Vent to Operate:** Set the day the second vent begins operating. Default: 1

*NOTE You can set negative days.*

- **1st Level for 2nd Vent to Operate:** Set the level the second vent begins operating. Default: 1

## Attic

- **Minimum Attic Temperature To Operate:** Set the minimum temperature to activate the Attic operation.
- **Attic Operate Until Level:** Set the highest level for attic operation.
- **Operate From/To Time:** Set the time frame for attic operation.

*NOTE If one of the above options is relevant, the Attic is enabled.*

- **Maximum Temperature to Disable Attic:** Set the maximum attic temperature to stop using attic ventilation. This setting can prevent the heating effect in the growing space being too high resulting in overheating.

### 11.4 Breeder Nest Function, Version 7.18 and Below

1. In *System > Relay Layout* designate up to four relays (each) as Nest Open and Nest Close valves.

Relay Layout <span style="float: right;">📄 🔄</span>				
Relay No.	Device	No.	N.C.	
↳ Card 4 Main Slot 4				
31	Nest Open ▼	2	<input type="checkbox"/>	
32	Nest Close ▼	2	<input type="checkbox"/>	
33	Nest Open ▼	3	<input type="checkbox"/>	
34	Nest Close ▼	3	<input type="checkbox"/>	
35	Nest Open ▼	4	<input type="checkbox"/>	
36	Nest Close ▼	4	<input type="checkbox"/>	
37	None ▼	0	<input type="checkbox"/>	
38	None ▼	0	<input type="checkbox"/>	
39	None ▼	0	<input type="checkbox"/>	
40	None ▼	0	<input type="checkbox"/>	

2. In *Control > Nest*, define the parameters:

Nests <span style="float: right;">📄 📧 🔄</span>				
Number	Open		Close	
	Time	Duration (sec)	Time	Duration (sec)
1	07:00	300	09:00	300
2	10:00	300	12:00	300
3	13:00	300	15:00	0
4	16:00	300	18:00	300

- **Open Time:** The time each Nest lines' doors open.
- **Duration:** The amount of time required for the Nests to open.
- **Close Time:** The time each Nest lines' doors close.
- **Duration:** The amount of time required for the Nests to close.

# 12 Warranty

## Warranty and technical assistance

Munters products are designed and built to provide reliable and satisfactory performance but cannot be guaranteed free of faults; although they are reliable products they can develop unforeseeable defects and the user must take this into account and arrange adequate emergency or alarm systems if failure to operate could cause damage to the articles for which the Munters plant was required: if this is not done, the user is fully responsible for the damage which they could suffer.

Munters extends this limited warranty to the first purchaser and guarantees its products to be free from defects originating in manufacture or materials for one year from the date of delivery, provided that suitable transport, storage, installation and maintenance terms are complied with. The warranty does not apply if the products have been repaired without express authorisation from Munters, or repaired in such a way that, in Munters' judgement, their performance and reliability have been impaired, or incorrectly installed, or subjected to improper use. The user accepts total responsibility for incorrect use of the products.

The warranty on products from outside suppliers fitted to Platinum Touch or One, (for example cables, weights, etc.) is limited to the conditions stated by the supplier: all claims must be made in writing within eight days of the discovery of the defect and within 12 months of the delivery of the defective product. Munters has thirty days from the date of receipt in which to take action, and has the right to examine the product at the customer's premises or at its own plant (carriage cost to be borne by the customer).

Munters at its sole discretion has the option of replacing or repairing, free of charge, products which it considers defective, and will arrange for their despatch back to the customer carriage paid. In the case of faulty parts of small commercial value which are widely available (such as bolts, etc.) for urgent despatch, where the cost of carriage would exceed the value of the parts, Munters may authorise the customer exclusively to purchase the replacement parts locally; Munters will reimburse the value of the product at its cost price.

Munters will not be liable for costs incurred in demounting the defective part, or the time required to travel to site and the associated travel costs. No agent, employee or dealer is authorised to give any further guarantees or to accept any other liability on Munters' behalf in connection with other Munters products, except in writing with the signature of one of the Company's Managers.

***WARNING: In the interests of improving the quality of its products and services, Munters reserves the right at any time and without prior notice to alter the specifications in this manual.***

The liability of the manufacturer Munters ceases in the event of:

- dismantling the safety devices;
- use of unauthorised materials;

- inadequate maintenance;
- use of non-original spare parts and accessories.

Barring specific contractual terms, the following are directly at the user's expense:

- preparing installation sites;
- providing an electricity supply (including the protective equipotential bonding (PE) conductor, in accordance with CEI EN 60204-1, paragraph 8.2), for correctly connecting the equipment to the mains electricity supply;
- providing ancillary services appropriate to the requirements of the plant on the basis of the information supplied with regard to installation;
- tools and consumables required for fitting and installation;
- lubricants necessary for commissioning and maintenance.

It is mandatory to purchase and use only original spare parts or those recommended by the manufacturer.

Dismantling and assembly must be performed by qualified technicians and according to the manufacturer's instructions.

The use of non-original spare parts or incorrect assembly exonerates the manufacturer from all liability.

Requests for technical assistance and spare parts can be made directly to the nearest [Munters office](#).



g/MIS/UMGB-2444-03/17 Rev 2.1