

# Installation Manual

## Green Field ECO



# Green Field ECO Controller

Irrigation Controller

Ag/MIS/UmEN-2735-05/19 Rev 1.7  
P/N: 116785



# Green Field ECO Controller

## Installation Manual

Rev 1.7, 01/2024

This manual for use and maintenance is an integral part of the apparatus together with the attached technical documentation.

This document is destined for the user of the apparatus: it may not be reproduced in whole or in part, committed to computer memory as a file or delivered to third parties without the prior authorization of the assembler of the system.

Munters reserves the right to effect modifications to the apparatus in accordance with technical and legal developments.

# Table of Contents

<i>chapter</i>		<i>page</i>
<b>1</b>	<b>INTRODUCTION .....</b>	<b>7</b>
1.1	Disclaimer.....	7
1.2	Introduction .....	7
1.3	Notes .....	7
<b>2</b>	<b>GENERAL INSTRUCTIONS.....</b>	<b>8</b>
2.1	Basic Requirements for On-Site Preparation .....	8
2.2	Frequency Inverters .....	8
2.3	General Dimensions .....	9
<b>3</b>	<b>POWER SUPPLY WIRING .....</b>	<b>10</b>
3.1	Main Power Wiring.....	10
3.2	Electrical Test .....	12
3.3	Firmware Upgrade.....	13
3.3.1	Preliminary Information.....	14
3.3.2	Firmware – SD Card Compatibility .....	14
3.3.3	Preparing the SD Card.....	15
3.3.4	Accessing the Application.....	15
<b>4</b>	<b>ELECTRICAL INSTALLATION.....</b>	<b>17</b>
4.1	Input/Output Layout.....	17
4.2	Output Terminals .....	18
4.2.1	Output Terminal Wiring.....	18
4.2.2	Example of Output Wiring .....	18
4.3	Input Terminals.....	19
4.3.1	Input Terminal Wiring.....	19
4.3.2	Digital Input Examples .....	19
4.4	PC and Inter-Controller Communication .....	22
4.4.1	Card Installation.....	22
4.4.2	Wiring and Controller Setup .....	23
<b>5</b>	<b>CONTROLLER SETUP.....</b>	<b>25</b>
5.1	Start-Up .....	25
5.2	Device Layout .....	25
5.3	Device List .....	26
5.4	Digital Input .....	27
5.5	Analog Input.....	27

5.6	Hot Keys and Status Screens .....	29
<b>6</b>	<b>CONTROLLER TEST PROCEDURE.....</b>	<b>32</b>
6.1	Relays .....	32
6.2	Digital Input .....	33
6.3	Analog Input .....	33
6.4	Temperature .....	34
6.5	Humidity.....	34
<b>7</b>	<b>SYSTEM CONFIGURATION PROCEDURE .....</b>	<b>35</b>
7.1	Device Delay Configuration .....	35
7.1.1	Example of Device Startup & Shutdown Order .....	36
7.1.2	Example of Stagger Valve Delay – Multiple Shifts.....	37
7.2	Pump Station Configuration.....	38
7.3	Valve Configuration .....	39
7.4	Valve Flow Rate .....	40
7.5	Water Meter .....	40
7.6	Dosing Channel Configuration .....	42
7.7	Dosing Configuration .....	43
7.8	Drainage Configuration.....	44
7.9	EC/pH Configuration .....	45
7.10	Cooling Configuration.....	45
7.11	Misting Configuration .....	45
7.12	History Resolution.....	46
7.13	System Nutrigation™ Check .....	47
7.13.1	Check if EC/pH is on Target.....	47
7.13.2	Water Run Time.....	47
7.13.3	Start/Stop Valve .....	47
<b>8</b>	<b>CONTROLLER ADVANCED SETTINGS .....</b>	<b>49</b>
8.1	Pump Station Configuration.....	49
8.2	Multiple Water Meters .....	50
8.3	Various Dosing Configurations.....	50
8.3.1	Method 1.....	50
8.3.2	Method 2 .....	51
8.3.3	Method 3 .....	51
8.4	Dosing Configuration .....	51
8.4.1	EC/pH Control Step 1 .....	51
8.4.2	EC/pH Control Step 2.....	52
<b>9</b>	<b>PROGRAM MENU .....</b>	<b>53</b>
9.1	Irrigation.....	54
9.1.1	Setting Irrigation that is Longer than 24 Hours .....	58
9.2	Influence Program.....	58

9.2.1	Using the Influences .....	59
9.2.2	Setting the Influences .....	59
9.2.2.1	Radiation Influence on EC.....	59
9.2.2.2	Drainage Influence on Target Radiation Sum.....	60
9.2.2.3	Drain Influence on Minimum Time .....	61
9.2.2.4	VPD Influence on Target EC .....	62
9.2.2.5	Temperature Influence on Target EC.....	63
9.3	Water Run Time.....	64
9.4	Dosing .....	65
9.4.1	Dosing Program .....	65
9.4.2	Dosing Injection Methods.....	66
9.5	Ext. Condition .....	67
9.6	Agitator .....	68
9.7	Selector .....	69
9.8	Filter Flushing.....	69
9.9	Cooling.....	70
9.10	Misting.....	73
9.11	Water Heating .....	74
<b>10</b>	<b>MANUAL OPERATION MENU.....</b>	<b>75</b>
10.1	Irrigation Pause.....	75
10.2	Start/Stop Program .....	76
10.3	Start/Stop Valve.....	76
10.4	Filter Flushing.....	77
<b>11</b>	<b>SETUP MENU.....</b>	<b>78</b>
11.1	Time and Date.....	78
11.2	System Setup.....	79
11.3	Temperature Calibration.....	81
11.4	Humidity Calibration .....	81
11.5	EC/pH Calibration .....	82
11.5.1	Calibration of the EC/pH Monitor Transmitter.....	82
11.5.1.1	EC Calibration .....	82
11.5.1.1.1	Auto Set EC (EC factory set).....	82
11.5.1.1.2	EC Soft Calibration .....	83
11.5.1.2	pH Calibration.....	83
11.5.1.2.1	Auto Set pH (pH Factory set) .....	83
11.5.1.2.2	pH Soft Calibration .....	84
11.5.2	EC/pH Transmitter Monitor & Green Field ECO Correlation .....	85
11.6	Sensors Logging .....	86
11.7	Write to Data Plug.....	86
11.8	Read from Gold Data Plug.....	87

<b>12</b>	<b>APPENDIX A: GREEN FIELD ECO PARTS LIST .....</b>	<b>88</b>
	12.1 Green Field ECO Spare Parts List.....	88
	12.2 Green Field ECO for Korea/China (KC) Spare Parts List.....	89
<b>13</b>	<b>APPENDIX B: TROUBLESHOOTING .....</b>	<b>90</b>
	13.1 Controller Display is Off .....	90
	13.2 Output Malfunction.....	92
<b>14</b>	<b>APPENDIX C: REPLACEMENTS AND ADDITIONAL INSTALLATIONS .....</b>	<b>93</b>
	14.1 Power Supply Card.....	93
	14.2 Relay Card .....	94
<b>15</b>	<b>APPENDIX D: SENSOR INSTALLATION AND DEFINITION .....</b>	<b>95</b>
	15.1 EC – pH Sensor Connection.....	95
	15.1.1 EC Sensor Calibration.....	95
	15.1.2 pH Sensor Calibration.....	97
	15.2 Temperature/Humidity Sensor Connection .....	99
	15.2.1 Humidity Sensor Definition .....	99
	15.3 Sensor and Cable Specifications .....	100
<b>16</b>	<b>APPENDIX E: TECHNICAL SPECIFICATIONS .....</b>	<b>101</b>
	16.1 Technical Specifications.....	101
	16.2 Controller Components .....	102
	16.2.1 Keyboard & Display .....	102
	16.2.2 Hardware Components.....	103
	16.2.2.1 Components .....	103
	16.2.2.2 Hardware Layout.....	104
	16.2.3 Power Supply Card.....	106
	16.2.3.1 Option A: 115 or 230 VAC Power Supply Card .....	107
	16.2.3.2 Option B: 115VAC or 230VAC Power Supply Card with External 24VAC Power for Output Devices.....	108
	16.2.3.3 Option C: 12VDC Power Supply Card.....	109
	16.2.4 Input and Output Card.....	110
<b>17</b>	<b>APPENDIX F: MAIN MENU TREE .....</b>	<b>111</b>
<b>18</b>	<b>WARRANTY .....</b>	<b>112</b>

# 1 Introduction

## 1.1 Disclaimer

Munters reserves the right to make alterations to specifications, quantities, dimensions etc. for production or other reasons, subsequent to publication. The information contained herein has been prepared by qualified experts within Munters. While we believe the information is accurate and complete, we make no warranty or representation for any particular purposes. The information is offered in good faith and with the understanding that any use of the units or accessories in breach of the directions and warnings in this document is at the sole discretion and risk of the user.

## 1.2 Introduction

Congratulations on your excellent choice of purchasing a Green Field ECO!

In order to realize the full benefit from this product it is important that it is installed, commissioned and operated correctly. Before installation or using the controller, this manual should be studied carefully. It is also recommended that it is kept safely for future reference. The manual is intended as a reference for installation, commissioning and day-to-day operation of the Munters Controllers.

## 1.3 Notes

Date of release: July 2019

Munters cannot guarantee to inform users about the changes or to distribute new manuals to them.

All rights reserved. No part of this manual may be reproduced in any manner whatsoever without the expressed written permission of Munters. The contents of this manual are subject to change without notice.

# 2 General Instructions

- Installation should be performed by authorized technicians only.
- Verify that field components are working properly.
- Apply all safety regulations.
- Do not apply force or pressure on components during the installation procedure.
- Refer to your supervisor if problems occur during installation procedure.

**CAUTION** *This unit must be installed inside, in a location protected from solar radiation and direct rain.*

## 2.1 Basic Requirements for On-Site Preparation

- Verify power source between 115 VAC or 220 VAC  $\pm$  10%
- On the unit is a silver label stating the unit's voltage (110 or 230 VAC). **Verify that your unit supports the voltage supplied in your country.**
- Verify grounding connection  $< 10\Omega$
- Environment temperature between  $-10^{\circ}\text{C} / 14^{\circ}\text{F}$  to  $+60^{\circ}\text{C} / 140^{\circ}\text{F}$
- Verify protection from damaging climate conditions

## 2.2 Frequency Inverters

- Frequency inverters can cause severe electrical and electromagnetic interference. Therefore, when employing a frequency inverter, it is critical that you carefully follow the manufacturer's installation instructions.
- In particular verify:
  - that the cable shielding between the inverter and any motor meets industry standards
  - proper grounding of the inverter's chassis and motor power cable
  - proper grounding of low voltage cable shield wire
  - that the controller and inverter cables are kept in separate conduits or wire bundles



## 2.3 General Dimensions

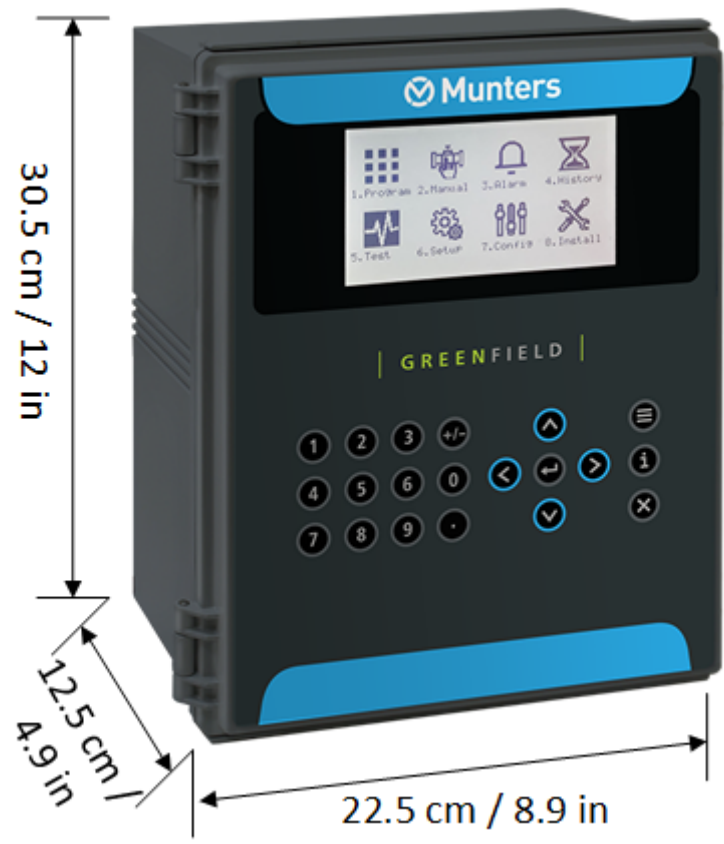

# 3 Power Supply Wiring

- Main Power Wiring
- Electrical Test
- Firmware Upgrade

## 3.1 Main Power Wiring



**CAUTION! SHOCK HAZARD!** The electrical installation should be performed by a qualified electrician only!

**1**  **SWITCH OFF** Main power

Verify grounding connection <math><10\Omega</math>



**2**  **LOOSEN** Gland screw

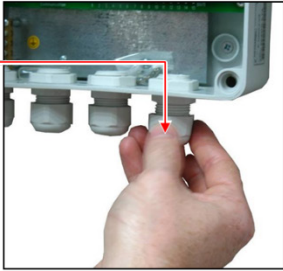

**3**  **INSERT** Feeding cable into Gland cover

USA:  
Green = GND  
White = Common  
Black = Phase

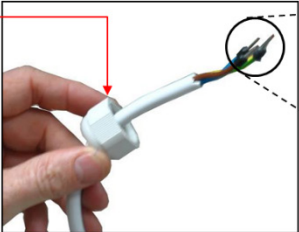

NOTE: Ensure source voltage matches sticker (USA/MEX: 115VAC)



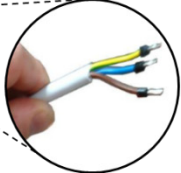

Tri-wires feeding cable  
3\*1.5 mm<sup>2</sup> or  
3\*16 AWG





© Munters AB, 2020

10

**4**  Cable into gland screw

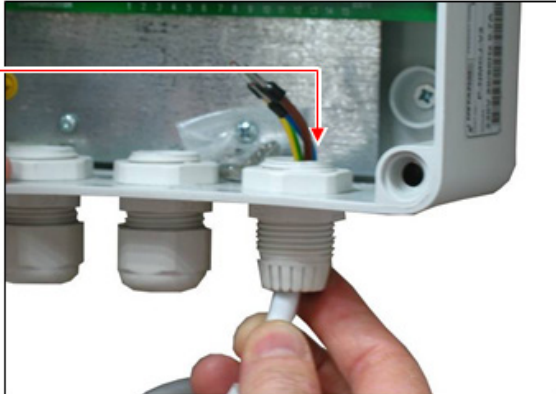
 Cable length to reach the terminal connector location



**5**  Gland cover





**6**  Terminal Connector



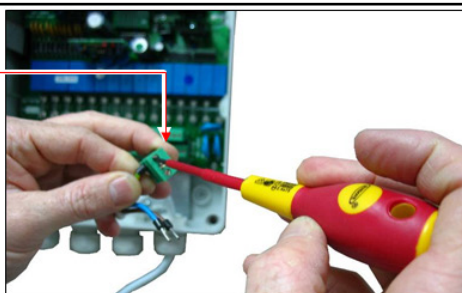

**7**  Screws x3

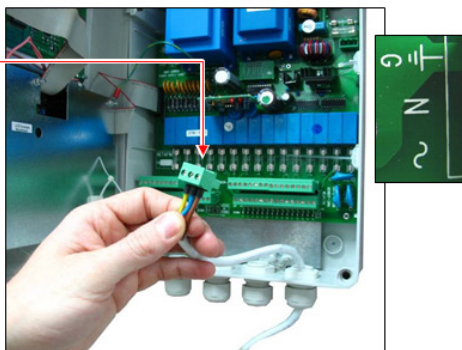

**8**  Wire accordingly:  
~ Phase  
N- Neutral  
G- Ground

 Screws x3

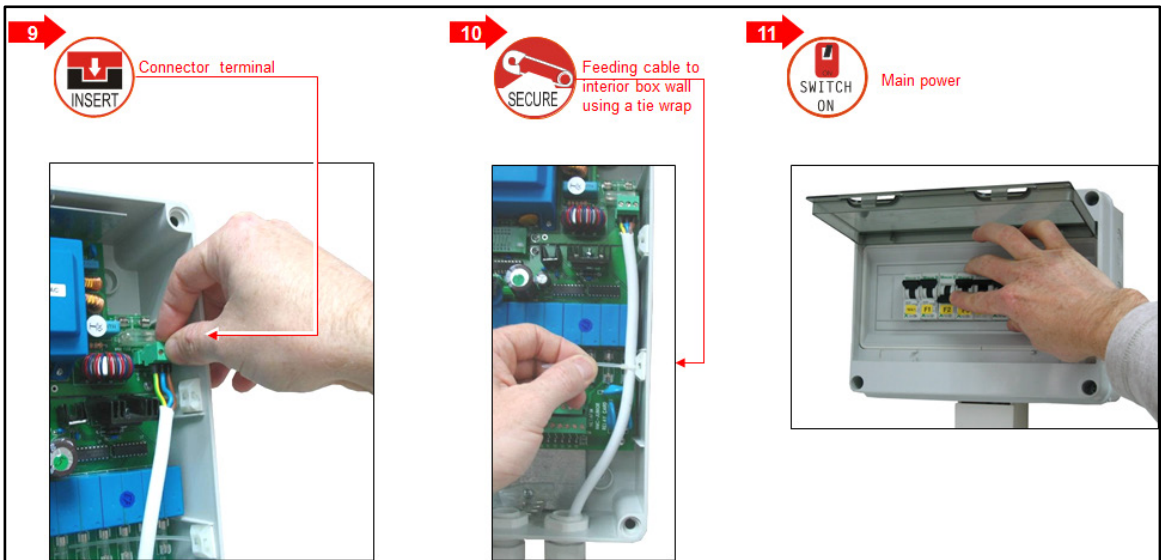

### 3.2 Electrical Test

**CAUTION! SHOCK HAZARD! The electrical installation should be performed by a qualified electrician only!**

**1** **PERFORM** Electrical test with Multimeter



**2** **CHECK**

⇒ Phase to ground  
⇒ Phase to neutral

**ENSURE**

Phase to ground results:  
Option 1- 220VAC± 10 % (EUR, AFR)  
Option 2- 115VAC±10% (USA, MEX)  
Option 3- 240VAC±5% (AUS, NZ)

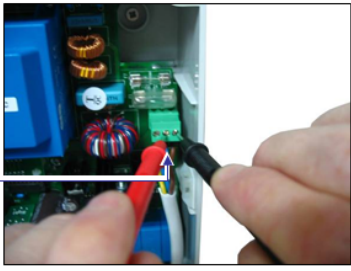
Phase to neutral results:  
Option 1- 220VAC± 10 % (EUR, AFR)  
Option 2- 115VAC±10% (USA, MEX)  
Option 3- 240VAC±5% (AUS, NZ)

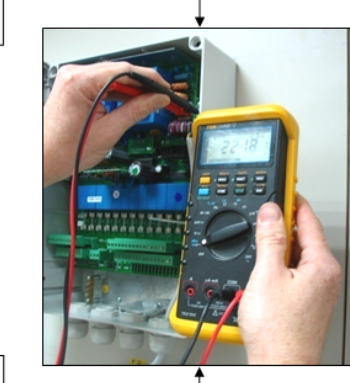

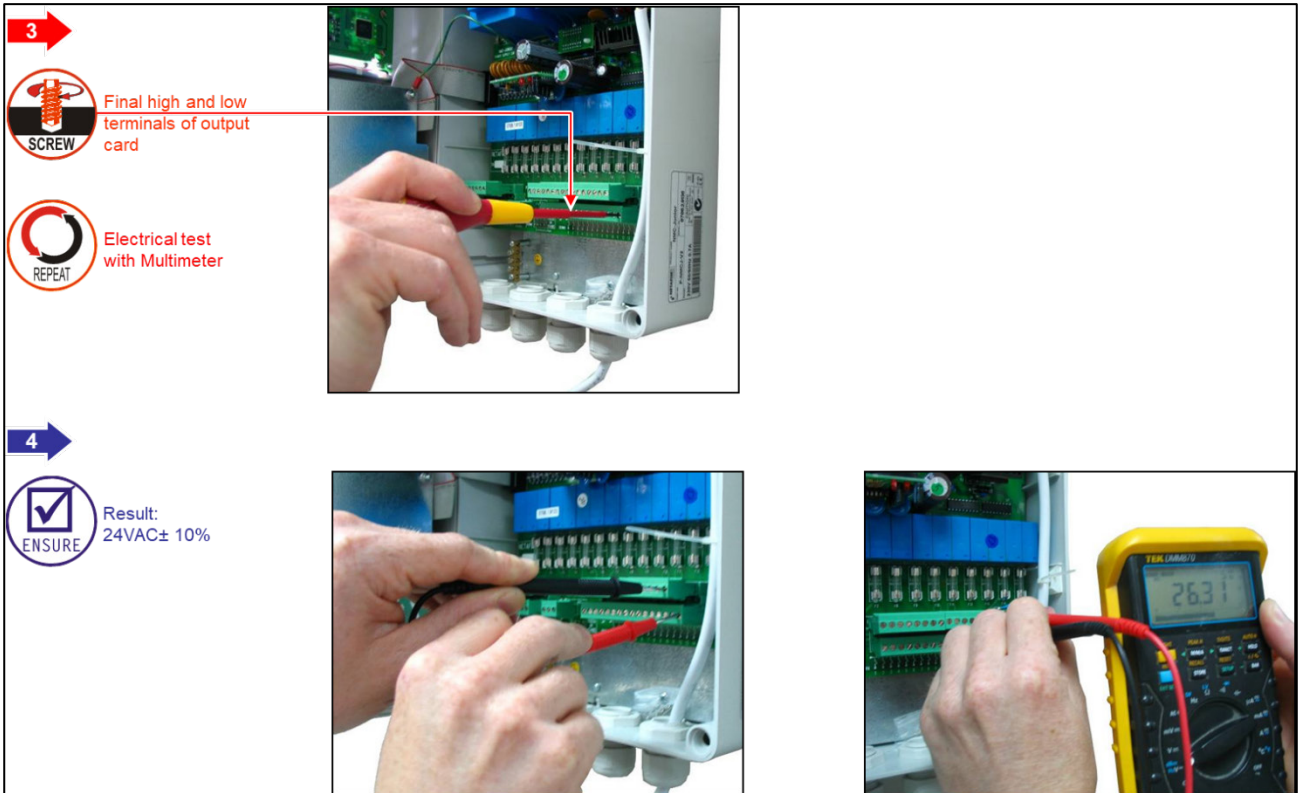
### 3.3 Firmware Upgrade

This section details the software upgrade procedure, starting from determining which SD card is compatible.

The Bootloader application enables updating the system firmware. The application is menu based and simple to use and enables updating the firmware from an SD card. Due to changes made by SD card manufacturers in newer cards, there is a compatibility issue between these cards and the ARM CPU boot section software (the software used when upgrading the controller firmware). The card is found inside the ARM CPU.

Because of this incompatibility, the procedure suspends itself and an error message appears: SD CARD NOT FOUND. (In certain cases, the process can simply suspend itself with no message given.)

**CAUTION** If the upgrade process fails, contact Munters technical support regarding an RMA.

**NOTE** Verify that the card is in place before starting.

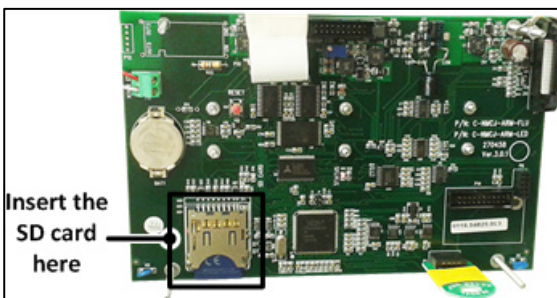

- Green Field ECO supports up to 4 GB SD cards.

### 3.3.1 PRELIMINARY INFORMATION

- Munters strongly recommends having a spare CPU on site, in case the upgrade fails.
- Before upgrading, store the controller’s setting on a data plug (refer to Write to Data Plug).
- After upgrading, upload the controller’s setting from a data plug (refer to Read from Data Plug).
- While upgrading the firmware, a qualified Munters technician:
  - must be on-site.
  - must verify that the process is complete; verification includes checking all accessories connected to the controller.
    - In the event that the controller sends a message regarding incomplete information, the technician must enter the missing information manually and verify that the information is correct while in the field.
- By default, in all sessions the controller returns to **automatic mode**. The technician must verify that there are no manual mode devices in the field.



**CAUTION** Any upgrade that is not performed in accordance with these guidelines could result in unforeseen malfunctions in the field equipment. Munters will not take responsibility for these issues.

### 3.3.2 FIRMWARE – SD CARD COMPATIBILITY

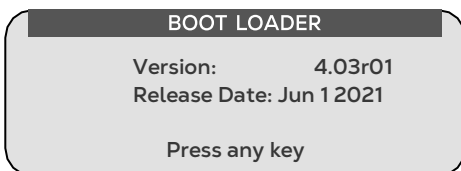
1. On the CPU Card, press the red Reset button.
2. While the CPU is restarting press and hold down the DOWN and LEFT arrows button on the front display panel. The screen displays the Boot Version for a few seconds.



There are three version types. The following table details which SD card must be used with each version.

ARM CPU Card, Software Version 4.03.0 supports “older SD cards” only	
ARM CPU Card, Software Version 4.03.1 supports “newer SD cards” cards only.	

ARM CPU Card, Software Version 4.03.2 supports “newer SD cards” cards only.



- Both “old” and “new” type SD cards have the same PN, but the date code on the bottom right corner differs.
- “New” type SD cards are dated with Year 2020 or later (first 2 digits; see below)



#### Summary

Boot Version type	SD type-Old	SD type-New	Notes
4.03.01 or higher	V	V	
4.03.00 or lower	V	--	

### 3.3.3 PREPARING THE SD CARD

1. Remove the SD card from the ARM CPU and place it in a standard SD card reader.
2. From your computer, paste the firmware (GRFT30809\_A.hex) onto the card (meaning do not place the file in a directory).
3. Place the SD card back in the ARM CPU.

### 3.3.4 ACCESSING THE APPLICATION

**NOTE** Pressing  takes you to the previous menu.

1. Press and hold the Left and Down arrow keys.
2. Turn on the unit.

In the screen that appears, enter the password: **1948**. The following screen appears.

**NOTE** If you enter the wrong password, an error message appears and the program goes to the Main Screen. Repeat the process.

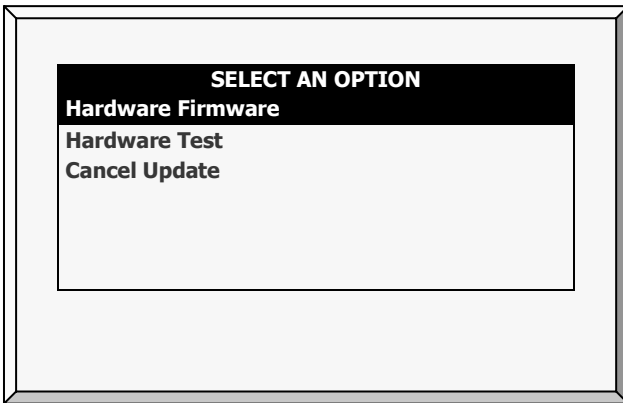

*NOTE Hardware Test is used for quality control only.*

3. Select Hardware Firmware. The following screen appears (example only):

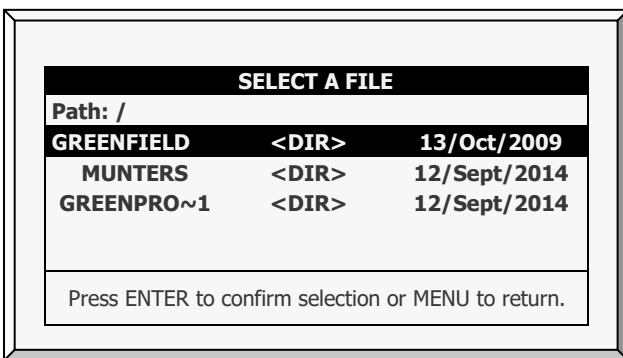

4. Select the required file.

5. Press .

6. A confirmation message appears. Select Yes.

7. Press .

*NOTE Do not turn the unit off during the update! If there is an interruption (for example a power outage), restart the process.*

At the end of the process, the following screen appears (the version numbers are examples only):

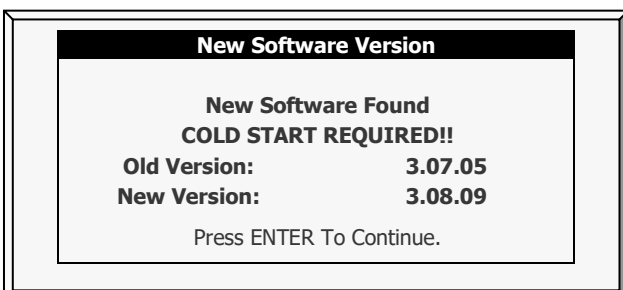

8. Press  and perform a Cold Start.



# 4 Electrical Installation

- Input/Output Layout, page 17
- Output Terminals, page 18
- Input Terminals, page 19
- PC and Inter-Controller Communication, page 22

## 4.1 Input/Output Layout

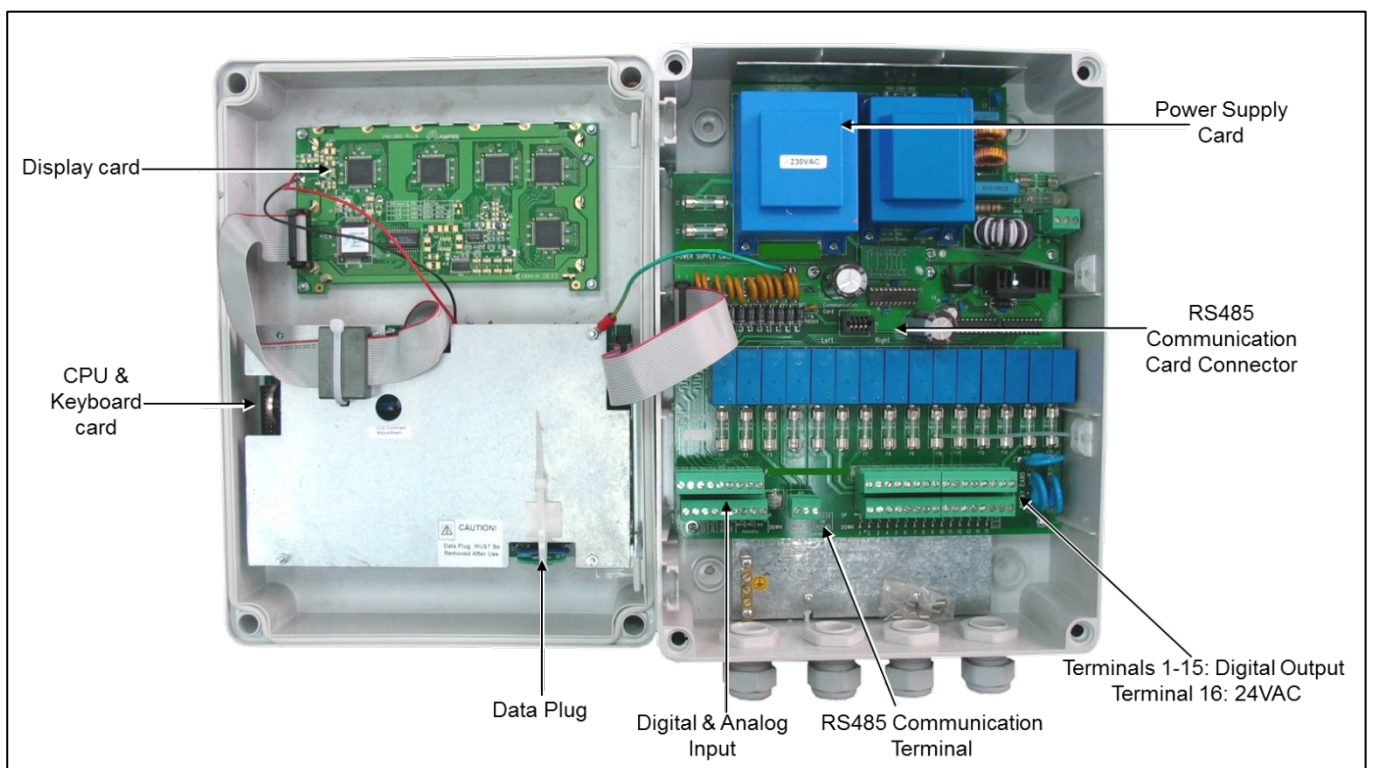

## 4.2 Output Terminals

- Output Terminal Wiring
- Example of Output Wiring

### 4.2.1 OUTPUT TERMINAL WIRING

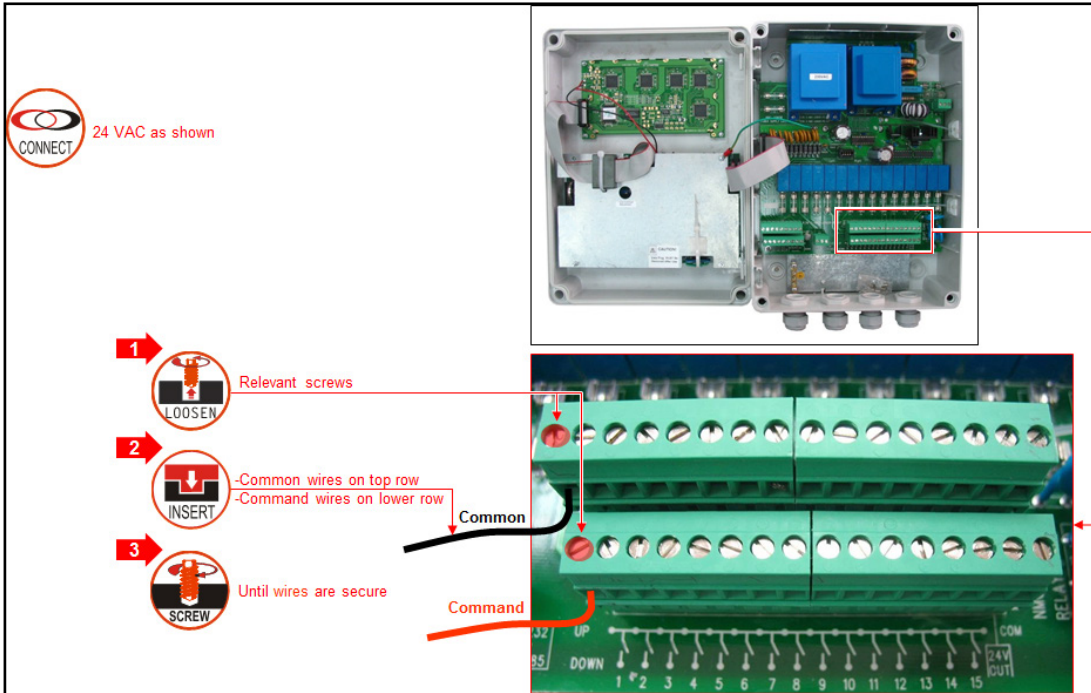

### 4.2.2 EXAMPLE OF OUTPUT WIRING

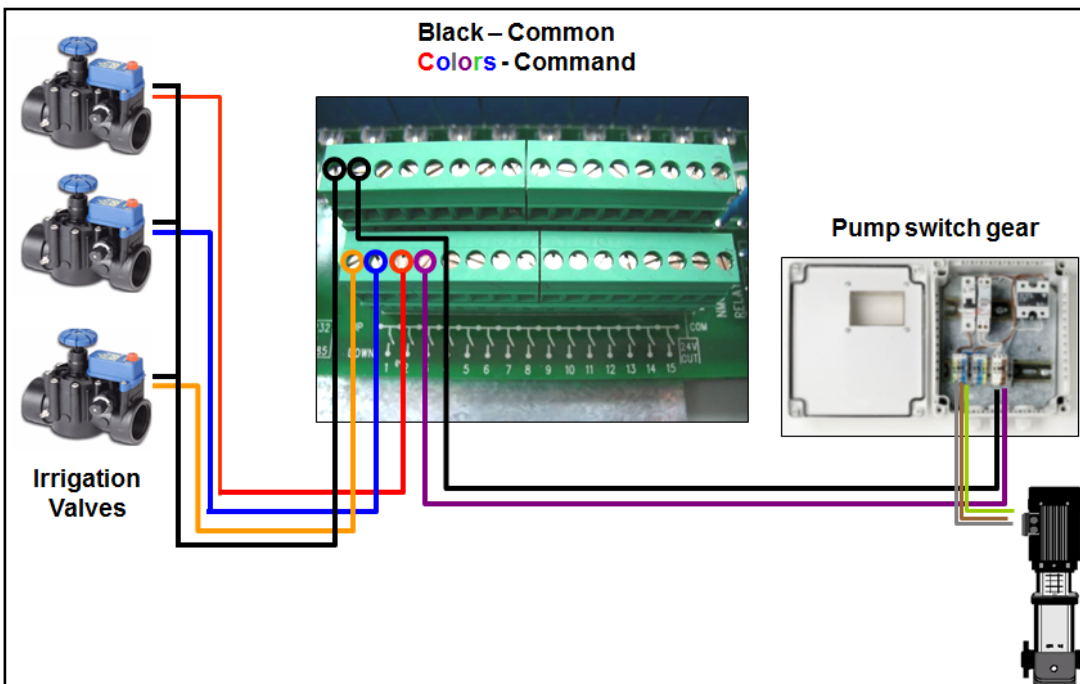

*NOTE Before switching the controller on, the technician should verify that there is no short circuit on each output. (Resistance test)*

## 4.3 Input Terminals

- Input Terminal Wiring
- Digital Input Examples

### 4.3.1 INPUT TERMINAL WIRING

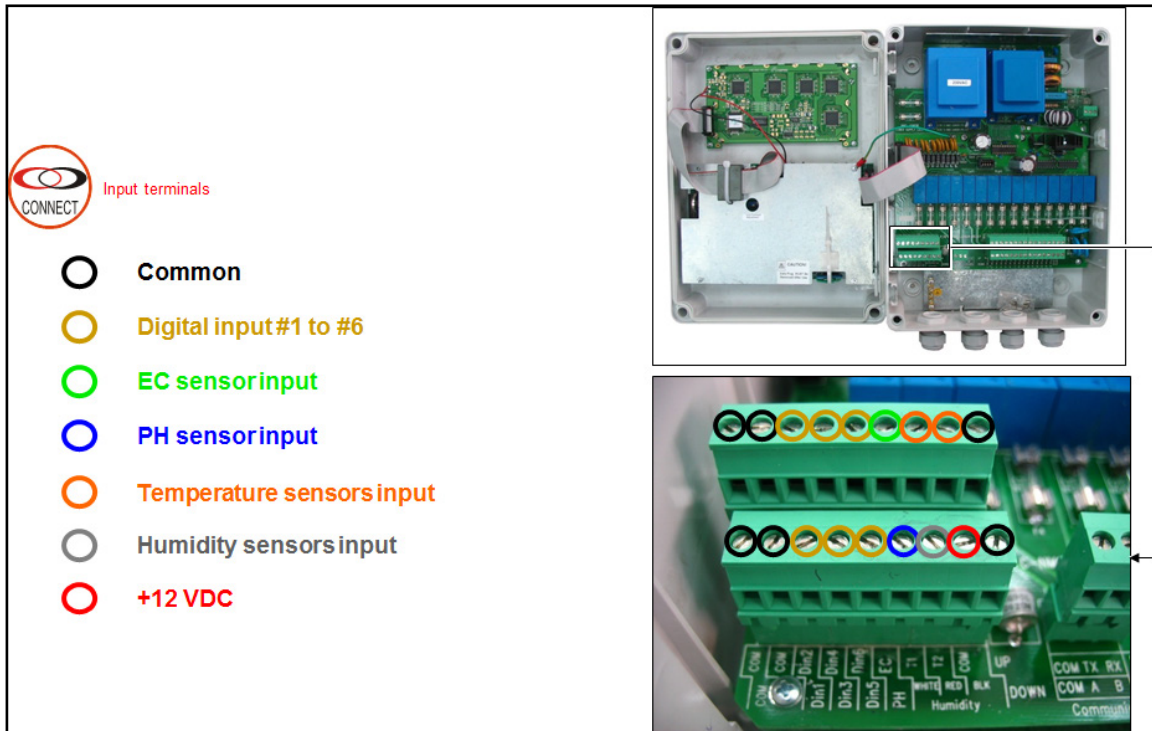

### 4.3.2 DIGITAL INPUT EXAMPLES

- Example A
  - Digital input 1: Water meter, Fertilizer meter
  - Digital input 2: Float switch, Pressure switch

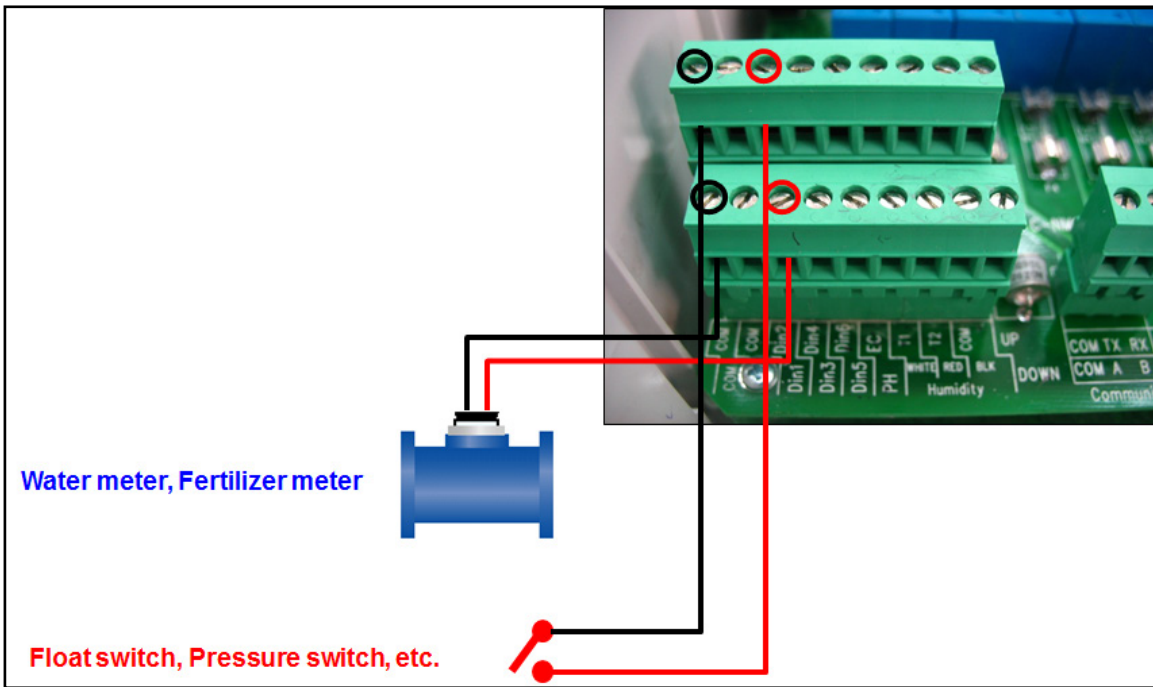

- Digital Input 3: Water Meter with Photo-Diode Output

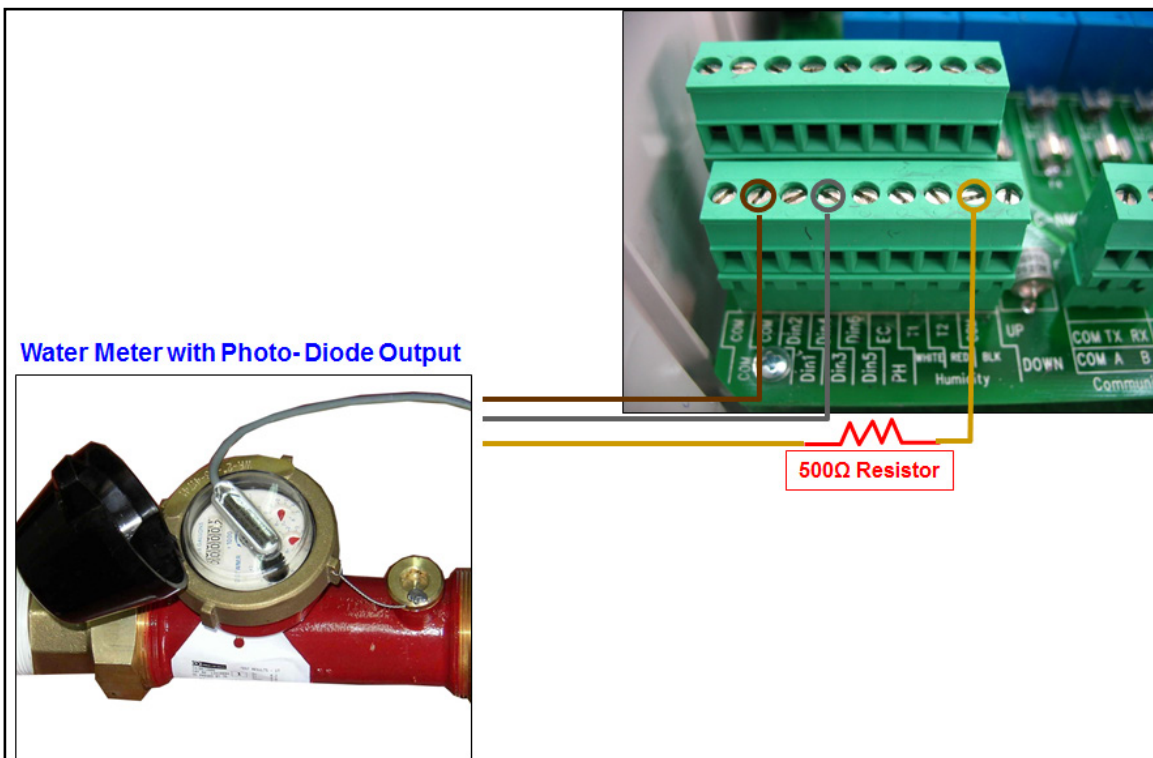

- Example B: EC / pH sensors

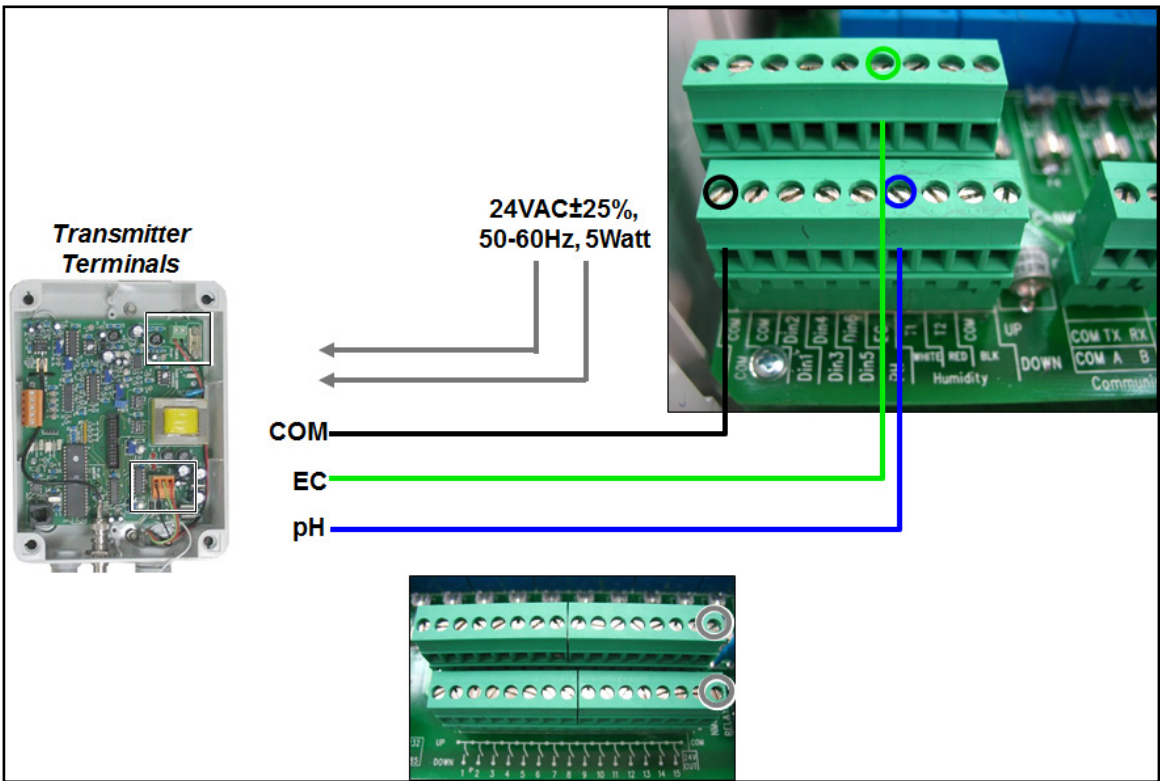

NOTE Can wire EC/pH main power source to 24VAC on the output terminals.

- Example C: Temperature / Humidity Sensors

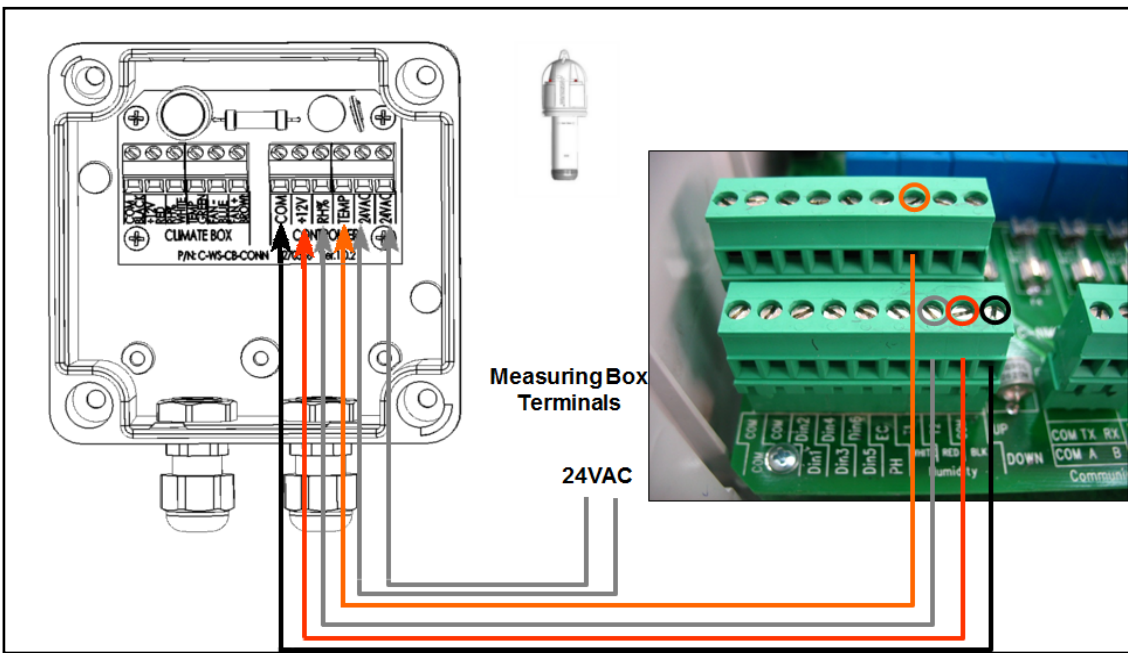

## 4.4 PC and Inter-Controller Communication

- Card Installation
- Wiring and Controller Setup
- Communication Distance and Baud Rate

### 4.4.1 CARD INSTALLATION

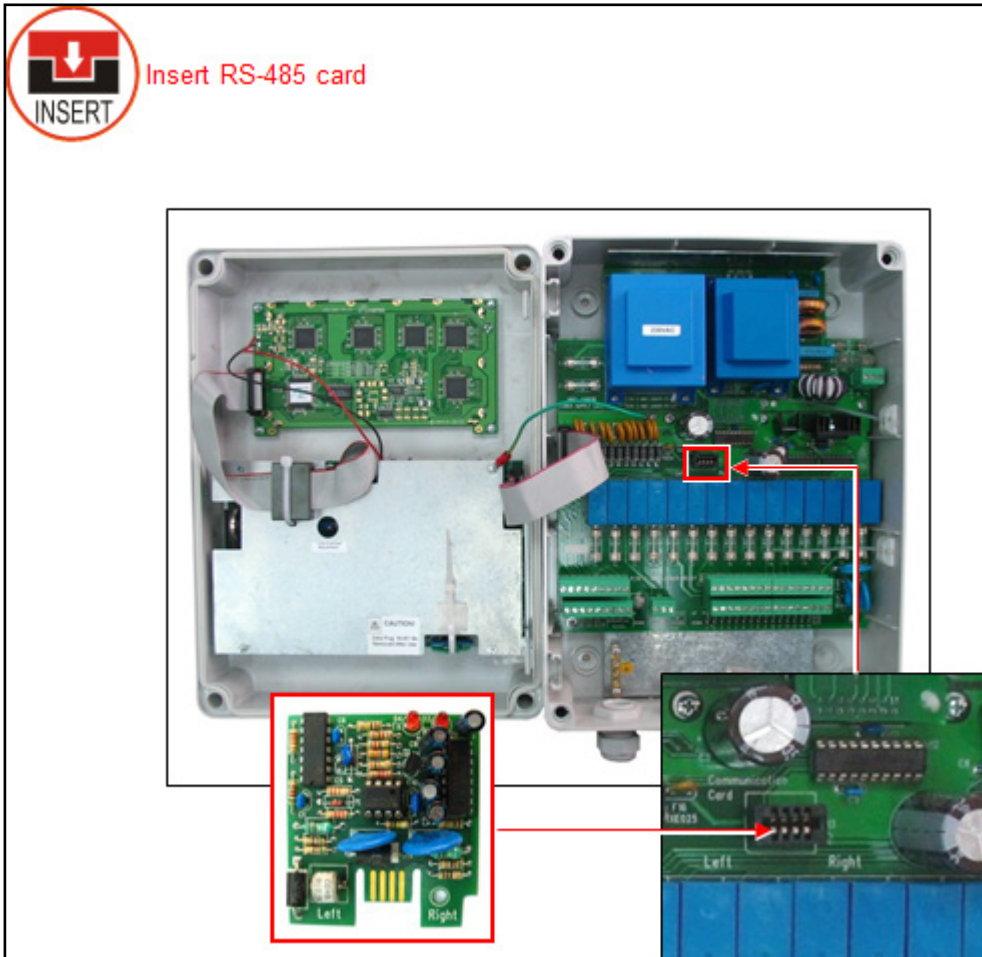

## 4.4.2 WIRING AND CONTROLLER SETUP

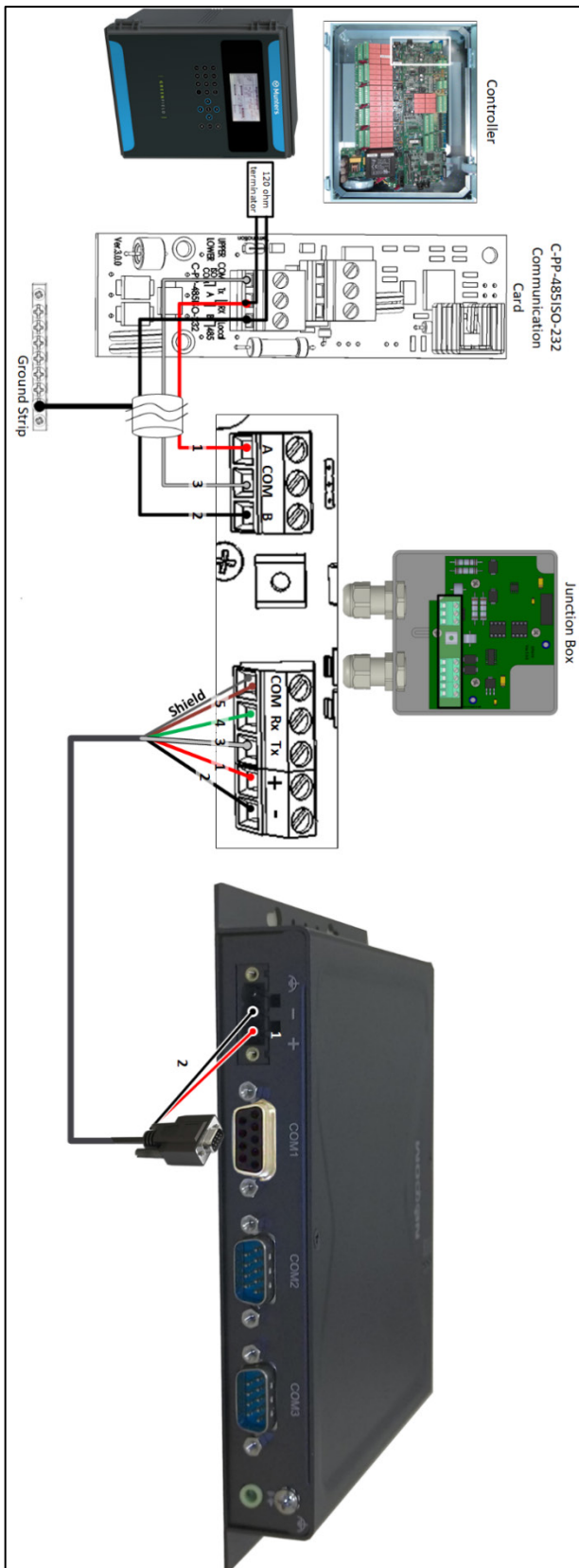

The wiring is detailed in following table:

Number	Color Wire
1	Red
2	Black
3	White
4	Green
5	Brown
COM Port	Shield wire

Figure 1: RS-485 Wiring to Comm-Box

**NOTE** Refer to the Comm-Box Manual on wiring details, how to log-on to the Comm-Box and manage the controller.

#### 4.4.3 COMMUNICATION DISTANCE AND BAUD RATE

Baud Rate	One Controller	10 Controllers
9600 BPS	2000 meter 1.25 mile	1200 meter 0.75 mile
4800 BPS	2500 meter 1.55 mile	1800 meter 1.12 mile
2400 BPS	3000 meters 1.86 mile	2400 meter 1.49 mile

*NOTE Baud rate is dependent on cable length and number of controllers.*



# 5 Controller Setup

- Start-Up
- Device Layout
- Device List
- Digital Input
- Analog Input
- Hot Keys and Status Screens

## 5.1 Start-Up



## 5.2 Device Layout

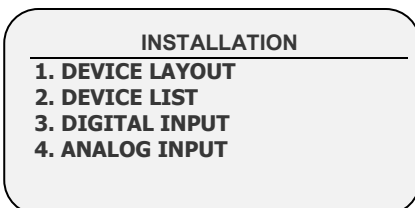



The device layout screen allows you to assign functions to each output (relay).

1. Place the cursor on the Function column, use the arrow keys to reach the



relevant line, and press . A selection list including all available devices will appear.

2. Choose the required device and confirm by pressing . The cursor will move to the No. column.

3. Specify the number of the device in the controller and press  to confirm.

4. If you wish to define several devices of the same type, for example valves 1



to 10, configure the first one and press a few times until you reach the required amount. The Green Field ECO automatically continues with the same device until instructed otherwise, or until reaching the system limitation for that device.

*NOTE* If 'Radio' is selected in table 6.2, the screen contains at least 64 outputs.

DEVICE LAYOUT		
Relay	Function	No
1	Valve	99
2	Valve	00
3	Valve	01
4	Valve	02
5	Valve	03
6	Valve	04
7	Valve	05
8	None	--
9	Valve	06
10	Pump	1

*NOTE* After making changes, be sure to exit and return again to check for errors. The Green Field ECO will delete and replace conflicting assignments with '---'.

### 5.3 Device List

The Device List screen allows you to view what type, and how many devices are currently defined. This screen automatically updates depending on the devices set in the 7.1 screen.

DEVICE LIST	
Type	Qty.
Valves	3
Main Valves	1
Pumps	3
Filters	2
Main Filter Valve	--
Dosing Channels	4
Dosing Boosters	--
Selectors	--
Agitators	--
Cooling	2

## 5.4 Digital Input

1. Go to Installation > Digital Input.

2. Place the cursor on the relevant line and press . A selection list will

open. Choose the required sensor and press  to confirm.

Inputs 1-32 are according to the following:

- Card no. 1: inputs 1 – 8
- Card no. 2: inputs 9 – 16
- Card no. 3: inputs 17 – 24
- Card no. 4: inputs 25 – 32

DIGITAL INPUT	
D-In	Input Function
1	Water Meter 1
2	Dosing Meter 1
3	Dosing Meter 2
4	< None >
5	< None >
6	Water Meter 2

## 5.5 Analog Input

1. In *Installation* > *Analog Input*, define input function(s) as Analog Sensors.

ANALOG INPUT		
Channel	Input Function	Valid
1	pH Sensor	NO
2	EC Sensor	YES
3	Humidity Sensor	YES
4	Temp. Sensor 1	YES
5	Temp. Sensor 2	YES

2. In *Setup* > *Analog Conversion Table*:

- a. Select the sensor type
  - b. Under Valid, select YES.
3. In *Test* > *Analog Sensor*, view the actual sensor values.
4. In *Program* > *Ext Condition*, configure the External Condition Program for the analog sensors.
- a. Enter the beginning and ending time for each program.

EXTERNAL CONDITION PROGRAM			
#	From hh:mm	To hh:mm	Start An. Dry Cont.
1	10:00	12:00	
2	11:00	12:00	Dry Con 1
3	12:00	13:00	Dry Con 1
4	--:--	--:--	<NONE>
5	--:--	--:--	<NONE>
6	--:--	--:--	<NONE>
7	--:--	--:--	<NONE>
8	--:--	--:--	<NONE>

- b. Under Start An. Dry Cont., define the input type.

EXTERNAL CONDITION PROGRAM			
#	From hh:mm	To hh:mm	Start An. Dry Cont.
1		12:00	
2		12:00	Dry Con 1
3		13:00	Dry Con 1
4		--:--	<NONE>
5		--:--	<NONE>
6		--:--	<NONE>
7		--:--	<NONE>
8		--:--	<NONE>

- c. Define The Trigger Type

EXTERNAL CONDITION PROGRAM			
#	Trigger Type	Stop An. Dry Cont.	Oper. to Start
1	Multi Shot		---
2	Multi Shot	Dry Con 2	One Shot
3	One Shot	Dry Con 14	Multi Shot
4	One Shot	<NONE>	Only If On
5	One Shot	<NONE>	---
6	One Shot	<NONE>	---
7	One Shot	<NONE>	---
8	One Shot	<NONE>	---

- d. Under Stop An. Dry Con., define the input type.

EXTERNAL CONDITION PROGRAM			
#	Trigger Type	Stop An Dry Cont.	Oper. to Start
1			---
2		Dry Con 2	---
3		Dry Con 14	---
4		<NONE>	---
5		<NONE>	---
6		<NONE>	---
7		<NONE>	---
8		<NONE>	---

e. Under Oper. to Start, choose the required symbol.

EXTERNAL CONDITION PROGRAM			
#	Stop An Dry Cont.	Oper. to Start	Start Value
1	<NONE>	>	
2	Dry Con 2	---	
3	Dry Con 14	---	
4	<NONE>	---	
5	<NONE>	---	
6	<NONE>	---	
7	<NONE>	---	
8	<NONE>	---	

f. Under Start Value, enter the required value to start the analog sensor.  
Under Stop Value, entered the required value to stop the analog sensor.

## 5.6 Hot Keys and Status Screens

*Hot Key 1: Next Irrigation*

SYSTEM SETUP			
	SET	ACTUAL	
CYCLE	1	1	START AT
WATER	00:10:00	00:10:00	
FLOW	100.00	100.00	
EC		1.5	LEFT
pH		5.3	
	STATUS		ACTIVE
PROGRAM:	07:43:23		IRRIGATION
VALVE:	03-Apr-13		ALARM
	MESSAGE		

Hot Key 2: Irrigation Process

IRRIGATION PROCESS				
Prog:	Valve:	Time: 08:07:23		
	Set	Actual	Flow	Valve
Water				

Hot Key 3: Program Status

PROGRAM STATUS			
Program: 1	3-Apr-13	09:12:35	
Status	Wait		
Time - Minimum	---		
Time - Maximum	---		
Rad Sum – Measured/Limit	-/-		
Clock Starts – Given/Set	-/-		
Starts Due to Rad Sum	---		
Starts Due to Max Time	---		
Total Cycles Given	1		
Last Start	12:00		
Elapsed Time	3:00		
Next Start	15:43		

Hot Key 4: Water Flow & EC/pH Status

WATER		EC/pH		
Status	Wait		EC	pH
Nom. Flow	-----	Target	---	---
Act. Flow	-----	Actual	---	---
	Open(%)	Min(%)	Prg(%)	Max(%)
Chan. 1	---	---	---	---
Chan. 2	---	---	---	---
Chan. 3	---	---	---	---
Chan. 4	---	---	---	---

*Hot Key 5: Filter Flushing Status*

<b>FILTER FLUSHING STATUS</b>	
<b>Item</b>	
<b>Flush Status</b>	<b>OFF</b>
<b>Time to Next Flush</b>	<b>--:--:--</b>
<b>Delta Pressure (Digital)</b>	<b>OFF</b>
<b>Flushing Filter No.</b>	<b>--</b>
<b>Remaining Filters Qty.</b>	<b>0</b>
<b>Delay</b>	<b>00:00</b>
<b>Current Delta Pressure</b>	<b>----</b>

*Hot Key 6: Temperature and Humidity Status*

<b>TEMP &amp; HUMIDITY</b>		
<b>No.</b>	<b>Temp.</b>	<b>Humidity</b>
<b>1</b>	<b>&lt;NONE&gt;</b>	<b>&lt;NONE&gt;</b>
<b>2</b>	<b>&lt;NONE&gt;</b>	<b>----</b>
<b>AVG.</b>	<b>&lt;NONE&gt;</b>	<b>&lt;NONE&gt;</b>
<b>Sen#T</b>	<b>H VPD</b>	<b>VPD SUM</b>
	<b>&lt;NONE&gt;</b>	<b>0.0</b>

# 6 Controller Test Procedure

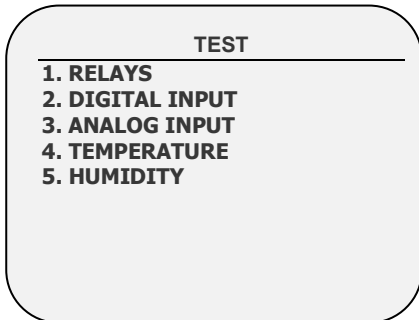

The Test menu provides a quick way of verifying functionality.

- Relays, page 32
- Digital Input, page 33
- Analog Input, page 33
- Temperature, page 34
- Humidity, page 34

## 6.1 Relays

The Relays Test screen allows you to check the current output status and verify proper operation.

TEST RELAYS		
OUTPUT	FUNCTION	STATUS
1	DOSING CHANNEL 1	OFF
2	DOSING CHANNEL 2	OFF
3	DOSING CHANNEL 3	OFF
4	DOSING CHANNEL 4	OFF
5	DOSING CHANNEL 5	OFF
6	DOSING CHANNEL 6	OFF
7	DOSING CHANNEL 7	OFF
8	DOSING CHANNEL 8	OFF

The setting switches automatically between ON and Off depending on device actual status.

To manually test relay functionality, move the cursor to required device using the arrow

keys and press ; the device is turned on and the setting shows MAN.

Press  again to return to automatic operation.

- OFF: The output is not active.



- **ON:** The output is automatically turned on by the relevant program.
- **Man:** Manual operation of the output. The manual operation resets after 30 minutes of being idle, to prevent you from forgetting to set it back to automatic operation.
- **Load Output Level:** Output level in A/D values. The value is constantly updated in accordance with relay operation and output level changes. This value is used to calculate the A/D threshold value to be considered as a short circuit.

## 6.2 Digital Input

The Digital Input test screen allows you to verify the proper operation of digital inputs and sensors. Digital inputs are defined as meters (water meters, dosing meters, etc.) that count the number of closed contacts from 0 to 255 and automatically restart back from 0. Other digital inputs (Dry contact, Ext. Pause, etc.) show either 0 when the contact is open or 1 when the contact is closed.

Note that the card number is set according to its jumpers regardless of its location (local or extension box).

DIGITAL VALUE	
Channel	Value
1	59
2	0
3	0
4	0
5	0
6	0

- Perform a dry test. Using a magnet, get a pulse. Attach the magnet to get a pulse from the read of the cable.
- Verify the water, fertilizer, and any auxiliary meters.
  - Delta pressure: 1 = ON, 0 = OFF

## 6.3 Analog Input

Analog inputs will show values from 0 to 1023.

ANALOG INPUT	
Channel	Value
pH	564
EC	345
Hum.	376
Temp1	511
Temp2	453

Sensor type	Description
pH sensor	pH = 0 - A/D = 205
	pH = 7.0 - A/D = 615
	pH = 14.0 - A/D = 1023
EC sensor	EC = 0 - A/D = 205
	EC = 2.0 - A/D = 370
	EC = 10.0 - A/D = 1024
Humidity sensor	RH% = 0 - A/D = 0
	RH% = 50 - A/D = 308
	RH% = 100 - A/D = 620
Temp sensor	T°C = 0 - A/D = 768
	T°C = 25 - A/D = 489
	T°C = 50 - A/D = 250

## 6.4 Temperature

This table shows the current temperature sensor readings in degrees (Celsius or Fahrenheit depending on the setup in the screen).

TEMPERATURE	
No.	Value
1	27.3
2	28.6

## 6.5 Humidity

This table shows the current humidity sensor readings in percentage relative humidity.

HUMIDITY	
No.	Value
1	57.3

# 7 System Configuration Procedure

- CONFIGURATION**
1. DEVICE DELAY CONFIGURATION
  2. PUMP STATION CONFIGURATION
  3. VALVE CONFIGURATION
  4. VALVE FLOW RATE
  5. WATER METER
  6. DOSING CHANNEL CONFIGURATION
  7. DOSING CONFIGURATION
  8. DRAINAGE CONFIGURATION
  9. EC/PH CONFIGURATION
  10. COOLING CONFIGURATION
  11. MISTING CONFIGURATION

- Device Delay Configuration, page 35
- Pump Station Configuration, page 38
- Valve Configuration, page 39
- Valve Flow Rate, page 40
- Water Meter, page 40
- Dosing Channel Configuration, page 42
- Dosing Configuration, page 43
- Drainage Configuration, page 44
- EC/pH Configuration, page 45
- Cooling Configuration, page 45
- Misting Configuration, page 45
- History Resolution, page 46
- System Nutrigation™ Check, page 47

## 7.1 Device Delay Configuration

The Device Delay Configuration screen enables defining the startup and shutdown order of the irrigation process.

	On mm:ss	Off mm:ss
Pump	--:--	00:35
Main Valve	01:00	00:15
Valve	01:30	--:--
IN-PROGRAM DELAYS		
Shift delay (sec)		-30
Stagger delay (sec)		20

- On (mm:ss): On is the definition of the startup order. The set times are taken from procedure startup. The device with the shortest time will be started first and shifted to procedure startup. Therefore it is recommended that the device that is to be started first be set as 00:00 (automatically changes to --:--).
- Off (mm:ss): Off is the definition of the shutdown order of the irrigation process. The set times are taken from procedure shutdown. The device with the shortest time will be stopped first and shifted to procedure shutdown. Therefore it is recommended that the device that is to be stopped first be set as 00:00 (automatically changes to --:--).

### 7.1.1 EXAMPLE OF DEVICE STARTUP & SHUTDOWN ORDER

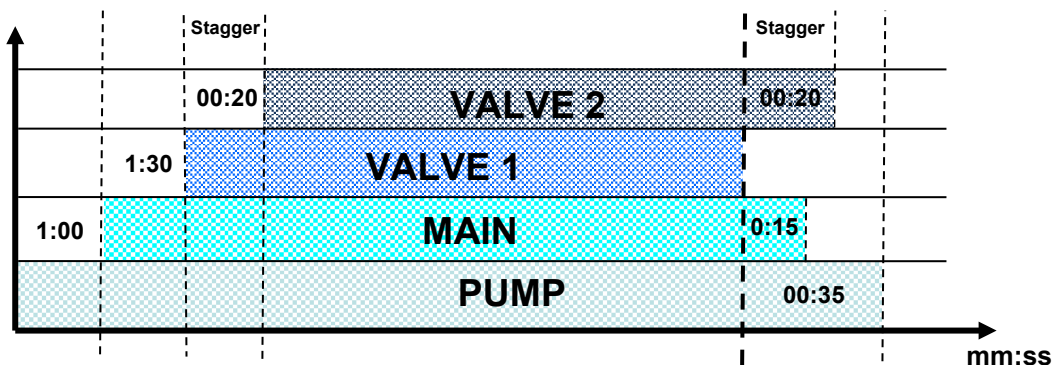

- **Startup:** According to the settings above, the pump will be turned on first (on procedure startup). The main valve will be opened one minute later (one minute from procedure startup) the valve.
- **Shutdown:** According to the settings above the valve will be turned off first (on procedure shutdown). The main valve will be closed after 15 seconds and the pump will be closed 20 seconds later (35 seconds from procedure shutdown).

*NOTE It is recommended that the device that should be started (stopped) first be defined as zero (will appear as --:--).*

### IN-PROGRAM DELAYS

- **Shift delay (sec):** Define the time (in seconds) between each valve change. The shift delay can also be a shift advance by inserting a negative value. This means that the next valve will start before the previous one.
- **Stagger delay (sec):** Define the time (in seconds) for the first shift and the last shift delay between valves (inside of group).

## 7.1.2 EXAMPLE OF STAGGER VALVE DELAY – MULTIPLE SHIFTS

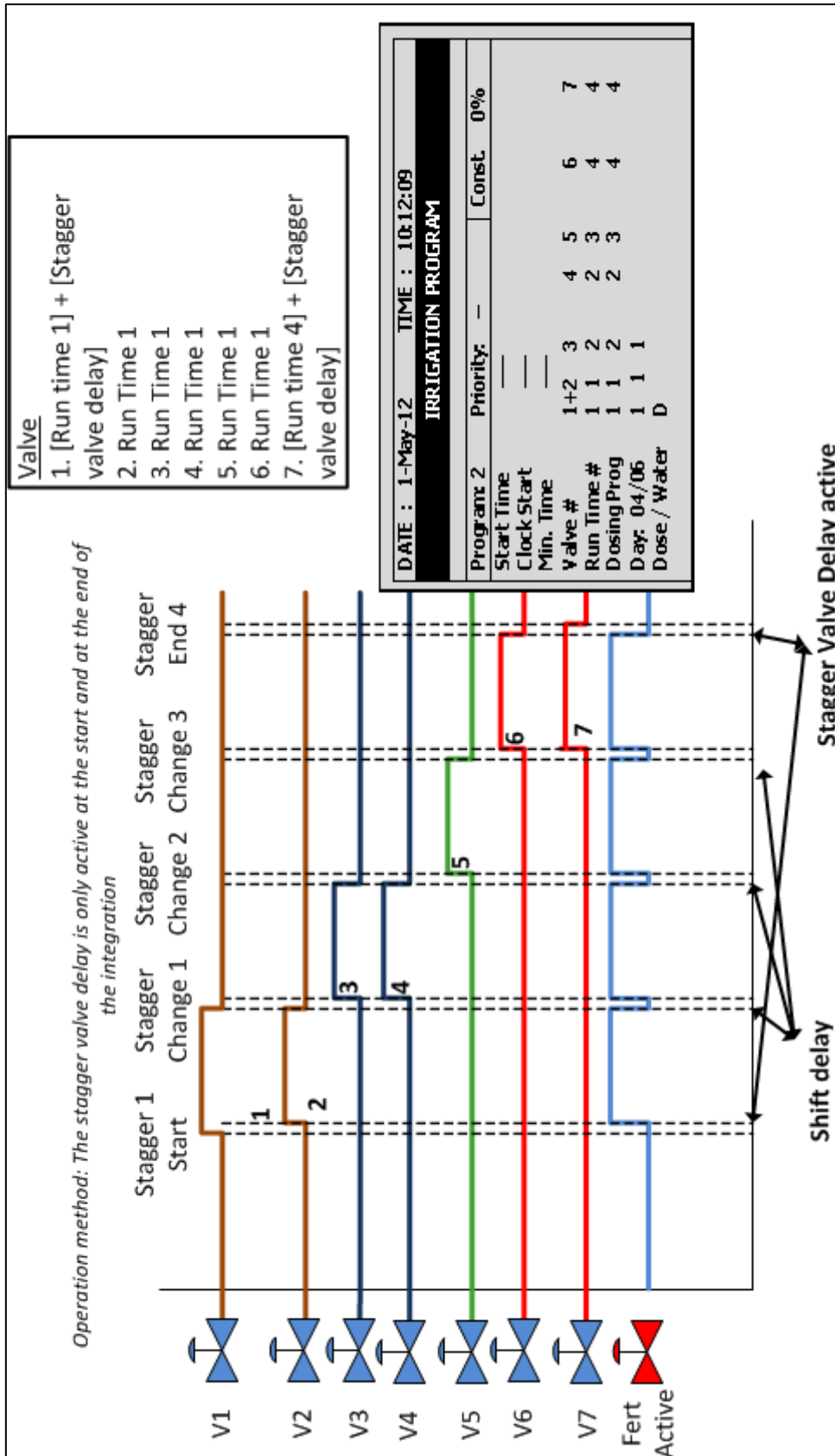

## 7.2 Pump Station Configuration

The Green Field ECO can include up to six pumps. Each valve (irrigation, cooling, or misting) can be connected to one of the pumps or to the pump station. The pump station is a group of pumps (out of the six possible pumps) that will be started in accordance with the required flow. The Pump Station configuration screen allows you to define which pumps are part of the station, the capacity of the various pumps and their startup and shutdown delays.

Pump Station Configuration			
Pump No.	Capacity m3/h	Stability mm:ss	Off Delay mm:ss
1	----	--:--	--:--

Pump Station Configuration			
Pump No.	Capacity m3/h	Stability mm:ss	Off Delay mm:ss
1	5.00	00:20	00:00

The Green Field ECO automatically calculates the expected flow and determines which pump (or pumps) should be started (see Valve Configuration for additional information regarding flow calculation). The Green Field ECO will start the minimal number of pumps required to supply the calculated flow rate.

If several pumps should be started, the Green Field ECO starts from the largest to the smallest and will turn them off from the smallest to the largest.

- **Pump No.:** Pump number.
- **Capacity:** Define pump capacity in m3 or gallon. This will be the maximum pump capacity, above which the Green Field ECO will turn on another pump (if available).
- **Stability (mm:ss):** Define stability time. Stability time is the startup time required for current pump before next pump can be started up. Stability time is usually used to prevent voltage drop down and water hammer (see [Pump Startup Order](#) schema).
- **Off Delay (mm:ss):** Define off delay. Off delay will be the delay time for current pump to stop after last pump has stopped. This delay is usually used to prevent water hammer (see [Pump Shutdown Order](#) schema).
- **Station (Yes/No):** Define whether the pump is part of the pump station.

The following is a startup and shutdown order schema according to the settings above and a calculated flow rate of 60 m<sup>3</sup>/h:

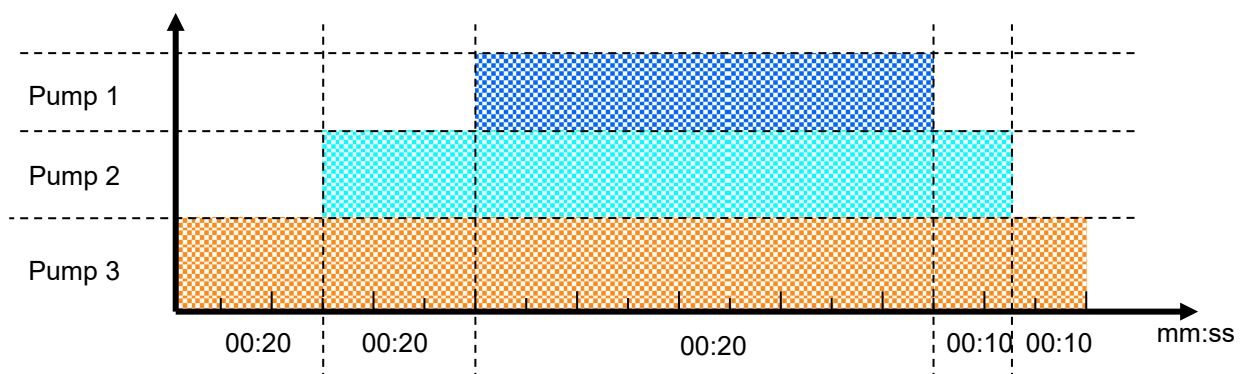

Figure 2: Pump startup & shutdown order

## 7.3 Valve Configuration

Valve configuration allows you to configure devices such as pumps, main valves, and drainage measurement of valves.

VALVE CONFIGURATION				
Valve No.	Pump	Main Valve	Water Meter	Drain Meter
115	Pump 2	1	2	2
116	Station	1	1	1
117	Pump 3	1	3	3
118	Station	1	1	1
119	Pump 4	1	4	4
120	Station	1	1	1
121	Pump 2	1	2	1
122	Station	1	1	1
123	Station	1	1	1
124	Pump 4	1	1	1

VALVE CONFIGURATION				
Valve No.	Main Valve	Water Meter	Drain Meter	Drain Type
115	1	2	2	Sample
116	1	1	1	Total
117	1	3	3	Sample
118	1	1	1	Total
119	1	4	4	Sample
120	1	1	1	Total
121	1	2	1	Total
122	1	1	1	Total
123	1	1	1	Total
124	1	1	1	Total

VALVE CONFIGURATION				
Valve No.	Water Meter	Drain Meter	Drain Type	Sample %
115	2	2	Sample	50.0000%
116	1	1	Total	-----
117	3	3	Sample	80.0000%
118	1	1	Total	-----
119	4	4	Sample	100.0000%
120	1	1	Total	-----
121	2	1	Total	-----
122	1	1	Total	-----
123	1	1	Total	-----
124	1	1	Total	-----

- **Valve No.:** Indication of the valve number.
- **Pump:** Define which pump or pump station should be started when irrigating this valve. When choosing Station, the Green Field ECO will choose which and how many pumps should be started to supply the required (calculated) flow. See Pump Station Configuration on page 38 for more information).
- **Main Valve:** Define which main valve should be opened when starting each valve.
- **Water Meter:** Configure a water meter to each valve. This option is only possible when the flow calculation (water meter type) is Standard.

*NOTE Make sure that you define an operative water meter. There is no protection against defining a water meter that isn't properly defined in the system.*

Note that when operating using Water Source (refer to Water Meter, page 40) a valve is not configured to a specific water meter. In this case, all water meters set in the system are relevant for each irrigation; their pulses are calculated for the flow rate. Therefore the Water Meter column is irrelevant in the Valve Configuration table.

*NOTE Make sure that you define an operative water meter. There is no protection against defining a water meter that isn't properly defined in the system.*

*NOTE When using more than one water meter only start two valves that are configured to the same water meter; the Green Field ECO uses only the water meter connected to the leading valve and does not sum the flow from the rest of the water meters. Dosing in this manner can create unexpected alarms and malfunctions!*

- **Drain Meter:** Define which drain meter this valve is connected to.
- **Drain Type:** Define drainage type:
  - **Total:** Drainage is collected from the complete valve area.
  - **Sample:** Drainage is collected from a representing part of the valve area.

Note that it is possible to set several valves to the same drain meter when working by 'Total'. The system does not allow operating several valves on the same meter when operating by 'Sample'.

- **Sample %:** When using sample drainage measurement it is required to define the ratio of the sample area to the complete valve area.

## 7.4 Valve Flow Rate

VALVE FLOW RATE			
Valve No.	Nominal m <sup>3</sup> /h	Minimum m <sup>3</sup> /h	Maximum m <sup>3</sup> /h
51	5.000	3.750	6.250
52	19.000	14.250	23.750
53	20.000	15.000	25.000
54	22.000	16.500	27.500
55	13.000	9.750	16.250
56	15.000	11.250	18.750
57	22.000	16.500	27.500
58	30.000	22.500	37.500
59	11.000	8.250	13.750
60	14.000	10.500	17.500

VALVE FLOW RATE			
Valve No.	Nominal m <sup>3</sup> /h	Minimum m <sup>3</sup> /h	Maximum m <sup>3</sup> /h
246	5.000	3.750	6.250
247	13.000	9.750	16.250
248	16.000	12.000	20.000
249	19.000	14.250	23.750
250	4.000	3.000	5.000
251	23.000	17.250	28.750
252	18.000	13.500	22.500
253	25.000	18.750	31.250
254	5.000	3.750	6.250
255	22.000	16.500	27.500

- **Nominal:** Define nominal valve flow rate (m<sup>3</sup>/h or gallon/min). The Green Field ECO uses the set nominal flow rate for calculating the ratio between valves when starting a few valves together, the boundaries for alarms, the total flow rate for calculating how many pumps to start, etc. Therefore it is recommended to try and set the nominal flow rate as close as possible to the actual flow rate.
- **Minimum:** Minimum valve flow rate, under which the system will generate a low flow alarm. When changing the Nominal flow rate this setting is automatically set to 25% under the nominal flow and can be manually changed.
- **Maximum:** Maximum valve flow rate, above which the system will generate a high flow alarm. When changing the nominal flow rate this setting is automatically set to 25% above the nominal flow and can be manually changed.

*NOTE* When starting several valves simultaneously the system will sum their nominal, minimal and maximal flow rates. An alarm will be generated only if the measured flow rate is lower than the total minimum, or higher than the total maximum.

*NOTE* When starting several valves simultaneously, the quantities between them will be divided based on the ratio of their nominal flow.

## 7.5 Water Meter

- **Ratio:** Set volume per pulse of each water meter or auxiliary meter.
- **Type:** Define type of flow calculation:
  - **Standard:** In this function valves which are operated in a group should be connected to the same water meter.



*NOTE If a few valves configured to different water meters will be started simultaneously, the Green Field ECO uses the flow measured by the water meter connected to the leading valve.*

- **Water source:** The Green Field ECO will sum or deduct flow measured simultaneously from a few water meters. When choosing this function an additional column called "SUM" will appear, this column enables to define which water meters should be summed and which deducted from the total measured flow.

*NOTE Flow calculation type is a general definition for all water meters, therefore when changing type of water meter for one of the water meters the type will be changed for all water meters.*

*NOTE When setting flow calculation (water meter type) to Water source it is not possible to configure valves to water meters.*

- **Sum:** Define whether flow measured by each water meter should be added to the total measured flow or deducted:
  - "+" Flow measured by this water meter will be added to the total measured flow.
  - "-" Flow measured by this water meter will be deducted from the total measured flow.

*NOTE Since flow cannot be negative, if the controller measures negative flow it will show zero.*

*NOTE If all valves are set to "-" the system ignores the measured flow and will use the nominal flow (based on the nominal flow).*

WATER METER		
Description	Ratio	Type
Water Meter 1(L/P)	10.000	W.SOURCE
Water Meter 2(L/P)	20.000	W.SOURCE
Water Meter 3(L/P)	50.000	W.SOURCE
AUX Meter 1 (L/P)	----	-----
AUX Meter 2 (L/P)	----	-----
AUX Meter 3 (L/P)	----	-----
AUX Meter 4 (L/P)	----	-----
AUX Meter 5 (L/P)	----	-----
AUX Meter 6 (L/P)	----	-----

WATER METER		
Description	Type	Sum
Water Meter 1(L/P)	W.SOURCE	+
Water Meter 2(L/P)	W.SOURCE	+
Water Meter 3(L/P)	W.SOURCE	+
AUX Meter 1 (L/P)	-----	-----
AUX Meter 2 (L/P)	STANDARD	-----
AUX Meter 3 (L/P)	W.SOURCE	-----
AUX Meter 4 (L/P)	-----	-----
AUX Meter 5 (L/P)	-----	-----
AUX Meter 6 (L/P)	-----	-----

WATER METER		
Description	Ratio	Type
Water Meter 1(L/P)	10.000	STANDARD
Water Meter 2(L/P)	20.000	STANDARD
Water Meter 3(L/P)	50.000	STANDARD
AUX Meter 1 (L/P)	----	-----
AUX Meter 2 (L/P)	----	-----
AUX Meter 3 (L/P)	----	-----
AUX Meter 4 (L/P)	----	-----
AUX Meter 5 (L/P)	----	-----
AUX Meter 6 (L/P)	----	-----

**NOTE** It is very important to choose the correct flow meter for the application. Choosing a wrong flow meter might result in measurement errors or an inaccurate control. For instructions regarding how to choose the correct water meter see *Green Field ECO Irrigation > General > Flow meter determination*.

## 7.6 Dosing Channel Configuration

DOSING CHANNEL CONFIGURATION			
No.	Pump	Method	Ratio
1	Venturi	Time(Lit/h)	150.000
2	Venturi	Time(Lit/h)	200.000
3	Venturi	Time(Lit/h)	300.000
4	Venturi	Time(Lit/h)	300.000

DOSING CHANNEL CONFIGURATION			
No.	Ratio	React	High(%)
1	150.000	EC	50
2	200.000	EC	50
3	300.000	ACID	50
4	300.000	PASSIVE	---

DOSING CHANNEL CONFIGURATION			
No.	High(%)	Low(%)	U/P(L)
1	50	80	0.1000
2	50	50	-----
3	50	50	-----
4	---	---	-----

- **Pump:** Select the type of dosing pump:
  - **Venturi:** The dosing unit consists of Venturi driven injectors. The dosing booster will be turned on when fertigation is active.
  - **Hydraulic:** The dosing unit consists of hydraulic fertilizer pumps. The dosing booster is not needed and will not be turned on when Fertigation is active. When working with hydraulic pump, the method can only be Liter/Pulse and EC & pH control is not possible.
  - **Electric:** The dosing unit consists of electrical fertilizer pumps. The dosing booster is not needed and will not be turned on when Fertigation is active.
- **Method:** Select the operating method:
  - **Liter/Pulse:** Define whether a dosing meter is connected to this channel and used for control purposes. Set the volume per pulse on the Ratio column.
  - **Time (cc/sec):** Define whether the calculated flow rate of the dosing channel is in CC (gallons) of fertilizer per second.
  - **Time (Liter/min):** Define whether the calculated flow rate of the dosing channel is in liters (gallons) per minute.
  - **Time (Liter/Hour):** Define whether the calculated flow rate of the dosing channel is in liters (gallons) per Hour.
- **Ratio**
  - **Method is Time:** Define calculated flow rate, this will be the flow rate of the channel when completely open.
  - **Method is Liter/Pulse:** Define the volume per pulse.
- **React:** Set the required use of the channel:
  - **EC:** The channel is used to increase measured EC, meaning it will be opened more when the measured EC is lower than the set EC.
  - **pH:** The channel is used to decrease measured pH, meaning it will be opened more when the measured pH is higher than the set pH.
  - **Passive:** The channel does not respond to changes in measured EC/pH, meaning it will be opened as set in the dosing program regardless of the EC/pH values.
  - **Alkali:** The channel is used to increase measured pH, meaning it will be opened more when the measured pH is lower than the set pH.

*NOTE If EC/pH control is off, or the channel is used for proportional injection only (for example in order to inject chemicals) set reaction to passive.*

- **High %:** set an injection percentage limit. This percentage will limit the deviation from set dosing recipe when Green Field ECO is injecting more than specified in order to try and reach the target EC/pH values.
- **Low %:** set an injection percentage limit. This percentage will limit the deviation from set dosing recipe when Green Field ECO is injecting less than defined in order to try and reach the target EC/pH values.
- **V/P(L/G):** This parameter is disabled when operating by Liter/Pulse. Define the volume per pulse of the dosing meter (liters or gallons). Only required when using a dosing meter for measurement and alarm purposes. When using a dosing meter for control purposes the volume per pulse of the dosing meter should be defined on the Ratio column. The letter between the brackets indicates whether the volume units are in Liter or Gallon.

## 7.7 Dosing Configuration

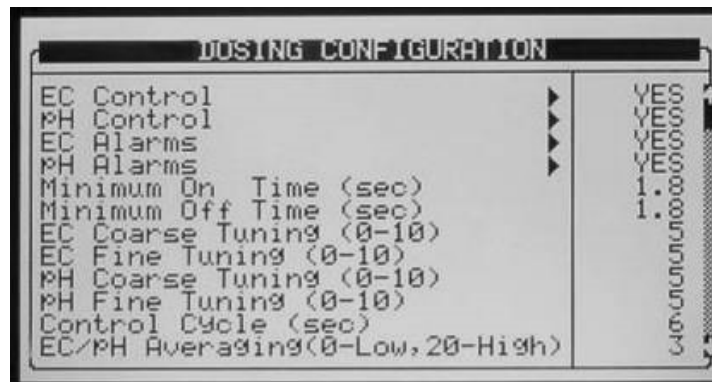

- **EC Control:** Define whether EC control should be operative.
- **pH Control:** Define whether pH control should be operative.
- **EC Alarms:** Define whether EC related alarms are operative. When EC control is set to 'Yes', EC Alarms are automatically set to 'Yes' and cannot be changed.
- **pH Alarms:** Define whether pH related alarms are operative. When pH control is set to 'Yes' pH Alarms are automatically set to 'Yes' and cannot be changed.
- **Minimum On Time (sec):** Define the minimum time the dosing regulator can be open. This feature is used to protect the regulator from being excessively turned on and off. The minimum allowed on time is 0.4 seconds.
- **Minimum Off Time:** Define the minimum time the dosing regulator can be off. This feature is used to protect the regulator from being excessively turned on and off. The minimum off time allowed is 0.4 seconds.
- **EC Coarse Tuning (0-10):** EC Coarse Tuning is used to adjust the speed and strength of the EC control. A higher value will result in faster correction but might lead to over shooting (see Appendix 1 – General > EC/pH correction adjustment for further information).
- **EC Fine Tuning (0-10):** EC Fine Tuning is used to fine tune the EC control shooting (see Green Field ECO Irrigation > Part 2 > General > EC/pH correction adjustment for further information).

- **pH Coarse Tuning (0-10):** pH Coarse Tuning is used to adjust the speed and strength of pH control. A higher value will result in faster correction but might lead to over shooting (see Green Field ECO Irrigation > Part 2 > General > EC/pH correction adjustment for further information).
- **pH Fine Tuning (0-10):** pH Fine Tuning is used to fine tune pH control shooting (see Green Field ECO Irrigation > Part 2 > General > EC/pH correction adjustment for further information).
- **Control Cycle (sec):** Define the control cycle for EC/pH control. This should be the time it takes the system since it injected fertilizer/acid until the change in recognized by the system.
- **EC/pH Averaging (0-Low, 20-High):** Averaging factor for EC/pH measurement. EC/pH averaging should be used to enable correction when injection is not homogenous.
- **Dosing Booster Off Delay (mm:ss):** Define the time that the dosing booster should be left on after dosing has ended. This time is usually used to circulate the acid and nutrients in order to prevent high concentrations in the area of the venturies and dosing booster when the system is idle.
- **Dosing by QTY. Method:**
  - **Bulk:** All channels set to QTY (quantity) dosing method will inject the set quantity in one bulk, starting after water before quantity/time has elapsed.
  - **Spread Out:** The set dosing quantity of all channels set to QTY (quantity) dosing method will be spread throughout the irrigation.

## 7.8 Drainage Configuration

Meter No.	Ratio Liter/Pulse	On Delay	Off Delay
1	1.000	00:01:00	00:03:00
	1.000	00:06:00	00:05:00
	1.000	00:10:00	00:10:00
	----	---:---:--	---:---:--
	----	---:---:--	---:---:--
	----	---:---:--	---:---:--
	----	---:---:--	---:---:--

- **Ratio:** Define volume per pulse of the drainage meters (liter/pulse or gallon/pulse).
- **On Delay:** Define how long a valve, which is configured to this drainage measurement, should be open before the measured drainage is related to this valve. All drainage measured before this time has elapsed (although the valve is open) will still be related to the previously opened valve that was configured to this drainage sump.
- **Off Delay:** Define how long after irrigation has finished, the measured drainage should still be related to the previous irrigation. This value is used to “tell” the controller when to stop relating drainage to the previous irrigation and write it to all relevant history tables.

## 7.9 EC/pH Configuration

EC/pH CONFIGURATION		
Sensor	4 mA	20 mA
EC	0	10
pH	0	14

Define the range of the EC/pH transmitters.

- Default settings for EC/pH transmitters is:
  - EC: zero to 10 mS
  - PH: zero to 14 ppm
- EC Control Sensor: Define which EC sensor should be used for control. When setting EC 1 + EC 2, EC1 will be used for control, and EC2 will be used for verification.
- pH Control Sensor: Define which pH sensor should be used for control. When setting pH 1 + pH 2, pH1 will be used for control, and pH2 will be used for verification.

## 7.10 Cooling Configuration

The cooling configuration screen will only be visible after one (or more) cooling valves have been defined in the [DEVICE LAYOUT](#) table.

COOLING CONFIGURATION		
Cool No.	Pump	Main Valve
1	2	1
2	3	1

- Pump: Configure a pump to each cooling valve. This setting is not necessary if the cooling pump is not controlled by the Green Field ECO.
- Main Valve: Configure a main valve to each cooling valve. This setting is not necessary if the cooling doesn't have a main valve.

## 7.11 Misting Configuration

MISTING CONFIGURATION		
Mist. No.	Pump	Main Valve
1	1	1

- **Pump:** Configure a pump for each misting valve. This setting is not necessary if the misting pump is not controlled by the Green Field ECO.
- **Main Valve:** Configure a main valve to each misting valve. This setting is not necessary if the misting doesn't have a main valve.

## 7.12 History Resolution

Program how often the computer collects sensor data (keep in mind that lower resolution fills the memory in short period and overwrites the old data).

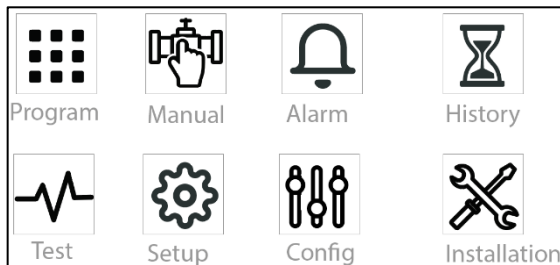

1. Select Controller number (in case of multiple controllers in the network, name each controller with a different number

SYSTEM SETUP	
<b>Language</b>	
Temperature Unit	°C
Volume Unit	Metric
<b>Maximum Cooling Parallel</b>	<b>1</b>
<b>Maximum Misting Parallel</b>	<b>1</b>
<b>STOP IRRIGATION</b>	
<b>During Filter Flushing</b>	No
<b>During Cooling Process</b>	No
<b>During Misting Process</b>	No
<b>STOP DOSING</b>	
<b>During Filter Flushing</b>	No

SYSTEM SETUP	
<b>Main Screen</b>	
Default Hotkey Number	5
History	
<b>History Resolution</b>	<b>1 Hour</b>
<b>Weather Station</b>	
<b>Controller Function</b>	LOCAL
Operation Mode	
<b>Automatic return to RO mode</b>	NO
<b>Return period to RO mode</b>	00:10
Communication	
<b>Controller Number</b>	<b>1</b>
<b>Port Protocol</b>	<b>GREEN NET</b>
<b>Baud Rate</b>	<b>9600</b>

2. Select the communication baud rate between controllers and the PC

## 7.13 System Nutrigation™ Check

- Check if EC/pH is on Target
- Water Run Time
- Start/Stop Valve

### 7.13.1 CHECK IF EC/PH IS ON TARGET

1. Go to Program > Dosing.
2. Enter required amount of fertilizer to inject per dosing channel in l/m<sup>3</sup> (USA: Gallon/1000 gallon)
3. Enter required target EC/PH levels.

### 7.13.2 WATER RUN TIME

1. Main menu: Program, Manual, Alarm, History, Test, Setup, Config, Installation. 'Program' is selected.

2. PROGRAM menu: 1. IRRIGATION, 2. WATER RUN TIME, 3. DOSING, 4. EXT. CONDITION, 5. AGITATOR, 6. SELECTOR, 7. FILTER FLUSHING, 8. COOLING, 9. MISTING, 10. WATER HEATING. 'WATER RUN TIME' is selected.

3. WATER RUN TIME PROGRAM table:

#	Method	Water	Before	After
1	TIME	00:10:00	00:00:00	00:00:00
1	OTV.	0.000	0.000	0.000
2	OTV.	0.000	0.000	0.000
3	OTV.	0.000	0.000	0.000
4	OTV.	0.000	0.000	0.000
5	OTV.	0.000	0.000	0.000
6	OTV.	0.000	0.000	0.000
7	OTV.	0.000	0.000	0.000
8	OTV.	0.000	0.000	0.000
9	OTV.	0.000	0.000	0.000
10	OTV.	0.000	0.000	0.000
11	OTV.	0.000	0.000	0.000

Enter water run time or quantity

### 7.13.3 START/STOP VALVE

1. Main menu: Program, Manual, Alarm, History, Test, Setup, Config, Installation. 'Manual' is selected.

2. MANUAL OPERATION menu: 1. IRRIGATION PAUSE, 2. START/STOP PROGRAM, 3. START/STOP VALVE, 4. FILTER FLUSHING. 'START/STOP VALVE' is selected.

3. START/STOP VALVE table:

Valve	Run Time #	Dosing Program
1	1	1

Run Time Program (1)  
Dosing Program (1)

WATER RUN TIME PROGRAM table (repeated from previous section):

#	Method	Water	Before	After
1	TIME	00:10:00	00:00:00	00:00:00
1	OTV.	0.000	0.000	0.000
2	OTV.	0.000	0.000	0.000
3	OTV.	0.000	0.000	0.000
4	OTV.	0.000	0.000	0.000
5	OTV.	0.000	0.000	0.000
6	OTV.	0.000	0.000	0.000
7	OTV.	0.000	0.000	0.000
8	OTV.	0.000	0.000	0.000
9	OTV.	0.000	0.000	0.000
10	OTV.	0.000	0.000	0.000
11	OTV.	0.000	0.000	0.000

DOSING PROGRAM table:

Program	1					
1	EC	5.00	5.00	5.00	5.00	5.00
2	EC	5.00	5.00	5.00	5.00	5.00
3	EC	5.00	5.00	5.00	5.00	5.00
4	EC	5.00	5.00	5.00	5.00	5.00
5	ACID	3.00				
Target EC					1.50	
Target PH					P.OTV	
EC Dosing Method					P.OTV	
PH Dosing Method					P.OTV	

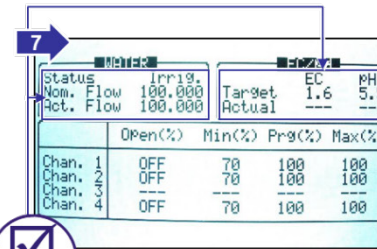
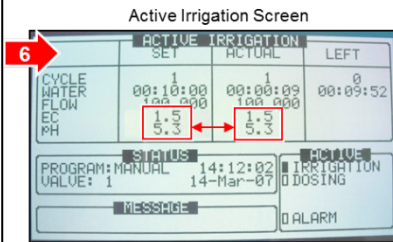
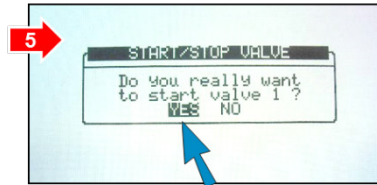
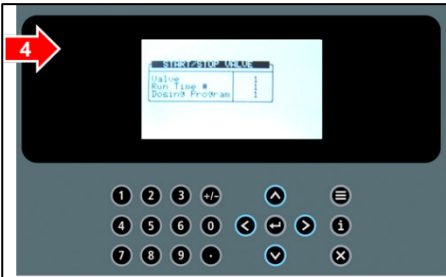

- ⇒ Difference between nominal and actual flow rate is ≤10%
- ⇒ Difference between target and actual EC/pH ≤0.2



# 8 Controller Advanced Settings

- Pump Station Configuration
- Multiple Water Meters
- Various Dosing Configurations
- Dosing Configuration

## 8.1 Pump Station Configuration

**1** Program Manual Alarm History  
 Setup **Config** Installation

**2** CONFIGURATION  
 1. DEVICE DELAY CONFIGURATION  
 2. **PUMP CONFIGURATION**  
 3. VALVE CONFIGURATION  
 4. VALVE FLOW RATE  
 5. WATER METER  
 6. DOSING CHANNEL CONFIGURATION  
 7. DOSING CONFIGURATION  
 8. EC/PH SENSOR RANGE  
 9. COOLING CONFIGURATION  
 10. MISTING CONFIGURATION

Pump No.	Capacity m <sup>3</sup> /h	Stability mm:ss	Off Delay mm:ss
1	50.000	--:--	--:--
2	70.000	00:10	00:10
3	80.000	00:15	00:15

**3** PUMP CONFIGURATION

**4** CONFIGURATION  
 1. DEVICE DELAY CONFIGURATION  
 2. PUMP CONFIGURATION  
 3. **VALVE CONFIGURATION**  
 4. VALVE FLOW RATE  
 5. WATER METER  
 6. DOSING CHANNEL CONFIGURATION  
 7. DOSING CONFIGURATION  
 8. EC/PH SENSOR RANGE  
 9. COOLING CONFIGURATION  
 10. MISTING CONFIGURATION

Valve No.	Main Valve	Water Meter
1	1	1
2	1	2
3	1	3

**5** VALVE CONFIGURATION

Valves 1, 2 & 3 allocated to Pumps 1, 2 & 3 (Pump station)  
 Pump station will be operated according to the valve/s nominal flow

## 8.2 Multiple Water Meters

**1** Program Manual Alarm History  
 Setup Config Installation  
 SELECT

**2** CONFIGURATION  
 1. DEVICE DELAY CONFIGURATION  
 2. PUMP CONFIGURATION  
 3. VALVE CONFIGURATION  
 4. VALVE FLOW RATE  
 5. WATER METER  
 6. DOSING CHANNEL CONFIGURATION  
 7. DOSING CONFIGURATION  
 8. EC/PH SENSOR RANGE  
 9. COOLING CONFIGURATION  
 10. MISTING CONFIGURATION

**3** WATER METER  
 Description Ratio  
 Water Meter 1(Liter/Pulse) 100.000  
 Water Meter 2(Liter/Pulse) 100.000  
 Water Meter 3(Liter/Pulse) 10.000  
 AUX Meter 1 (Liter/Pulse) -----  
 AUX Meter 2 (Liter/Pulse) -----  
 AUX Meter 3 (Liter/Pulse) -----  
 AUX Meter 4 (Liter/Pulse) -----  
 AUX Meter 5 (Liter/Pulse) -----  
 AUX Meter 6 (Liter/Pulse) -----

Enter capacity and type for additional water meters

CONFIGURATION  
 1. DEVICE DELAY CONFIGURATION  
 2. PUMP CONFIGURATION  
 3. VALVE CONFIGURATION  
 4. VALVE FLOW RATE  
 5. WATER METER  
 6. DOSING CHANNEL CONFIGURATION  
 7. DOSING CONFIGURATION  
 8. EC/PH SENSOR RANGE  
 9. COOLING CONFIGURATION  
 10. MISTING CONFIGURATION

VALVE CONFIGURATION

Valve No.	Main Valve	Water Meter
1	1	1
2	1	2
3	1	3

Configure meters to valves  
 Ex: Valves 1, 2 & 3 are allocated to water meters 1, 2 & 3 consecutively

NOTE Only one water meter can be measured at a time.

## 8.3 Various Dosing Configurations

- Method 1
- Method 2
- Method 3

### 8.3.1 METHOD 1

- Dosing pump control = Fert. Meter
- Dosing pump measurement = Fert. Meter
- Dosing pump type = Venturi or Electric

Inject fertilizer according to nominal capacity of pump/measure from fertilizer meter for verification purposes

DOSING CHANNEL CONFIGURATION

No.	Pump	Method	Ratio
1	Electric	Liter/Pulse	1.000
2	Venturi	Time(Lit/h)	300.000
3	Venturi	Time(Lit/h)	300.000

Set nominal pump capacity

### 8.3.2 METHOD 2

- Dosing pump control = Nominal Flow Rate
- Dosing pump measurement = Calculate dosing pump flow rate
- Dosing pump type = Venturi or Electric

No.	Pump	Method	Ratio
1	Hydraulic	Liter/Pulse	999.000
2	Venturi	Time(Lit/h)	999.000
3	Venturi	Time(Lit/h)	999.000

### 8.3.3 METHOD 3

- Dosing pump control = Fert. meter
- Dosing pump measurement = Fert. Meter
- Dosing pump type = Hydraulic

No.	Pump	Method	Ratio
1	Venturi	Time(Lit/h)	999.000
2	Venturi	Time(Lit/h)	999.000
3	Venturi	Time(Lit/h)	999.000

## 8.4 Dosing Configuration



Type of each channel configured by technician during installation process

EC- channel influenced by EC levels  
 ACID- channel to inject acid to reduce pH levels  
 PASSIVE- no EC/pH influence  
 ALKALI- channel to increase pH levels

- EC/pH Control Step 1
- EC/pH Control Step 2

### 8.4.1 EC/PH CONTROL STEP 1

System injects ± depending on EC levels, auto-adjust to meet target levels. Set limits for controller adjustments when levels are too high/low/

No.	Ratio	React	High(%)	Low(%)
1	200.000	ACID	50	50
2	999.000	EC	50	50
3	999.000	ACID	50	50

Example: If dosing Channel 1 is set by the grower to inject 10 liter/m<sup>3</sup>, the controller auto adjust range is 5 to 15 liter/m<sup>3</sup> in order to meet the EC level.

## 8.4.2 EC/PH CONTROL STEP 2

DOSING CONFIGURATION	
EC Control	V
pH Control	V
Minimum On Time (sec)	1.000000
Minimum Off Time (sec)	1.000000
Coarse Tuning (0-Slow,10-Fast)	10
Fine Tuning (0-Slow,10-Fast)	10
Control Cycle (sec)	10
EC/pH Averaging(0-Low,20-High)	10
Dosing Boost, Off Delay(mm:ss)	10:00
Dosing by QTY. Method	SPREAD

- EC/pH coarse tuning: When way off target, faster/stronger correction
- EC/pH fine tuning: Off target is low, slow/light correction
- Control cycle: Delay time from fertilizer/Acid injection point to EC/pH sensors reading
- EC/pH averaging: Balanced reading from EC/pH sensors
- Dose boost off delay: Time clear water circulated through system after fertigation stops and Venturi closes

# 9 Program Menu

In the Main Menu screen, place the cursor on the program icon and press , or press '1' to enter the Program Menu.



- Irrigation, page 54
- Using the Influences, page 59
- Setting the Influences, page 59
- Water Run Time, page 64
- Dosing, page 65
- Ext. Condition, page 67
- Agitator, page 68
- Selector, page 69
- Filter Flushing, page 69
- Cooling, page 70
- Misting, page 73
- Water Heating, page 74

*NOTE* To enter any of the menus, press the corresponding numeric key or scroll to the



 : a new window will appear. The first menu under Program is Irrigation.

## 9.1 Irrigation

The Irrigation Program screen includes all the settings for configuring automatic irrigation start. It depends heavily on the Water Run Time and dosing program screens; therefore it is recommended to configure these screens before irrigation takes place.

The Green Field ECO consists of 15 irrigation programs.

DATE : 20-Dec-06		TIME : 09:06:05	
IRRIGATION PROGRAM			
Program:	1	Priority:	-- Const. 50%
Start Time	06:30	12:30	15:00
Clock Start	2	1	1
Min. Time	01:00	--:--	--:--
Valve #	051+052	004+116	115 255
Run Time #	1	1	2 2 2
Dosing Prog	1	1	3 3 4 4
Day: 04/06	1	2	3 4 5 6
Dose/Water	D	W	- D W D

- **Program:** Select a program by entering the program number and confirm by pressing .
- **Priority:** Priority determines the order in which programs will take place. If start time is the same, higher priority programs come first. Higher priority programs do not stop currently operative programs.  
If start time and priority are the same, irrigation programs with a lower number are executed first. Priority ranges are between 0 and 15, 15 being the highest (See Green Field ECO Irrigation – Part 2 > Priority specifications for further information).
- **Const / Daily / Cond. / Rad Sum / VPD Sum:**
  - **CONST.:** Increase or decrease the amount of water for all valves included in this program. 0% means the quantities will be as specified in the Water Run Time program, 100% will be twice the amount and -50% will be half the amount specified in the Water Run Time Program. To decrease enter the required percentage of change, press the +/- key and confirm with the  key. The percentage of change is active until you specify otherwise.
  - **DAILY:** Increase or decrease the amount of water for all valves included in this program. 0% means the quantities will be as specified in the Water Run Time program, 100% will be twice the amount and -50% will be half the amount specified in the Water Run Time Program.  
To decrease, enter the required percentage of change, press +/- key and confirm with the  key. The percentage of change will be active only for the present day and will change automatically back to zero on End Day time.

**NOTE** CONST. % and DAILY % does not change Quantity / time of water before and water after settings, nor dosing quantities.

**NOTE** When setting watering program and using 'Spread' the percentage affects not only the water but also the dosing.

- **Cond.:** Specify whether the Condition program can trigger irrigations and choose a Condition program to start/stop irrigations. Irrigations will be started and stopped according to the settings of the relevant Condition program (see Ext. Condition, page 67, for additional information). If irrigation is not triggered due to Condition program until Max time has elapsed irrigation will be performed due to Max time.

When choosing Condition, the screen will be split in two. To view the day sequence, press the Down arrow when the cursor is placed on the bottom of the screen.

The Condition program has the third priority after active irrigation and uncompleted irrigation (See Green Field ECO Irrigation – Part 2 > Priority specifications for further information).

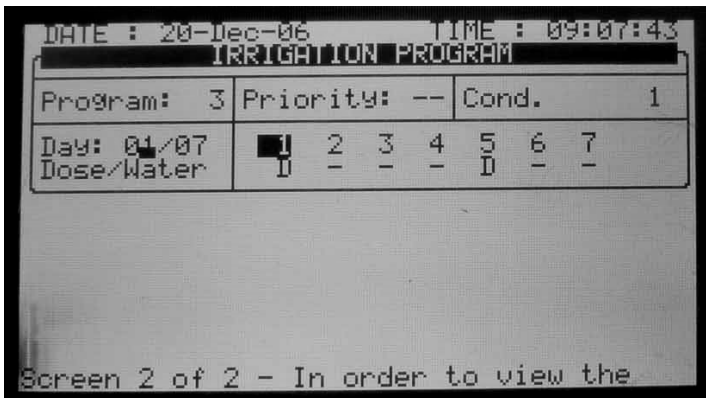
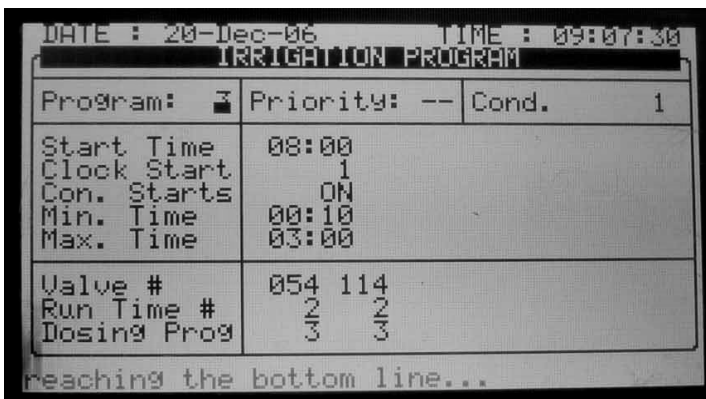

**NOTE** It is impossible to set the same Condition program for two different programs.

- **Rad Sum / VPD Sum:** Choose whether irrigations can be triggered by the radiation or VPD sum. The specific Rad Sum trigger is specified per period (see [Rad Sum Li.](#)).). If irrigation is not triggered due to Rad/VPD Sum until Max time has elapsed irrigation will be performed due to Max time.

DATE : 1-May-12		TIME : 10:12:09	
<b>IRRIGATION PROGRAM</b>			
<b>Program: 2</b>	<b>Priority: --</b>	<b>Rad Sum</b>	
<b>Start Time</b>	<b>07:00</b>	<b>12:00</b>	<b>16:00</b>
<b>Clock Start</b>	<b>1</b>	<b>--</b>	<b>--</b>
<b>Rad Sum Li.</b>	<b>200</b>	<b>---</b>	<b>100</b>
<b>Min. Time</b>	<b>01:00</b>	<b>00:30</b>	<b>--:--</b>
<b>Max. Time</b>	<b>02:00</b>	<b>--:--</b>	<b>--:--</b>
<b>Valve #</b>	<b>001</b>	<b>051+052</b>	<b>115 255</b>
<b>Run Time #</b>	<b>1</b>	<b>2 2</b>	<b>2 ---</b>
<b>Dosing Prog</b>	<b>1</b>	<b>2 2</b>	<b>3 2</b>
Screen 1 of 3 – In order to view the			

DATE : 1-May-12		TIME : 10:12:09	
<b>IRRIGATION PROGRAM</b>			
<b>Program: 2</b>	<b>Priority: --</b>	<b>Rad Sum</b>	
<b>Day: 04/06</b>	<b>1 2 3 4</b>	<b>5 6</b>	
<b>Dose / Water</b>	<b>D - D W</b>	<b>D W</b>	
Screen 2 of 3 – In order to view the			

*NOTE* When choosing Rad/VPD Sum the screen will be split in two. To view the day sequence, press the Down arrow on the bottom part of the screen.

- **Start time (hh:mm):** ENTER up to six start times (periods) per day for each program.
- **Clock Start:** Set the number of time-based irrigation cycles that will be performed in this cycle. The first cycle starts at the specified start time; subsequent cycles will start after the specified Min. Time.
- **Cond. Starts (appears only when Cond. Is selected):** On/Off.
  - **On:** Irrigations can be triggered by the Condition program when the specified Condition program settings are met (Condition program active).
  - **Off:** Irrigations will not be triggered by the condition program, regardless of the Condition program status.
- **Rad/VPD Sum Li.:** Specify the radiation/VPD sum limit at which irrigation will take place. The Rad/VPD Sum counter of the specific program is automatically reset when irrigation is performed. If Rad/VPD sum limit is '0' it is ignored.
- **Min. Time:**
  - In Rad/VPD sum and condition modes determine the minimum time allowed between irrigations.
  - Even if the Rad/VPD sum limit / condition limit has been reached irrigation will not be performed until that time has passed.
  - In clock starts the minimum time is the delay between start of a cycle until the start of the next cycle. For example if Clock Start is set to 2, the set Run Time is 30 minutes and the Min. Time is 45 minutes. The second cycle will start 15 minutes after the end of the first cycle.
- **Max. Time:** The maximum time between two subsequent cycles. This value is used to limit the time between two cycles when using dynamic irrigation triggers such as Rad/VPD Sum or the Condition program. When the specified Max. Time from the beginning of the previous cycle has elapsed; irrigation will take place regardless of the Rad/VPD Sum level or the Condition program status.



- Valve #: The Green Field ECO can operate valves in any required order. Set the valve number and press . The following window appears:

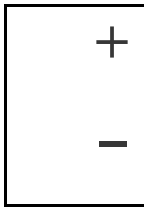

Select 'blank' and press  to set the valve to operate alone, or '+' (plus) to operate together with the next valve. Several valves can be set to work together, as a group. A valve set (group) will have the same Run Time program and the same dosing program. Each irrigation program can include a maximum of 100 valves (columns) in any required order (all of them together, one after the other, a few groups-max. 100 groups, etc.). The same valve can be entered several times with different settings.

- Run Time #: attach a Run Time Program to a valve or a group of valves. When setting valves to work individually, a Run Time Program should be set for each valve. When setting a few valves to work together ("+" mark between them) a Run Time Program should only be set for the first valve, the rest of the valves will follow this setting.

*NOTE The quantity set in the Run Time Program will be the quantity given for all valves set to operate together, not per valve (for further specifications of the Run Time Program see Water Run Time, page 58).*

- Dosing Program: Attach a Dosing Program to a valve or a group of valves. When setting valves to work individually, a Dosing Program should be set for each valve. When setting a few valves to work together (with "+" mark between them) a Dosing Program should only be set for the first valve, the rest of the valves will follow this setting.
- Day (xx/xx): Allows defining whether the program should irrigate water only, dose or be turned off on different days.
  - (xx/xx): The right setting defines the day's cycle.
  - (xx/xx): The left setting defines the current day of the cycle.

Select Dose, Water or None and press . 'Dose' means Fertigation (water + dosing), 'Water' means irrigation without dosing and 'None' means the program is idle in that day.

DATE : 1-May-12		TIME : 10:12:09	
<b>IRRIGATION PROGRAM</b>			
Program: 1	Priority: --	Const. 50%	
Start Time	07:00	12:00	16:00
Clock Start	2	1	1
Min. Time	01:00	00:30	--:--
Valve #	051+05	004+116	115 255
Run Time #	1 1	2 2	2 --2
Dosing Prog	1 1	3 3	4 4
Day: 04/06	1 2 3 4	5 6	
Dose / Water	D W - D	W D	

Dose
Water
None

The figure above shows “Day: 04/06”, meaning the number of the days in the cycle is 6, and the current day is day 4. Day 1 and 5 are set to dose, day 3 is set to irrigate water only, and on days 2, 4 and 6 the program is idle.

### 9.1.1 SETTING IRRIGATION THAT IS LONGER THAN 24 HOURS

If a cycle day is 1 and the irrigation length is over 24 hours, the irrigation will repeat itself continuously, which means continuous irrigation.

*NOTE Dosing operates according to ('D-W') for the same day and not according to the setting when the irrigation has started. If irrigation starts at 18:00 and on this day dosing is set ('D'), the irrigation crosses midnight to a day where no dosing is set ('W'), dosing stops at midnight!*

## 9.2 Influence Program

The Green Field ECO Irrigation Green Field ECO enables adjusting irrigation settings according to the following factors (labeled “Influences” on the screen):

- Solar radiation
- Amount of drainage
- Amount of fertilizer present in the drainage
- VPD
- Temperature

These Influences can adjust the following irrigation settings:

- EC
- Radiation Sum (RadS)
- Minimum Rest Time (MinT)

For example, a grower may want to increase the EC based on the Solar Radiation. Alternatively, he may want to decrease the MinT based on the drainage.

- Using the Influences
- Setting the Influences

## 9.2.1 USING THE INFLUENCES

- Set an Influence to increase or decrease the setting.
- Changes to the setting are in percentages (for example, a 10% increase in the EC level).
- Several Influences adjust the EC setting. The final adjustment amount is based on the sum total of the different Influences.
- You enter up to three points for each Influence setting. Irrigation Green Field ECO automatically calculates the curve based on these points.
- You can program up to 15 different programs (corresponding to the 15 irrigation programs)
- After configuring an Influence, you must enable it (under ACTIVE/SOURCE).

## 9.2.2 SETTING THE INFLUENCES

1. Go to *Install* > *Device Layout*.
2. Define relays as dosing channels, as required.
3. Go to *Program* > *Irrigation*.
4. Using the arrow keys, scroll down to Screen 2. The following screen appears.

DATE: 2 -Feb-12		TIME 12:52-08	
<b>IRRIGATION PROGRAM</b>			
Program: 1	Priority: --	Const.	0%
INFLUENCE		TABLE	ACTIVE/SOURCE
Radia./EC	<input checked="" type="checkbox"/>		NO
Drain/RadS	<input checked="" type="checkbox"/>		NO
Drain/MinT	<input checked="" type="checkbox"/>		NO
VPD/EC	<input checked="" type="checkbox"/>		NO
Temp/EC	<input checked="" type="checkbox"/>		NO

Screen 2 of 3 – In order to view the

5. Select an Influence.

The following sections detail each Influence.

- Radiation Influence on EC, page 59
- Drainage Influence on Target Radiation Sum, page 60
- Drain Influence on Minimum Time, page 61
- Drain Influence on Minimum Time, page 61
- VPD Influence on Target EC, page 62
- Temperature Influence on Target EC, page 63

### 9.2.2.1 Radiation Influence on EC

This function enables adjusting the EC based on solar radiation. Solar radiation increases the greenhouse temperature. Adjust the EC according to your crops' requirements.

To set the Radiation Influence:

1. In *Installation* > *Analog Input*, define a sensor as EC.
2. In *Configuration* > *Dosing Channel Configuration*, set React to EC.

3. In *Configuration* > *Dosing Configuration* > *EC Control* to Yes.
4. In *Program* > *Irrigation*, select *Radia./EC*.
5. Define the Radiation set points (w/m2).
6. Define the EC change in percentages.
7. Set *ACTIVE/SOURCE* to Yes.
8. Press **Menu** and confirm changes.
9. In *Program* > *Dosing Program*:
  - a. set the Target EC
  - b. set EC Dosing Method to Qty.

**Example:** As sunlight increases, a crop requires higher EC levels. The following screen illustrates increasing in the EC based on radiation. Since Irrigation Green Field ECO calculates the increase in EC proportionally, there will be a 7.5% increase when the radiation reaches 60 w/m2.

DATE: 2 -Feb-12		TIME 12:52-08	
IRRIGATION PROGRAM			
Program: 1	Priority: --	Const.	0%
INFLUENCE	TABLE	ACTIVE/SOURCE	
<b>Radia./EC</b>	<input checked="" type="checkbox"/>	<b>Radia.</b>	<b>EC</b>
Drain/RadS	<input checked="" type="checkbox"/>	(w/m2)	(%)
Drain/MinT	<input checked="" type="checkbox"/>	40	5
VPD/EC	<input checked="" type="checkbox"/>	100	20
Temp/EC	<input checked="" type="checkbox"/>		

Screen 2 of 3 – In order to view the

### 9.2.2.2 Drainage Influence on Target Radiation Sum

Irrigation can be triggered by the Radiation Sum (Rad Sum). This Influence enables adjusting the Rad Sum based on the amount of drainage.

To set the Drainage Influence on Rad Sum:

1. In *Program* > *Irrigation*, set *Contr.* to Rad Sum.
2. In *Installation* > *Digital Input*, define which digital input is the drain meter.

**NOTE** The drainage must be defined correctly! You can check the drainage meter status using Hot key 9.

3. In *Configuration* > *Valve Configuration* define which valve number corresponds to which drainage meter.
4. In *Configuration* > *Drainage Configuration*, define the drainage meter's Ratio Liter/Pulse.
5. In *Program* > *Irrigation*, select *Drain/RadS*.
  - a. Define the Drainage percentage set points.
  - b. Define the RadS percentage set points.
6. Set *ACTIVE/SOURCE* to Yes.
7. Press **Menu** and confirm changes.

**Example:** A user set irrigation to be triggered by the radiation sum. However, he wants to increase the gap between irrigations as drainage increases. The following illustration demonstrates how Rad Sum can increase. When drainage reaches 75%, the Rad Sum increases by 30%. If the Rad Sum Limit were set to 100, than at 75% drainage, it would increase to 130.

DATE: 2 -Feb-12		TIME 12:52-08	
IRRIGATION PROGRAM			
Program: 1	Priority: --	Const.	0%
INFLUENCE	TABLE	ACTIVE/SOURCE	
Radia./EC	<input checked="" type="checkbox"/>	DRAIN%	RadS
Drain/RadS	<input checked="" type="checkbox"/>	(%)	(%)
Drain/MinT	<input checked="" type="checkbox"/>	25	10
VPD/EC	<input checked="" type="checkbox"/>	75	30
Temp/EC	<input checked="" type="checkbox"/>		

Screen 2 of 2 - In order to view the

### 9.2.2.3 Drain Influence on Minimum Time

Minimum time defines the minimum break between irrigations. Even if the Rad/VPD sum limit / condition limit has been reached irrigation does not take place until this time has passed. This function enables adjusting the Minimum Time based on the drainage.

To set the Drainage Influence on the Minimum Time:

1. In *Installation > Digital Input*, define which digital input is the drain meter.

**NOTE** The drainage must be defined correctly! You can check the drainage meter status using Hot key 9.

2. In *Configuration > Valve Configuration* define which valve number corresponds to which drainage meter.
3. In *Configuration > Drainage Configuration*, define the drainage meter's Ratio Liter/Pulse.
4. In *Program > Irrigation*, select Drain/MinT.
  - a. Define the Drainage percentage set points.
  - b. Define the MinT percentage set points.
5. Set ACTIVE/SOURCE to Yes.
6. Press Menu and confirm changes.

**Example:** When drainage is low, a user wants to decrease the Minimum Time. He sets 20% drainage to a MinT of -25%. As drainage increases, the time between irrigation increases. In this scenario, if the MinT is set to 60 minutes, 40% drainage adjusts the time to 75 minutes.

DATE: 2 -Feb-12		TIME 12:52-08	
IRRIGATION PROGRAM			
Program: 1	Priority: --	Const.	0%
INFLUENCE	TABLE	ACTIVE/SOURCE	
Radia./EC	<input checked="" type="checkbox"/>	<b>DRAIN%</b>	<b>MinT</b>
Drain/RadS	<input checked="" type="checkbox"/>	(%)	(%)
Drain/MinT	<input checked="" type="checkbox"/>	20	-25
VPD/EC	<input checked="" type="checkbox"/>	40	25
Temp/EC	<input checked="" type="checkbox"/>		

### 9.2.2.4 VPD Influence on Target EC

You can adjust the EC based on the VPD Sum (air temperature and humidity). As the VPD rises or falls, the program can increase or decrease the EC level according to your requirements.

1. In *Installation > Analog Input*:
  - a. define a sensor as EC
  - b. define an air temperature sensor
  - c. define a humidity sensor

**NOTE** You can verify the EC status using Hot Key Screen, the temperature and humidity sensors status using Hot Key Screen 6.

2. In *Setup > VPD Sensor Setup*, enable VPD Temperature and VPD Humidity sensors.
3. In *Configuration > Dosing Channel Configuration* set React to EC.
4. In *Configuration > Dosing Configuration > EC Control*, set EC Control to Yes.
5. In *Program > Irrigation*, select VPD/EC.
  - a. Define the VPD sum points.
  - b. Define the EC percentage set points.
6. Set ACTIVE/SOURCE to Yes.
7. In *Program > Dosing Program*:
  - a. set the Target EC
  - b. set EC Dosing Method to Pr. Qty.

**Example:** A grower wants to lower the EC level as the VPD decreases. He sets this screen to reduce the increase in EC level to match the decreasing VPD levels.

DATE: 2 -Feb-12		TIME 12:52-08	
IRRIGATION PROGRAM			
Program: 1	Priority: --	Const.	0%
INFLUENCE	TABLE	ACTIVE/SOURCE	
Radia./EC	<input checked="" type="checkbox"/>	VPD	EC
Drain/RadS	<input checked="" type="checkbox"/>	(kPa)	(%)
Drain/MinT	<input checked="" type="checkbox"/>	15	7
VPD/EC	<input checked="" type="checkbox"/>	10	4
Temp/EC	<input checked="" type="checkbox"/>	5	2

### 9.2.2.5 Temperature Influence on Target EC

You can adjust the EC based on the air temperature. As the temperature rises or falls, the program can increase or decrease the EC level according to your requirements.

1. In *Installation > Analog Input*:

- a. define a sensor as EC
- b. define an air temperature sensor

You can verify the EC status using Hot Key Screen 4, the temperature sensor status using Hot Key Screen 6.

2. In *Configuration > Dosing Channel Configuration* set React to EC.

3. In *Configuration > Dosing Configuration > EC Control*, set EC Control to Yes.

4. In *Program > Irrigation*, select Temp/EC.

- a. define the Temperature sum points.
- b. define the EC percentage set points.

5. Set ACTIVE/SOURCE, select the temperature sensor number.

DATE: 2 -Feb-12		TIME 12:52-08	
IRRIGATION PROGRAM			
Program: 1	Priority: --	NO	0%
INFLUENCE	TABLE	OUT temp	
		Temp 1	
Radia./EC	<input checked="" type="checkbox"/>	Temp 2	
Drain/RadS	<input checked="" type="checkbox"/>	N/A	
Drain/MinT	<input checked="" type="checkbox"/>	NO	
VPD/EC	<input checked="" type="checkbox"/>	NO	
Temp/EC	<input checked="" type="checkbox"/>		

Screen 2 of 3 - In order to view the

6. In *Program > Dosing Program*:

- a. set the Target EC
- b. set EC Dosing Method to Pr. Qty.

Example: A grower's flower crop requires higher EC levels when the temperature goes above room temperature (22° C). Using this screen, he can adjust the levels accordingly.

DATE: 2 -Feb-12		TIME 12:52-08	
IRRIGATION PROGRAM			
Program: 1	Priority: --	Const.	0%
INFLUENCE	PRIORITY	ACTIVE/SOURCE	
Radia./EC	<input checked="" type="checkbox"/>	Temp	EC
Drain/RadS	<input checked="" type="checkbox"/>	(°C/F))	(%)
Drain/MinT	<input checked="" type="checkbox"/>	25	2
VPD/EC	<input checked="" type="checkbox"/>	27	5
<b>Temp/EC</b>	<input checked="" type="checkbox"/>	30	7

### 9.3 Water Run Time

WATER RUN TIME PROGRAM				
#	Method	Water	Before	After
1	QTY.	11.000	0.300	0.400
2	TIME	01:05:00	00:10:00	00:16:00
3	QTY.	3.000	0.000	0.000
4	QTY.	5.000	0.000	0.000
5	QTY.	6.000	0.000	0.000
6	QTY.	8.000	0.000	0.000
7	QTY.	11.000	0.000	0.000
8	QTY.	12.000	0.000	0.000
9	QTY.	13.000	0.000	0.000
10	QTY.	14.000	0.000	0.000
11	QTY.	16.000	0.000	0.000

The WATER RUN TIME table has 60 “floating” programs; each program can be configured so that irrigation water is given in time (HH:MM:SS) or in quantity (m<sup>3</sup> or gallon, depending on definitions in the System Setup, page 79). The programs can later be connected to a valve or a group of valves through the Irrigation Program. Each program includes water, water before and water after settings.

- Method: Select the method (QTY. Or Time) with the up/down arrow keys and press



to confirm.

- Water: Set quantity / time for each program (liter or gallon). The water setting is the total quantity / time including the Before and After settings.
- Before: Set quantity/time without dosing at the beginning of each irrigation cycle.
- After: Set quantity/time without dosing at the end of each irrigation cycle.

**NOTE** Before and After settings are deducted from the Water settings. Therefore Water quantity/time must be greater than or equal to the Before and After settings.



## 9.4 Dosing

DOSING PROGRAM				
Program: 1				
INJECTION PER DOSING CHANNEL				
1	2	3	4	—
EC	EC	ACID	PASSIV	—
3.00	5.00	6.00	5.00	—
Target EC			2.00	
Target PH			6.00	
Passive Dosing Method			QTY	
EC Dosing Method			P.QTY	
PH Dosing Method			P.QTY	

Green Field ECO includes 10 predefined dosing programs. Each program consists of injection methods, quantities, and EC/pH target values. Each channel is completely independent and can be set to give a different amount. Overlapping between the various channels is possible.

- Dosing Program
- Dosing Injection Methods

### 9.4.1 DOSING PROGRAM

- Program: Select a program by entering the program number and confirm by

pressing .

#### INJECTION PER DOSING CHANNEL

- Dosing channel number: 1 to 8.
- Reaction: A read only line indicating the purpose of the channel.
  - EC: the channel is used to increase measured EC, meaning it will be opened more when the measured EC is lower than the set EC.
  - pH: the channel is used to decrease measured pH, meaning it will be opened more when the measured pH is higher than the set pH.
  - Passive: the channel does not respond to changes in measured EC/pH, meaning it will be opened as set in the Dosing program regardless of the EC/pH values.
  - Alkali: the channel is used to increase measured pH, meaning it will be opened more when the measured pH is lower than the set pH.
- Quantity / Time: Set the Quantity / Time to be injected for each dosing channel. The injection method (proportional, quantity, time, etc.) can be set separately for each use of the channel (EC, pH, Passive).
- Target EC: Set the required EC target value, only visible if EC control or EC alarms are active, see table 1.3.
- Target pH: Set the required pH target value, only visible if pH control or pH alarms are active, see table 1.3.
- Passive Dosing Method: Set the required injection method of the Passive dosing channels (see Dosing injection method).

- EC Dosing Method: Set the required injection method of the EC dosing channels (see Dosing injection method).
- pH Dosing Method: Set the required injection method of the Acid and Alkali dosing channels (see [Dosing injection method](#)).

#### 9.4.2 DOSING INJECTION METHODS

- **P.Qty (1/1000):** Proportional quantity. Each dosing channel can be set to give a different amount. The set amount is 1 part (Liter or Gallon) fertilizer/Acid per 1000 parts (m<sup>3</sup>/h or 1000 Gallons) of water.

For example:

- Channel 1 is set to 5.0 (liters or gallons).
- Set water quantity is 3.5 (m<sup>3</sup>/h or 1000 gallons).

This setting actually means that 5.0 (liters or gallons) of fertilizer will be mixed with each cubic meter (1000 gallons respectively) of water passing through the system.

The total quantity of fertilizer that will be given is  $5.0 * 3.5 = 17.5$  liters (Gallons).

- **P.Time (hh:mm):** Proportional time. Each dosing channel is given the time to fertilize independently. The Green Field ECO divides this time equally within the given irrigation time (quantity) set in [1.2 WATER RUN TIME](#).

For example:

- Dosing channel 1 is set to 00:10; Dosing channel 2 is set to 01:00.
- Set irrigation time is 03:00 hours.

The Green Field ECO will proportionally divide the set fertigation time for each dosing channel across the set irrigation time (quantity).

Dosing channel -1- will be on for a few pulses; their total time will be 10 min. Dosing channel -2- will be on for a few pulses (not necessarily the same amount). Their total time will be 60 min.

- **Time. (hh:mm):** Each dosing channel is given the time to fertigate. Dosing will be done in one bulk that will start after water, before time/quantity has elapsed.
- **Qty. (Liters or Gallons):** Quantity. Each dosing channel is given the amount to be injected. Dosing will be done in one bulk or spread throughout the irrigation, depending on settings in the screen [7.7 DOSING CONFIGURATION](#), line [Dosing by QTY. Method](#). Dosing will start after water, before time/quantity has elapsed.

To choose a method, place the cursor on the METHOD column and press



A small window will appear:

DOSING PROGRAM				
Program:	1			
INJECTION PER DOSING CHANNEL				
1	2	3	4	---
EC	EC	ACID	PASSIV	---
3.00	5.00	6.00	5.00	
Target EC			2.00	
Target PH		<b>P. QTY</b>	6.00	
Passive Dosing Me		<b>P. TIME</b>	QTY	
EC Dosing Method		<b>TIME</b>	P.QTY	
PH Dosing Method		<b>QTY.</b>	P.QTY	



Select the method with the arrow keys and press  to confirm.

*NOTE* The EC/pH columns will not be visible if EC/pH control and EC/pH alarms are marked 'No'.

### 9.5 Ext. Condition

The Ext Condition program allows starting and/or stopping irrigation according to dry contacts or analog sensor. In addition, it is possible to define an output called Cond. This output will be active whenever the condition program settings are met. This enables using the condition program to start any external device.

Refer to Analog Input , page 27 for details on configuring this window.

EXTERNAL CONDITION PROGRAM			
#	From hh:mm	To hh:mm	Dry Cont.
1	10:00	12:00	Dry Con 1
2	11:00	12:00	Dry Con 1
3	12:00	13:00	<NONE>
4	--:--	--:--	<NONE>
5	--:--	--:--	<NONE>
6	--:--	--:--	<NONE>
7	--:--	--:--	<NONE>
8	--:--	--:--	<NONE>

- From (hh:mm): Set the start time of the condition program.
- To (hh:mm): Set the end time of the condition program

The condition program will only be operational in the defined time window (between start "From" to end "To" times). Each condition program can be operational at different hours.

- Trigger Type: Choose one of three trigger types:
  - One Shot: If the Start Dry Contact is closed for more than 20 seconds the associated irrigation program will be started. The contact must open and close to initiate irrigation.
  - Multi shot: If the Start Dry Contact is closed for more than 20 seconds the associated irrigation program will be started. If the contact is still closed when the irrigation has finished, irrigation will be initiated.

*NOTE Notice that the Start Dry Contact does not necessarily have to open and close in order to initiate irrigation. It simply has to be closed when the irrigation has finished.*

- Only If On: The associated Irrigation program will be turned on, providing the Start Dry Contact has been closed for more than 20 second and will remain on as long as the contact is closed.

The following is a description graph of the Condition program:

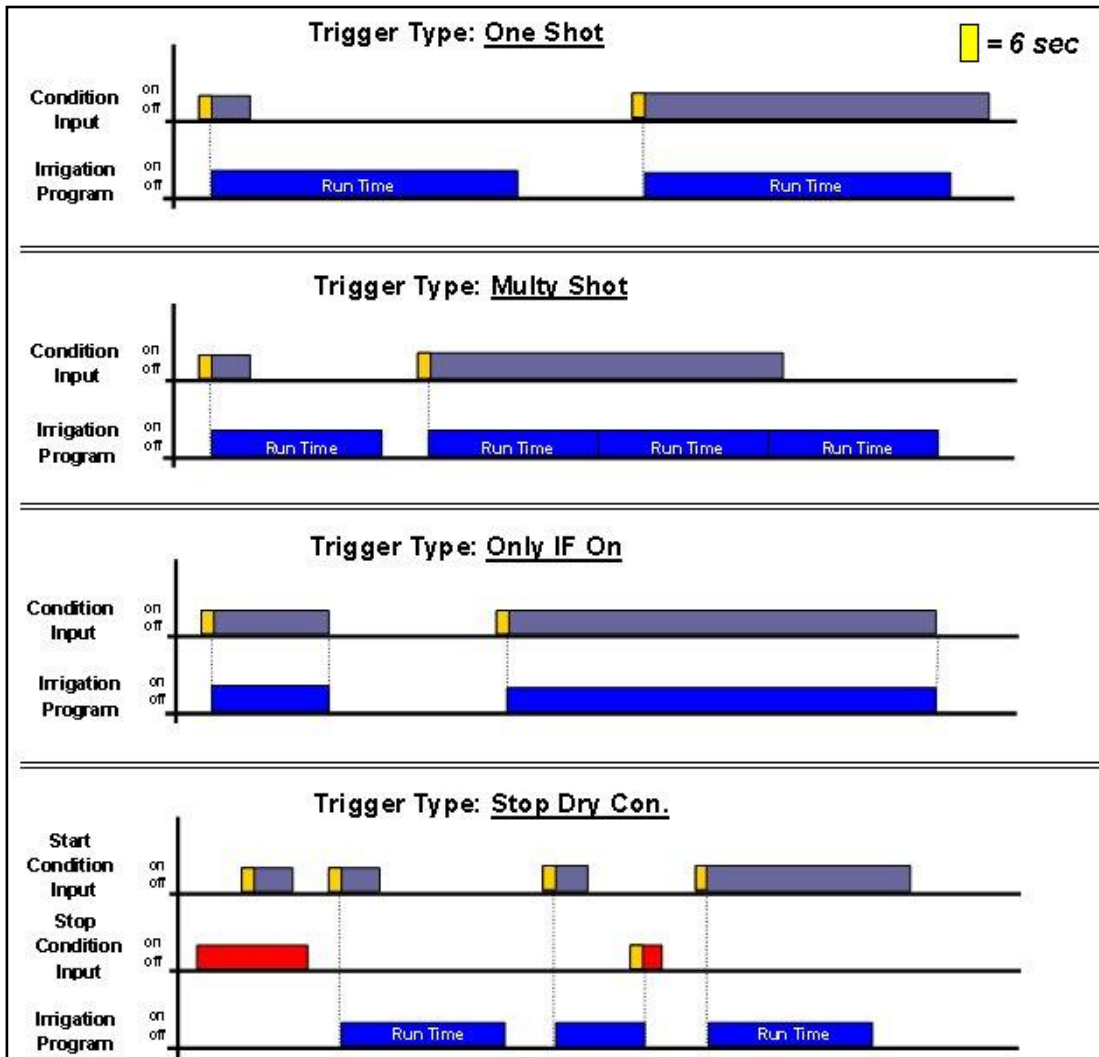

## 9.6 Agitator

The agitator is used to mix the fertilizers and acid in the storage tanks in order to prevent the occurrence of sediment.

AGITATOR		
	On	Off
	mm:ss	mm:ss
Dosing Active	01:00	10:00
Dosing Not Active	02:00	30:00

- **Dosing Active:** Definition of the On and Off times of the agitator when dosing is taking place:
  - **On:** Define the required mixing time.
  - **Off:** Define the required time between mixing.
- **Dosing Not Active:** definition of the On and Off times of the agitator when dosing is not taking place:
  - **On:** Define the required mixing time.
  - **Off:** Define the required time between mixing.

## 9.7 Selector

This screen enables the use of various fertilizer stock tanks. Every dosing program can be connected to one (or more) selectors. Using the selector outputs you can choose which fertilizer stock will be connected to each dosing program.

SELECTOR					
Dosing Prog.	S1	S2	S3	S4	S5
1	✓	•	•	•	•
2	•	✓	•	•	•
3	•	•	✓	•	•
4	•	•	•	✓	•
5	•	•	•	•	✓
6	✓	•	•	•	•
7	•	✓	•	•	•
8	•	•	✓	•	•
9	•	•	•	✓	•
10	•	•	•	•	✓

Use the '+/-' keys to assign a selector to a dosing program.

## 9.8 Filter Flushing

Configuring the required process for filter flushing is allowed. Define the following before configuring this screen:

- Stop Irrigation During Filter Flushing: Yes/No
- Stop Dosing During Filter Flushing: Yes/No

FILTER FLUSHING PROGRAM	
Time Between Flushing (hh:mm)	06:00
Flushing Time (mm:ss)	01:00
Delay Between Filters (mm:ss)	00:30
Delta Pressure (Digital)	YES
Delay Delta Pressure (mm:ss)	00:06
Delta Pressure Reiteration	3
Dwell Time Main (mm:ss)	01:00

- **Time Between Flushing (hh:mm):** Time interval between two consecutive Flushing cycles. The time is only counted during irrigation.  
Example: If the time between flushing is set to 01:00 it means that a flushing cycle

will be activated after 1 hour of irrigation (regardless of DP status).  
 If set to zero (---:--), flushing will only take place if triggered by a DP.

- **Flushing Time (mm:ss):** Flushing time of each Filter (output).
- **Delay Between Filters (mm:ss):** The delay time between flushing of one filter to the next. This time is usually used to allow pressure buildup.
- **Delta Pressure (Digital):** Define whether filter flushing can be triggered due to digital Delta Pressure (Yes / No).
- **Delay Delta Pressure (mm:ss):** Define the time that the Delta Pressure (digital or value) must be active before a filter flushing cycle will be triggered. This time is usually used to prevent unnecessary flushes from taking place.
- **Delta Pressure Reiteration:** Number of consecutive filter flushing cycles triggered by the Delta Pressure that can take place without any breaks, before the Green Field ECO will generate an alarm indicating that the Delta pressure sensor is defective. The Green Field ECO will then ignore the Delta Pressure and will continue flushing according to the set Time Between Flushing only, until the alarm is reset.
- **Dwell Time Main Filter Valve (mm:ss):** Define for how much time the main filter valve must be on before the filter flushing cycle is started. This output is typically used to control a pressure-sustaining valve or to start a booster pump.

## 9.9 Cooling

The Cooling/Humidification program is used to keep the temperature below a set value and/or the humidity above a set value. Each program can be set to maintain temperature or humidity as its first priority.

Five Cooling programs are available with two periods in each program. The periods can be defined to overlap, thus creating “dynamic” cooling or humidification.

Different temperature and humidity sensors can be connected to each program.

The *Status* can be defined as *Cooling* or *Humidification*, the aim of the status field is to help the user to understand the process that should take place by placing the related set point first (i.e. *above t°* when the *status* is *cooling* OR *bellow RH* when the *status* is *Humidification*)

**NOTE** There are a few steps that should be defined prior to this screen: see *Cooling Configuration*.

COOLING/HUMIDIFICATION PROGRAM						
Program: 1		Status: Cooling				
	From	To	Above t°			
1	08:00	16:00	30.0			
2	08:00	16:00	40.0			
Cool #	1	2	--	--	--	--
Temp. Sens. :	1	--	Hum. Sens: 1			

COOLING/HUMIDIFICATION PROGRAM						
Program: 1		Status: Cooling				
	To	Above t°	Below RH			
1	16:00	30.0	80			
2	16:00	40.0	80			
Cool #	1	2	--	--	--	--
Temp. Sens. :	1	--	Hum. Sens: 1			

COOLING/HUMIDIFICATION PROGRAM						
Program: 1	Status: Cooling					
	Below PH	On	Off			
1	80	00:00:30	00:03:00			
2	80	00:00:30	00:01:00			
Cool #	1	2	--	--	--	--
Temp. Sens.:	1	--	Hum. Sens: 1			

- Program: Choose the required program 1 to 8, press  to confirm.
- Status: define whether the program's first priority is maintaining temperature or humidity.
- Cooling: the program's priority is temperature. If the two periods are overlapping and there are different settings in each period, dynamic cooling will take place.

#### Example:

- Settings:
  - Period 1 is set between 08:00 to 16:00. The cooling process should work above temp. of 30°C and Below RH of 80%.
  - Period 2 is set between 08:00 to 16:00. The cooling process should work above temp. of 40°C and Below RH of 80%
  - On time is fixed to 30 sec in both periods.
  - Off time is 3:00 minutes which relates to the lowest temperature setting (30°C)
  - Off time is 1:00 minute which relates to the highest temperature setting (40°C)
- Scenarios:
  - Time is 10:00, the measured temperature is 35°C and the measured relative humidity is 65%, the cooling valve will be open for 30 seconds and close for 2:00 minutes in a continuous cycle.
  - Time is 12:00, the measured temperature is 30°C and the measured relative humidity is 65%, the cooling valve will be open for 30 seconds and close for 3:00 minutes in a continuous cycle.
  - Time is 14:00, the measured temperature is 40°C and the measured relative humidity is 50%, the cooling valve will be open for 30 seconds and close for 1:00 minutes in a continuous cycle.
  - Time is 15:00, the measured temperature is 35°C and the measured relative humidity is 85%, the cooling valve will not be open since the measured relative humidity is above the maximum allowed (80%).

**NOTE** If more than one cooling valve is defined, the off time will take place after the last valve in the sequence (Cooling valve #2, in the above screen). Between the cooling valves there is no delay and they are working in sequence, from the first valve on the left side to the last one.

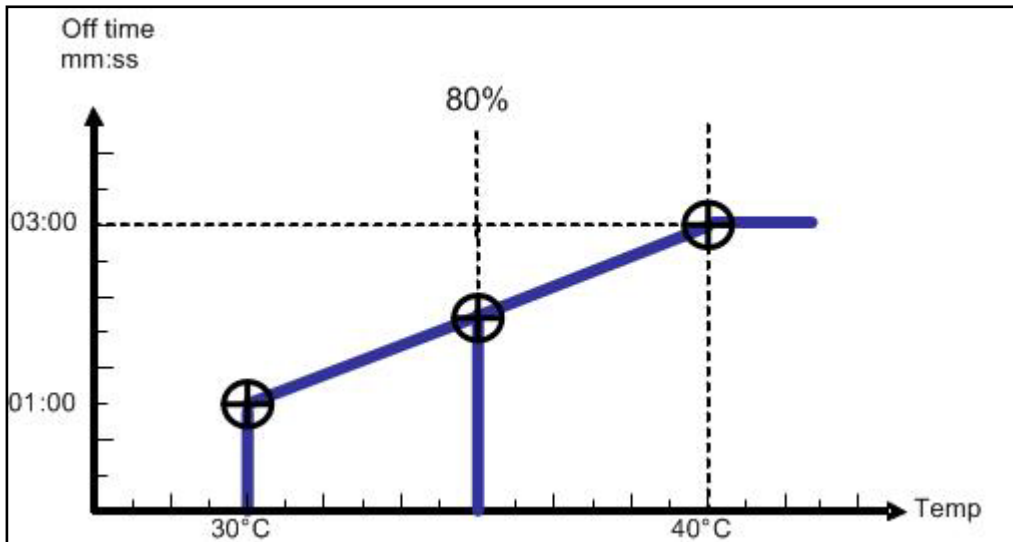

**NOTE** If the time is relevant only for a certain period, only its settings will define operation. If humidity is above the lowest value of the two periods, cooling will not take place.

- From (hh:mm): Set the start time of the Cooling / Humidification program.
- To (hh:mm): Set the end time of the Cooling / Humidification program

**NOTE** The program will only be operational in the defined time window (between start "From" to end "To" times). Each program can be operational at different hours.

- Above t° / Below RH
  - Above t° (when status is cooling): Start cooling above this temperature. Cooling will stop if the temperature drops below the internal dead-band of 0.5°C. For example if set to 30°C cooling will start when the temperature is above 30°C and will stop when it drops below 29.5°C. °
  - Below RH (when status is humidification): Start humidification below this humidity. Humidification will stop if the humidity goes above the internal dead-band of 1%. For example, if set to 80% humidification will start when the humidity is below 80% and will stop when it is above 81%.
- Below RH / Above t°
  - Below RH (when status is cooling): Stop cooling above this humidity. Cooling will be resumed when the humidity drops below the internal dead-band of 2%. For example, if set to 80% cooling will stop when the humidity is above 82% and will be resumed when the humidity drops below 80%.
  - Above to (when status is humidification): Stop humidification when the temperature is below this temperature. Humidification will be resumed when the temperature goes above the internal dead-band of 0.5°C. For example, if set to 25°C humidification will stop when the temperature drops below 24.5°C and will be resumed when it goes above 25°C.
- On (hh:mm:ss): Define the On time of the Cooling valve. If On time is set to zero, the Cooling valve will not be opened.
- Off (hh:mm:ss): Define the Off time of the Cooling valve. If Off time is set to zero, the Cooling valve will be constantly On.
- Cool #: Assign cooling valves to this program. The assigned cooling valves will be operated sequentially in groups. The number of groups (different cooling



programs) which can be operated simultaneously (maximum cooling parallel) is defined in screen [6.2 SYSTEM SETUP](#).

- Temp. Sens.: Assign Up to two temperature sensors for this program.
- Hum. Sens.: Assign up to two humidity sensors to this program.

If there is a malfunction in one of the temperature sensors, a message will be displayed, and that sensor will be taken out of the average temperature calculation. If all the temperature sensors are out of order, the controller will operate according to the first active line. If you would like to operate the program by time only, set as follows:

Set Status to cooling or humidification (not important). Set the Above t°. and Below RH to '0'. Define the required On and Off times and the program will work accordingly within the set time frame.

## 9.10 Misting

The misting program is a time scheduler used to open/close a misting valve or any other device that is operated sequentially. Up to 40 misting programs can be preset.

Note that there are a few steps that should be defined prior to this screen, see the Misting Configuration Table on page 45.

MISTING PROGRAM					
#	No.	Start hh:mm	End hh:mm	On hh:mm:ss	Off hh:mm:ss
1	1	08:00	18:00	00:00:30	00:10:00
2	2	10:00	19:00	00:00:50	00:13:00
3	3	11:00	18:00	00:01:00	00:16:00
4	4	08:00	13:00	00:00:55	00:20:00
5	5	09:00	20:00	00:00:18	00:30:00
6	6	10:00	00:00	00:01:02	00:15:00
7	7	--:--	--:--	--:--:--	--:--:--
8	8	--:--	--:--	--:--:--	--:--:--
9	9	--:--	--:--	--:--:--	--:--:--
10	10	--:--	--:--	--:--:--	--:--:--

- Mist No.: Assign a mist valve to the program. It is possible to associate the same misting valve with several programs.
- Start (hh:mm): Set the start time of the Misting program. If start time is set to 00:00, it will automatically be changed to --:--, meaning the program is not operational.
- End (hh:mm): Set the end time of the Misting program. The Misting program will only be operational in the defined time window (between Start to End times). Each Misting program can be operational at different hours.
- On: Define the On time of the misting valve. If On time is set to zero the MISTING valve will not be opened.
- Off: Define the Off time of the MISTING valve. If Off time is set to zero the MISTING valve will be constantly On.

The table is sorted according to mist number as the first priority and start time as the second priority. The Mist No. will always appear in groups in an increasing order so that the orientation is quick and easy.

Each mist group has an inside start time sorting, so that a later start is moved to the end of the group. If you delete a row (by zeroing the Mist .No.) it will be moved to the end of the

table and the rest of the rows will move one step up. Pressing the menu key does this sorting.

*NOTE When misting is on all related devices (e.g. misting valve, main valve, and pump) are operational. When misting is off, only the pump continues to operate*

## 9.11 Water Heating

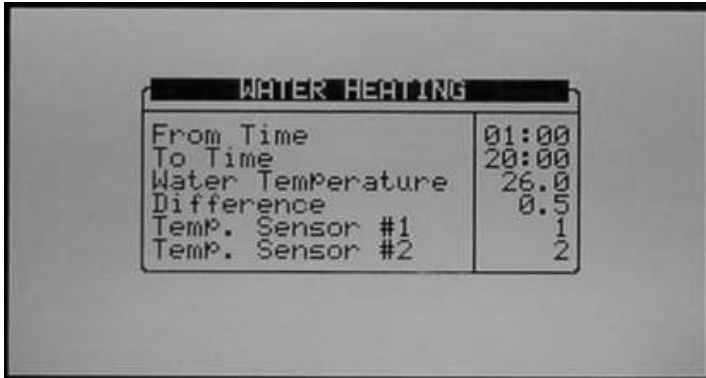

WATER HEATING	
From Time	01:00
To Time	20:00
Water Temperature	26.0
Difference	0.5
Temp. Sensor #1	1
Temp. Sensor #2	2

Water Heating operates according to temperature within a set time frame (between start “From Time” to end “To Time”) and can be used to increase irrigation water temperature or prevent frost.

- **From Time (hh:mm):** Set the start time of the water-heating program.
- **To Time (hh:mm):** Set the end time of the water-heating program.
- **Water Temperature:** Water heating will be activated when the temperature drops below this value.
- **Difference:** Dead-band for stopping water heating. When the water temperature reaches the set Water Temperature + Difference, water heating will be stopped.

For Example: Water temperature is 25°C and the difference is 2°C. Water heating will start when the temperature drops below 25°C and will stop when it is 27°C or above. The Minimum difference is 0.3°C and the default is 0.5°C.

- **Temp. Sensor 1/2:** Assign up to 2 temperature sensors. If you assign 2 sensors, the Green Field ECO will operate according to their average.

# 10 Manual Operation Menu

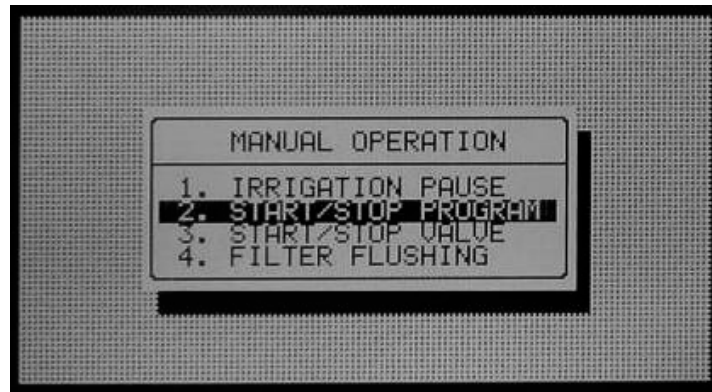

- Irrigation Pause, page 75
- Start/Stop Program, page 76
- Start/Stop Valve, page 76
- Filter Flushing, page 77

## 10.1 Irrigation Pause

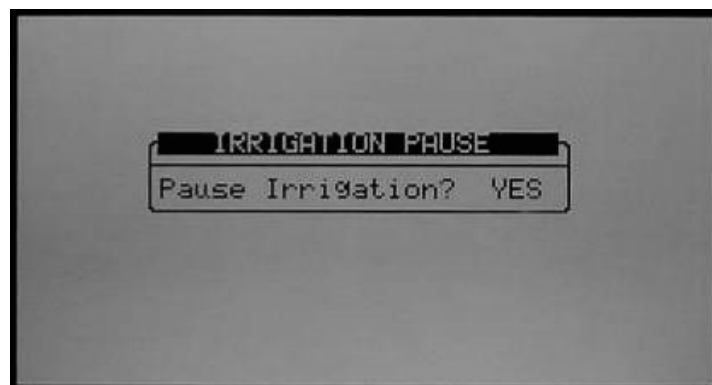

- Pause Irrigation (Yes/No): Set Yes and press  to confirm; all irrigations will be paused until the value will be set back to No. When the system is released from Pause mode it will complete all irrigations that should have taken place when it was paused.

## 10.2 Start/Stop Program



1. Enter a program number to start and press .

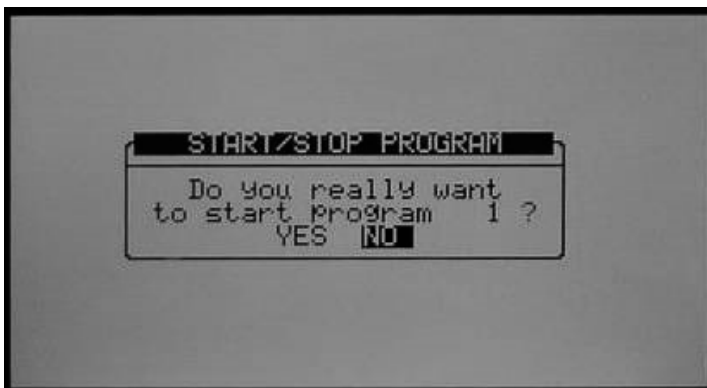

2. Select 'Yes' to confirm your choice and start the relevant program.

3. When you enter the Start/Stop screen during irrigation you will be asked whether you wish to stop the active program. Choose Yes to stop the program.

## 10.3 Start/Stop Valve

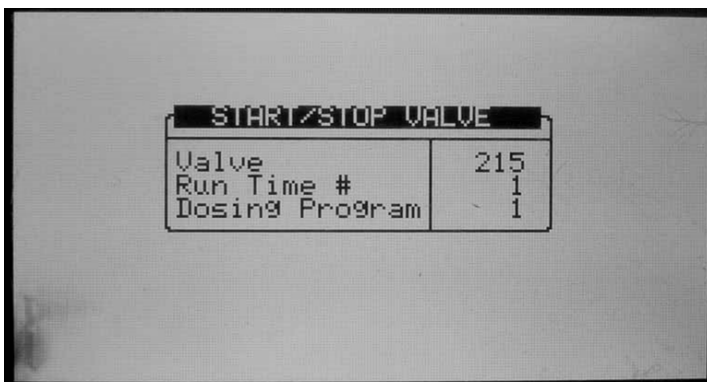

1. Enter a valve number, Run Time program and (optional) dosing program,

press  to confirm and then press the menu button to open the confirmation screen.



2. Select 'Yes' if you wish to start the relevant valve.
3. When you enter the Start/Stop screen and a valve is active you will be asked whether you wish to stop the relevant valve. Choose Yes to stop the valve.

#### 10.4 Filter Flushing

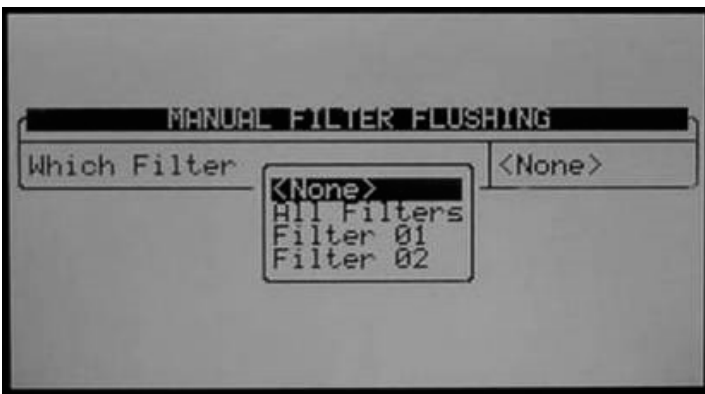

To flush filters manually, follow the prompts, select which filters to flush with the arrow keys and press  to confirm. You can flush all filters or individual filters (without Pump or Main valve operation).

# 11 Setup Menu

The Setup Menu provides clock, calibration, plug storage/retrieval, and language settings.

- Time and Date
- System Setup
- Temperature Calibration
- Humidity Calibration
- EC/pH Calibration
- Sensors Logging
- Write to Data Plug
- Read from Gold Data Plug

## 11.1 Time and Date

SETUP
1. TIME & DATE
2. SYSTEM SETUP
3. TEMPERATURE CALIBRATION
4. HUMIDITY CALIBRATION
5. EC/PH CALIBRATION
6. SENSOR LOGGING
7. WRITE TO DATA PLUG
8. READ FROM DATA PLUG

TIME & DATE	
Current Time	05:45:32
Date	9-Feb --13
End Day Time	014
Start Time for VPD Sum	08:00
End Time for VPD Sum	12:00

*NOTE* In any given menu, you may use arrow and ENTER keys on touch pad to make a selection or press the corresponding number and ENTER on touch pad as a short cut.

The Time & Date screen allows you to set the current time and date as well as the end of the crop daytime.

To adjust the time and date, place the cursor on the setting you wish to modify, change the numbers using the keypad and press  to save your changes.

- **End Day Time:** Select the start time of a new day 00:00 to 23:00. At End Day time:
  - All the alarms are reset.
  - All the uncompleted irrigations are reset.
  - All the valves that are registered in the uncompleted programs table and did not complete the irrigation are switched from Wait position to Do Not Continue (Move to history).

- Cycle days in the PROGRAM table are moved one day ahead.
- The daily % change is zeroed (the constant % change stays the same).
- Currently active cycle will continue with its current settings until completed.
- **Start/End time for VPD Sum** – Set the time frame for the VPD Sum counter.
  - Only during this time frame will the VPD be summed
  - At End time for VPD Sum, the counter is reset

## 11.2 System Setup

The System Setup screen includes all general system settings.

SYSTEM SETUP	
<b>Language</b>	ENGLISH
Temperature Unit	C°
Volume Unit	METRIC
<b>Maximum Cooling Parallel</b>	1
<b>Maximum Misting Parallel</b>	1
<b>STOP IRRIGATION</b>	
<b>During Filter Flushing</b>	NO
<b>During Cooling Process</b>	NO
<b>During Misting Process</b>	NO
<b>STOP DOSING</b>	
<b>During Filter Flushing</b>	NO
MAIN SCREEN	
Default Hotkey Number	1

SYSTEM SETUP	
HISTORY	
<b>History Resolution</b>	1 HOUR
<b>WEATHER STATION</b>	
<b>Controller Function</b>	LOCAL
OPERATION MODE	
<b>Automatic return to RO mode</b>	NO
<b>Return period to RO mode</b>	00:10
<b>COMMUNICATION</b>	
<b>Controller Number</b>	1
<b>Port Protocol</b>	GREEN NET
<b>Baud Rate</b>	9600
<b>WATER SOURCE</b>	
<b>Flow Rate – Start From</b>	ZERO

- **Language:** Choose controller language.
- **Temperature Unit:** Celsius or Fahrenheit.
- **Volume Unit:** Metric (m3 & Liter) or Gallon. These units also influence the pressure measurement units; when choosing metric pressure, measurement will be in bar, when choosing gallon pressure, measurement will be in PSI.
- **Maximum Cooling Parallel:** Define the maximum number of cooling programs to be operated simultaneously. The maximal possible number is 8.

*NOTE This number refers to the number of cooling programs that will be operated in parallel; valves from the same cooling program will always be operated sequentially.*

- **Maximum Misting Parallel:** Define the maximum number of misting valves to be operated simultaneously. The maximal possible number is 40.

## STOP IRRIGATION

- **During Filter Flushing:** Define whether irrigation should be stopped during filter flushing.
- **During Cooling Process:** Define whether irrigation should be stopped during cooling.
- **During Misting Process:** Define whether irrigation should be stopped during misting.

## STOP DOSING

- **During Filter Flushing:** Define whether dosing should be stopped during filter flushing.

## MAIN SCREEN

- **Default Hotkey Number:** Define the required default hotkey number. When the system is idle for a few minutes the controller will automatically switch to the default hotkey (hot-screen)

## HISTORY

- **History Resolution:** Set the history collection rate of the sensors. For example if set to 15 minutes, the controller will collect data from the defined sensors every 15 minutes (see 11.6 Sensors Logging for configuring which sensors / data is collected).

## WEATHER STATION

- **Controller function:** Define whether this controller is connected to a weather station directly or through the network.
  - **Local:** A weather station is connected to this controller; its data is used locally only and should not be passed or received through the network.
  - **Slave:** This controller receives weather station data through the network; the data is collected by another Green Field ECO (or Greenhouse Climate), which is connected directly to a weather station defined as Master. Sensors connected directly to a slave controller will be used by it and will have a higher priority than those transmitted by the master.

## OPERATION MODE

- **Automatic return to RO mode:** Define if the controller will return automatically back to the Read Only mode after a certain period of time.
- **Return Period to Read Only mode:** Set the amount of time for the controller to return automatically to the Read Only mode (mm:ss).  
*This parameter is only relevant if the Automatic return to RO mode parameter is defined as YES*

## COMMUNICATION

- **Controller Number:** Select the controller number for communication. The controller number in the controller and in the PC should match in order for the



communication to work. Each controller in the network must have a unique number.

## WATER SOURCE

- **Flow Rate – Start From:** Select whether the flow rate calculation in an irrigation will begin either with the value Zero (which means that the flow rate will increase according to pulses received), or a Nominal value calculated using all the active valves in the irrigation. The calculation method is important primarily for dosing and EC/pH control. When using a controller which operates with relatively slow pulses, it is recommended to choose the Nominal flow rate option due to inaccurate flow calculation in the first stage of the irrigation. When operating with slow pulses and starting with a Zero value, it will take a long time for the controller to reach its' actual flow rate value. When operating by fast pulses, choose either Zero or Nominal.
- **Calculated Flow Delay:** This parameter is relevant only when Nominal is being selected in the previous parameter. This parameter defines the time the controller uses its' nominal flow rate value before switching to the calculated one. In this period LOW FLOW and HIGH FLOW alarms will not be detected.

*NOTE To enable this parameter, set the Water Meter to Water Source. Refer to Water Meter, page 40.*

### 11.3 Temperature Calibration

This menu enables calibrating temperature sensors. Use the Left/right arrow keys to increase/decrease the values. Munters recommends calibrating the temperature sensors using a reference sensor.

TEMPERATURE		
Sensor	Temp	Factor
1	22.8	0.0
2	N/A	---

### 11.4 Humidity Calibration

This menu enables calibrating humidity sensors. Use the Left/right arrow keys to increase/decrease the values Munters recommends calibrating the humidity sensors using a reference sensor.

## 11.5 EC/pH Calibration

Calibration of EC & PH is comprised of two steps:

- Calibration of the EC/pH Monitor Transmitter, page 82
- EC/pH Transmitter Monitor & Green Field ECO Correlation, page 85

### 11.5.1 CALIBRATION OF THE EC/PH MONITOR TRANSMITTER

Use the following instructions when using the EC/pH transmitters. When using other types of transmitters use calibration guidelines supplied by the manufacturer and jump to EC/pH Transmitter Monitor & Green Field ECO Correlation.

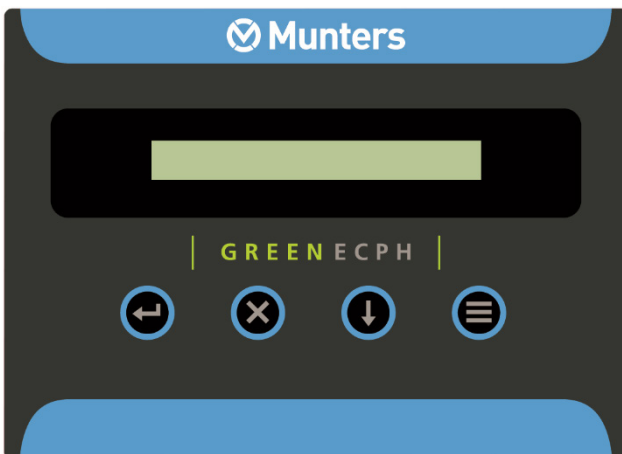

EC & PH main screen



#### 11.5.1.1 EC Calibration

- Auto Set EC (EC factory set)
- EC Soft Calibration

##### 11.5.1.1.1 Auto Set EC (EC factory set)







The Auto set procedure initializes all the previous corrections and sets the calibration according to the factory settings.

Perform Auto set on the first run and when you replace an EC Electrode with a new one.

1. Press the  button and wait for the Service prompt to appear.
2. Press  button several times until AUTOSSET EC prompt is displayed and then press . The message OK is displayed for a while and then the display reverts back to normal.

**NOTE** Always perform EC Soft Calibration after the Auto set EC (EC factor set)

### 11.5.1.1.2 EC Soft Calibration

1. Press  and wait for the Service prompt to appear.
2. Press  several times until the CALIB (rate) EC prompt is displayed and press .
3. Use  to choose EC 1.4 or EC 5, according to your water value and the buffers you have, press  to confirm.
4. Insert the probe into the appropriate buffer, wait for approximately 10 seconds, and press . You will be asked to wait for a few seconds, while the unit performs the value correction.
5. The Gain point is now set and EC 0.0 will be displayed. Hold the EC probe out in the open air and wipe it gently with a napkin or a tissue, then press .
6. If the calibration process is completed successfully, *EC Calibration OK* is displayed. If it fails, *EC CALIBRATION FAIL* is displayed, in this case refer to Green Field ECO Irrigation – Part 2 > EC/pH > Troubleshooting.

### 11.5.1.2 pH Calibration



- Auto Set pH (pH Factory set)
- pH Soft Calibration

#### 11.5.1.2.1 Auto Set pH (pH Factory set)

The Auto set procedure initializes all the previous corrections and sets the calibration according to the factory settings.

Perform Auto set on the first run and when you replace a pH electrode with a new one.

1. Press  and wait for the Service prompt to appear.

2. Press  several times until AUTOSET pH is displayed and press . The message OK is displayed for a while and then the display reverts back to normal.

*NOTE Always perform pH Soft Calibration after the Auto set pH (pH factory set)*

#### 11.5.1.2.2 pH Soft Calibration

1. Remove the pH probe and clean it by directing a stream of water towards its membrane. Do not wipe or dry the membrane.

2. Press  and wait for the Service prompt to appear.

3. Press  several times until the CALIB (rate) pH prompt is displayed and then

- press .

4. When pH 7.0 is displayed, immerse the probe in the pH 7.0 buffer, wait for

approximately 10 seconds and press . You will be asked to wait for a few seconds, while the unit performs the value correction. The Gain point is now set.

5. When pH 4.0 is displayed, immerse the probe in the pH 4.0 buffer, wait for

approximately 30 seconds and press . You will be asked to wait for a few seconds, while the unit performs the value correction. The Offset point is now set.

6. If the calibration process is completed successfully, pH Calibration OK will be displayed. If it fails, LOQUID IS POOR is displayed, please refer to Green Field ECO Irrigation – Part 2 > EC/pH > Troubleshooting.

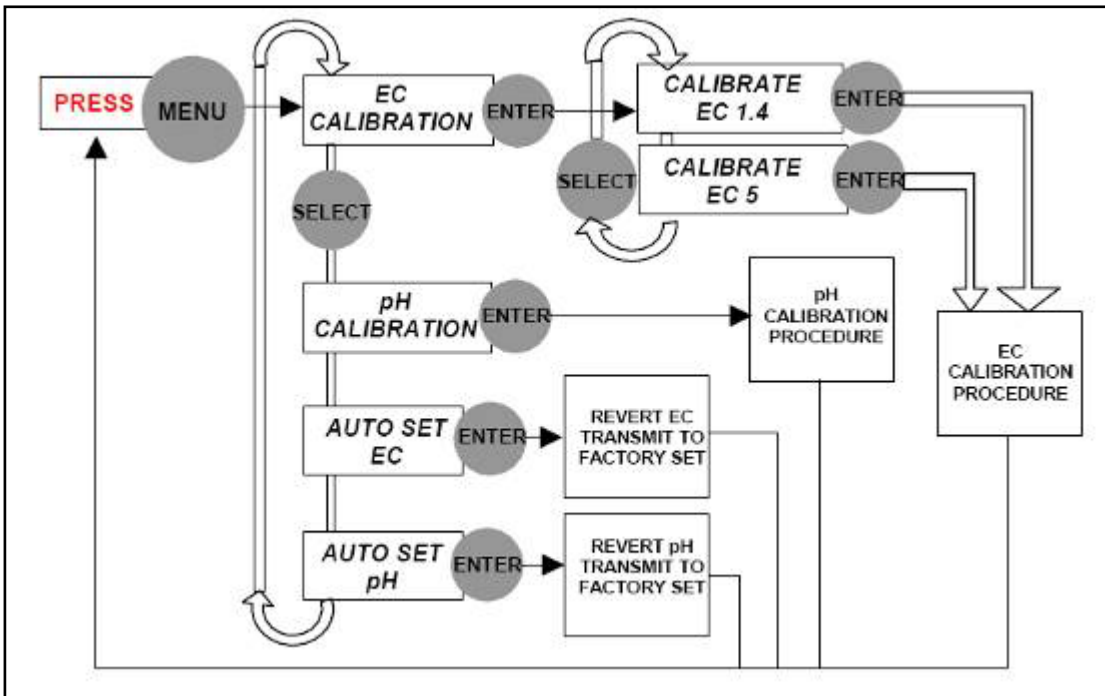

Menu Navigation Schema

### 11.5.2 EC/pH TRANSMITTER MONITOR & GREEN FIELD ECO CORRELATION

EC/pH CALIBRATION		
Sensor	Value	Factor
EC 1	1.71	0.06
pH 1	2.36	0.07
EC 2	<NONE>	---
pH 2	<NONE>	---

Press < - > Arrows to Increase/Decrease

Place the cursor on the relevant factor and use the left/right arrow keys to increase/decrease the factor until the values displayed by the Green Field ECO are equal to the values indicated on the EC/pH transmitter screen.

To ensure the measured values are stable it is recommended to immerse the sensor in calibration fluid when doing this process.

Under normal operation conditions the correlation process should be done only when there are system changes, for example when changing EC/pH sensors, nevertheless it is recommended to verify that the readings of the EC/pH transmitter and of the Green Field ECO are equal every time EC/pH calibration is performed and adjust if required.

## 11.6 Sensors Logging

The Sensors Logging screen allows you to define which sensors should be logged.

SENSOR LOGGING	
Data to Collect	Yes/No
Temperature - Average	✓
Temperature sensor - 1	✓
Temperature sensor - 2	✓
Temp sensor - 3	N/A
Temp sensor - 4	N/A
Temp sensor - 5	N/A
Temp sensor - 6	N/A
Temp sensor - 7	N/A
Temp sensor - 8	N/A
Humidity - Average	

Press (+/-) To Select/Deselect

To select an item move the cursor using the arrow keys and mark it using the '+/-' key. Selected items are marked with ✓.

*NOTE* When you change the sensors logging setup, the sensors history table resets and starts over; all sensors' data accumulated on the controller is lost.

*NOTE* The Green Field ECO supports two temperature sensors only.

## 11.7 Write to Data Plug

Use a data-plug to save controller settings and restore them when needed. Plug the Gold Data plug into the data-plug socket (see Figure 3). The data-plug is symmetric so it can be plugged in both directions.

Enter the WRITE TO DATA PLUG screen and confirm your choice.



*NOTE* When writing to a Gold Data-plug, old data on the plug will be overwritten.

## 11.8 Read from Gold Data Plug

Use a data-plug to upload and restore controller settings when needed. Plug the Gold Data Plug into the GREEN FIELD ECO data-plug socket (see the figure below).

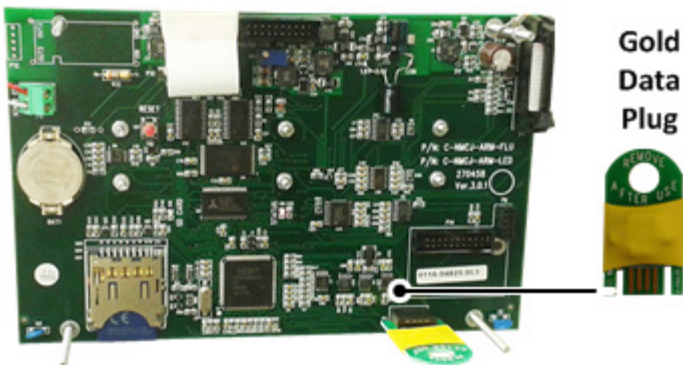
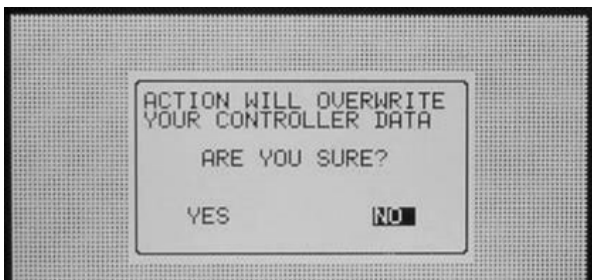

Figure 3: Data Plug

*NOTE Use the Gold Data plug when the system is idle; otherwise, some of the running programs might be interrupted and moved to halt.*

Enter the READ FROM DATA PLUG screen and confirm your choice.



*When reading from the data-plug, the current settings data on the controller will be overwritten.*

# 12 Appendix A: Green Field Eco Parts List

- Green Field ECO Spare Parts List
- Green Field ECO for Korea/China (KC) Spare Parts List

## 12.1 Green Field ECO Spare Parts List

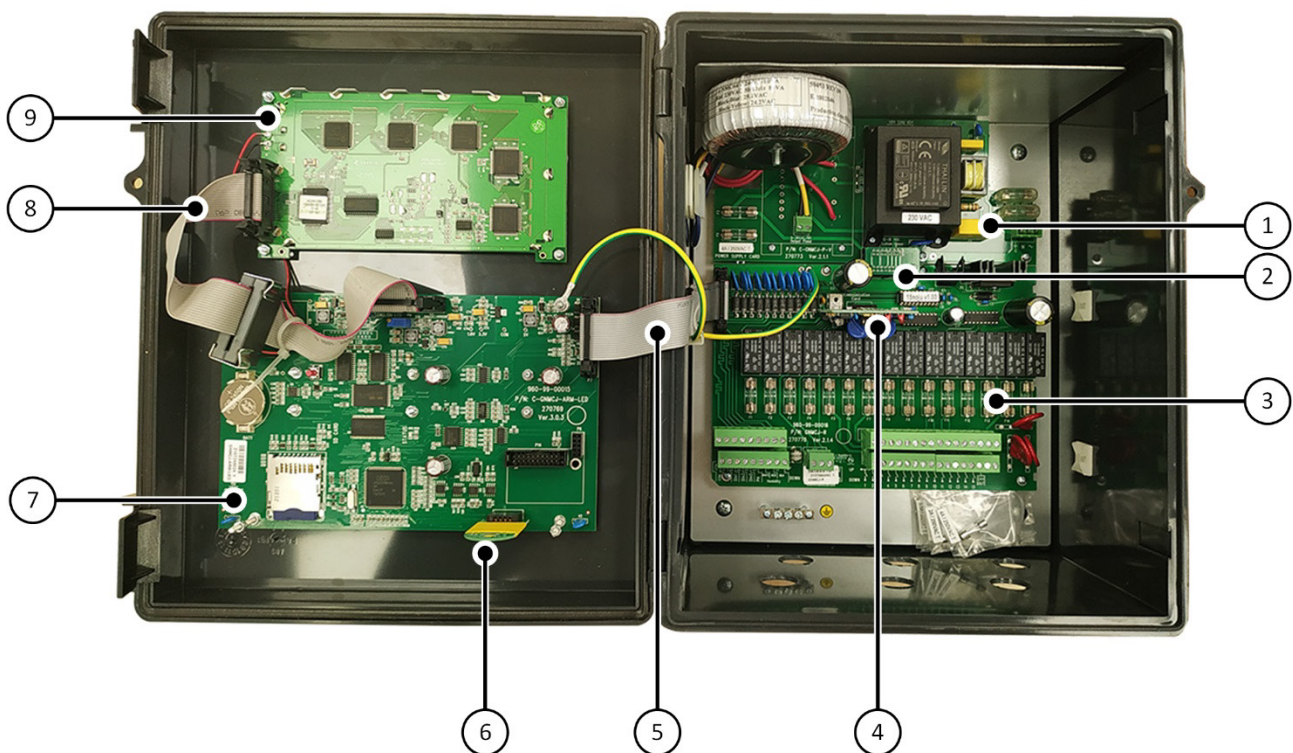

Number	Description	Part Number
1.1	GREEN FIELD ECO Power supply card 115Vac	960-99-00039
1.2	GREEN FIELD ECO Power supply card 230Vac	960-99-00038
2	GREEN FIELD ECO PS TO RELAY JUMPER CARD	960-99-00152
3	GREEN FIELD ECO Relays card	960-99-00016
4	GREEN FIELD ECO Communication card RS-485	960-99-00006
5	GREEN FIELD ECO flat cable for INPUT \ OUTPUT CARD	960-99-00150
6	GREEN FIELD ECO Memory backup key - Data Plug	960-99-00034
7	GREEN FIELD ECO CPU + Keyboard card for Display with LED Backinglight	960-99-00015
8	GREEN FIELD ECO flat cable for Display	960-99-00149
9	GREEN FIELD ECO Display with LED Backinglight	960-99-00036



## 12.2 Green Field ECO for Korea/China (KC) Spare Parts List

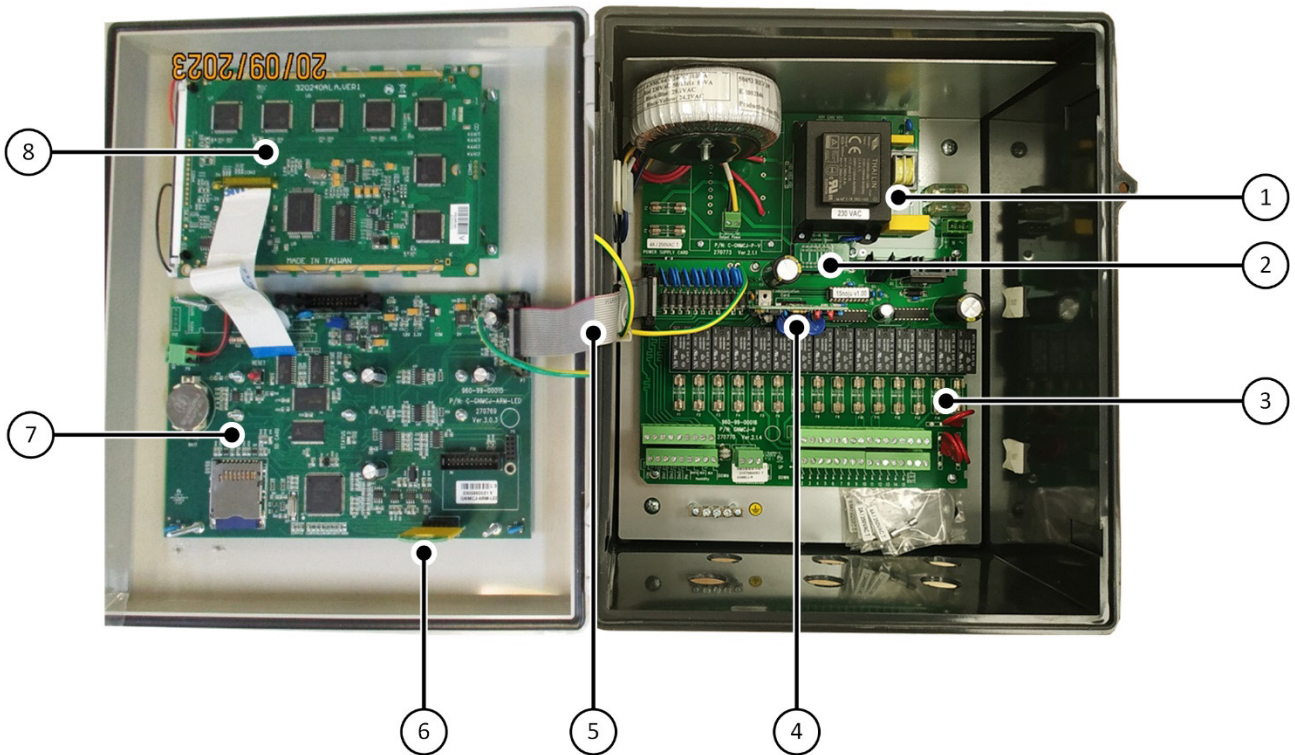

Number	Description	Part Number
1.1	GREEN FIELD ECO Power supply card 115Vac	960-99-00039
1.2	GREEN FIELD ECO Power supply card 230Vac	960-99-00038
2	GREEN FIELD ECO PS TO RELAY JUMPER CARD	960-99-00152
3	GREEN FIELD ECO Relays card	960-99-00016
4	GREEN FIELD ECO Communication card RS-485	960-99-00006
5	GREEN FIELD ECO flat cable for INPUT \ OUTPUT CARD	960-99-00150
6	GREEN FIELD ECO Memory backup key – Data Plug	960-99-00034
7	GREENFIELD ECO ARM CPU FOR GRAPHIC LED DISPLAY (GNMCJ-ARM-LED-GLCD)	960-99-00053
8	GREEN FIELD ECO Display with LED Backlighting for KC	960-99-00151

# 13 Appendix B: Troubleshooting

- Controller Display is Off
- Output Malfunction

## 13.1 Controller Display is Off

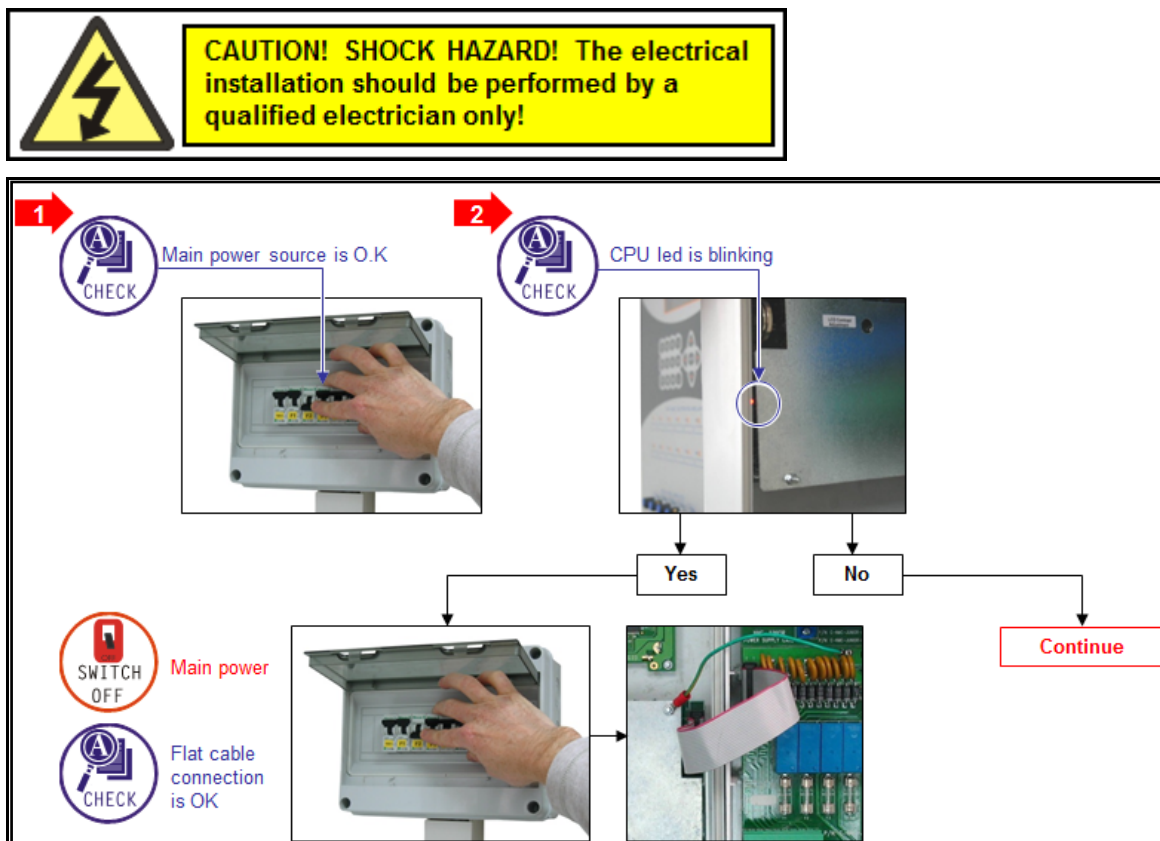



**3**

**PERFORM** Electrical test with Multimeter

**CHECK** ⇒ Phase to ground  
⇒ Phase to neutral

**ENSURE** Phase to ground results:  
Option 1- 230VAC± 10 % (EUR, AFR, AUS)  
Option 2- 115VAC±10% (USA, MEX)

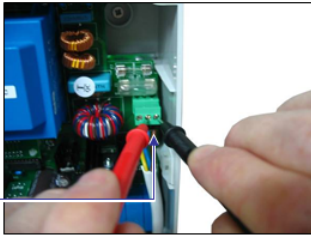
Phase to neutral results:  
Option 1- 230VAC± 10 % (EUR, AFR, AUS)  
Option 2- 115VAC±10% (USA, MEX)





Voltage is OK

No Voltage

Continue to next page

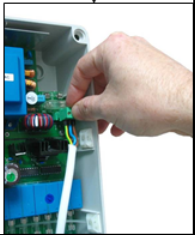
**CHECK** Cable connection is OK



**4**

**SWITCH OFF** Main power



**CHECK** If fuses 1 and 2 are burnt

Burnt

Not burnt

**REMOVE** Fuse from casing

**REPLACE** with extra fuses provided

**NOTE:** Make sure that the same current load is written on the new fuse.

**SWITCH ON** Main power

**ENSURE** 24VAC is available



## 13.2 Output Malfunction

Outputs (valves, pumps etc.) are not working although controller show "ON"

**1**



**SCREW**  
Final high and low terminals of output card



**PERFORM**  
Electrical test with Multimeter of final high and low terminals of output card



**ENSURE**  
Result: 24VAC ± 10%

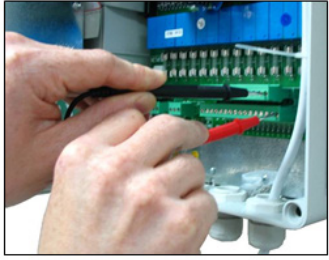
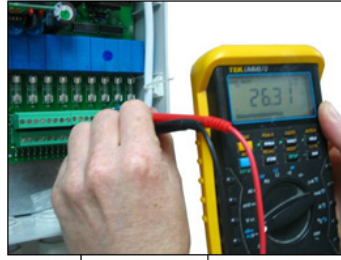



Voltage is OK

No Voltage

Continue







**CHECK**  
Output wire connections and cable

**2**



**SWITCH OFF**  
Main power





**CHECK**  
If fuses 5 and 7 are burnt

Burnt



**REMOVE**  
Fuse from casing



**REPLACE**  
With extra fuses provided

NOTE: Make sure that the same current load is written on the new fuse.

Not burnt

Contact CMT technical support



**SWITCH ON**  
Main power



**ENSURE**  
24VAC is available



# 14 Appendix C: Replacements and Additional Installations

- Power Supply Card
- Relay Card

## 14.1 Power Supply Card

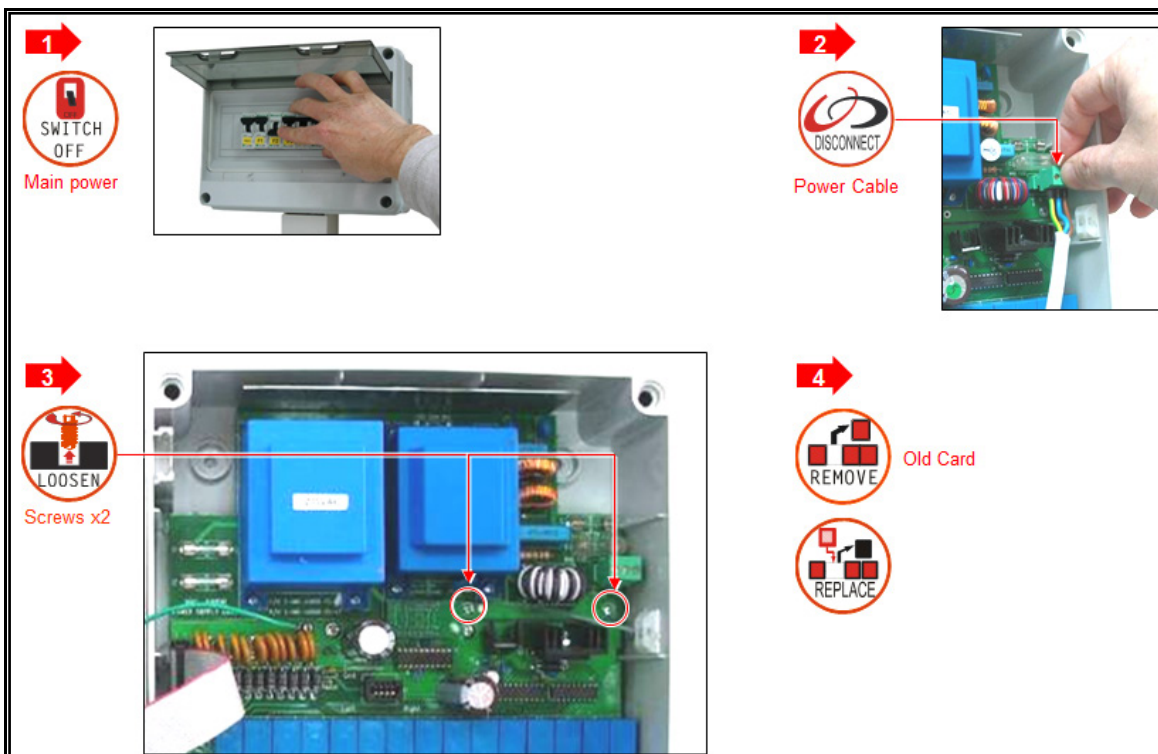

## 14.2 Relay Card

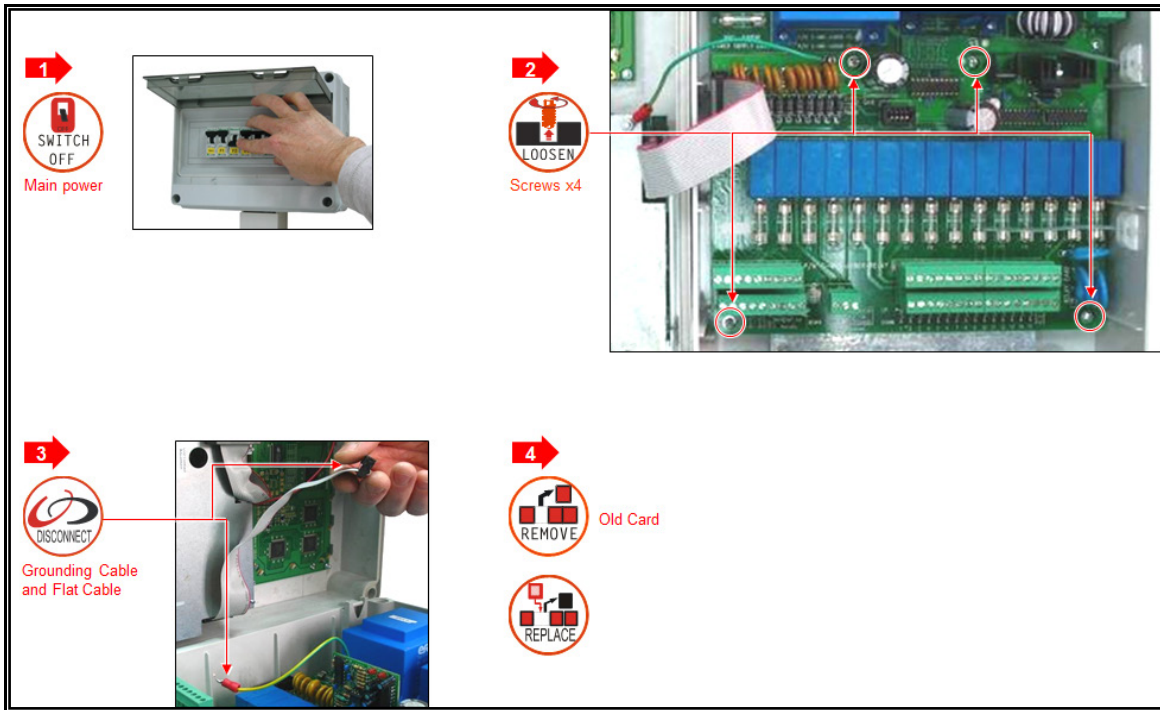

# 15 Appendix D: Sensor Installation and Definition

- EC – pH Sensor Connection, page 95
- Temperature/Humidity Sensor Connection, page 99
- Humidity Sensor Definition, page 99
- Sensor and Cable Specifications, page 100

## 15.1 EC – pH Sensor Connection

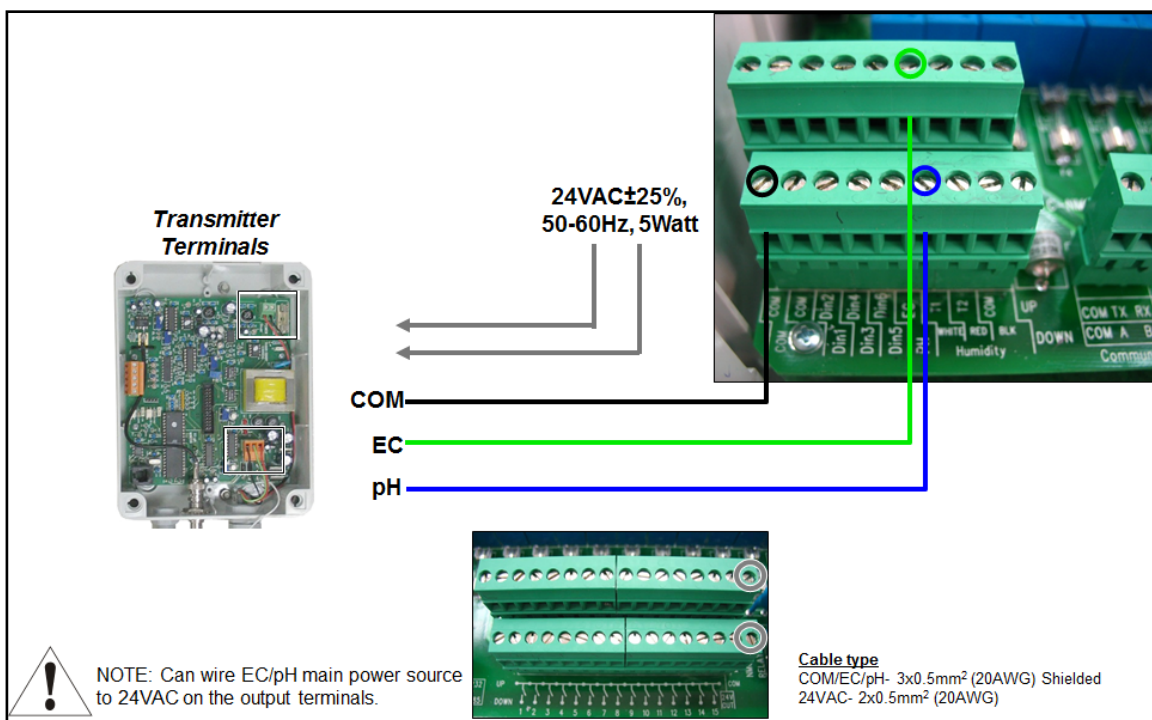

- EC Sensor Calibration, page 95
- pH Sensor Calibration, page 97

### 15.1.1 EC SENSOR CALIBRATION

*NOTE* Perform the following procedure in one continual session. Interruptions or delays while performing the procedure can cause calibration failure.

1. On EC/pH screen press





EC Calibration appears.



2. Press . Calib 1.4 appears.



3. Press .



4. Clean and dry an EC sensor. Insert the sensor into 1.4mS calibration buffer;



immerse for 5 – 7 seconds and immediately press .



Calibration is in process.



*NOTE Perform the following step as soon as the EC 0 screen appears.*

5. When the following screen appears, remove the sensor from the buffer and hold it



in the air; press .

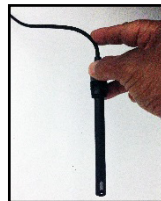

6. Calibration is in process; wait until next screen is displayed, which indicates that EC Calibration is complete.





7. Wait until the following screen appears.

Calibration OK

EC calibration is complete.

### 15.1.2 PH SENSOR CALIBRATION

*NOTE Perform the following procedure in one continual session. Interruptions or delays while performing the procedure can cause calibration failure.*

1. On EC/pH screen, press



EC calibration appears.

EC Calibration

pH Calibration

2. Press



to scroll down to pH CALIBRATION.

3. Press



To pH 7.0 Enter

*NOTE Perform the following step as soon as the EC 7.0 screen appears.*

4. Verify that the pH sensor is dry; insert it into a pH 7 calibration buffer,

immerse for 5 - 7 seconds and press



The following screen appears.

pH: 6.9 Cal: 7.0

5. Calibration is in process, wait until the following screen appears.

To pH 4 - Enter

*NOTE Perform the following step immediately upon appearance of the pH 4 screen.*

6. Verify that the pH sensor is dry; insert it into pH 4 calibration buffer,



immerse for 5 - 7 seconds and press .



The following screen appears.

pH: 3.3 Cal:4.0

7. Wait until the following screen appears.

Calibration OK

pH calibration is complete.

## 15.2 Temperature/Humidity Sensor Connection

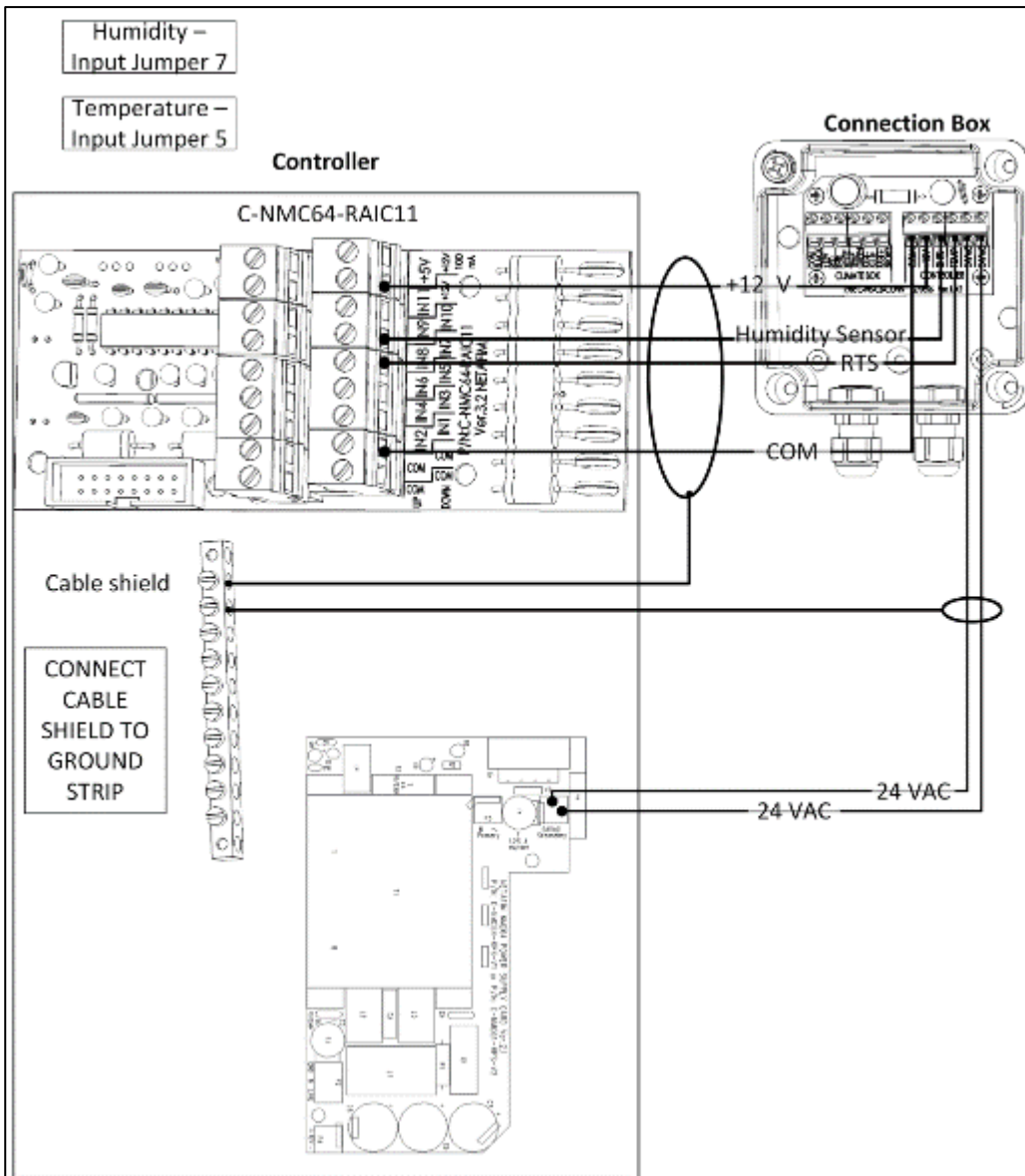

NOTE Can wire 24VAC terminals of measuring box to 24VAC on the output terminals

### 15.2.1 HUMIDITY SENSOR DEFINITION

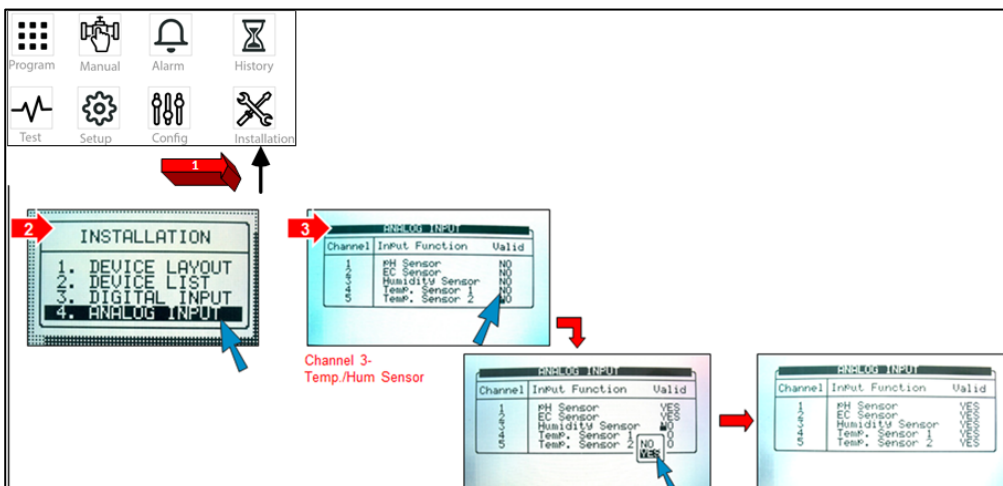

### 15.3 Sensor and Cable Specifications

Sensor Type	Measured Values	Accuracy	Input Range	Maximum Cable Length	Cable Type
Temperature – RTS-s	-20° to 50° C/ -4° to 122°F	0.3°C/0.54°F	30kOhm	500 meter (1640 feet)	2x0.5 mm <sup>2</sup> (20 AWG)
EC	0 to 10 mS (old transmitters used 20 mS)	0.05 to 0.1 mS	4 – 20mA	---	3x0.5 mm <sup>2</sup> (20 AWG) Shielded
pH	0 - 14	0.1	4 – 20mA	---	
RH – RHS-10	0 – 100%	±2% (10% - 90% RH), ±3.5% (90% - 100% RH)	0 – 3 VDC	300 meter (985 feet)	3x0.5 mm <sup>2</sup> (20 AWG)

# 16 Appendix E: Technical Specifications

- Technical Specifications
- Controller Components

## 16.1 Technical Specifications

		Small Plastic box (Indoor installation)	Sealed Plastic box (Outdoor installation)
Housing	Plastic housing with a screw on lid	IP 65	IP 65
	Dimensions (L x W x H)	22.5x31x13 cm (8.86x12.2x5.12 inch)	32.5x29.0x18.0 cm (12.79x11.41x7.08 inch)
	Weight	4.5 kg 9.9 lbs.	5.5Kg 12.12 lbs.
Ambient Conditions	Operating temperature range	-10 to +60° Celsius (14 to 140° Fahrenheit)	-10 to +60° Celsius (14 to 140° Fahrenheit)
	Storage temperature range	-10 to +70° Celsius (14 to 158° Fahrenheit)	-10 to +70° Celsius (14 to 158° Fahrenheit)
Approvals	The 115/230VAC has Safety CE approval	EN61010-1	EN61010-1
	EMC approval CE	EN55011 Class A EN55011 Class B EN61000-4-2,3,4,5,6,8,11	EN55011 Class A EN55011 Class B EN61000-4-2,3,4,5,6,8,11

## 16.2 Controller Components

- Keyboard & Display, page 102
- Hardware Components, page 103
- Power Supply Card, page 106

### 16.2.1 KEYBOARD & DISPLAY

- Graphical LCD Display
- Back light
- 5.5"

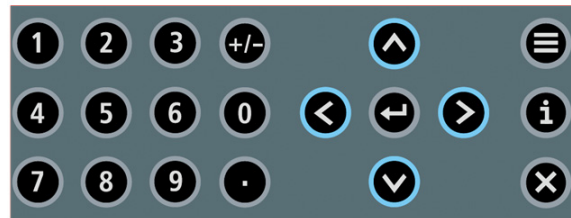
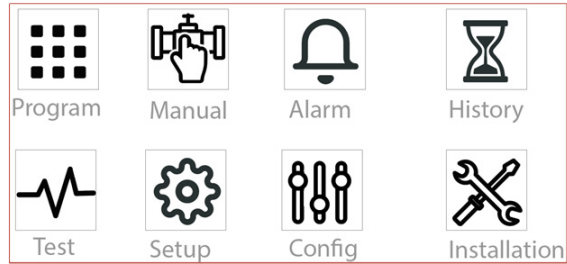

- Tactile feel Keyboard

## 16.2.2 HARDWARE COMPONENTS

- Components
- Hardware Layout

### 16.2.2.1 Components

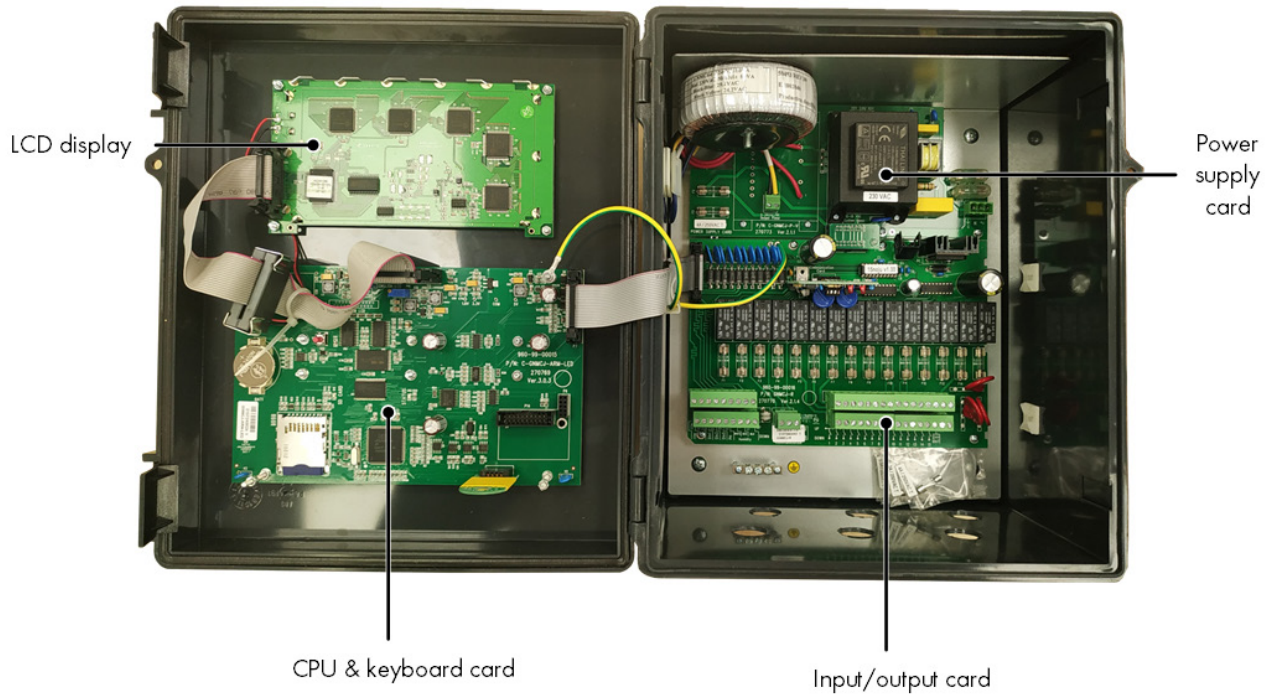

### 16.2.2.2 Hardware Layout

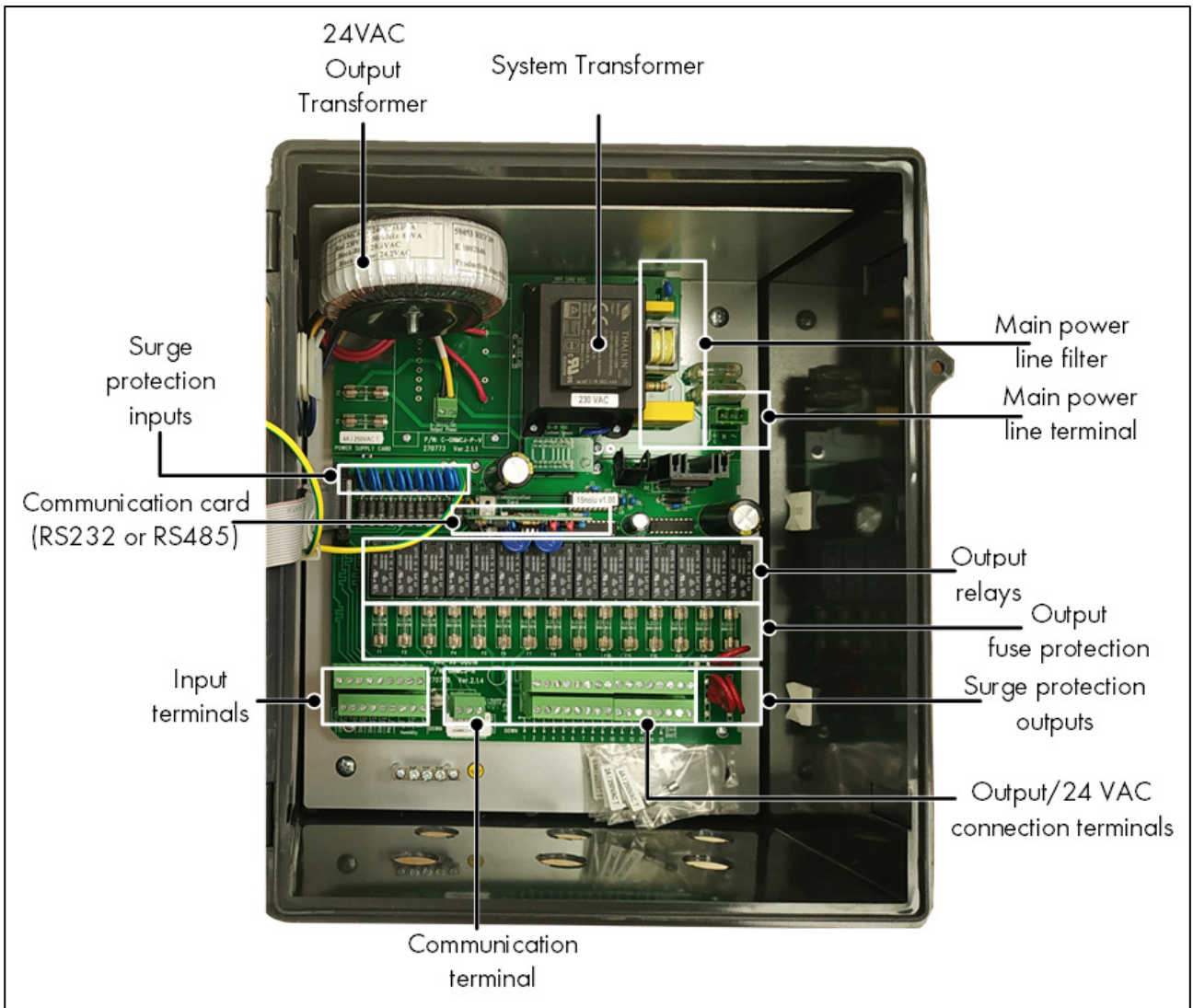



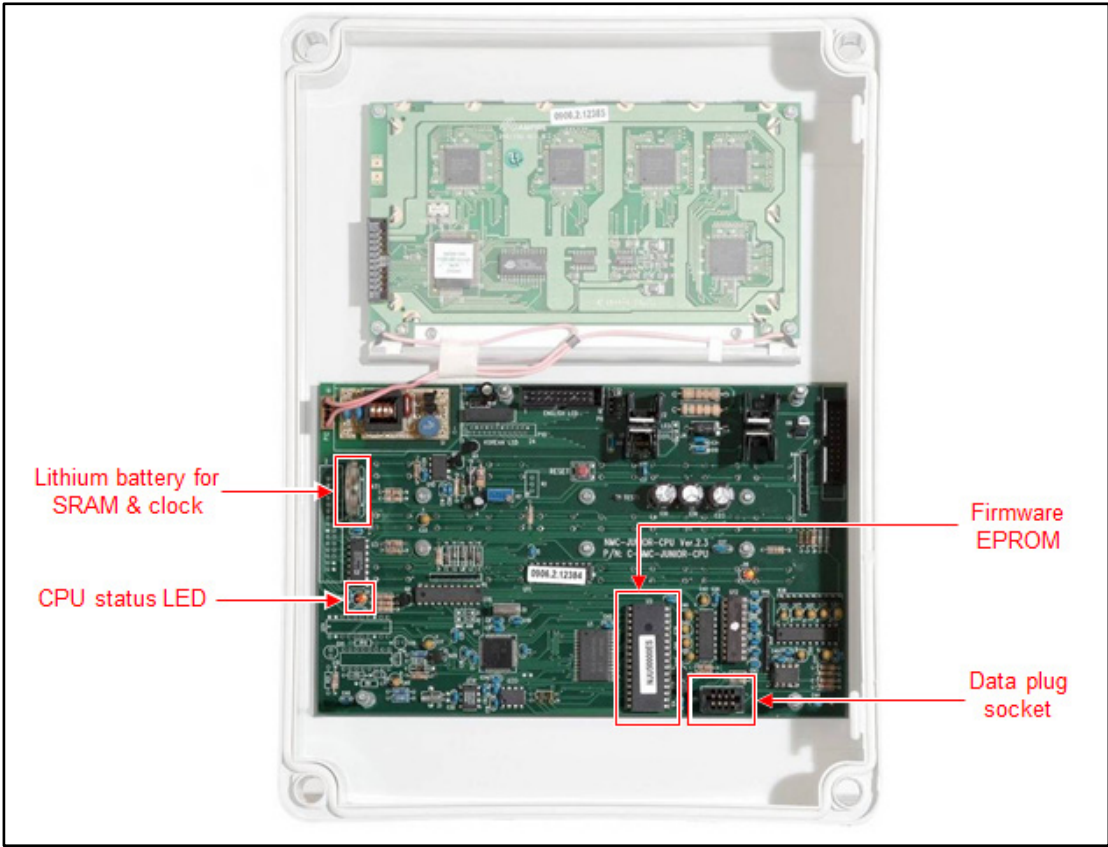

Lithium battery for  
SRAM & clock

CPU status LED

Firmware  
EPROM

Data plug  
socket

### 16.2.3 POWER SUPPLY CARD

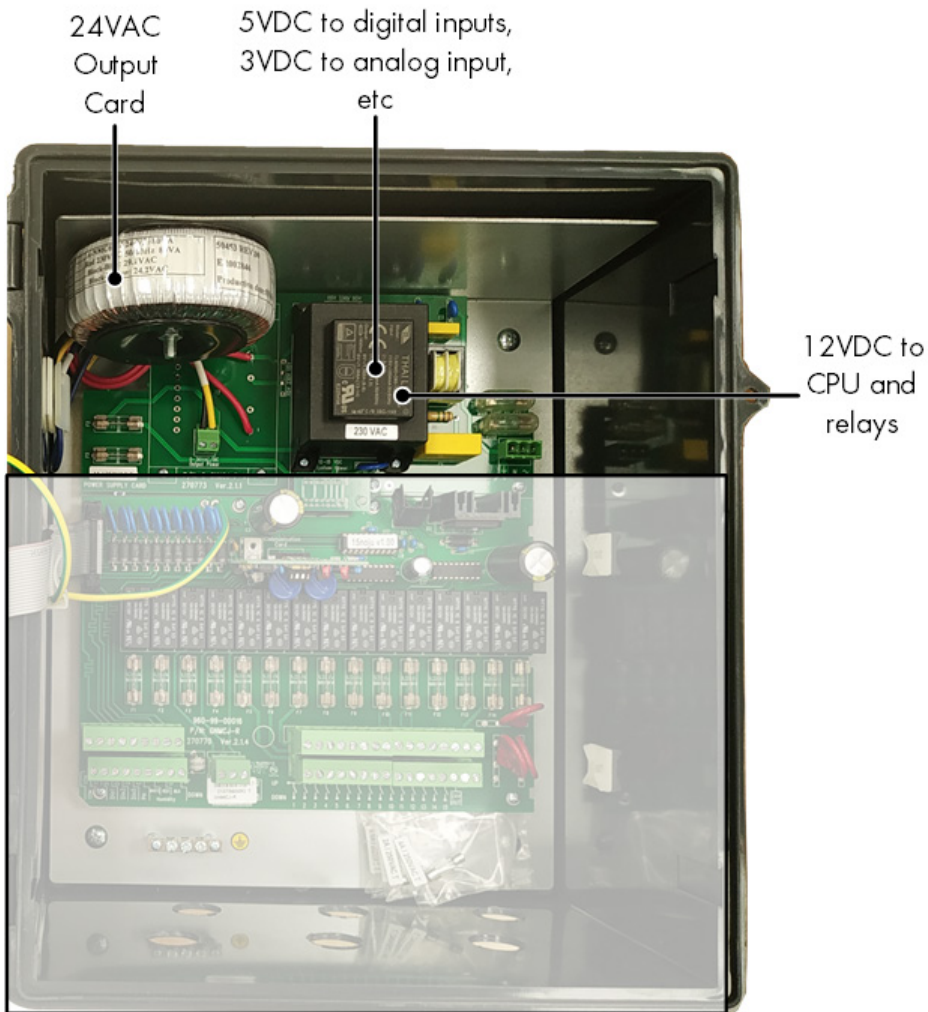

- Option A: 115 or 230 VAC Power Supply Card
- Option B: 115VAC or 230VAC Power Supply Card with External 24VAC Power for Output Devices
- Option C: 12VDC Power Supply Card

### 16.2.3.1 Option A: 115 or 230 VAC Power Supply Card

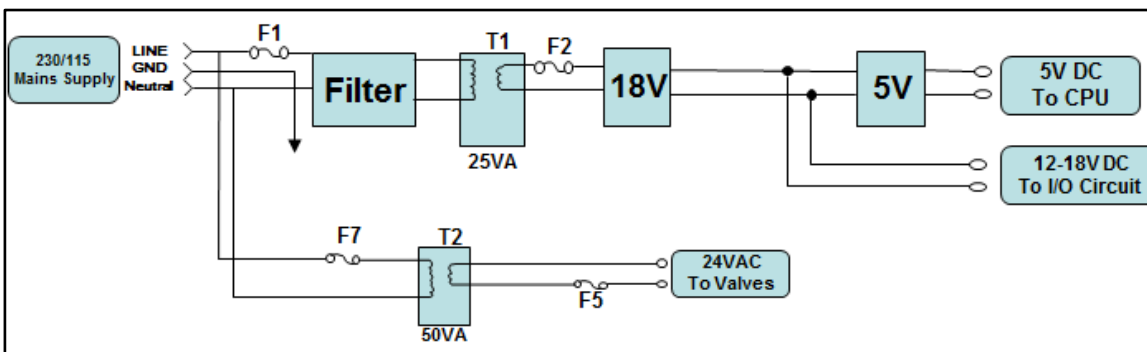
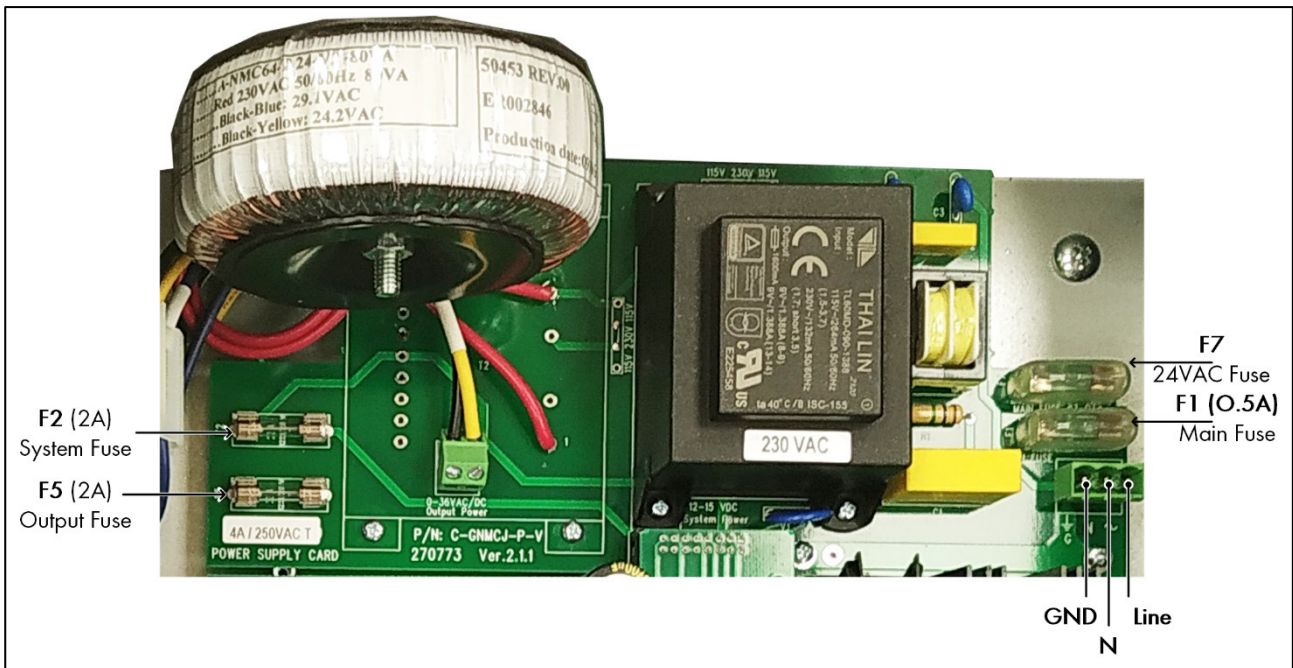

Specifications				
Main voltage	Main frequency	Max voltage	Min voltage	Main fuse
Single phase 230 VAC, 0.5 Amp	50/60 H	250 VAC	200 VAC	0.5 Amp
Single phase 110 VAC, 0.5 Amp	50/60 H	130 VAC	90 VAC	0.5 Amp

**NOTE** Green Field ECO units support 115 VAC, 230 VAC, or both. Each unit has a silver label stating the unit's voltage. Verify that the power supply matches the unit's requirements.

**NOTE** 24 VAC available power for peripheral equipment: 50Watt/2A.

### 16.2.3.2 Option B: 115VAC or 230VAC Power Supply Card with External 24VAC Power for Output Devices

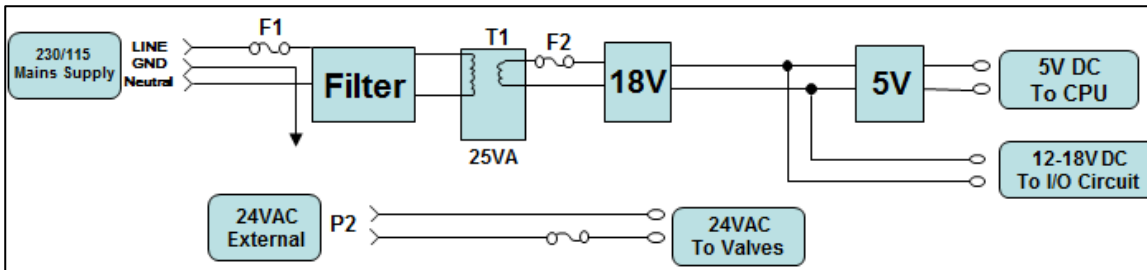
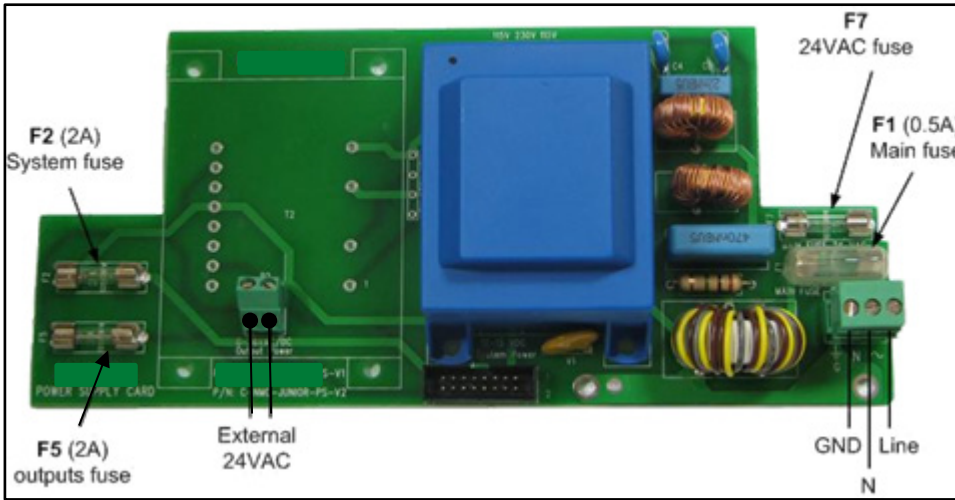

Specifications				
Main voltage	Main frequency	Max voltage	Min voltage	Main fuse
Single phase 230 VAC, 0.5 Amp	50/60	250 VAC	200 VAC	0.5 Amp
Single phase 110 VAC, 0.5 Amp	50/60	130 VAC	90 VAC	0.5 Amp

**NOTE** System uses 24VAC External transformer with limit of 6.3 Amp (F5).

### 16.2.3.3 Option C: 12VDC Power Supply Card

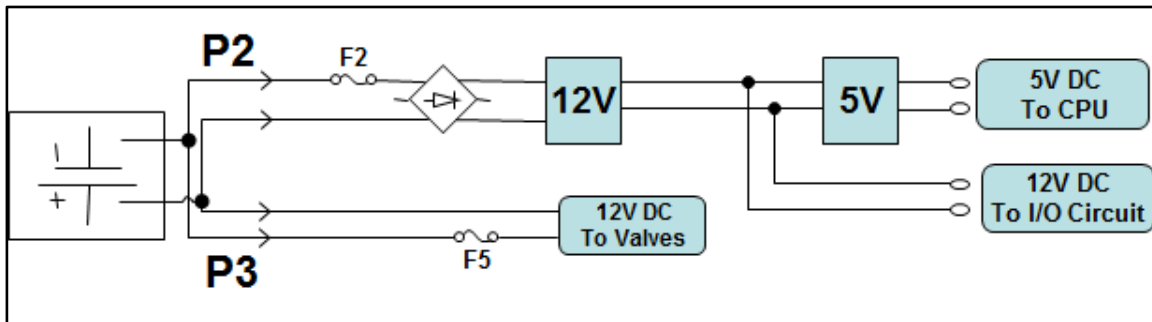
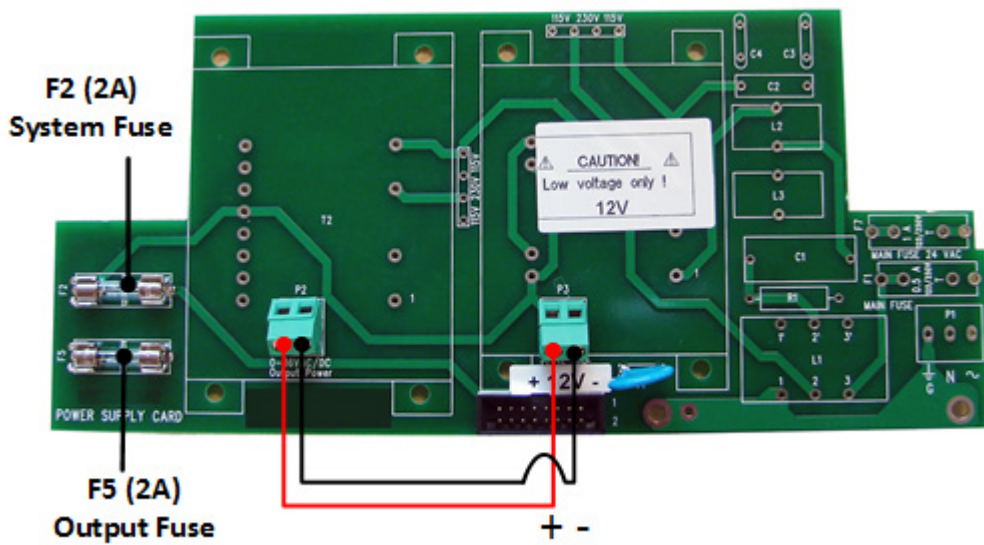

#### Specifications

Main voltage	System fuse
12 – 48 VDC/VAC	2 Amp

## 16.2.4 INPUT AND OUTPUT CARD



The Input & Output cards consist of:

Analog inputs	1x EC input	4 - 20 mA
	1x pH input	4 - 20 mA
	1x humidity sensor input	0 - 3 VDC
	2x temperature sensor input	30K $\Omega$ THERMISTOR
Digital inputs	6x digital input	5V/2mA, max pulse rate 50 Pulse/Sec
Relays outputs	15x N.O output	24VAC low power relay, 5 Amps, maximum output changing rate 0.4 Sec
Communication	1x RS232/RS485 port	RS232 or RS485 communication port, function depends on type of connection and type of MUX used.

# 17 Appendix F: Main Menu Tree

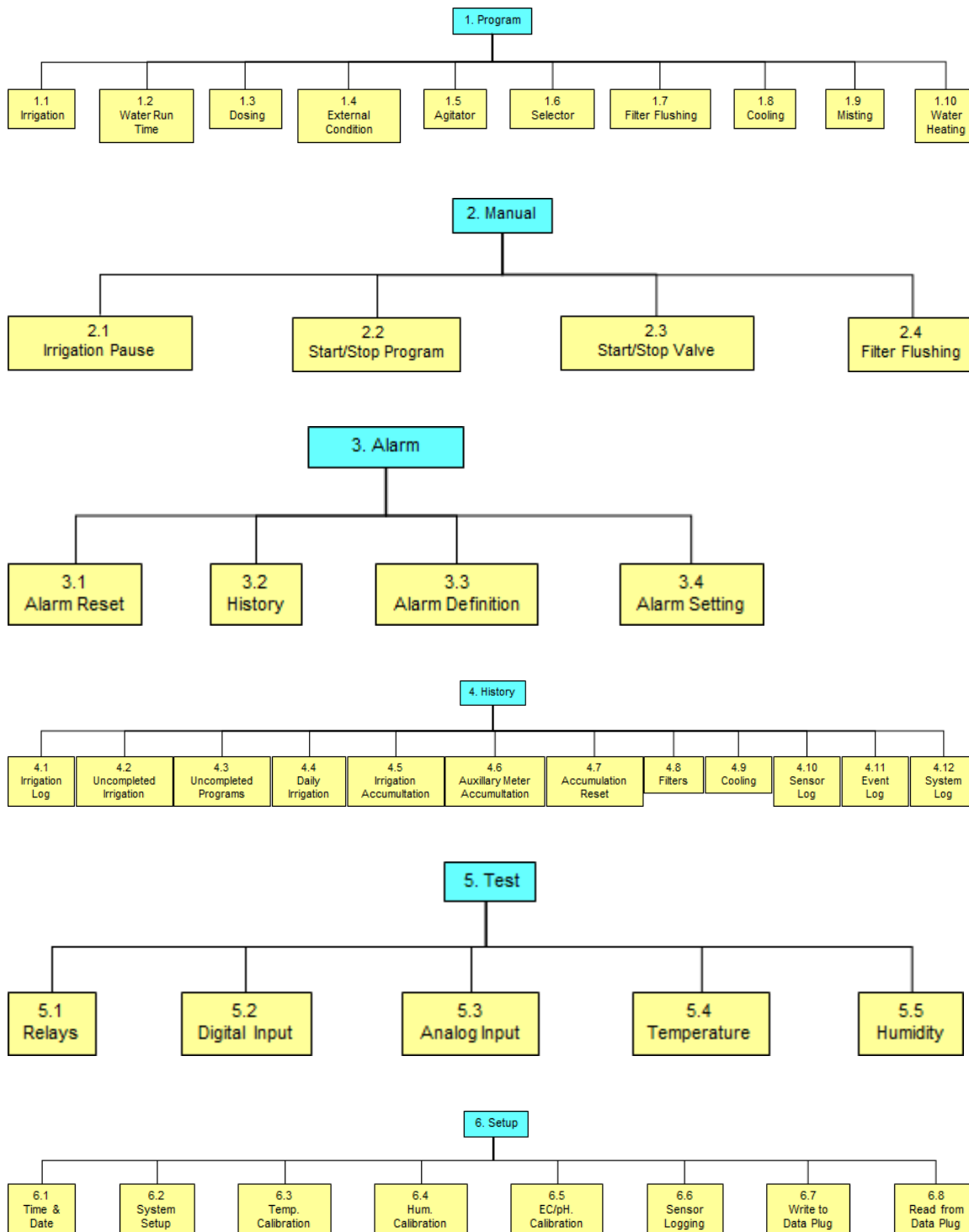

# 18 Warranty

## Warranty and technical assistance

Munters products are designed and built to provide reliable and satisfactory performance but cannot be guaranteed free of faults; although they are reliable products they can develop unforeseeable defects and the user must take this into account and arrange adequate emergency or alarm systems if failure to operate could cause damage to the articles for which the Munters plant was required: if this is not done, the user is fully responsible for the damage which they could suffer.

Munters extends this limited warranty to the first purchaser and guarantees its products to be free from defects originating in manufacture or materials for one year from the date of delivery, provided that suitable transport, storage, installation and maintenance terms are complied with. The warranty does not apply if the products have been repaired without express authorisation from Munters, or repaired in such a way that, in Munters' judgement, their performance and reliability have been impaired, or incorrectly installed, or subjected to improper use. The user accepts total responsibility for incorrect use of the products.

The warranty on products from outside suppliers fitted to Green Field ECO, (for example antennas, power supplies, cables, etc.) is limited to the conditions stated by the supplier: all claims must be made in writing within eight days of the discovery of the defect and within 12 months of the delivery of the defective product. Munters has thirty days from the date of receipt in which to take action, and has the right to examine the product at the customer's premises or at its own plant (carriage cost to be borne by the customer).

Munters at its sole discretion has the option of replacing or repairing, free of charge, products which it considers defective, and will arrange for their despatch back to the customer carriage paid. In the case of faulty parts of small commercial value which are widely available (such as bolts, etc.) for urgent despatch, where the cost of carriage would exceed the value of the parts, Munters may authorise the customer exclusively to purchase the replacement parts locally; Munters will reimburse the value of the product at its cost price.

Munters will not be liable for costs incurred in demounting the defective part, or the time required to travel to site and the associated travel costs. No agent, employee or dealer is authorised to give any further guarantees or to accept any other liability on Munters' behalf in connection with other Munters products, except in writing with the signature of one of the Company's Managers.

**WARNING:** In the interests of improving the quality of its products and services, Munters reserves the right at any time and without prior notice to alter the specifications in this manual.



The liability of the manufacturer Munters ceases in the event of:

- dismantling the safety devices;
- use of unauthorised materials;
- inadequate maintenance;
- use of non-original spare parts and accessories.

Barring specific contractual terms, the following are directly at the user's expense:

- preparing installation sites;
- providing an electricity supply (including the protective equipotential bonding (PE) conductor, in accordance with CEI EN 60204-1, paragraph 8.2), for correctly connecting the equipment to the mains electricity supply;
- providing ancillary services appropriate to the requirements of the plant on the basis of the information supplied with regard to installation;
- tools and consumables required for fitting and installation;
- lubricants necessary for commissioning and maintenance.

It is mandatory to purchase and use only original spare parts or those recommended by the manufacturer.

Dismantling and assembly must be performed by qualified technicians and according to the manufacturer's instructions.

The use of non-original spare parts or incorrect assembly exonerates the manufacturer from all liability.

Requests for technical assistance and spare parts can be made directly to the nearest [Munters office](#).

