



KP-8IN-1REL, TP-8IN-1REL, TR-2IN-1REL

Models:
890-00607

Installation manual

895-00695
Version 01

Date: 08-22-16

AgriAlert



895-00695

Contents

Chapter 1	Introduction.....	5
	Contact information	5
	General safety precautions and usage	5
	Terms of use	7
	What to look for when you receive your system.....	8
	System overview	9
	Operating environment	12
	Clearance around the KP-8IN-1REL, TP-8IN-1REL, TR-2IN-1REL	13
	Correctly supporting and routing cables	13
	Grounding recommendations for the system	14
Chapter 2	Basic connections.....	17
	Preparing the enclosures for installation.....	17
	Mounting the enclosures	17
	DC network or independent power supply connection	18
	Connecting the the KP-8IN-1REL, TP-8IN-1REL, TR-2IN-1REL to the communication network	19
	Connecting an analog input.....	20
	Connecting the relay output	21
	Grounding	22
Chapter 3	Maintenance.....	23
	Inspecting and cleaning the enclosure	23
	Inspecting and tightening connections	23
Chapter 4	Troubleshooting.....	25
Appendix A	Navigating through the KP-8IN-1REL	27
Appendix B	LED meaning.....	29
Appendix C	List of terminals	31
Appendix D	Technical Specifications	33
Appendix E	Safety Characteristics and Certification.....	37
Appendix F	EC Declaration of Conformity (In accordance with EN ISO 17050-1 2004).....	41
Appendix G	FCC part 15 statement.....	45
Appendix H	FCC RF exposure statement.....	47
Appendix I	Innovation, Science and Economic Development Canada ICES-003 Compliance CAN ICES-3 (A)/NMB-3(A).....	49
Appendix J	FDA declaration.....	51
Appendix K	Reduction of Hazardous Substances	53
Appendix L	Disposal and Recycling Information.....	55
Appendix M	Product material composition	57
Appendix N	Packaging characteristics	59
Appendix O	Low voltage cable specifications	61
Appendix P	Extending a cable.....	63
Appendix Q	KP-8IN-1REL, TP-8IN-1REL, TR-2IN-1REL - Product End-of-Life Disassembly Instructions	65
	GSI Group, LLC Limited Warranty	69

NOTES

1 Introduction

Topics Covered in this Chapter

- Contact information
- General safety precautions and usage
- Terms of use
- What to look for when you receive your system
- System overview
- Operating environment
- Clearance around the KP-8IN-1REL, TP-8IN-1REL, TR-2IN-1REL
- Correctly supporting and routing cables
- Grounding recommendations for the system

Contact information

Manufacturer

GSI Electronics

5200 Armand Frappier

Saint-Hubert, Qc

Canada

J3Z 1G5







Warranty is void if this product is used in a manner not specified by the manufacturer. Every effort has been made to ensure that this manual is complete, accurate and up to date. The information contained in this manual is subject to change without notice.

General safety precautions and usage

Safety symbols

	Warning. Read the following text carefully; it contains important information which, if ignored, may cause the controller to operate improperly
	High Voltage. Hazard of electrical shock. Read the message and follow the instructions carefully
	Direct current (DC)
	Alternating current (AC)

	<p>Protective Earth Ground Terminal, Primarily used for protective earth terminals.</p> <p>Terminal connected to conductive parts of a device for the purpose of safety and is intended to be connected to an external system for protective grounding</p>
	<p>Functional Ground Terminal Primarily used for functional earth terminals which are generally associated with test and measurement circuits. These terminals are not for safety earthing purposes but provide an earth reference point.</p>
<p>NOTE:</p>	<p>To emphasize points or remind readers of something, or to indicate minor problems in the outcome of what they are doing</p>
	<p>Failure to follow the instructions can result in damaged equipment or loss of data or potential problems</p>
	<p>Failure to follow the instructions carefully can result in serious or fatal injury</p>
<p>IMPORTANT:</p>	<p>The following information is of great significance and must be read carefully</p>
	<p>Read the following text carefully; it contains important information which, if ignored, may cause the controller to operate improperly</p>
<p>Tip</p>	<p>Shortcut or a faster way of getting to an end result</p>

Safety messages



Turn off the main electrical disconnect switch prior to servicing any of the boxes. Failure to do so might lead to serious injury or death.

Always use extreme caution when measuring voltage or performing procedures that require a module to be powered on.

Electrostatic discharge prevention when manipulating a printed circuit board (PCB)

Electrostatic discharge (ESD) can damage equipment and impair electrical circuitry. ESD damage occurs when electronic components are improperly handled and can result in complete or intermittent failures.

Always follow ESD on a PCB-prevention procedures when you remove and replace components. Ensure that the chassis is electrically connected to earth ground. Wear an ESD-preventive wrist strap, ensuring that it makes good skin contact. Connect the grounding clip to an unpainted surface of the chassis frame to safely ground unwanted ESD voltages. To guard against ESD damage and shocks, the wrist strap and cord must operate properly. If no wrist strap is available, ground yourself by touching the metal part of the chassis.

For safety, periodically check the resistance value of the antistatic strap, which should be between 1 and 10 megohm (Mohm).

Telecommunication advice

FCC Caution and Safety Notices:

Any changes or modifications (including the antennas) made to this device that are not expressly approved by the manufacturer may void the user's authority to operate the equipment. This device and its antenna(s) must not be co-located or operating in conjunction with any other antenna or transmitter.

FCC ID and IC ID

Health and radiation

This equipment should be installed and operated with minimum distance 20 cm between the radiator and your body. Equipment type and class type of the RFID module according to (ETSI EN 301 489-3)

Equipment type (ETSI EN 301 489-3)	III	Others : Identification/Access control
Class type (ETSI EN 301 489-3)	2	(Medium reliable SRD communication media; e.g. causing inconvenience to persons, which cannot simply be overcome by other means)

Terms of use

Read and follow all installation, operation, and maintenance information carefully before using the product. Refer to the user documentation for complete product specifications. If the product is used in a manner not specified, the protection provided by the product warranty will be void.

Using the product according to your function

A responsible body is an individual or group responsible for the use and maintenance of equipment, for ensuring that the equipment is operated within its specifications and operating limits, and for ensuring that operators are adequately trained.

Operators use the product for its intended function.

Maintenance personnel perform routine procedures on the product to keep it operating properly

Service personnel are trained to work on live circuits, perform safe installations, and repair products. Only properly trained service personnel may perform installation and service procedures.

General safety usage

Follow the guidelines given below for safe usage of the product:

- Installation must only be performed by qualified service personnel
- Carefully read all instructions
- Comply with local and national safety codes
- Repairs must only be performed by qualified service personnel
- When replacing the fuses, use only the same type and same rating as specified

Chapter 1: Introduction

- Make sure the unit is disconnected from AC Power when servicing
- Do not try to operate the system if it is damaged. Disconnect the Power from the units and call your local service representative
- Do not operate while condensation is present
- Use of the system in a manner not specified by these instructions may impair the safety protection provided by the system. Do not operate the system outside its rated supply voltages or environmental range
- Omission to read the installation and user manuals or to comply with the warnings and references contained herein can result in serious bodily injury or damages to the controllers
- Do not insert metal objects into the connectors
- Use the system only as specified, or the protection supplied by the product can be compromised
- Follow all installation and maintenance recommendations and consider all provided information regarding product specifications and limitations
- Do not use the system if it does not operate correctly
- The enclosures must be closed and locked at all times, particularly when operating the system
- Use only specified replacement parts

What to look for when you receive your system

Table 1-1 *Shipment contents*

KP-8IN-1REL	1 X KP-8IN-1REL 1 X Quick guide
TP-8IN-1REL	1 X TP-8IN-1REL 1 X Quick guide
TR-2IN-1REL	1 X TR-2IN-1REL 1 X Quick guide

Damage inspection

Your system and its components were carefully inspected both electrically and mechanically before shipment. After unpacking all items, check for any obvious signs of physical damage that may have occurred during transit. Report any damage to the shipping agent immediately. Save the original box for possible future shipment.

Returning the unit for repair

If you must return the system for repair, carefully package the system in its original box or an equivalent, and follow these instructions:

1. Call the customer service department to get a Return Material Authorization (RMA) number. Have on hand the system's serial number and date code found on the system's main board.
2. Indicate clearly that the box is to be given to the repair department and attach a copy of the RMA number on the shipping label.

Contact information

If you experience trouble with your system, or to get repair or warranty information, please contact GSI Electronics Inc.

Phone: 1-877-926-2777

E-mail: mtl_techsupport@gsiag.com.

System overview

These external modules can be used with the Agri Alert 128 Touch system network.

KP-8IN-1REL — Remote keypad displaying data from the main system that allows the addition of 8 sensors inputs and a programmable relay output

Figure 1-1 KP-8IN-1REL



TP-8IN-1REL — Remote expansion module that allows the addition of 8 sensors inputs and a programmable relay output

Figure 1-2 TP-8IN-1REL



TR-2IN-1REL — Remote expansion module that allows the addition of 2 sensors inputs and a programmable relay output

Figure 1-3 TR-2IN-1REL

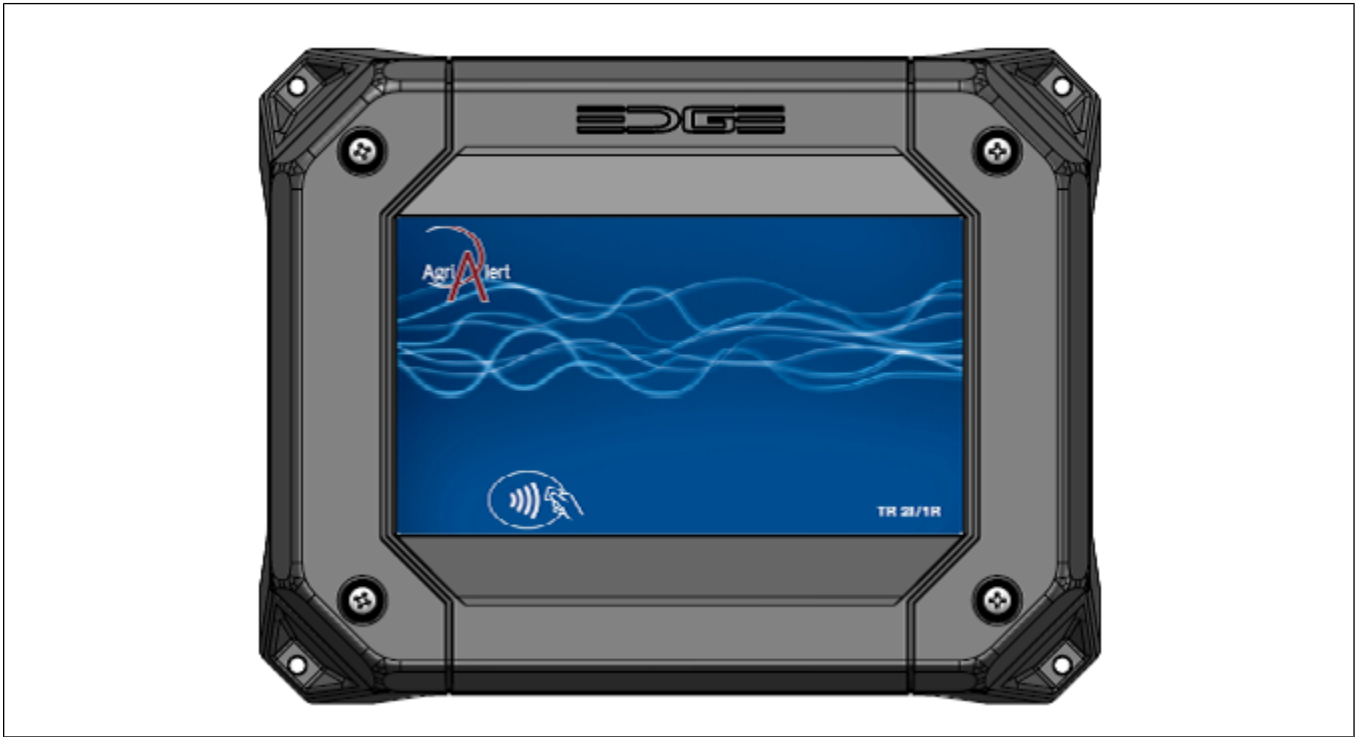













The KP-8IN-1REL and TR-2IN-1REL modules are equipped with an RFID tag reader. This means that every time a tag is scanned, it keeps track of the scan and sends information to the Main Controller. In addition, when you activate the output through a scan, the relay is energized for the predetermined period of time. Even if the module is disconnected from the Main Controller, it will be able to scan, record and activate the output. To ensure compatibility with system, use the tags provided with the module.

The hardware features according to the model are as follows:

Product Name	Features					
	RS-485 port	Configurable input	Relay output with current reading (5A)	OLED display	RFID Reader	Keypad
KP-8IN-1REL	2	8	1	1	1	1
TP-8IN-1REL	2	8	1	1		
TR-2IN-1REL	2	2	1		1	

KP-8IN-1REL menus and navigation

			F1
			F2
			F3
			F4

Key description

- 1 - Zone: click to access a specific zone
- 2 - Arm : arm / disarm the system
- 3 - History : access history
- 4 - Output : access output menu
- 5 - Up : navigation menu up
- 6 - Module : access module menu
- 7 - Left : navigation menu left
- 8 - Down : navigation menu down
- 9 - Right : navigation menu right
- 0 - Settings : access settings
- Red Circle : Cancel
- Checkmark : Enter
- F1 – F4 : in menu options

For complete navigation instructions, see [Appendix A Navigating through the KP-8IN-1REL, page 27](#)

Operating environment

Inside use

To avoid exposing the system to harmful gases or excessive humidity, install the KP-8IN-1REL, TP-8IN-1REL, TR-2IN-1REL in a corridor or a room dedicated to electronic controllers. The ideal ambient temperature is between 20 °C and 25 °C (68 °F - 77 °F). The temperature should not be below 0 °C (32 °F) and should not exceed 40 °C (104 °F).

Ensure there is sufficient ventilation around the unit.

Install the KP-8IN-1REL, TP-8IN-1REL, TR-2IN-1REL far from sources of vibrations and where they are not likely to get bumped.

Outside use

Install the KP-8IN-1REL, TP-8IN-1REL, TR-2IN-1REL far from sources of vibrations and where they are not likely to get bumped.

Install the KP-8IN-1REL, TP-8IN-1REL, TR-2IN-1REL in an easily accessible area.

IMPORTANT: *If you are not planning on installing the system immediately, store it in a cool dry place.*

Requirements for the mounting structure

Fix the enclosure into the supporting structure behind the drywall. If this is not possible, consider the addition of a wood frame on which the enclosure could be screwed.

Clearance around the KP-8IN-1REL, TP-8IN-1REL, TR-2IN-1REL

Figure 1-4 Minimum clearance

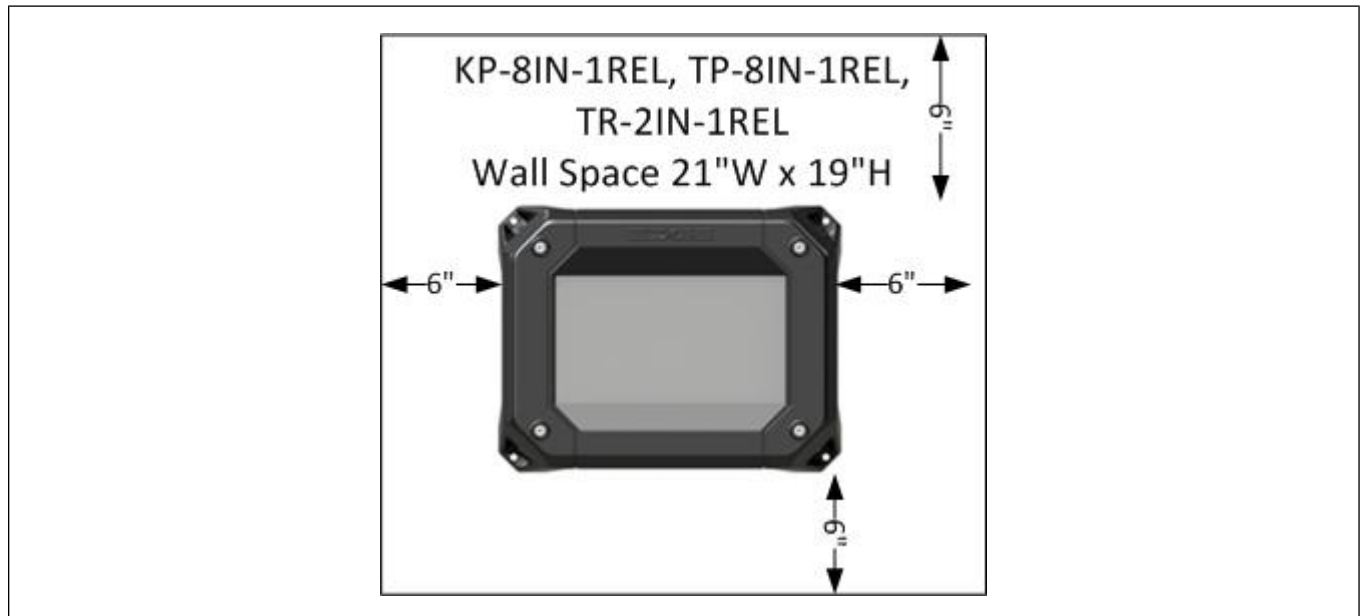

Correctly supporting and routing cables

Properly supporting and routing the cables helps avoid electromagnetic interference and wire damage. Rigid conduits of up to 1 inch (25.4mm) can be used for connection to the P-8IN-1REL, TP-8IN-1REL, TR-2IN-1REL.

NOTE: Nylon cable glands are permitted for cable or wire fastening.



Use watertight compression cable glands rated IP66 for each cable used.



Use silicone to seal the cable gland rated IP66 if more than one cable is used in the same cable gland.



The warranty is void if the product enclosures are not sealed correctly and the installation does not respect the manufacturer recommendations.



Ensure all cables enter through the bottom of the plastic enclosure. Do not make holes on the top or on the sides of the enclosures. Be careful not to damage the electronic cards located inside the enclosure when drilling at the bottom of the enclosure.

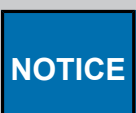

The use of flexible tube with water and dust tight connectors at both ends is acceptable.

Cable support

Support the cables with clips or cable trays whenever possible to avoid damage at the connection points.

Cable routing

NOTICE

Never run low voltage (24V and less) wires like communication wires, inputs or sensor wires in the same conduit as a high voltage (Power) wires.

When low voltage cables run parallel to high voltage cables (120/230/380 VAC or 24 VDC), place them at a distance of at least 300 mm (12 inches) from each other to avoid electromagnetic interference.

If low voltage cables cross high voltage cables, ensure they cross at a 90° angle to minimize electromagnetic interference.



Do not use rigid conduits over 1 inch (25.4mm) for the KP-8IN-1REL, TP-8IN-1REL, TR-2IN-1REL.

Grounding recommendations for the system

A correctly grounded system protects your equipment from electrical surges and spikes.



Each module must have its own ground connection from a common junction box. Do not run the earth ground cable between the modules.

NOTICE

The ground resistance levels must comply with local and national electrical codes.

IMPORTANT: *If outdoor connections are used, mount the enclosure as close as possible to the entry point of the outdoor wiring.*

IMPORTANT: *An improper ground connection voids the system's warranty.*

Insert the rod into the ground until a few inches of the tip is left above ground level. Attach the cable to the rod tip with an appropriate connector. Attach the other end of the cable to a breaker box or a junction box near the main enclosure.

Figure 1-5 Grounding installation depending on bedrock depth

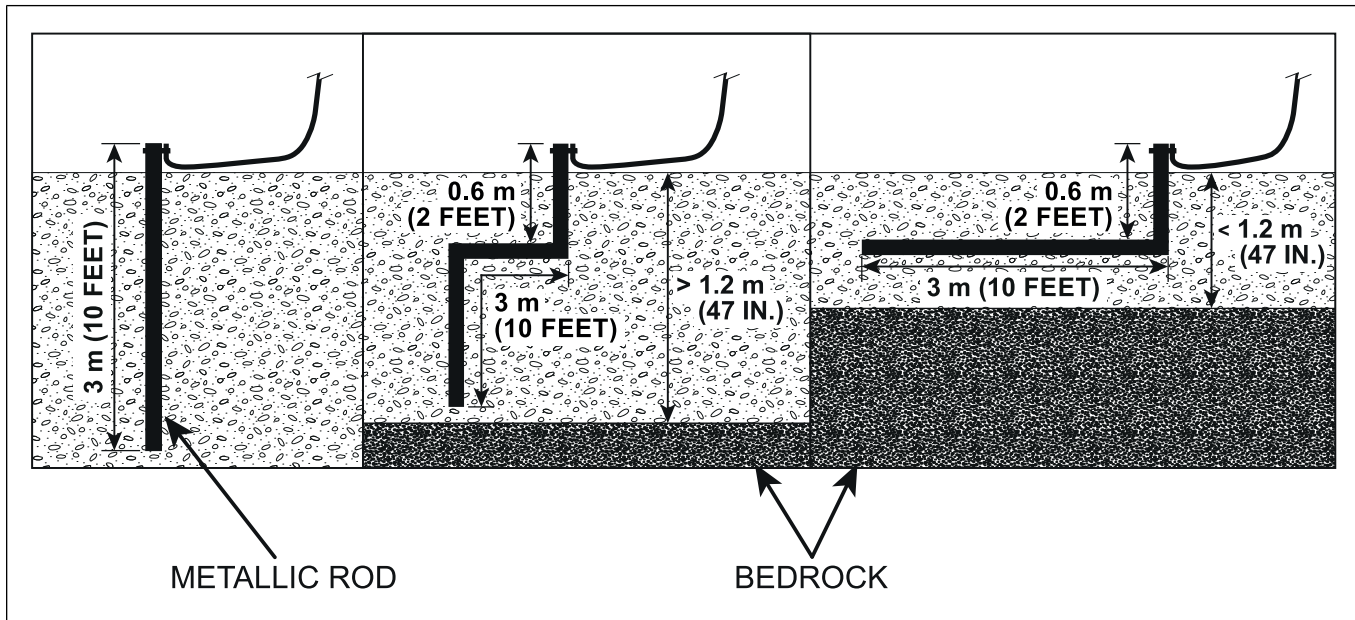

- If the bedrock is more than 3 meters (10 feet) below ground level, drive the grounding rod vertically 3 meters (10 feet) into the ground.
- If the bedrock is more than 1.2 meters (47 inches) below ground level, drive the rod into the ground to bedrock level and bury the remainder horizontally at least 0.6 meters (2 feet) below ground level.
- If the bedrock is less than 1.2 meters (47 inches) deep, bury the rod horizontally at least 0.6 meters (2 feet) below ground level.

NOTE: Refer to your local regulations and practices if an adequate grounding installation isn't possible.

Rod specifications for grounding

The rod specifications are guidelines only. Refer to your national and local regulations for compliance criteria.

Table 1-2 Grounding rod specifications

Item	Description
Material	Metallic, normally steel core.
Rod surface	The surface must be clean. It cannot be coated with paint, varnish or any non-conducting substance.
Minimum diameter	16 mm (5/8 inches)
Minimum length	2440 mm (8 feet)

Cable specifications for grounding

The cable specifications are guidelines only. Refer to your national and local regulations for compliance criteria.

Table 1-3 Grounding cable specifications

Item	Description
Certification and type	CSA, TEW type.

Chapter 1: Introduction

Table 1-3 *Grounding cable specifications (cont'd.)*

Item	Description
	UL, 1015 type, 12 AWG, 600 V, 105 °C (221 °F), green/yellow insulated wire.
Maximum length	15 meters (50 feet)
Suggested cable	Beldon # 9912, color code 189, or equivalent

2 Basic connections

Topics Covered in this Chapter

- Preparing the enclosures for installation
- Mounting the enclosures
- DC network or independent power supply connection
- Connecting the the KP-8IN-1REL, TP-8IN-1REL, TR-2IN-1REL to the communication network
- Connecting an analog input
- Connecting the relay output
- Grounding

Preparing the enclosures for installation

Preparing the equipment before mounting it to the wall facilitates manipulation and ensures all parts are ready to be installed.

Before You Begin

Wires are separated into two groups: low voltage and high voltage in the plastic enclosure and the conduits.

NOTE: *The use of rigid conduits up to 1 inch (25.4 mm) is allowed for the KP-8IN-1REL, TP-8IN-1REL, TR-2IN-1REL.*

1. With the enclosure closed, drill a hole the size of the your cable connectors or your rigid conduits at the bottom of the enclosure.
2. Open the enclosure by unscrewing the top, and remove the plastic fragments.
3. Install the cable connectors or rigid conduit adaptors to the bottom of each enclosure.
4. Close the enclosure using the screws.

IMPORTANT: *Leave the rated clearance to allow the cover to be removed for maintenance*

Remember

Do not mount the enclosures directly onto the drywall. If the supporting structure behind the drywall cannot support the enclosure, solidify it by adding a wooden or metal frame.

Mounting the enclosures

Securely mounting the enclosures to the wall in the ideal location allows for an optimal use of the system when using the OLED screen (KP-8IN-1REL, TP-8IN-1REL).

Before You Begin

NOTICE

When using outdoor connections, mount the enclosure as close as possible to the entry point of the wiring

IMPORTANT: *The enclosures must be mounted near an AC Power with a disconnecting switch*

IMPORTANT: *Mount the system into a wooden or metal frame. Do not mount the system directly into the drywall*

NOTE: *Install the enclosures (KP-8IN-1REL, TP-8IN-1REL) with the widest side of the screen placed horizontally. Consult the wiring diagram concerning wire length restrictions between the enclosures.*

NOTE: *GSI Electronics recommends this kind of screw: Deck Screw for Wood*

1. Place the enclosure at a height at which you can properly see the screen (KP-8IN-1REL, TP-8IN-1REL).
2. Screw in the top left hand corner screw first.
3. Using a level, make sure the enclosure is straight, and then screw in the second screw on the lower right hand corner.
4. Screw in the last two screws.

IMPORTANT: *Leave a clearance as stated in **Clearance around the system** to allow the cover to be removed for maintenance.*

DC network or independent power supply connection

Two possible configurations are available: DC network (available on the Agri Alert 128 Touch network) or the independent power supply. Depending on the DC network chosen, select the right wiring diagram for the installation.

NOTICE

*When tightening small terminal blocks, use a torque between 0.5N*m (4.43lbf*in) and 0.6 N*m (5.2lbf*in) to fasten a wire gauge from 16AWG to 18AWG.*

Connecting the DC network

SBI power can be used (pin 1 for 28VDC and pin 4 for GND) for suitable DC power.

DC network is available from the AA128 Touch network.

The recommended installation is 16 AWG for the power supply wires at a length of 300 meters (1000 feet).

1. Locate the Automation terminal on the KP-8IN-1REL, TP-8IN-1REL, TR-2IN-1REL you want to connect.
2. Connect the wires (24 or 28V and GND) from the KP-8IN-1REL, TP-8IN-1REL, TR-2IN-1REL. to the network.

Consult the wiring diagrams to see the maximum cable distance according to the wire gauge.

IMPORTANT: *Make sure to connect same identifications together and use the same network from one side to the other.*

IMPORTANT: *In the AA128 Touch network, use the Automation network on the KP-8IN-1REL, TP-8IN-1REL, TR-2IN-1REL.*

Connecting the independent power supply (PSU 24V 20W)

IMPORTANT: *Install a disconnect switch to interrupt power to L1 and N/L2 electric power lines before connecting the system's main input on the power supply. It must be in close proximity to the equipment and within easy reach of the operator. It must be marked as the disconnecting device for the equipment.*



If the disconnect switch or the circuit breaker is used as a sectioning device, the device must be correctly identified with which function of the controller opens the circuit. The Off or Stop and On position must be clearly identified on the sectioning device.

GSI Electronics recommends using a DPST disconnecting switch in series with a breaker. In the case of the use of a SPST disconnecting switch, connect the SPST disconnecting switch to cut the hot line with a neutral circuit case.



Disconnect supply before servicing

1. From the power source, follow the wiring diagram to connect the main voltage supply to the system's main inputs on the PSU 24V 20W.
2. Open the disconnecting switch or breaker before wiring.
3. Plug the wires (L1 to L1, L2/N to L2/N, Earth to Earth) from the PSU 24V 20W into a power source (main voltage supply).
4. Correctly ground the system by using a Functional Earth configuration.
5. From The PSU 24V 20W, connect the "+" in the 24V input and connect the "-" in the GND input on the KP-8IN-1REL, TP-8IN-1REL, TR-2IN-1REL.
6. Power on the system and make sure it is receiving power from the power source.

NOTE: *The working voltage range is between 90 Vac and 264 Vac. The system consumes a Power of 20 W on a PSU 24V 20W and the wires in accordance with local and national safety codes. A minimum voltage rating of 300V and a minimum temperature rating of 90°C is used for the wires.*

Connecting the the KP-8IN-1REL, TP-8IN-1REL, TR-2IN-1REL to the communication network

The communication bus enables communication between the AA128 Touch system and the KP-8IN-1REL, TP-8IN-1REL, TR-2IN-1REL (terminal A and terminal B on the Automation network).

What You Should Know

IMPORTANT: *These modules communicate at a higher bit rate than the old modules, TP800 and KP(B) 400. For this reason, they can't be connected to the SBI pins 2 and 3 of the Agri Alert 128 Touch, nor be daisy chained to an old module. A new wiring must be made using pin 1 and 4 of the SBI for power, and pin A and B of the PVX bus (located at position 11 and 12 on the Agri Alert 128 Touch base board, see wiring diagram).*

Chapter 2: Basic connections

1. Locate the **Automation** terminal on the KP-8IN-1REL, TP-8IN-1REL, TR-2IN-1REL you want to connect.
2. Connect the wires (A and B) from the KP-8IN-1REL, TP-8IN-1REL, TR-2IN-1REL to the network.

IMPORTANT: Make sure to connect same identifications together and use the same network from one side to the other.

IMPORTANT: The communication network must be installed in a daisy chain topology. Consult the wiring diagrams to see the maximum cable distance according to the wire gauge.

IMPORTANT: With the Agri Alert 128 Touch network, use the Automation network on the KP-8IN-1REL, TP-8IN-1REL, TR-2IN-1REL.

NOTICE

The recommended installation is 16 AWG for the power supply wires at a length of 300 meters (1000 feet). The recommended installation is 18 AWG for the communication wires at a length of 1200 meters (4000 feet). The cable must be twisted pair and shielded.

NOTICE

When tightening small terminal blocks, use a torque between $0.5N*m$ ($4.43lb*in$) and $0.6 N*m$ ($5.2lb*in$) to fasten a wire gauge from 16AWG to 18AWG.

The communication network must be installed in a daisy chain topology. The order of the wires is very important. At both ends of network, the End-of-Line must be activated. If the wiring can't be done in a single chain, you might need to deactivate the end-of-line (EOL) resistor to improve communication. GSI Electronics does not warranty the proper operation if the topology network is not daisy chain.

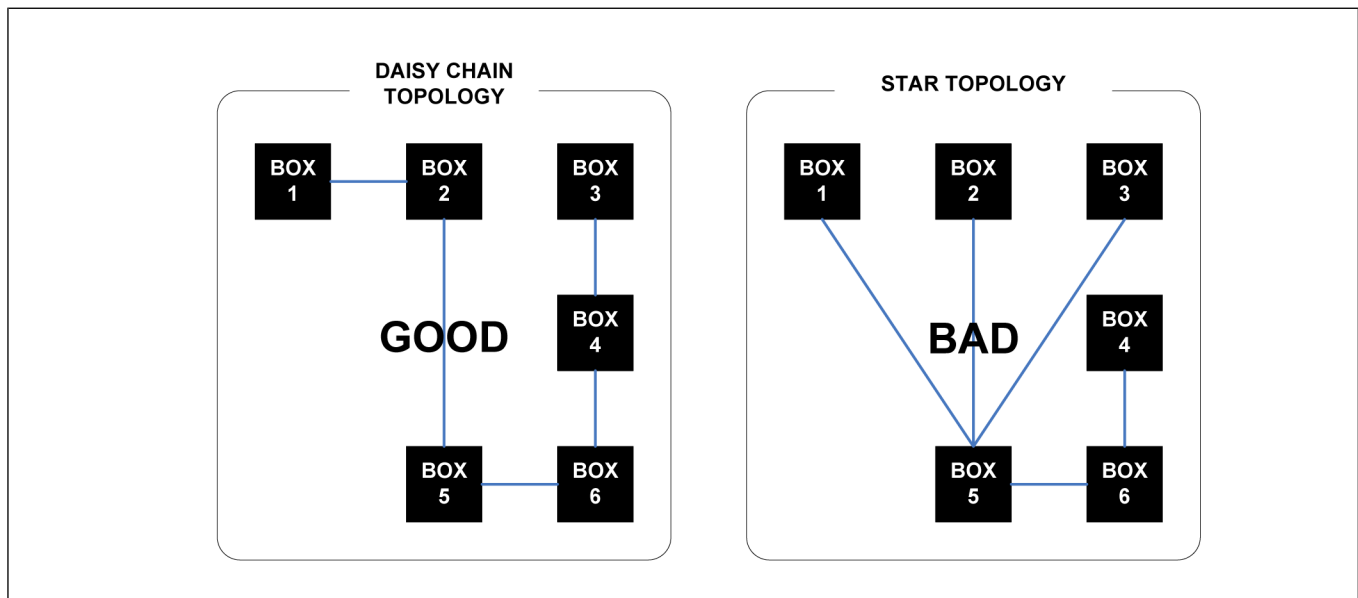

Connecting an analog input

A variety of different sensors can be hooked up to the system to monitor various inputs. Analog inputs can be set in 0-5V mode, in dry contact mode, in 4-20mA mode, and in temperature mode. Some

examples of sensors that you can use with the system: temperature probes, humidity probes, static pressure probes, water meters, dry contacts.

What You Should Know

NOTE: A minimum wire gage of 18 AWG (1 mm²) is required for a proper operating. The maximum cable length allowed (including cable extensions) is 150 m (500 feet). The cable must be twisted and shielded. Sensors needing a DC supply have the possibility to use 24 VDC outputs. Ensure to use the 24 VDC returns close to each 24 VDC output. The maximum current of each 24 VDC output is 50 mA.

IMPORTANT: Make sure each sensor is connected to the proper GND. False alarms can result if the wires are not properly connected.



Disconnect supply before servicing.



When wiring is complete, close the enclosure and secure it with the four screw.

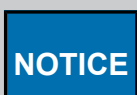

When tightening small terminal blocks, use a torque between 0.5N*m (4.43lbf*in) and 0.6 N*m (5.2lbf*in) to fasten a wire gauge from 16AWG to 18AWG.

Refer to the wiring diagrams for more information.

Connecting the relay output

Before You Begin

IMPORTANT: A disconnect switch must be installed to interrupt Power to L1 and N/L2 electric Power lines before connecting the system's main inputs on the relay outputs. It must be in close proximity to the equipment and within easy reach of the operator. It must be marked as the disconnecting device for the equipment. From the Power source, follow the wiring diagram to connect the main voltage supply to the relay output. GSI Electronics recommends using a DPST disconnecting switch in series with a breaker. In the case of the use of a SPST disconnecting switch, connect SPST disconnecting switch to cut the hot line with a neutral circuit case.



If the disconnecting switch or the circuit breaker is used as a sectioning device, the device must be correctly identified with which function of the controller opens the circuit. The Off or Stop and On position must be clearly identified on the sectioning device.



Disconnect supply before servicing

1. From the power source, follow the wiring diagram to connect the main voltage supply to the relay output.
2. Locate the "RELAY" terminals on the KP-8IN-1REL, TP-8IN-1REL, TR-2IN-1REL.

Chapter 2: Basic connections

3. Connect the voltage source (L1 or 24V or 28V) wire needed to switch in the terminal block named "RELAY – COM"
4. Connect one load from the relay output: terminal -RELAY - NO or terminal RELAY – NC.
5. From the load, connect to the main voltage supply return (L2/N) or the 24V return or the 28V return.

IMPORTANT: *The maximum voltage on the relay outputs is 240Vac. The maximum current allowed is 5A. The minimum permissible load on the relay outputs is 0,1A.*



Take note that the controller is not able to show the DC current value on the screen when a DC source is used but the electronic fusible of the relay can protect under a DC source.

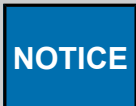

When tightening small terminal blocks, use a torque between 0.5N*m (4.43lbf*in) and 0.6 N*m (5.2lbf*in) to fasten a wire gauge from 16AWG to 18AWG.

See [Technical Specifications, page](#) to know the resistive load, motor load, and relay ratings according to the load used and the possible load configuration. Refer to your local building code to determine the type and quality of cable required. A minimum voltage rating of 300V and a minimum temperature rating of 90°C is used for the wires.

See Appendix Technical Specifications to know the resistive load, motor load, and relay ratings according to the load used and the possible load configuration. Refer to your local building code to determine the type and quality of cable required. A minimum voltage rating of 300V and a minimum temperature rating of 90°C is used for the wires.

GSI Electronics recommends the use of fuse in series at the output of a relay with a circuit breaker.

Grounding

The KP-8IN-1REL, TP-8IN-1REL, TR-2IN-1REL only needs a functional Earth.

The functional Earth connector is located at J2.



If metal rigid tubes are used, ensure they are correctly grounded.

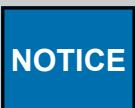

When tightening the Earth terminal blocks, use a torque from 0.9N*m (7.9lbf*in) to 1.0 N*m (8.9lbf*in) to fasten a wire gauge from 12AWG to 16AWG.

3 Maintenance

Topics Covered in this Chapter

- Inspecting and cleaning the enclosure
- Inspecting and tightening connections

Inspecting and cleaning the enclosure

Inspecting the enclosure and keeping them clean can help prolong the proper functioning of the module.

Before You Begin



Disconnect the voltage supply before servicing or performing any maintenance operations.



Screw the screw on the enclosure once the wiring is completed or when servicing.

- Every few months, open and inspect the enclosure for moisture or dust build-up.
- Using a damp cloth, wipe clean the exterior of the enclosure.

NOTE: *Do not spray water on the controller.*

Inspecting and tightening connections

At some point, the connections must be verified to ensure they are not loose and that the installation is always safe. The inspection ensures that no overheating occurs on the tightening connections. GSI Electronics recommends verifying the connections on power and control terminals every 3-12 Months. The torques are stated in the manual where tightening torque is required according to the specific terminal.

NOTES

4 Troubleshooting

Problem	Solution
The KP-8IN-1REL or TP-8IN-1REL or TR-2IN-1REL does not communicate	Verify if the controller is powered up
	Verify if there is any activity on the communication bus by looking at the LEDs: AUTOMATION-RX, AUTOMATION-TX, SAFETY-RX, SAFETY-TX.
	Verify if the network link is installed correctly: Terminal A from The KP-8IN-1REL or TP-8IN-1REL or TR-2IN-1REL to the Main Controller terminal A, Terminal B from The KP-8IN-1REL or TP-8IN-1REL or TR-2IN-1REL to the Main Controller terminal B
	Verify if the network communication is installed in daisy chain.
	Verify if your end of line (EOL) are set correctly on your network.
	Verify if the network link is cut (either the wire is cut or the protections are activated).
	Verify if there is a short-circuit on the network link between terminal A and B.
	Verify if the network link length is below 4000 feet (1200m) with the recommended gage.
	Measure the voltage between terminal 24V and GND. The voltage must be at least 16V.
	If the problem persists, contact your dealer or GSI Electronics.
The KP-8IN-1REL or TP-8IN-1REL or TR-2IN-1REL does not power up	Verify if the LED "3.3V" or "5V" is activated on PCB-434.
	Measure the voltage between terminal 24V and GND. The voltage must be at least 16V.
	Verify if the power link is installed correctly: Terminal 24V from The KP-8IN-1REL or TP-8IN-1REL or TR-2IN-1REL to the Main Controller terminal 24V, Terminal GND from The KP-8IN-1REL or TP-8IN-1REL or TR-2IN-1REL to the Main Controller terminal GND.
	Verify if the power link is cut (wire is cut).
	Verify if the power link length is below 300 feet (1000m) with the recommended gage.
	If the problem persists, contact your dealer or GSI Electronics.
The KP-8IN-1REL or TP-8IN-1REL or TR-2IN-1REL does not still power up	Verify if the LED "3.3V" or "5V" is activated on PCB-434.
	Measure the voltage between terminal 24V and GND. The voltage must be at least 16V.
	Verify if the power link is installed correctly: Terminal 24V from The KP-8IN-1REL or TP-8IN-1REL or TR-2IN-1REL to the Main Controller terminal 24V, Terminal GND from The KP-8IN-1REL or TP-8IN-1REL or TR-2IN-1REL to the Main Controller terminal GND.
	Verify if the power link is cut (wire is cut).
	Verify if the power link length is below 300 feet (1000m) with the recommended gage.
	If the problem persists, contact your dealer or GSI Electronics.
Relay does not activate the load	Verify if the LED 4 is activated on PCB-434.
	Verify the wiring if the right contact is used correctly.
	Verify if the load does not activate the protection. The current must be below 5A and higher than 0.1A.
	If there is an overload, find out the issue and solve it and reset the electronic fuse by resetting it on the Main controller software.

Chapter 4: Troubleshooting

	Verify if the load link is not cut.
	Verify if a voltage supply reach the terminal RELAY-COM.
	If the problem persists, contact your dealer or GSI Electronics.
Issues with inputs sensors	Verify if the sensor wiring is conformed to the wiring diagrams.
	Verify if the sensor is connected at the right terminal.
	Verify if the sensor configuration is set correctly on the Main Controller.
	If the problem persists, contact your dealer or GSI Electronics.
Issues with the 24Vdc output	The 24Vdc output is not able to control the device. Ensure that the 24Vdc output does not draw more than 50mA.
	Verify if the sensor wiring is conformed to the wiring diagram.
	If the problem persists, contact your dealer or GSI Electronics.

A Navigating through the KP-8IN-1REL

There are three different ways to navigate through the KP-8IN-1REL depending on the state.

Figure A-1 Navigation when state is idle

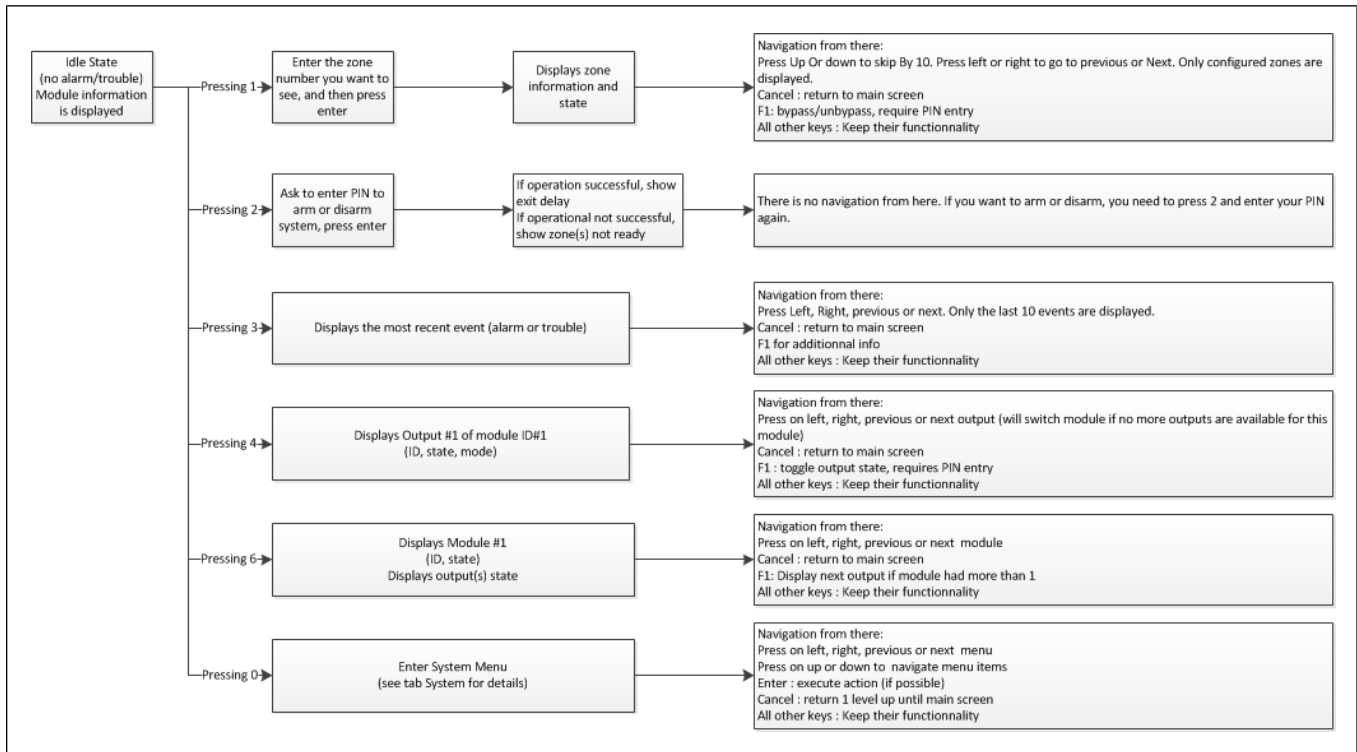

Figure A-2 Navigation when in alarm state

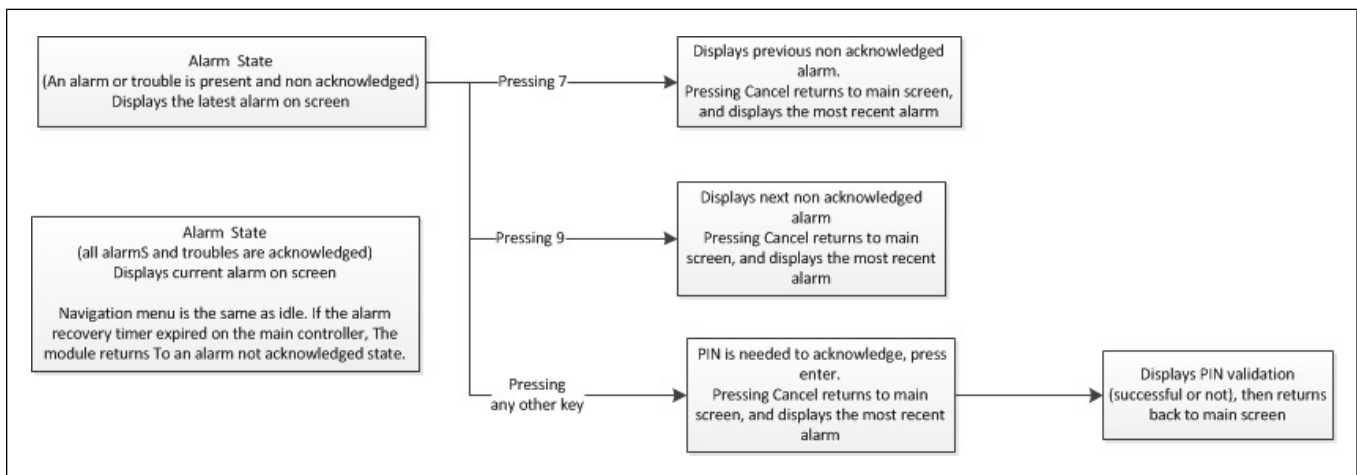
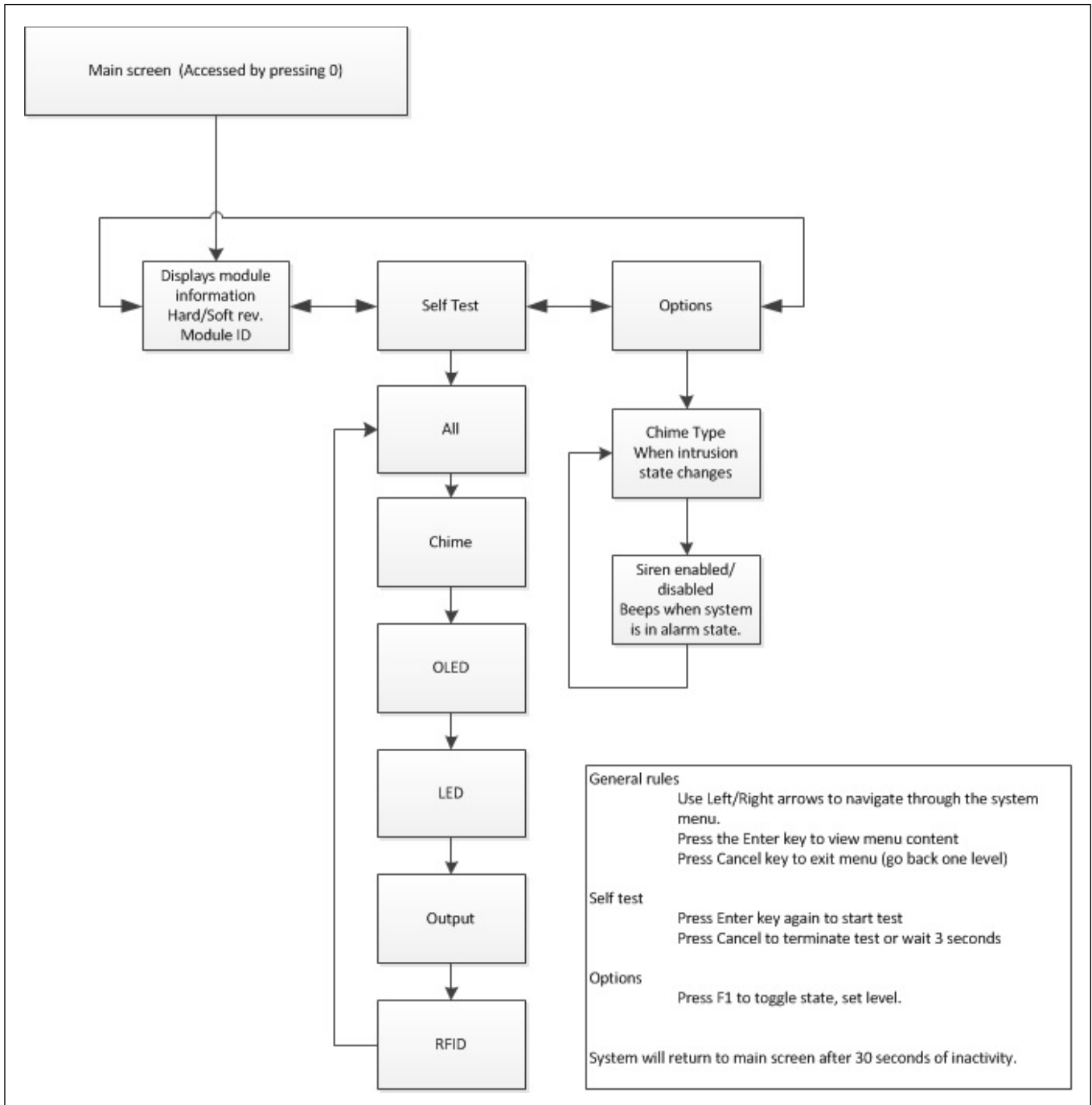

Figure A-3 Navigation in system menus



B LED meaning

KP-8IN-1REL, TP-8IN-1REL, TR-2IN-1REL

LED identification	Description
5V on PCB-434	Led active when the 5Vdc is present
3.3V on PCB-434	Led active when the 3.3Vdc is present
LED1 on PCB-434	Debug LEDs
LED2 on PCB-434	
AUTOMATION-RX on PCB-434	Led blinks off during activity
AUTOMATION-TX on PCB-434	Led blinks off during activity
SAFETY-RX on PCB-434	Led blinks off during activity
SAFETY-TX on PCB-434	Led blinks off during activity
LED 4 on PCB-434	Led active when the relay is activated
LED1 on PCB-435	Leds Feedback for 24V and Comm. Status
LED2 on PCB-435	
LED3 on PCB-435	
LED4 on PCB-435	
LED5 on PCB-435	
LED6 on PCB-435	
LED7 on PCB-435	
LED8 on PCB-435	
LED9 on PCB-435	
LED10 on PCB-435	Debug LEDs (and board ID)

NOTES

C List of terminals

KP-8IN-1REL, TP-8IN-1REL, TR-2IN-1REL

Terminal name	Description
RELAY - COM	Relay input, the COM (Common) is the voltage source needed to switch
RELAY - NO	Relay output, When a relay contact is normally open (NO), there is an opened contact when the relay is not energized.
RELAY - NC	Relay output, When a relay contact is Normally Closed (NC), there is a closed contact when the relay is not energized.
FUNCTIONAL EARTH	Functional Ground Terminal Primarily used for functional earth terminals which are generally associated with test and measurement circuits. These terminals are not for safety earthing purposes but provide an earth reference point.
AUTOMATION - 24V	Communication bus 1 - Power supply 24Vdc
AUTOMATION - A	Communication bus 1 - Signal A of RS485 communication
AUTOMATION - B	Communication bus 1 - Signal B of RS485 communication
AUTOMATION - GND	Communication bus 1 - Power supply return
SAFETY - 24V	Communication bus 2 - power supply 24Vdc
SAFETY - A	Communication bus 2 - Signal A of RS485 communication
SAFETY - B	Communication bus 2 - Signal B of RS485 communication
SAFETY - GND	Communication bus 2 - Power supply return
IN(x)	Analog inputs can set in 0-5V mode, in dry contact mode, in 4-20mA mode, in temperature mode. Inputs are used for sensors : temperature probes, humidity probes, static pressure probes, water meters, dry contacts.
GND(x) close to IN(x)	Analog inputs returns. Inputs are used for sensors : temperature probes, humidity probes, static pressure probes, water meters, dry contacts.
24Vout	24Vdc output, 50mA

NOTES

D Technical Specifications

Weight and dimensions		
KP-8IN-1REL Weight	861,83 grams (1.90 lbs)	
TP-8IN-1REL Weight	861,83 grams (1.90 lbs)	
TR-8IN-1REL Weight	816.47 grams (1.80 lbs)	
Enclosure dimensions	Height	178 mm (7 inches)
	Width	229 mm (9 inches)
	Depth	76.2 mm (3 inches)
Clearance around the enclosure	Top	152mm (6 inches)
	Bottom	152mm (6 inches)
	Sides	152mm (6 inches)

Table D-1 Safety ratings

Inputs:	
KP-8IN-1REL Supply Input	24/28Vdc, 5.62W
TP-8IN-1REL Supply Input	24/28Vdc, 4.72W
TR-2IN-1REL Supply Input	24/28Vdc, 4.3W
Outputs:	
Motor/inductive loads	<p>5 A MAX</p> <p>(Nb of Units = Max current rating divide by the max current of the fan multiply by its service factor will give you the number of this fan type the relay can drive)</p> <p>For example, $5A / (2.5 A * 1.5 SF) = 1.3$, relay can drive up to 1 fan Minimum load of 0.2A</p> <p>50/60Hz 120Vac ,1/6HP (124W)</p>
Resistive loads (electric heating element)	150Vac Max. / 28/24 VAC/DC, 5A max. Minimum load of 0.2A
Tungsten loads loads (incandescent and heat lamp)	<p>120 Vac, 2A max.</p> <p>Minimum load of 0.2A</p>
DC loads	<p>24Vdc, 5A max.</p> <p>(The current reading is not available in DC) Minimum load of 0.2A)</p>

Table D-2 Functional ratings

Inputs:	
Temperature	<p>Compliant to GSIE temperature probes, Accuracy of $\pm 0.1^{\circ}\text{C}$ in a normal operation,</p> <p>Allowable loss of performance in a noisy environment:</p>

Appendix D: Technical Specifications

Table D-2 Functional ratings (cont'd.)

	Accuracy of $\pm 0.65^{\circ}\text{C}$ from initial reading with a fixed resistor of 1% precision used for testing purpose.
Analog 0-5 Volts	Sensor must be able to drive a 2k Ohms load, which means the sensor must drive at least 2.5mA to ensure correct readings. Accuracy of $\pm 30\text{mV}$ in a normal operation, Allowable loss of performance in a noisy environment: Accuracy of $\pm 80\text{mV}$ from initial reading with a voltage source of 1% precision used for testing purpose.
Analog 4-20mA	Sensor must be able to drive a 120 Ohms load Maximum rating: 20.8mA, 2.5V Accuracy of $\pm 0.2\text{mA}$ in a normal operation Allowable loss of performance in a noisy environment: Accuracy of $\pm 0.4\text{mA}$ from initial reading with a current source of 1% precision used for testing purpose.
Dry contact	Close contact resistance must be lower than 200 Ohms Open contact resistance must be higher than 100k Ohms
Water meter, Pulse speed	Max 100Hz, pulse width minimum of 3.2ms Max 100 Ohms (close contact) and min. 100k Ohms (open contact) including the value of the wire resistance
Relay outputs with current sensing input	Accuracy of $\pm 0.5\text{A}$ for AC load $< 5\text{A}$ in a normal environment Allowable loss of performance in a noisy environment: Accuracy of $\pm 0.75\text{A}$ from initial reading with a load of 1% precision used for testing purpose
Outputs:	
24Vdc	24 Vdc, 50 mA max
Operational ratings	
Operating Temperature	-40 to 40°C (-40 to 104°F)
Storage Temperature	-20 to 50°C (-4 to 122°F)
Environment Type	Indoor and outdoor use
Pollution Degree	2
Installation Category	2
Altitude	2000 Meters Max. (6561 Ft. Max)
Operating Relative Humidity (maximum)	-40 to 0°C (-40 to 32°F) Non condensing 0 to 10°C (32 to 50°F) Non condensing 10 to 30°C (50 to 86°F) 95 % (± 3 %) Non condensing 30 to 40°C (86 to 104°F) 95 % (± 3 %) Non condensing

Table D-2 Functional ratings (cont'd.)

IP rating (IEC 60529)	66
Nema Rating (Nema 250)	4X
Flame Rating (UL94)	5VA V-0
Flame Rating (IEC 60695 or IEC 60707)	FV-0
IK rating (degree of mechanical protection - impact, IEC 62262)	08

Table D-3 Telecommunication ratings for RFID module (Only on KP-8IN-1REL and TR-2IN-1REL)

Protocol Handling	ISO15693	
Output Power	+20 dBm (100 mW)	
System Clock Frequency Output	13.56MHz	
Equipment type (ETSI EN 301 489-3)	III	Others : Identification/Access control
Class type (ETSI EN 301 489-3)	2	(Medium reliable SRD communication media; e.g. causing inconvenience to persons, which cannot simply be overcome by other means)

NOTES

E Safety Characteristics and Certification

Safety characteristics

The controllers are Safety Class I according to IEC classification and has been designed to meet the requirements of UL 61010-1 third edition, CAN/CSA-C22.2 n° 61010-1 third edition, EN 61010-1: 2010 (Safety Requirements for Electrical Equipment for Measurement, Control and Laboratory Use). It is an Installation Category II intended for operation from a normal single phase supply.

The controllers have been tested in accordance with IEC61010-1 and have been supplied in a safe condition. This instruction manual contains some information and warnings which have to be followed by the user to ensure safe operation and to retain the instrument in a safe condition.

These Safety EU directives were followed:

2014/35/EU	The low voltage directive (LVD)
2014/30/EU	The Electromagnetic compatibility directive (EMC)

NOTE: *KP-8IN-1REL, TP-8IN-1REL, TR-2IN-1REL plastic Enclosure is certified to use rigid tubing up to 1 inch.*

EMC characteristics — emission standards

The controllers have been designed to meet the requirements of the EMC Directive 2014/30/EU, the FCC directives, the Industry Canada directives. The compliance was demonstrated by meeting the test limits of the following standards:

EN 61000-6-4 (2007/A1:2011)	Emission tests levels for industrial environment
EN61326-1 (2013)	EMC product standard for Electrical Equipment for Measurement, Control and Laboratory Use
IEC EN 60730-1 (2010):	Automatic electrical controls for household and similar use - Part 1: General requirements - EMC requirements
FCC part 15 Subpart B	Class A
EMC certification: ICES-001	Industrial, Scientific and Medical (ISM) Radio Frequency Generators – class A
ETSI EN 301 489-1 V1.9.2 (2011-09)	Electromagnetic compatibility and Radio spectrum Matters (ERM); ElectroMagnetic Compatibility (EMC) standard for radio equipment and services; Part 1: Common technical requirements
ETSI EN 301 489-3 V1.6.1 (2013-06)	Electromagnetic compatibility and Radio spectrum Matters (ERM); ElectroMagnetic Compatibility (EMC) standard for radio equipment and services; Part 3: Specific conditions for Short-Range Devices (SRD) operating on frequencies between 9 kHz and 40 GHz

Appendix E: Safety Characteristics and Certification

Test number	Test name	Standard	Standard level
1	Conducted emissions	CISPR 11 : 2009 A1 (2010) FCC part 15, sub-part B : 2012	Group 1, class A Class A
2	Radiated emissions	CISPR 11 : 2009 A1 (2010) FCC part 15, sub-part B : 2012	Group 1, class A Class A

EMC characteristics — immunity standards

The controllers have been designed to meet the requirements of the EMC Directive 2014/30/EU, the FCC directives, the Industry Canada directives. The compliance was demonstrated by meeting the test limits of the following standards:

EN61326-1 (2013)	EMC product standard for Electrical Equipment for Measurement, Control and Laboratory Use
EN 61000-6-2 (2006):	Immunity tests levels for industrial environment
IEC EN 60730-1 (2010):	Automatic electrical controls for household and similar use - Part 1: General requirements - EMC requirements
FCC part 15 Subpart B	Class A
ETSI EN 301 489-1 V1.9.2 (2011-09)	Electromagnetic compatibility and Radio spectrum Matters (ERM); ElectroMagnetic Compatibility (EMC) standard for radio equipment and services; Part 1: Common technical requirements
ETSI EN 301 489-3 V1.6.1 (2013-06)	Electromagnetic compatibility and Radio spectrum Matters (ERM); ElectroMagnetic Compatibility (EMC) standard for radio equipment and services; Part 3: Specific conditions for Short-Range Devices (SRD) operating on frequencies between 9 kHz and 40 GHz

Test number	Test name	Standard	Standard level
5	Radiated, radio-frequency, electromagnetic field immunity test	EN61000-4-3 : 2006 A1 : 2007 A2 : 2010	Modulation: 80% AM at 1kHz, 80MHz - 1GHz: 10V/m 1.4GHz-2 GHz: 3 V/m 2GHz-2.7GHz: 3V/m Performance: A (A)
6	Immunity to conducted disturbances, induced by radio-frequency fields	EN61000-4-6 : 2008	Frequency test range : 150KHz and 80Mhz at 10Vrms Pause time: 0,5s (AC line, Earth, I/O connections >3m) Performance A (A)
7	Electrostatic discharge immunity test	EN61000-4-2 : 2008	± 8 kV air ± 6kV contact Performance A (B)
8	Electrical fast transient/ burst immunity test	EN 61000-4-4 : 2012	±2kV/5kHz on the main sector ±1kV/5kHz on the I/O >3m Performance A (B)
9	Surge immunity test	EN61000-4-5 : 2005	On the main sector : L-PE : ±2kV L-L : ±1kV I/O : L-PE : ±1kV L-L : ±1kV
10	Power frequency magnetic field immunity test	EN 61000-4-8 : 2009	30 A/m, Performance A (B)

The definitions of performance criteria are as follows:

Appendix E: Safety Characteristics and Certification

- Performance criterion A — During test normal performance within the specification limits
- Performance criterion B — During test, temporary degradation, or loss of function or performance which is self-recovering
- Performance criterion C — During test, temporary degradation, or loss of function or performance which requires operator intervention or system reset occurs.

The performance level A may be replaced by a permissible loss of performance. Following parameters define the permissible loss of performance during immunity test. These parameters will not affect or degrade the functional performance of the product.

KP-8IN-1REL, TP-8IN-1REL, TR-2IN-1REL element	Normal operation	Allowable loss of performance
Analog input configured in temperature mode	Accuracy of $\pm 0.1^{\circ}\text{C}$	Accuracy of $\pm 0.65^{\circ}\text{C}$ from initial reading with a fixed resistor of 1% precision used for testing purpose.
Analog input configured in 4-20mA mode	Accuracy of $\pm 0.2\text{mA}$	Accuracy of $\pm 0.4\text{mA}$ from initial reading with a current source of 1% precision used for testing purpose.
Analog input configured in 0-5V mode	Accuracy of $\pm 30\text{mV}$	Accuracy of $\pm 80\text{mV}$ from initial reading with a voltage source of 1% precision used for testing purpose.
Relay outputs with current sensing	Accuracy of $\pm 0.5\text{A}$ for AC load $< 5\text{A}$	Accuracy of $\pm 0.75\text{A}$ from initial reading with a load of 1% precision used for testing purpose
OLED display	No visual degradation	No visual degradation
RS485 link	1 communication frame loss	3 consecutive communication frames losses

Class type (ETSI EN 301 489-3)		
Criteria	During test	After test
A	Operate as intended No loss of function For equipment type II the minimum performance shall be 6 dB SINAD No unintentional responses	Operate as intended For equipment type II the communication link shall be maintained No loss of function No degradation of performance No loss of stored data or user programmable functions
B	May be loss of function (one or more) No unintentional responses	Operate as intended Lost function (s) shall be self-recoverable No degradation of performance No loss of stored data or user programmable functions

RFID functional characteristics

The RFID module is designed and tested to meet the following requirements:

Appendix E: Safety Characteristics and Certification

FCC 47 CFR Part 15.225	Operation within the band 13.110–14.010 MHz
RSS-210 Issue 8, December 2010, Annex 2.6	Spectrum Management and Telecommunications Radio Standards Specification; Licence-exempt Radio Apparatus (All Frequency Bands): Category I Equipment
ETSI EN 300 330-2 V1.6.1 (2015-03)	Electromagnetic compatibility and Radio spectrum Matters (ERM); Short Range Devices (SRD); Radio equipment in the frequency range 9 kHz to 25 MHz and inductive loop systems in the frequency range 9 kHz to 30 MHz; Part 2: Harmonized EN covering the essential requirements of article 3.2 of the R Directive

Environment characteristics

Parameter	Condition	Value
Environment Location	Inside and outside	
Temperature	Operating	-40 to 40°C (-40 to 104°F)
	Storage	-20 to +50 °C (-4 to +122 °F)
Humidity (Maximum Relative)	-40 to 0°C (-40 to 32°F)	Non condensing
	0 to 10 °C (32 to 50 °F)	Non condensing
	10 to 30 °C (50 to 86 °F)	95 % (± 3%) Non condensing
	30 to 40 °C (86 to 104 °F)	95 % (± 3%) Non condensing
	Storage	Non condensing
Altitude		2000 Meters Max. (6561 Ft. Max)
Electromagnetic Environment		EN/IEC61326-1 IEC EN 60730-1 EN 61000-6-4 EN 61000-6-2 ETSI EN 301 489-1 ETSI EN 301 489-3
Enclosure Protection		Nema 250 : type 4xIP : 66, ref : IEC60529
Impact rating (IK)		08

The controllers were tested under IEC60068-1 (Environmental testing - Part 1: General and guidance)

Environmental characteristics

These Environmental EU directives were followed:

2011/65/EU	The RoHS 2 Directive
2012/19/EU	The WEEE 2 Directive
1907/2006/EU	The REACH regulation
2006/66/EC	The Battery Directive
94/62/EC	Packaging and packaging waste Directive
97/129/EC	Packaging material identification Directive

F EC Declaration of Conformity (In accordance with EN ISO 17050-1 2004)

We: GSI Electronics Inc.

Of: 5200, Armand-Frappier, Saint-Hubert (Québec), Canada, J3Z 1G5

In accordance with the following directives:

2014/35/EU The Low Voltage Directive (LVD)

2014/30/EU The Electromagnetic Compatibility Directive (EMC)

1999/5/EC The Radio & Telecommunication Terminal Equipment Directive (R&TTE)

2011/65/EU The RoHS 2 Directive

2012/19/EU The WEEE 2 Directive

1907/2006/EC The REACH regulation

2006/66/EC The Battery Directive

94/62/EC Packaging and packaging waste Directive

97/129/EC Packaging material identification Directive

Hereby declare that:

Equipment: The Modules KP-8IN-1REL, TP-8IN-1REL, TR-2IN-1REL are used in an Edge system or AA128 Touch system. The modules are used in a farm system network designed to monitor and to control of a farm environment. The main functions of monitoring or controlling are: ventilation control, heating control, lighting control, animal feeding control, scale control, quality air control, alert function.

Model numbers:

KP-8IN-1REL, TP-8IN-1REL, TR-2IN-1REL

is in conformity with the applicable requirements of the following documents:

Directive	Ref. No	Title	Edition/date
LVD	EN 61010-1	Safety requirements for electrical equipment for measurement, control, and laboratory use Part 1: General requirements	2010
R	ETSI EN 300 330-2	Electromagnetic compatibility and Radio spectrum Matters (ERM); Short Range Devices (SRD); Radio equipment in the	V1.6.1 (2015-03)

		frequency range 9 kHz to 25 MHz and inductive loop systems in the frequency range 9 kHz to 30 MHz; Part 2: Harmonized EN covering the essential requirements of article 3.2 of the R Directive	
EMC	ETSI EN 301 489-1	Electromagnetic compatibility and Radio spectrum Matters (ERM); Electro-Magnetic Compatibility (EMC) standard for radio equipment and services; Part 1: Common technical requirements	V1.9.2 (2011-09)
EMC	ETSI EN 301 489-3	Electromagnetic compatibility and Radio spectrum Matters ERM); Electro-Magnetic Compatibility (EMC) standard for radio equipment and services; Part 3: Specific conditions for Short-Range Devices (SRD) operating on frequencies between 9 kHz and 40 GHz	V1.6.1 (2013-06)
EMC	EN 61326-1	Electrical equipment for measurement, control and laboratory use - EMC requirements	2013
EMC	EN 61000-6-2	Immunity tests levels for industrial environment EN 61000-4-2 EN 61000-4-3 EN 61000-4-4 EN 61000-4-5 EN 61000-4-6 EN 61000-4-8	2006 2009 2006 A1 (2007) A2 (2010) 2012 2014 2008 2010
EMC	EN 61000-6-4	Emission tests levels for industrial environment CISPR11 /EN 55011	2009 + A1: 2010 2007/A1:2011 2006 +A1 (2009)+ A2 (2009) 2008

			(2009)+A1 (2010)
EMC	IEC EN 60730-1	Automatic electrical controls for household and similar use - Part 1: General requirements- EMC requirements Immunity and emission part CISPR11 /EN 55011 EN 61000-4-2 IEC EN 61000-4-3 EN 61000-4-4 IEC EN 61000-4-5 IEC EN 61000-4-6 EN 61000-4-8	2010 (2009)+A1 (2010) 2009 2006 A1 (2007) A2 (2010) 2012 2014 2008 2010
RoHS	EN 50581	Technical documentation for the assessment of electrical and electronic products with respect to the restriction of hazardous substances	2012

GSI Electronic Inc. hereby declares that the equipment named above has been designed to comply with the relevant sections of the above referenced specifications. The unit complies with all applicable Essential Requirements of the Directives.



NOTES

G FCC part 15 statement

Statement regarding the importation of radio frequency devices capable of causing harmful interference.

GSI Electronics Inc. develops, manufactures and distributes innovative technological products for the agricultural industry. Our unique expertise allows us to offer accurate, simple and diverse electronic, data processing and mechanical solutions for improving agricultural production.

Electronic controllers use radiation-emitting technology: RFID (Radio Frequency Identification). This wireless technology is used by GSI Electronics to control the access to the barn. Electronic controllers are classed as intentional radiators (FCC 47-part 15-Subpart C). The RFID Module respects the emission limitations and the performances required by the standards FCC 15.225, RSS-210 Annex 2.6, ETSI 300 330. Electronic controllers are used in a production context and in an industrial context (FCC 47-part 15-Subpart B- Class A).

GSI Electronics Inc. hereby declares that the equipment has been tested and found to comply with the limits for a Class A digital device, pursuant to part 15 of the FCC Rules.

This device complies with part 15 of the FCC Rules. Operation is subject to the following two conditions: (1) This device may not cause harmful interference, and (2) this device must accept any interference received, including interference that may cause undesired operation.

These limits are designed to provide reasonable protection against harmful interference when the equipment is operated in a commercial environment. This equipment generates, uses, and can radiate radio frequency energy and, if not installed and used in accordance with the instruction manual, may cause harmful interference to radio communications. Operation of this equipment in a residential area is likely to cause harmful interference in which case the user will be required to correct the interference at his own expense.

If this equipment does cause harmful interference to radio or television reception, which can be determined by turning the equipment off and on, the user is encouraged to try and correct the interference by one or more of the following measures:

- Reorient or relocate the receiving antenna (RFID Module).
- Increase the separation between the equipment and receiver.
- Connect the equipment into an outlet on a circuit different from that to which the receiver is connected.
- Consult GSI Electronics

NOTES

H FCC RF exposure statement

Statement regarding the importation of radio frequency devices capable of causing radiation exposure

GSI Electronics Inc. develops, manufactures and distributes innovative technological products for the agricultural industry. Our unique expertise allows us to offer accurate, simple and diverse electronic, data processing and mechanical solutions for improving agricultural production.

The RFID module uses radiation-emitting technology: emission at 13.56-MHz. The RFID module is classed as intentional radiators (FCC 47-part 15-Subpart C). This equipment complies with FCC radiation exposure limits set forth for an uncontrolled environment. This equipment should be installed and operated with minimum distance 20 cm between the radiator and your body. This transmitter must not be co-located or operating in conjunction with any other antenna or transmitter.

NOTES

Innovation, Science and Economic Development Canada ICES-003 Compliance CAN ICES-3 (A)/NMB-3(A)

This device complies with Industry Canada licence-exempt RSS standard(s). Operation is subject to the following two conditions: (1) this device may not cause interference, and (2) this device must accept any interference, including interference that may cause undesired operation of the device.

Le présent appareil est conforme aux CNR d'Industrie Canada applicables aux appareils radio exempts de licence. L'exploitation est autorisée aux deux conditions suivantes : (1) l'appareil ne doit pas produire de brouillage, et (2) l'utilisateur de l'appareil doit accepter tout brouillage radioélectrique subi, même si le brouillage est susceptible d'en compromettre le fonctionnement.

Innovation, Science and Economic Development Canada ICES-003 Compliance CAN ICES-3 (A)/NMB-3 (A)

IMPORTANT: *Radiation Exposure Statement: This equipment complies with IC radiation exposure limits set forth for an uncontrolled environment. This equipment should be installed and operated with minimum distance 20cm between the radiator and your body.*

IMPORTANT: *Déclaration d'exposition aux radiations: Cet équipement est conforme aux limites d'exposition aux rayonnements IC établies pour un environnement non contrôlé. Cet équipement doit être installé et utilisé avec un minimum de 20 cm de distance entre la source de rayonnement et votre corps.*

NOTES

J FDA declaration

Statement regarding the importation of devices and public health hazard directives from FDA (U.S. Food and Drug Administration)

GSI Electronics Inc. develops, manufactures and distributes innovative technological products for the agricultural industry. Our unique expertise allows us to offer accurate, simple and diverse electronic, data processing and mechanical solutions for improving agricultural production.

GSI Electronics' controllers are shipping under 9032.89.60.30 Canada (Automatic Regulating or Controlling Instruments & Apparatus). Electronic controllers are used to monitor and to control animal environment in a barn: ventilation function; heating function; lightning function; alert system function. Electronic controllers can be used to control the food distribution and to scale animals.

Electronic controllers do not use laser technologies. Electronic controllers use liquid crystal display (LCD) or Light-emitting diodes (LED). It is important to note also that electronic controller incorporating Liquid Crystal Displays (LCD) or Light-emitting diodes (LED) are not capable of emitting x-radiation.

Electronic controllers use radiation-emitting technology: RFID (Radio Frequency Identification). This wireless technology is used by GSI Electronics to control the access to the barn. Electronic controllers are classed as intentional radiators (FCC 47-part 15-Subpart C). The RFID Module respects the emission limitations and the performances required by the standards FCC 15.225, RSS-210 Annex 2.6, ETSI 300 330. Electronic controllers are used in a production context and in an industrial context (FCC 47-part 15-Subpart B- Class A).

GSI Electronics devices are not used in contact with animal food. Electronic controllers do not manipulate vaccines or drugs.

As such these products and are not subject to the FDA standards and do not pose a public health hazard.

NOTES

K Reduction of Hazardous Substances

REACH directive

The REACH directive addresses the production and use of chemical substances, and their potential impacts on both human health and the environment. On June 1, 2007, the European Commission promulgated new legislation that covers the registration, evaluation, authorization and restriction of chemical within the European Union community. This new regulation is commonly known as REACH, an acronym for **R**egistration, **E**valuation and **A**uthorization of **C**hemicals (EC Regulation 1907/2006).

GSI Electronics supports the underlying goals of REACH, which are consistent with our own commitment to promote the responsible manufacturing, use and handling of chemicals. GSI Electronics uses and promotes components suppliers or components manufacturers who will meet the pre-registration deadline for all chemical substances in quantities greater than one metric ton. The information provided here is accurate to the best of our knowledge at the present time.

RoHS directive

The **R**estriction of **H**azardous **S**ubstances Directive 2002/95/EC, RoHS, Directive on the restriction of the use of certain hazardous substances in electrical and electronic equipment, was adopted in February 2003 by the European Union. The RoHS directive took effect on 1 July 2006, and is required to be enforced and become law in each member state. This directive restricts (with exceptions) the use of six hazardous materials in the manufacture of various types of electronic and electrical equipment: Lead (Pb), Mercury (Hg), Cadmium (Cd), Hexavalent chromium (Cr6+), Polybrominated biphenyls (PBB), Polybrominated diphenyl ether (PBDE). The RoHS 2 directive (2011/65/EU) is an evolution of the original directive and became law on 21 July 2011 and took effect 2 January 2013. It addresses the same substances as the original directive while improving regulatory conditions and legal clarity.

GSI Electronics hereby certifies that all components are RoHS Compliant and fulfills the definition and restrictions defined under Directive 2011/65/EU of the European Parliament and of the Council of June 8, 2011 on the restriction of the use of certain hazardous substances in electrical and electronic equipment (EEE). The information provided here is accurate to the best of our knowledge at the present time.

The RoHS declaration is available, contact GSI Electronics or the European representative.

Battery directive

The Battery Directive, Directive 2006/66/EC (Previous Directive, Directive 91/157/EEC), of the European Parliament regulates the manufacture, the disposal, the recycling of batteries and accumulators in the European Union.

GSI Electronics uses Lithium cell button in a light industrial context or industrial context. GSI Electronics encourages the batteries and accumulators recycling.

NOTES

L Disposal and Recycling Information

North America : Canada

As the concern for the volume of electronic waste grows, a number of Provinces in Canada have passed regulations since 2006 to divert electronics waste from the landfills and to protect the environment. These waste diversion regulations require manufacturers of covered electronic devices to participate in approved electronic product stewardship programs. The programs allow consumers and businesses to drop off eligible electronic devices for recycling, free of charge at numerous depots throughout the Province.

For more detailed information about the recycling of the device or batteries, contact your local city office, the household waste disposal service, or the retail store where you purchased this device. These collection points are accessible free of charge.

North America : United States

For more detailed information about the recycling of the device or batteries, contact your local city office, the household waste disposal service, or the retail store where you purchased this device. These collection points are accessible free of charge.

European markets – WEEE Directive

The **W**aste **E**lectrical and **E**lectronic **E**quipment Directive (WEEE Directive) is the European directive on waste electrical and electronic equipment (Directive 2002/96/EC) which, together with the RoHS Directive 2002/95/EC, became European Law in February 2003. The WEEE Directive set collection, recycling and recovery targets for all types of electrical products. And later the WEEE Recast Directive 2012/19/EU requiring producers of electronic equipment to manage and finance the collection, reuse, recycling and appropriately treat WEEE that the producer places on the EU market after 13th August 2005.

As required by the legislation, products sold in the EU are marked with the "crossed out wheelee bin" symbol. GSI Electronics uses the symbol based on the EN 50419:2005 CENELEC standard. The bottom bar certifies the product concerned was placed on the market after 13th August 2005. Cables or components and sub-assemblies contained within the in the product will not be marked.



Instructions for disposal of waste equipment by users

The "crossed out wheelee bin" symbol on the device (and any included batteries) indicates that they should not be disposed of as normal household garbage. Do not dispose of your device or batteries as unsorted municipal waste. The device (and any batteries) should be handed over to a certified collection point for recycling or proper disposal at the end of their life.

For more detailed information about the recycling of the device or batteries, contact your local city office, the household waste disposal service, or the retail store where you purchased this device. These

Appendix L: Disposal and Recycling Information

collection points are accessible free of charge. All products with this sign must be brought to these collection points.

The disposal of this device is subject to the Waste from Electrical and Electronic Equipment (WEEE) directive of the European Union. The reason for separating WEEE and batteries from other waste is to minimize the potential environmental impacts on human health of any hazardous substances that may be present.

There are two ways available to dispose of waste:

- Public system— contact your municipality or the nearest collection site to dispose of Electrical and electronic Equipment waste
- Private system— For a Return Material Authorization for Disposal of Waste Equipment, contact customer support at 1-877-926-2777 or by e-mail at mtl_techsupport@agcocorp.com.

M Product material composition

KP-8IN-1REL

Material	Weight		Weight ratio (%)
	Lbs	Grams	
Packaging material	0,50	226,80	20,83
Plastic material	1,25	566,99	52,08
Electronic Circuits	0,55	249,48	22,93
Cable	0,05	22,68	2,08
Metal	0,05	22,68	2,08

TP-8IN-1REL

Material	Weight		Weight ratio (%)
	Lbs	Grams	
Packaging material	0,50	226,80	20,83
Plastic material	1,25	566,99	52,08
Electronic Circuits	0,55	249,48	22,93
Cable	0,05	22,68	2,08
Metal	0,05	22,68	2,08

TR-2IN-1REL

Material	Weight		Weight ratio (%)
	Lbs	Grams	
Packaging material	0,50	226,80	21,74
Plastic material	1,25	566,99	54,35
Electronic Circuits	0,45	204,12	19,57
Cable	0,05	22,68	2,17
Metal	0,05	22,68	2,17

NOTES

N Packaging characteristics

The following directives were followed during the packaging process

2011/65/EU	The RoHS 2 directive
2012/19/EU	The WEEE 2 directive
1907/2006/EU	The REACH regulation
2006/66/EC	The battery directive
94/62/EC	Packaging and packaging waste directive
97/129/EC	Packaging material identification directive

Packaging is only in cardboard to respect international standards about environment standards:

EN 13428	Packaging - Requirements specific to manufacturing and composition - Prevention by source reduction
EN 13429	Packaging - Reuse
EN 13430	Packaging - Requirements for packaging recoverable by material recycling
EN 13431	13431 Packaging - Requirements for packaging recoverable in the form of energy recovery, including specification of minimum inferior calorific value
EN 13432	Packaging - Requirements for packaging recoverable through composting and biodegradation - Test scheme and evaluation criteria for the final acceptance of packaging

Packaging was tested under ISTA 3A (Packaged Products for Parcel Delivery System Shipment weighing 150 lbs or less – is a test used for simulating courier companies shipping environments).

Shipping, packaging and Lithium battery: packaging shall be capable of withstanding a 1.2 m drop test in any orientation without damage to cells or batteries contained therein according to the International Civil Aviation Organization (ICAO), the International Air Transport Association (IATA), the International Maritime Organization (IMO) requirements.

Handling symbols on packaging: the standard is ISO R/780 (Packaging - Pictorial marking for handling of goods).

NOTES

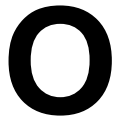

Low voltage cable specifications

Communication bus

The suggested cable is AlphaWire 45374 or with very similar specifications.

Table O-1 communication bus — communication cables

Item	Description
Cable type	Twisted and shielded
Minimum gauge	1 mm ² (18 AWG)
Maximum cable length (including cable extensions)	1200 meters (4000 feet)
Certification and type	CSA, CMG FT4 type, 18 AWG, 600 V, 75 °C (167 °F)
	UL, AWM or CM ttype, 18 AWG, 600 V, 75 °C (167 °F)
Characteristic Impedance	120 Ω +/- 12
Inductance	0.258 μH/ft, Nominal
Mutual Capacitance	12 pf/ft @1 kHz, Nominal
Velocity of propagation	75%
Conductor DCR	6.9 Ω/1000ft @20°C, Nominal
OA Shield DCR	1.8 Ω/1000ft @20°C, Nominal
Attenuation (Max dB/100ft)	0.13 @ 125 kHz
	0.25 @ 500 kHz
	0.36 @ 1 MHz
Number of Twists	2.4 Twists/foot (min)

Table O-2 DC Power cables

Item	Description				
Wire gauge	18 AWG	16* AWG	14 AWG	12 AWG	10 AWG
	1 pair twisted shielded	1 pair twisted shielded	1 pair twisted shielded	1 pair twisted shielded	1 pair twisted shielded
Max. length	150m (500 feet)	300m (1000 feet)	600m (2000 feet)	900m (3000 feet)	1200m (4000 feet)
Inductance Nominal	0.17 μH/ft	0.174 μH/ft	0.16 μH/ft	0.16 μH/ft	0.14 μH/ft
ConductorDCR @20°C, Nominal	6.1 Ω/1000ft	3.6 Ω/1000ft	2.6 Ω/1000ft	1.63 Ω/1000ft	1.09 Ω/1000ft
Certification and type	CSA, TEW type, 600 V, 105 °C (221 °F)				
	UL, 1015 type, 600 V, 105 °C (221 °F)				

*The recommended cable is AlphaWire 6451- 2 pairs:

Appendix O: Low voltage cable specifications

- 1 pair 18AWG twisted shielded for Communication;
- 1 pair 15AWG twisted shielded for Power

Table O-3 *Other Low voltage cables*

Item	Description
Cable type	Twisted and shielded
Minimum gauge	1 mm ² (18 AWG)
Maximum sensor cable length	150 m (500 feet)

- Sensor cables
- Potentiometer cables
- All other low voltage devices

P Extending a cable

- Solder all joints. See number 2 in the following figure.
- Use heat shrink tubing
- Cut the ground wire. Do not connect it. see number 1 in the following figure

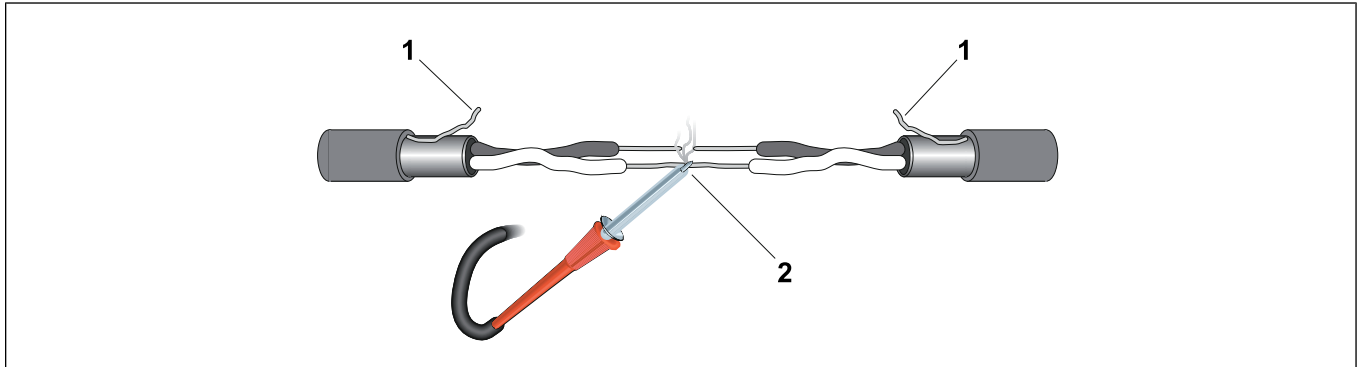

NOTES

Q KP-8IN-1REL, TP-8IN-1REL, TR-2IN-1REL - Product End-of-Life Disassembly Instructions

This disassembly and recycling guidance provides general guidance for the disassembly of the referenced product to remove components and materials requiring selective treatment, as defined by EU directive 2002/96/EC and, Waste Electrical and Electronic Equipment (WEEE).

Models and descriptions

Table Q-1 List of product for which disassembly instructions are provided

Marketing name (GSI Electronics Part number)	Description
KP-8IN-1REL, TP-8IN-1REL TR-2IN-1REL	Auxiliary modules

Table Q-2 Required tools

Tool Description	Tool size
Phillips screw driver	#1
Phillips screw driver	#2
Flat-head screw driver	Small
Flat-head screw driver	Large
Side cutters	—

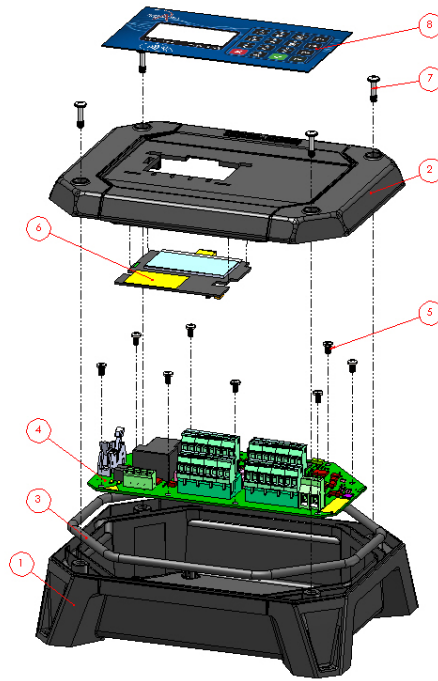

Item number	Description	Item number	Description
1	Enclosure Bottom	5	Screw SCREW,#6-19
2	Enclosure Cover	6	PCB-435
3	Gasket	7	Screw M4-0.7,16mm
4	PCB-434	8	Membrane

Items Requiring Selective Treatment

Item Description	Notes	Quantity of Items Included in the product	Location
Printed Circuit Boards (PCB) or Printed Circuit Assemblies (PCA)	With a surface greater than 10 square cm	2	PCB-434 (item 4) PCB-435 or PCB-414 (item 6)
Batteries	All types including standard alkaline and lithium coin or button style batteries.	none	
Mercury containing components	For example, mercury in lamps, display backlights, scanner lamps, lamps, lightning application, switches, and batteries.	none	

Liquid Crystal Displays (LCD)	With a surface greater than 100 square cm and all those back-lighted with gas discharge lamps.	1	OLED on PCB-435 or PCB-414 (item 6)
Cathode Ray Tubes (CRT)		none	
Capacitors / condensers	Containing polychlorinated biphenyls PCB / polychlorinated terphenyls PCT.	none	
Electrolytic Capacitors / Condensers	Measuring greater than 2.5cm in diameter or height.	none	
External electrical cables and cords		none ¹	
Gas Discharge Lamps		none	
Plastics containing Brominated Flame Retardants		none ²	
Components and parts containing toner and ink, including liquids, semi-liquids (gel/paste) and toner		none	
Components and waste containing asbestos		none	
Components, parts and materials containing refractory ceramic fibres		none	
Components, parts and materials containing radioactive substances		none	
Components, parts and materials containing chlorofluorocarbons (CFC), hydrochlorofluorocarbons (HCFC), hydrofluorocarbons (HFC), hydrocarbons (HC)		none	

12

1. GSI Electronics does not provide the external electrical cable
2. All plastics used in this product are RoHS compliant and do not contain PBBs or PBDEs

Product disassembly process

Step	Process
Remove External Electrical cables and internal Electrical cables	<ol style="list-style-type: none"> 1. Unscrew and remove the enclosure cover (item 2) 2. Remove the wires from the enclosure bottom (item 1), by unscrewing terminal blocks with a small flat-head screwdriver and a large flat-head screwdriver. 3. Remove the cable between the PCB-434 (item 4) and the PCB-435 or PCB-414 (item 6)
Printed Circuit Assembly	<ol style="list-style-type: none"> 1. Unscrew and remove the enclosure cover (item 2) 2. Locate these PCBs: PCB-434 (item 4) PCB-435 or PCB-414 (item 6) 3. Unscrew with a Philips screwdriver #1 and remove the screws (item 5) from the PCB-434 (item 4) 4. Unfasten the PCB-435 or PCB-414 from the enclosure cover 5. Remove the PCBs from the KP-8IN-1REL, TP-8IN-1REL, TR-2IN-1REL
Remove the OLED	<p>Cables are unplugged</p> <ol style="list-style-type: none"> 1. Unscrew and remove the enclosure cover (item 2) 2. Unfasten the PCB-435 or PCB-414 from the enclosure cover
Recycle plastic	<ol style="list-style-type: none"> 1. Unscrew and remove the enclosure cover (item 2) 2. From the enclosure bottom, remove the gasket(item 3) 3. Keep only plastic parts 4. Recycle the plastic enclosure and the plastic parts.

GSI Group, LLC Limited Warranty

The GSI Group, LLC (“GSI”) warrants products which it manufactures to be free of defects in materials and workmanship under normal usage and conditions for a period of 12 months after sale to the original end-user or if a foreign sale, 14 months from arrival at port of discharge, whichever is earlier. The end-user’s sole remedy (and GSI’s only obligation) is to repair or replace, at GSI’s option and expense, products that in GSI’s judgment, contain a material defect in materials or workmanship. Expenses incurred by or on behalf of the end-user without prior written authorization from the GSI Warranty Group shall be the sole responsibility of the end-user.

Warranty Extensions: The Limited Warranty period is extended for the following products:

	Product	Warranty Period
AP Fans and Flooring	Performer Series Direct Drive Fan Motor	3 Years
	All Fiberglass Housings	Lifetime
	All Fiberglass Propellers	Lifetime
AP/Cumberland	Flex-Flo/Pan Feeding System Motors	2 Years
Cumberland Feeding/Watering Systems	Feeder System Pan Assemblies	5 Years **
	Feed Tubes (1-3/4" and 2.00")	10 Years *
	Centerless Augers	10 Years *
	Watering Nipples	10 Years *
Grain Systems	Grain Bin Structural Design	5 Years
Grain Systems Farm Fans Zimmerman	Portable and Tower Dryers	2 Years
	Portable and Tower Dryer Frames and Internal Infrastructure †	5 Years

* Warranty prorated from list price:
 0 to 3 years - no cost to end-user
 3 to 5 years - end-user pays 25%
 5 to 7 years - end-user pays 50%
 7 to 10 years - end-user pays 75%

** Warranty prorated from list price:
 0 to 3 years - no cost to end-user
 3 to 5 years - end-user pays 50%

† Motors, burner components and moving parts not included.
 Portable dryer screens included.
 Tower dryer screens not included.

GSI further warrants that the portable and tower dryer frame and basket, excluding all auger and auger drive components, shall be free from defects in materials for a period of time beginning on the twelfth (12th) month from the date of purchase and continuing until the sixtieth (60th) month from the date of purchase (extended warranty period). During the extended warranty period, GSI will replace the frame or basket components that prove to be defective under normal conditions of use without charge, excluding the labor, transportation, and/or shipping costs incurred in the performance of this extended warranty.

Conditions and Limitations:

THERE ARE NO WARRANTIES THAT EXTEND BEYOND THE LIMITED WARRANTY DESCRIPTION SET FORTH ABOVE. SPECIFICALLY, GSI MAKES NO FURTHER WARRANTY OF ANY KIND, EXPRESS OR IMPLIED, INCLUDING, WITHOUT LIMITATION, WARRANTIES OF MERCHANTABILITY OR FITNESS FOR A PARTICULAR PURPOSE OR USE IN CONNECTION WITH: (I) PRODUCT MANUFACTURED OR SOLD BY GSI OR (II) ANY ADVICE, INSTRUCTION, RECOMMENDATION OR SUGGESTION PROVIDED BY AN AGENT, REPRESENTATIVE OR EMPLOYEE OF GSI REGARDING OR RELATED TO THE CONFIGURATION, INSTALLATION, LAYOUT, SUITABILITY FOR A PARTICULAR PURPOSE, OR DESIGN OF SUCH PRODUCTS.

GSI shall not be liable for any direct, indirect, incidental or consequential damages, including, without limitation, loss of anticipated profits or benefits. The sole and exclusive remedy is set forth in the Limited Warranty, which shall not exceed the amount paid for the product purchased. This warranty is not transferable and applies only to the original end-user. GSI shall have no obligation or responsibility for any representations or warranties made by or on behalf of any dealer, agent or distributor.

GSI assumes no responsibility for claims resulting from construction defects or unauthorized modifications to products which it manufactured. Modifications to products not specifically delineated in the manual accompanying the equipment at initial sale will void the Limited Warranty.

This Limited Warranty shall not extend to products or parts which have been damaged by negligent use, misuse, alteration, accident or which have been improperly/inadequately maintained. This Limited Warranty extends solely to products manufactured by GSI.

Prior to installation, the end-user has the responsibility to comply with federal, state and local codes which apply to the location and installation of products manufactured or sold by GSI.

9101239_1_CR_rev8.xml (revised January 2014)

This equipment shall be installed in accordance with the current installation codes and applicable regulations which should be carefully followed in all cases. Authorities having jurisdiction should be consulted before installations are made.

AgriAlert

1004 E. Illinois St.
Assumption, IL 62510-0020
Phone: 1-217-226-4421
Fax: 1-217-226-4420
www.gsiag.com



Agri-Alert is a part of GSI, a worldwide Brand of AGCO.