

# User Manual

# Platinum Pro / Rotem Pro



## Platinum Pro/Rotem Pro

Climate Controllers for Poultry and Pigs

Ag/MIS/UmGB-2570-04/18 Rev 1.9  
P/N: 116473



# Platinum Pro/Rotem Pro

## User Manual

Revision: N1.9 of 08/2023

Ag/MIS/UmGB-2570-04/18 Rev 1.8 (MIS)

Product Software: Version 6.24.01

This manual for use and maintenance is an integral part of the apparatus together with the attached technical documentation.

This document is destined for the user of the apparatus; it may not be reproduced in whole or in part, committed to computer memory as a file or delivered to third parties without the prior authorization of the assembler of the system.

Munters reserves the right to effect modifications to the apparatus in accordance with technical and legal developments.

<b>1</b>	<b>INTRODUCTION.....</b>	<b>11</b>
1.1	Disclaimer.....	11
1.2	Introduction .....	11
1.3	Notes .....	11
<b>2</b>	<b>INTRODUCTION TO PLATINUM PRO AND ROTEM PRO.....</b>	<b>12</b>
2.1	Front Panels.....	13
2.2	Keypad.....	13
2.3	Hot Keys .....	14
2.4	Main Screen Display .....	15
2.5	Main Menu Icons.....	17
2.6	Rotem Pro LEDs.....	17
2.7	Selecting the Mode .....	18
2.8	Software Version Screen.....	18
<b>3</b>	<b>CONTROL MENU .....</b>	<b>19</b>
3.1	Temperature Curve .....	19
3.1.1	Temperature Curve Help   Set Definitions.....	20
3.1.2	Radiant Heaters Help   Set Definitions .....	22
3.1.3	Cycle Heaters   Set Definitions.....	23
3.1.4	Variable Heater Help   Set Definitions .....	24
3.1.4.1	Linear Heat.....	24
3.1.4.2	Proportional Heat.....	25
3.1.4.3	Linear Valve .....	26
3.1.5	Temperature Humidity Index.....	27
3.1.5.1	Defining THI .....	27
3.1.5.2	THI Screens .....	28
3.2	Introduction to Humidity, Ammonia, and CO2 Treatment.....	29
3.3	Humidity Treatment.....	29
3.3.1	Humidity Treatment Main Screen.....	30
3.3.2	Humidity Treatment Help   Set Definitions.....	30
3.4	CO2 Treatment .....	31
3.4.1	CO2 Main Screen .....	31
3.4.2	CO2 Treatment Help   Set Definitions.....	32
3.5	Min/Max Level .....	33
3.5.1	By Day and By Soft Days Curve.....	33
3.5.2	By Time.....	34
3.5.3	Day Soft Min.....	34
3.5.3.1	Soft Min/Max Level Help   Set Definitions.....	34
3.5.4	By Weight.....	35

3.5.4.1	Min/Max Level By Weight Help   Set Definitions, Version 6.18 and Below .....	36
3.5.4.2	Min/Max Level By Weight Help   Set Definitions Version 6.19..	37
3.5.4.3	Weight Hot Screen .....	38
3.6	Soft Maximum Levels .....	39
3.6.1	Introduction .....	39
3.6.2	Soft Minimum Screens .....	40
3.6.3	Soft Min Max Levels .....	41
3.7	Static Pressure .....	43
3.7.1	Disabling the Static Pressure Sensor .....	44
3.7.2	Static Pressure Help   Set Definitions .....	44
3.7.3	Multi Stage Tunnel Curtains .....	45
3.8	Control Mode .....	45
3.8.1	Control Mode Main Screen .....	45
3.8.2	Catching Mode .....	46
3.9	System Parameters .....	47
3.10	Ammonia Treatment .....	47
3.10.1	Ammonia Main Screen .....	47
3.10.2	Ammonia Treatment Help   Set Definitions .....	48
3.11	Water Dosing .....	48
3.11.1	Dosing Pump Main Screen .....	49
3.11.2	Dosing Pump Settings Screen .....	49
3.11.3	Dosing Hot Screen .....	49
<b>4</b>	<b>DEVICE MENU .....</b>	<b>50</b>
4.1	Levels of Ventilation .....	51
4.1.1	Levels of Ventilation Main Screen .....	51
4.1.2	Levels of Ventilation Help   Set Definitions .....	53
4.1.3	Wind Chill .....	53
4.2	Variable Speed Fan Levels .....	54
4.3	Vent & Curtain Levels .....	55
4.3.1	Vent & Curtain Main Screen .....	55
4.3.2	Vent & Curtain Levels Help   Set Definitions .....	56
4.4	Stir Fan Levels .....	56
4.5	Stir Fan Program .....	58
4.5.1	Stir Fan Main Program .....	58
4.5.2	Stir Fan Program Help   Set Definitions .....	58
4.6	Cool Pad .....	60
4.6.1	Cool Pad (Standard) .....	60
4.6.1.1	Cool Pad Main Screen .....	60
4.6.1.2	Cool Pad Help   Set Definitions .....	61
4.6.2	Cool Pad (Ramping) .....	62

4.6.2.1	Introduction to Cool Pad Ramping.....	62
4.6.2.2	Cool Pad Main Screen .....	62
4.6.2.3	Cool Pad Help   Set Definitions .....	64
4.7	Foggers .....	65
4.7.1	Foggers Main Screen.....	65
4.7.2	Foggers Help   Set Definitions .....	65
4.8	Light .....	66
4.8.1	Configuring the Lights.....	66
4.8.2	Light Help   Set Definitions .....	67
4.8.3	Light Measurement Control.....	69
4.9	Water & Feed .....	70
4.9.1	Control via Time.....	70
4.9.2	Control via Quantity .....	71
4.9.3	Control by Feed Counter .....	71
4.9.4	Water and Feed Help   Set Definitions.....	73
4.10	Extra Systems .....	74
4.11	Water on Demand .....	74
4.11.1	Relay Control .....	75
4.11.2	Sensor Control.....	75
4.11.3	Water on Demand Help   Set Definitions.....	76
4.12	Natural Program.....	76
4.12.1	How Does Natural Ventilation Work .....	77
4.12.2	Preliminary Steps.....	77
4.12.3	Defining Natural Conditions .....	79
4.12.4	Defining Natural Operation .....	79
4.12.4.1	Defining Natural Operation / No Minimum Curtain Opening Curve .....	79
4.12.4.2	Defining Natural Operation / Minimum Curtain Opening Curve Enable .....	80
4.12.5	Natural Programming Help   Set Definitions.....	80
4.12.6	Natural Program Hot Screen.....	81
4.12.6.1	Ventilation is Not in Natural Mode.....	81
4.12.6.2	Ventilation is in Natural Mode.....	81
4.12.7	What Happens When the Controller Transitions? .....	82
4.13	Feed Scale Program .....	82
4.13.1	Feed Scale Main Screen.....	82
4.13.2	Feed Scale Help   Set Definitions .....	83
4.13.3	Operating Mode.....	84
4.13.4	Feed Scale Hot Screen .....	85
4.13.5	Feed Scale Functionality in Two Houses.....	86
<b>5</b>	<b>MANAGE MENU .....</b>	<b>89</b>

5.1	Inventory .....	89
5.2	Feed Inventory .....	90
5.2.1	Feed Inventory Help   Set Definitions.....	91
5.3	Time & Date .....	91
5.4	Growth Day & Flock/Group.....	91
5.5	Alarm Setting.....	92
5.5.1	Alarm Setting Help   Set Definitions.....	94
5.5.2	Prioritizing Alarms.....	96
5.6	Alarm Reset .....	97
5.7	Fail Safe Setting.....	98
5.8	Password.....	98
5.9	Relay Current.....	99
5.10	RDT-5 / Temperature Curve.....	100
5.10.1	RDT-5 / Temperature Curve   Set Definitions .....	101
5.10.2	RDT-5 Digital Alarm .....	101
5.10.3	Saving and Loading RDT-5 Tables .....	102
5.10.4	RDT-5, Version 6.22.....	102
<b>6</b>	<b>SCALE MENU .....</b>	<b>103</b>
6.1	Weighing Summary.....	103
6.2	Non-Gender Based Weighing .....	104
6.2.1	Scale Layout .....	104
6.2.1.1	Scale Layout Main Screen .....	104
6.2.1.2	Scale Layout   Set Definitions .....	105
6.2.2	Bird Scale Setting .....	105
6.2.2.1	Bird Scale Setting Screen.....	105
6.2.2.2	Bird Scale Setting   Set Definitions .....	106
6.2.3	Bird Weight.....	106
6.2.3.1	Bird Weight Main Screen .....	106
6.2.3.2	Bird Weight Help   Set Definitions .....	107
6.3	Gender Based Weighing .....	107
6.3.1	Auto or Auto Turkey Curve .....	108
6.3.2	Customized/Industrial Standard Curves.....	108
6.4	Silo Setting.....	109
6.5	History .....	110
6.6	Feed Conversion .....	110
6.7	Test.....	110
6.8	Calibration.....	111
6.8.1	Scale Calibration .....	111
6.8.2	Silo Calibration .....	111
6.9	Silo / Auger Layout .....	112
<b>7</b>	<b>HISTORY MENU .....</b>	<b>113</b>

7.1	Temperature .....	113
7.2	Humidity.....	113
7.3	CO2.....	113
7.4	Water.....	114
7.5	Feed.....	114
7.6	Mortality.....	115
7.7	Heaters .....	115
7.8	Radiant Heaters .....	115
7.9	Variable Heaters .....	115
7.10	Alarms .....	115
7.11	Table of Events .....	115
7.12	History View .....	116
7.13	Power Consumption.....	116
7.14	Ammonia History.....	116
7.15	Dosing History .....	116
7.16	Cool Pad.....	116
<b>8</b>	<b>TEST MENU.....</b>	<b>117</b>
8.1	Switches & Relays.....	117
8.2	Alarm.....	118
8.3	Analog Sensors.....	118
8.4	Digital Sensors.....	119
8.5	Analog Output.....	119
8.6	Static Pressure .....	119
8.7	Communication .....	120
8.8	Hardware Checklist .....	120
<b>9</b>	<b>SERVICE MENU.....</b>	<b>121</b>
9.1	Temperature Calibration.....	122
9.2	Humidity Calibration .....	122
9.3	CO2 Calibration .....	123
9.4	Static Pressure Calibration .....	123
9.5	Light Sensor Calibration .....	125
9.6	Feed Calibration .....	125
9.7	Water Calibration .....	126
9.8	Ventilation Potentiometer Calibration.....	126
9.9	Nipple Flushing.....	126
9.9.1	Nipple Flushing (Standard).....	127
9.9.2	Nipple Flushing Help   Set Definitions.....	127
9.9.3	Nipple Flushing by Temperature .....	127
9.10	Feeders & Drinkers.....	128
9.10.1	Feeders & Drinkers Main Screen.....	129

9.10.2	Feeders & Drinkers Help   Set Definitions .....	129
9.11	Save Settings .....	130
9.11.1	Saving to a Data Plug.....	130
9.11.2	Saving to an SD card .....	130
9.12	Load Settings.....	131
9.12.1	Loading from a Data Plug.....	131
9.12.2	Loading from an SD card .....	132
9.12.3	Load Settings Report .....	132
9.13	Current Sense Relay Calibration .....	133
9.14	Wind Direction Calibration .....	134
9.15	WOD Calibration .....	134
9.15.1	WOD Main Screen .....	134
9.15.2	WOD Calibration Help   Set Definitions .....	135
9.16	Ammonia Calibration .....	135
9.17	Curtains Calibration .....	136
<b>10</b>	<b>INSTALL MENU.....</b>	<b>138</b>
10.1	Setup .....	138
10.1.1	Setup Main Screen .....	138
10.1.2	Static Pressure Unit Definition.....	139
10.2	Relay Layout .....	139
10.2.1	Output Function List .....	140
10.2.2	Relay Layout – Help   Set Definitions .....	141
10.3	Analog Sensors.....	141
10.4	Digital Sensors.....	142
10.5	Analog Output.....	143
10.5.1	Light Dimmer, Variable Speed Fan, Variable Heater, Variable Stir Fan Control .....	144
10.5.2	Vent, Tunnel, and Curtain Analog Output Control .....	144
10.6	Light Dimmers .....	144
10.7	Vent / Curtain Setup .....	146
10.7.1	Using Time Control .....	146
10.7.2	Using Potentiometer Control.....	147
10.7.3	Using Wind Direction .....	148
10.7.4	Stop Fans.....	148
10.8	Temperature Definition.....	148
10.9	Fan Air Capacity .....	149
10.10	House Dimensions.....	150
10.11	Communication .....	150
<b>11</b>	<b>APPENDIX A: OUTPUT DATA.....</b>	<b>151</b>
<b>12</b>	<b>APPENDIX B: LAYERS MODE.....</b>	<b>154</b>



12.1	Layers Main Screen.....	154
12.2	Layers Vent and Curtain Levels.....	155
12.2.1	Layer Inlet Control .....	155
12.2.1.1	Pressure Control.....	156
12.2.1.2	Position Control.....	156
12.2.2	Layer Vent & Curtain (Inlet) Levels Help   Set Definitions .....	157
12.3	Egg Counter.....	158
<b>13</b>	<b>APPENDIX C: BREEDER MODE .....</b>	<b>159</b>
13.1	Egg Room Setup.....	159
13.2	Egg Counter.....	161
13.3	Egg Room Water and Feed.....	163
13.3.1	Water and Feed Version 6.23 and Below .....	163
13.3.2	Water and Feed Version 6.24 and Above .....	165
13.4	Egg Belt Runtime .....	165
13.5	Breeder Hot Keys.....	166
13.6	Nest Function.....	166
13.6.1	Single Relay .....	166
13.6.2	Dual Relay .....	167
13.7	Work Room Control.....	168
13.8	Scale Arm.....	168
13.9	Weighing the Birds in Breeder.....	169
13.9.1	Auto or Auto Turkey Curve .....	170
13.9.2	Customized/Industrial Standard Curves.....	171
13.9.3	Bird Weight History .....	171
13.10	Breeder Advanced Feeding .....	171
13.10.1	Selecting the Advanced Feeding Mode.....	174
13.10.2	Advanced Feeding Setup.....	175
13.10.3	Feed Scale Program Help   Set Definitions.....	179
13.11	Egg Room History.....	180
<b>14</b>	<b>APPENDIX D: PREVIOUS VERSION FUNCTIONS .....</b>	<b>181</b>
14.1	Scale Menu, Version 6.21 and Below .....	181
14.1.1	Setting up a Curve – Summary.....	181
14.1.2	Scale Layout.....	181
14.1.3	Bird Scale Setting .....	182
14.1.3.1	Bird Scale Setting Screen.....	182
14.1.3.2	Bird Scale Setting   Set Definitions .....	182
14.1.4	Gender Based Weighing, Version 6.21 .....	183
14.1.4.1	Enabling Gender Based Weighing .....	183
14.1.4.2	Measuring Gender-Defined Bird Weights, Auto Curve .....	183
14.1.4.3	Measuring Gender-Defined Bird Weights, Customized/Industrial Standard Curve.....	184

14.1.5	Bird Curve/Bird Weight.....	185
14.1.5.1	Bird Curve, Version 6.18 and Below .....	186
14.1.5.2	Bird Curve Help   Set Definitions.....	186
14.1.5.3	Bird Weight, Version 6.19.....	186
14.1.6	History .....	187
14.1.6.1	History, Version 6.18 and Below .....	187
14.1.6.2	History, Version 6.19.....	188
14.2	Test, Version 6.17 and Below .....	189
14.3	Vent & Curtain Levels Help   Set Definitions Version 6.18 or Below .....	189
14.4	Breeder Nest Function, Version 6.18 and Below .....	190
15	<b>WARRANTY .....</b>	<b>191</b>

# 1 Introduction

## 1.1 Disclaimer

Munters reserves the right to make alterations to specifications, quantities, dimensions etc. for production or other reasons, subsequent to publication. The information contained herein has been prepared by qualified experts within Munters. While we believe the information is accurate and complete, we make no warranty or representation for any particular purposes. The information is offered in good faith and with the understanding that any use of the units or accessories in breach of the directions and warnings in this document is at the sole discretion and risk of the user.

## 1.2 Introduction

Congratulations on your excellent choice of purchasing a Platinum Pro Controller!

In order to realize the full benefit from this product it is important that it is installed, commissioned and operated correctly. Before installation or using the controller, this manual should be studied carefully. It is also recommended that it is kept safely for future reference. The manual is intended as a reference for installation, commissioning and day-to-day operation of the Munters Controllers.

## 1.3 Notes

Date of release: May 2018

Munters cannot guarantee to inform users about the changes or to distribute new manuals to them.

All rights reserved. No part of this manual may be reproduced in any manner whatsoever without the expressed written permission of Munters. The contents of this manual are subject to change without notice.

# 2 Introduction to Platinum Pro and Rotem Pro

This document describes the Platinum Pro and Rotem Pro operations.

Computerized Electronic Controllers such as the Platinum Pro/Rotem Pro advance the producer's ability to grow high quality poultry or eggs by accurately controlling the environment. Instead of struggling with individual thermostats for heat zones and ventilation, Platinum Pro brings them all together into one convenient place with great accuracy. In Precision Mode, the Platinum Pro optimizes and precisely applies your equipment and energy sources to benefit from the accuracy of your computer and sensors.

Precision Mode is characterized by its large number of features that enable system setups that meet your exact requirements. The Platinum Pro precisely coordinates ventilation levels, providing the optimal amount of fresh air balanced with heating costs. The light and feed clocks enable efficient feed distribution. Besides advanced cooling pad methods, you benefit from superior stir fan programs to recover ceiling heat and other features. Taken together, Precision Mode's numerous features enable significant profitability improvement.

Platinum Pro/Rotem Pro provides a variety of management and history utilities. You can choose from simple overviews, or fully detailed *by the minute* records of minimum, maximum and average temperatures for each individual sensor. The unique **Table of Events** records the moment of every significant action taken by the Platinum Pro and, optionally, its operator.

- Front Panel
- Keypad
- Hot Keys
- Main Screen Display
- Main Menu Icons
- Rotem Pro LEDs
- Selecting the Mode
- Software Version Screen

## 2.1 Front Panels

The following sections detail the front panel elements.

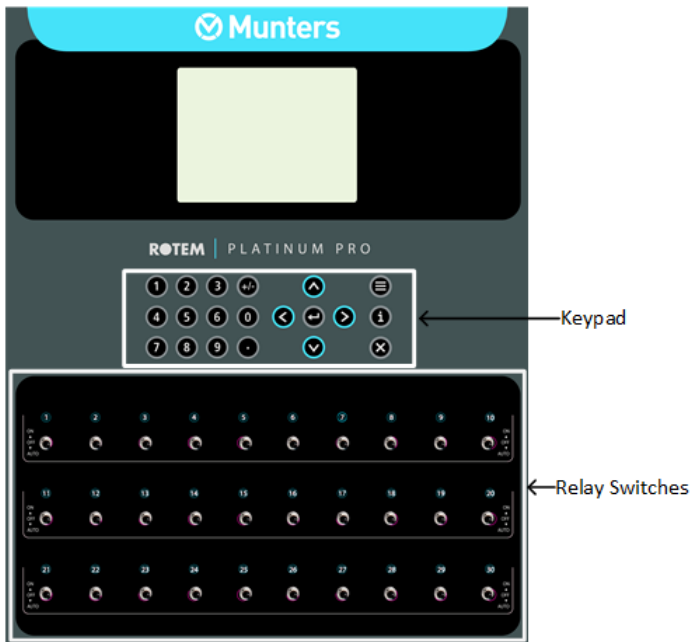

Figure 1: Platinum Pro/Rotem Pro Front Panel

## 2.2 Keypad



Enter main menu, also acts as "ESC" or "Back" key



Access help screens and graphs



Erase typing mistakes



Enter menus, values, open windows

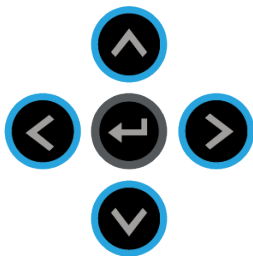

Scroll up, down, left, and right

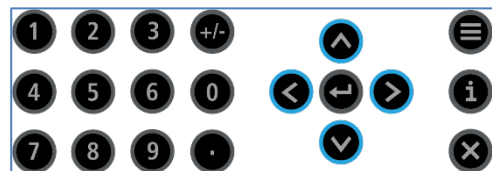

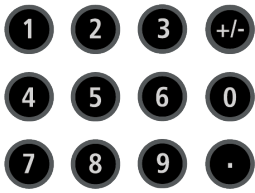

Enter values, select options and make selections

## 2.3 Hot Keys

Many of the keys serve as shortcuts to hot screens (information screens). Press these keys when the controller displays the Main Screen.



Software version



Return to standard main screen



Temperatures, inside and outside humidity status, CO2, ammonia levels, and wind chill temperature

*NOTE If two humidity or CO2 sensors are installed, Hot Screen 2 displays both readings for each sensor type. If a sensor is not installed, a dotted line appears.*



Curve status



Curtain, tunnel, vent, and attic opening positions



Bird Scale

Natural Program Status. Refer to Natural Program Hot Screen, page 81)



Light status



Analog output status



Temperature sensors



- Silo status (Poultry Mode)
- Feed Pin (Pig Mode)



Scan through Hot Screens for five seconds each



Water and Feed status



Air status (refer page 37 for details on this screen)



Zone Inlet Position: View the inlet(s) target position, actual position, and number of steps (refer to page 154 for details) (Layers)



Stir fans status



Dosing Hot Screen (Version 6.22)



Increase/ decrease offset from temperature setting from the standard display only (hold both keys) – defined in the [TEMPERATURE CURVE HELP | SET](#)



## 2.4 Main Screen Display

The main screen display depends on the operating mode.

*NOTE When in Layer Mode, refer to Layers Main Screen, page 154.*

SENSORS		AV. TEMP.	ACTIVE	
Temp1	37.9°	27.5°	Heat	1
Temp2	16.2°		Heat. Hi	1
Temp3	28.2°		Tun. Fan	
E. Tmp1	28.8°		Exh. Fan	
E. Tmp2	28.4°		Stir	
Press.	23		Cool P.	
Out T.	23.9°		Fogger	
Hum. In	58.7%		Curt. 1	100%
Hum. Out	61.9%		~Heat 1	35%
Weight	0.000		Feeder	
Weights	0		Auger	
			Valve	
			Alarm	
4 MESSAGES				
(2) Low Feed At Bin 2				

1. Sensors: Displays individual sensor readings. Temperature sensors marked with dark squares form the current average temperature.

- Filled square: Indicates the sensor participates in the average calculation.
- Empty square: Indicates the sensor does not participate in the average calculation.

SENSORS	
Temp1	37.9°
Temp2	16.2°
Temp3	28.2°
E. Tmp1	28.8°
E. Tmp2	28.4°
Press.	23
Out T.	23.9°
Hum. In	58.7%
Hum. Out	61.9%
Weight	0.000
Weights	0

NOTE Go to Table 1: Sensor Readings page 151, to view all the possible sensors.

2. Av. Temp: Reports the current average temperature. This example is in Celsius.

Av. Temp
27.5°

3. Active: Displays the output relay list. The filled black boxes indicate active outputs. The controller also informs the position of inlets and curtains, as well as the number of operating heaters or fans.

ACTIVE	
Heat	1
Heat. Hi	1
Tun. Fan	
Exh. Fan	
Stir	
Cool P.	
Fogger	
Curt. 1	100%
Curt. 2	100%
Feeder	
Auger	
Valve	

NOTE Go to Table 2: Output List (Active), page 151 to view all the available readings (ACTIVE).

NOTE The ACTIVE screen shows rectangular markers by the outputs. Filled rectangles indicate operating outputs; empty rectangles indicate outputs that are off.

4. Status: Provides important general information such as the time and ventilation mode.

EXAMPLE

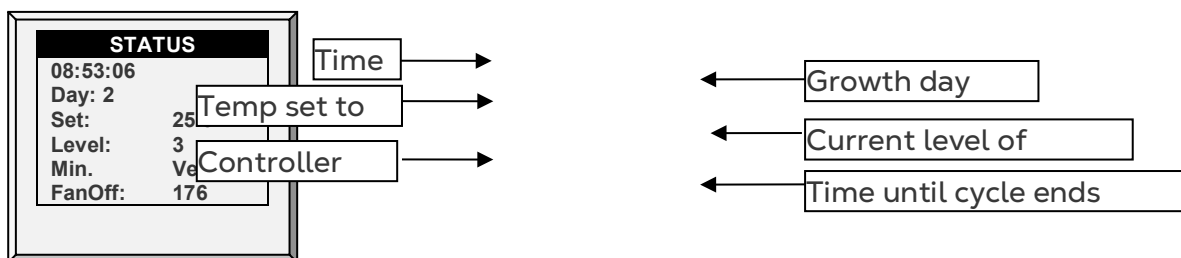

NOTE Go to Table 1: Sensor Readings, page 151 to view all the available readings.

5. Messages: Displays important messages/alarms. The title bar displays the number of important messages, and if there are several messages, they each appear in turn.



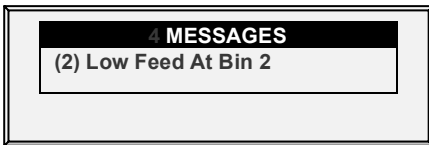

## 2.5 Main Menu Icons

- To enter the Main Menu screen, press Menu.
- To select an option, press Enter.

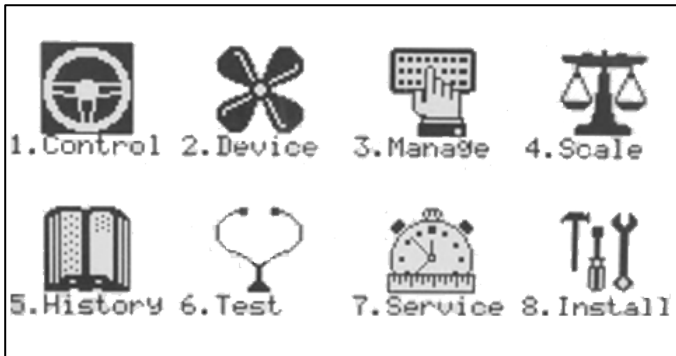

1. Control temperature, humidity, ventilation, static pressure, and system parameters.
2. Define equipment settings.
3. Manage inventory, livestock, and alarm/password settings.
4. Set, calibrate and test Bird Scale and Silo Scale.

*NOTE The Pigs mode has a limited number of functions in this menu.*

5. View history of all controller functions.
6. Test to see if switches, relays, communication, and alarms are functioning properly.
7. Calibrate temperature, humidity, ventilation, static pressure, feed, water, read/save to plug.
8. Install sensors, devices, communication, etc.

## 2.6 Rotem Pro LEDs

Rotem Pro features LEDs on each relay panel. These LEDs turn red on all relay cards when there is any active alarm (even one); they are white when there are no alarms. Refer to the main screen to view the alarms.

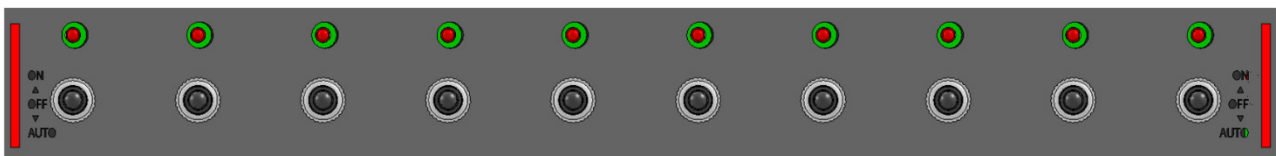

## 2.7 Selecting the Mode

Platinum Pro runs in four modes: Broiler, Layer, Breeders, and Pigs.

To select the mode:

1. Disconnect the power cable from the power source.
2. Reapply power while pressing Delete. The Cold Start screen appears.
3. Select Yes. The Choose Controller Type appears.
4. Select the required mode.
5. Press Enter.

*NOTE The manual is based on Broiler Mode. Functions that are unique to Layers and Breeders and described in separate appendixes. Except for a few functions dealing with scales, Pig Mode supports the vast majority of functions seen in Broiler Mode. Pig Mode has some different terminology (for example herd instead of flocks).*

- Appendix B: Layers Mode
- Appendix C: Breeder Mode

*NOTE Breeder Mode supports an advanced feeding program. Refer to Breeder Advanced Feeding, page 169 for details on enabling this program.*

## 2.8 Software Version Screen

To view the current mode, software version, versions of installed cards, and versions of accessories, go to the Main Screen and press Help. Version 6.19 shows the cards' versions.

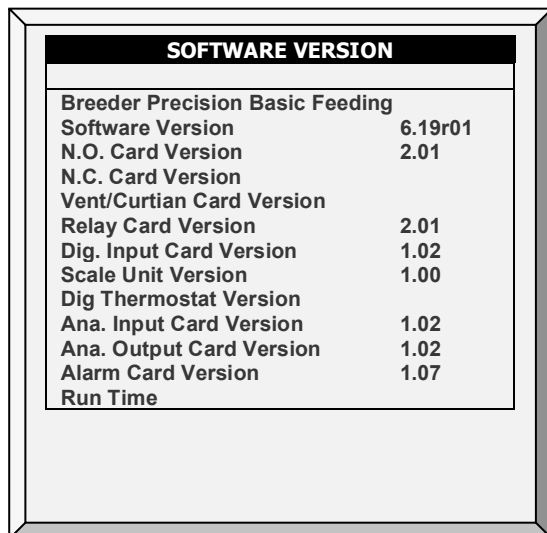

SOFTWARE VERSION	
Breeder Precision Basic Feeding	
Software Version	6.19r01
N.O. Card Version	2.01
N.C. Card Version	
Vent/Curtian Card Version	
Relay Card Version	2.01
Dig. Input Card Version	1.02
Scale Unit Version	1.00
Dig Thermostat Version	
Ana. Input Card Version	1.02
Ana. Output Card Version	1.02
Alarm Card Version	1.07
Run Time	

# 3 Control Menu

The following sections detail:

- Temperature Curve, page 19
- Introduction to Humidity, Ammonia, and CO2 Treatment, page 29
- Humidity Treatment, page 29
- CO2 Treatment, page 31
- Min/Max Level, page 33
- Static Pressure, page 39
- Control Mode, page 45
- System Parameters, page 47
- Ammonia Treatment, page 47
- Water Dosing, page 48

CONTROL	
1.	TEMPERATURE CURVE
2.	HUMIDITY TREATMENT
3.	CO2 TREATMENT
4.	MIN/MAX LEVEL
5.	STATIC PRESSURE
6.	CONTROL MODE
7.	SYSTEM PARAMETERS
8.	AMMONIA TREATMENT
9.	WATER DOSING

## 3.1 Temperature Curve

This screen sets the temperature targets according to the bird/pig age.

TEMPERATURE CURVE						
Day	Target	Heat	Tunnel	Alarm		T.Hi
				Low	High	
1	89.0	89.0	100.0	84	102	103
2	89.0	89.0	99.0	84	102	103
3	87.0	87.0	97.0	82	95	103
7	84.0	83.0	91.0	80	95	103
15	82.0	81.0	89.0	78	93	103
21	79.0	78.0	86.0	75	90	103
28	76.0	74.0	81.0	71	87	103
35	72.0	70.0	77.0	67	84	103
42	70.0	68.0	75.0	63	83	103
48	68.0	66.0	73.0	60	83	103

1. In *Install > Analog Sensors* (refer to Analog Sensors, page 141), designate the required number of sensors as temperature sensors. When using more than one sensor, the controller begins treatments based on the average.
2. If required, go to *Service > Temperature Calibration*, calibrate the sensors (refer to Temperature Calibration, page 122).
3. In *Install > Temperature Definition* (refer to Temperature Definition, page 148), assign specific sensors brood setups, heater zones, and devices. If a zone does not have an assigned sensor, calculations are based on the current average temperature.
4. In *Control > Temperature Curve*, define the required target temperature curve.
  - Set up to 20 lines, 999 growth days. When a curve is not required (for example when growing layers), enter temperatures in the first line only.
  - Define:

- **Day:** Set the growth day. You can program negative growth days up to -7 for pre-warming. To enter a negative growth day, type the day number followed by the ± key.
- **Target:** Set the desired temperature.
- **Heat:** Set the temperature to stop heat.
- **Tunnel:** Set the temperature for tunnel ventilation to begin.
- **Alarm Low & High:** Set average temperature alarm limits. See [Manage | Alarm Settings](#) for zone alarm settings.
  - Version 6.23 enables setting the temperature alarms to 0.X degrees (only when the temperature is set to Celsius).

TEMPERATURE CURVE						
Day	Target	Heat	Tunnel	Alarm		T.Hi
				Low	High	
1	31.7	31.7	37.8	28.9	38.9	39.4
2	31.7	31.7	37.2	28.9	38.9	39.4
3	30.5	30.6	36.1	27.8	35.6	39.4
7	28.9	28.3	32.8	26.7	35.6	39.4
15	27.8	27.2	31.7	25.6	33.9	39.4
21	26.1	25.6	30.0	23.9	32.2	39.4
28	24.4	23.3	27.2	21.7	30.6	39.4
35	22.2	21.1	25.0	19.4	28.9	39.4
42	21.1	20.0	23.9	17.2	28.3	39.4
48	20.0	20.0	22.8	15.6	28.3	39.4

- **T.Hi:** Set a high temperature alarm for Tunnel mode.

*NOTE Only Pig mode supports variable floor heaters. To enable this function, define an analog output as a floor heater (refer to Analog Output, page 143).*

5. If required set the:

- Temperature Curve Help | Set Definitions, page 20
- Radiant Heaters Help | Set Definitions, page 22
- Cycle Heaters | Set Definitions, page 23
- Variable Heater Help | Set Definitions, page 24
- Temperature Humidity Index, page 27

### 3.1.1 TEMPERATURE CURVE HELP | SET DEFINITIONS

② *While viewing the Temperature Curve menu: Press Help, select Set and press Enter.*

SYSTEM PARAMETERS	
<b>TEMPERATURE CURVE</b>	
Temperature Curve Offset	0.0
Set Temp. Change Reminder (Diff)	3.0
Target Temp. Band	1.5
Heater Temp. Band	1.0
Cool Down Factor (%)	15
Cool Down Fast Response (Deg.)	3.0
Min Vent Below Heat Temp By: ▶	ZONE
Non Brood Area Diff. From Heat	-3.0

- **Temperature Curve Offset:** Adjusts all temperature curves by this amount. You can use this to temporarily adjust all temperatures up or down for special

circumstances. The curve appears in the [Status Window](#), and you can use the [ENTER and Up](#) or [ENTER and Down](#) hot key combinations to change the offset.

- **Set Temp. Change Reminder (Diff):** Sets the change in set temperature that triggers a reminder for you to set backup thermostats. Often producers forget to set backup thermostats as their birds grow from baby chicks to market age, so the Controller reminds you. When you press Enter to acknowledge the reminder, the Controller logs it in the Table of Events.
- **Target Temp. Band:** The size of the target temperature zone. This "Happy Zone" is between Target Temperature and (Target Temperature + Band).
- **Heater Temp. Band:** Heaters turn on at 'Band' degrees below Heat and turn off at the Heat Temperature.

*NOTE Heaters operate at minimum level only; however, Radiant Heaters can operate at any temperature or level below Tunnel.*

- **Cool Down Factor (%):** Minimum percentage correction towards target during each increase [ventilation level delay](#). If the average temperature does not improve by this amount, the Controller increases ventilation by one level.
- **Cool Down Fast Response (Deg.):** Set a limit to the maximum degrees per minute of cooling. If Average Temperature drops more than this in one minute, the Controller decreases ventilation one level to avoid overshooting.

*NOTE Avoid making this parameter too small or the normal temperature variation caused by timer fans reduces the ventilation level.*

- **Min Vent Below Heat Temp By:** Tells controller to go directly to Min Level in some cases. Select from the following choices:
  - None: Operate by the normal level decrease time delay rule.
  - Zone: Go directly to minimum level if any active temperature sensor reaches heat temperature.
  - Avg.: Go directly to minimum level if the average temperature reaches heat temperature.
- **Non Brood Area Diff. From Heat:** Set differential temperature for non-brood heaters. You normally use this to set temperatures in unoccupied areas.

*NOTE When set at -99°F the heaters are effectively disabled, since it will probably never go to 99°F below the heater temperature. Putting this parameter at 0° sets the non-brood areas to the heater temperature.*

### 3.1.2 RADIANT HEATERS HELP | SET DEFINITIONS

SYSTEM PARAMETERS	
<b>TEMPERATURE CURVE</b>	
Temperature Curve Offset	0.0
Set Temp. Change Reminder (Diff)	3.0
Target Temp. Band	1.5
Heater Temp. Band	1.0
Cool Down Factor (%)	15
Cool Down Fast Response (Deg.)	3.0
Min Vent Below Heat Temp By: <span style="float: right;">▶</span>	ZONE
Non Brood Area Diff. From Heat	-3.0
<b>RADIANT HEATERS</b>	
Rad. Low -Diff from Heat Set	0.0
Rad. High -Diff (Below Low Set)	1.0
Radiant Ignition Time (sec)	30

To configure the radiant heaters:

1. In *Installation > Relay Layout* define at least one relay as a radiant heater (page 139).
2. Configure the following parameters:
  - **Radiant Low – Differential from Heat Set:** Set degree of difference from Heat for LOW Radiant Heaters to begin working. This differential can be positive or negative. (default: 2.0)
  - **Radiant High – Differential (Below Low Set):** Set number of degrees below Radiant Low Heaters for HIGH Radiant Heaters to begin working (default: 1.0). To ensure proper heater ignition, Radiant High Heaters remain on for the Radiant Ignition Time along with the Radiant Low Heaters.
  - **Radiant Ignition Time (sec):** Set number of seconds to power radiant ignition (default: 30).
3. **Version 6.20:** As an option, you can configure the Radiant Low – Differential from Heat Set parameter for each heater.

SYSTEM PARAMETERS	
<b>RADIANT HEATERS</b>	
Individual Rad. Low Diff Set	YES
Rad. Low -Diff from Heat Set	1.1
Rad. High -Diff (Below Low Set)	0.6
Radiant Ignition Time (sec)	30

- In the Individual Rad. Low Diff Set, define as yes. An individual parameter for each heater appears.

**NOTE** The Heater Temperature Band applies to radiant heaters as well. For example, if the Heat Temperature is 80° F and the Heater Temperature Band is 1° F, then heaters turn on at 79° F and off at 80° F. If the Radiant Low Differential is at 2.0° F, then radiant heaters turn off at 82° F, and on 1° F below that at 81° F. However, a Radiant High Heater turns on regardless of its temperature setting for the Radiant Ignition Time whenever the corresponding Radiant Low Heater turns on. This feature ensures proper flame ignition.

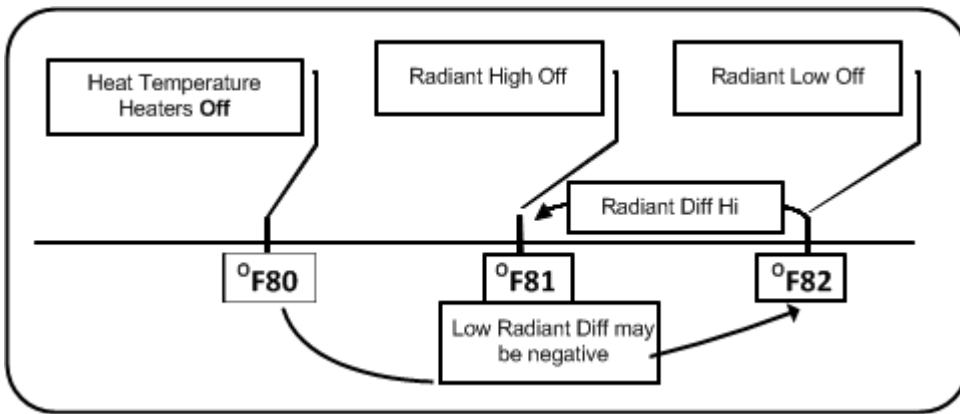

Figure 2: Radiant Heater Differentials

### 3.1.3 CYCLE HEATERS | SET DEFINITIONS

Heat Cycle means providing heat in conjunction with the ventilation system during minimum ventilation cycles, using heaters and fans connected to relays. When enabled, heaters operate during the fans' cycle off time (as defined in the Levels of Ventilation Cycle Timer On and Off parameters). How does it work?

Between the Heat Temperature and the differential temperature, heaters do not operate. When the temperature goes below the Heat Off temperature minus the Low Heat Differential:

- Heaters begin to operate when the exhaust or tunnel fans are off. Heaters operate for the Minimum On Time.
- If the temperature continues to drop, heaters operate for longer periods of time, up to the Maximum On Time (defined in Levels of Ventilation).
- Platinum Pro/Rotem Pro automatically generates a curve.

In this example:

- Temperature Curve Heat Off is 78°.
- Low Heat Differential is 1°.
- High Heat Differential is 8°.
- Minimum On time is 30 seconds.
- Cycle Off time is 270 seconds.

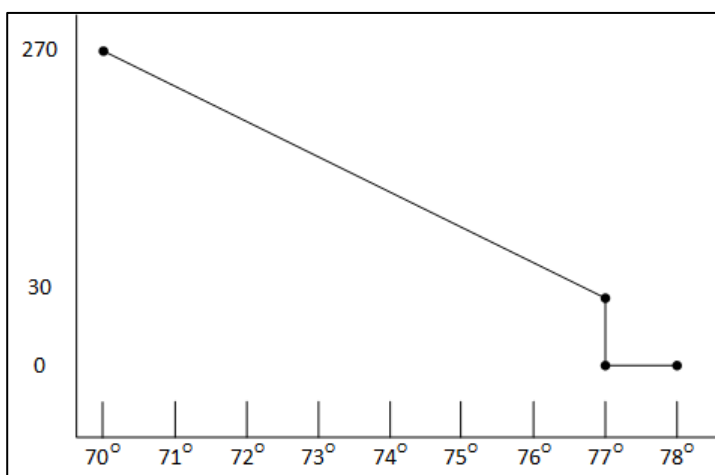

1. Define the required number of heater and exhaust and/or tunnel relays (Relay Layout, page 139).
2. In Control > Control Mode, set the Heater Cycle to Yes.
3. In Control > Temperature Curve > Help, scroll to Cycle Heater.
4. Define:
  - **Low Heat Differential:** The differential below the Heat Off temperature, at which heating begins and runs for the minimum amount of time.
  - **High Heat Differential:** The differential below the Heat Off temperature, at which heating runs for the maximum amount of time.
  - **Minimum ON Time:** Minimum heating time when the exhaust or tunnel fans are off.

### 3.1.4 VARIABLE HEATER HELP | SET DEFINITIONS

The Controller enables configuring up to eight variable heaters. The heater output changes according to the output of a 0 – 10 VDC device.

➤ Install at least one analog output card.

To configure the variable heaters:

1. In *Installation > Analog Output* configure:
  - a. up to eight analog outputs as variable heaters
  - b. the minimum and maximum voltage output for each heater

ANALOG OUTPUT			
Out No.	Output Function	Min V.Out	Max V. Out
1	Var. Heater 1	1.0	10.0
2	Var. Heater 2	1.0	10.0
3	Var. Heater 3	1.0	10.0
4	Var. Heater 4	1.0	10.0
5	Var. Heater 5	1.0	10.0
6	Var. Heater 6	1.0	10.0
7	Var. Heater 7	1.0	10.0
8	Var. Heater 8	1.0	10.0

2. In *Control > Control Mode > Analog Heat Mode*, define the mode.
  - Linear Heat:
  - Proportional Heat
  - Linear Valve
3. In *Control > Temperature Curve > Help*, define the parameters for each mode.

#### 3.1.4.1 Linear Heat

When Linear Mode is enabled:

- Between the Heat Temperature and the Target temperature, heaters do not operate (meaning, the output voltage is 0).
- Between the Heat Temperature and the Low Difference Below Heat, heaters operate at the minimum voltage output.
- If the temperature continues to drop, the voltage output increases until it reaches the maximum voltage output at the High Difference below Heat.



In this example:

- Target Temperature is 80°
- Temperature Curve Heat Off is 78°.
- Low Heat Differential is 1°.
- High Heat Differential is 8°.
- If the temperature is between 77° to 78°, the output voltage is the minimum voltage defined in Installation > Analog Output (1 volt in this example).
- If the temperature continues to drop, the output voltage increases until it reaches the maximum voltage defined in Installation > Analog Output. Output increases or decreases to keep the temperature within the Target Temperature and Heat Off band.

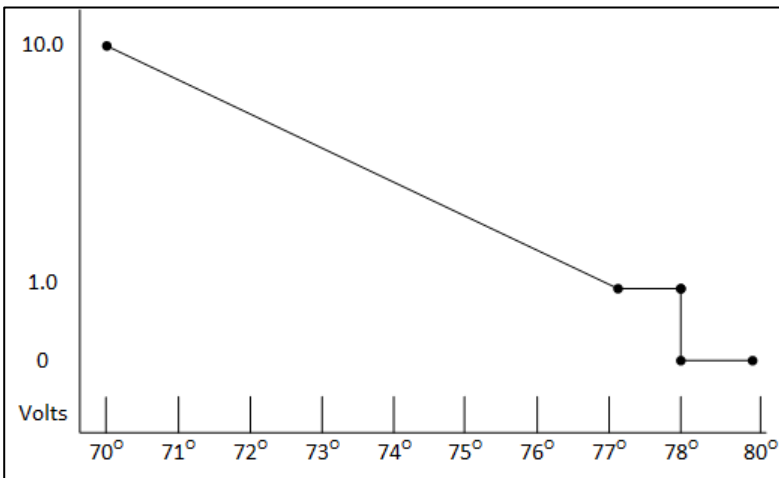

SYSTEM PARAMETERS	
<b>RADIANT HEATERS</b>	
Rad. Low -Diff from Heat Set	0.0
Rad. High -Diff (Below Low Set)	1.0
Radiant Ignition Time (sec)	30
<b>VARIABLE HEATER</b>	
Low Diff Below Heat	1.0
High Diff Below Heat	8.0

- Define the parameters:
  - **Low Difference Below Heat:** Temperature difference between the Heat Off parameter at which the variable heater begins to function.
  - **High Difference Below Heat:** Temperature at which the heater begins to operate at maximum output.

### 3.1.4.2 Proportional Heat

Proportional Heat works in manner similar to Linear Mode. The difference is that Proportional Heat features a delay time.

- When the temperature falls below the user-defined point, the heaters begin operating at their minimum output.
- After the response time passes, the controller checks the temperature. If it is still below the defined point, the controller increases the voltage by a certain amount (this amount of the increase cannot be changed).

- After the response time passes, the process is repeated until heaters operate at their maximum output.

SYSTEM PARAMETERS	
<b>RADIANT HEATERS</b>	
Rad. Low –Diff from Heat Set	0.0
Rad. High –Diff (Below Low Set)	1.0
Radiant Ignition Time (sec)	30
<b>VARIABLE HEATER</b>	
Diff Above Heat to Stop Heater	1.0
High Diff Below Heat	8.0
Response Time (seconds)	15

- Define the parameters.
  - **Difference Above Heat to Stop Heater:** Differential from target temperature at which the heater runs at minimal input.
  - **High Difference Below Heat:** High Difference Below Heat: Temperature at which the heater begins to operate at maximum output.
  - **Response Time (seconds):** Amount of time before the controller begins to change the ventilation.

### 3.1.4.3 Linear Valve

SYSTEM PARAMETERS	
<b>RADIANT HEATERS</b>	
Rad. Low –Diff from Heat Set	0.0
Rad. High –Diff (Below Low Set)	1.0
Radiant Ignition Time (sec)	30
<b>VARIABLE HEATER</b>	
Low Diff Below Heat	1.0
High Diff Below Heat	8.0

Linear Valve enables defining that variable heater input voltage is always equal to or above the minimum input defined in Installation > Analog Sensors.

When the Analog Heat Mode is defined as having Linear Valve control, there is always a minimal voltage input. Therefore, if the minimum voltage is 1 volt:

- The voltage range is from 1 to 10 volts.
  - this corresponds to 10% at 1V and 100% at 10V.
  - interpolation inside the band
- There is 0% voltage when the target temperature is reached.

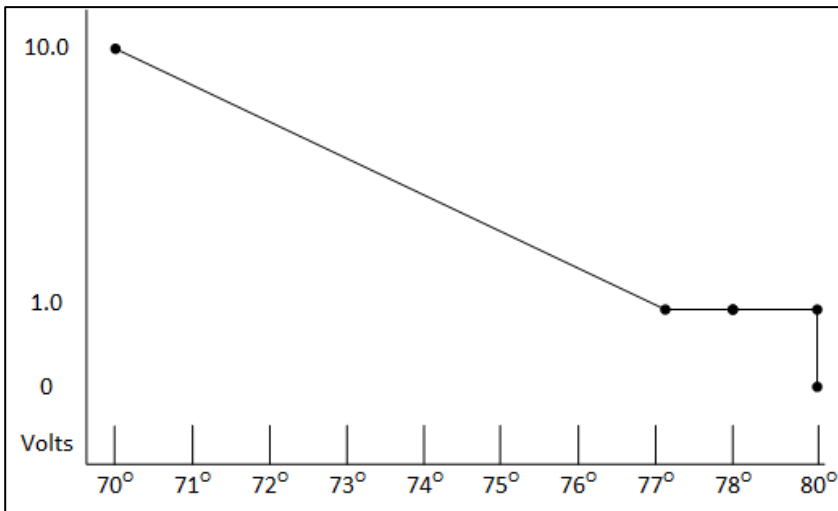

- Define.
  - **Difference Above Heat to Stop Heater:** Differential from target temperature at which the heater runs at minimal input.
  - **High Difference Below Heat:** High Difference Below Heat: Temperature at which the heater begins to operate at maximum output.

### 3.1.5 TEMPERATURE HUMIDITY INDEX

As an option, Platinum Pro/Rotem Pro Version 6.20 can operate the ventilation according to a temperature-humidity index (THI), a formula that combines the temperature and humidity levels. This formula measures heat stress and is an industry standard that can be used to provide ventilation efficiently. Based on this formula, Platinum Pro/Rotem Pro recalculates the target and heat temperatures defined in the Temperature Curve screen. Ventilation is then based on the calculated values. Please note:

- The calculated target temperature can be higher or lower than the standard target temperature.
- When this option is used, the Humidity Treatment screen is disabled.
- THI does not affect the Tunnel Temperature.
- THI does not affect CO2 or Ammonia treatments.
- THI temperatures only operate when the controller provides minimum ventilation or is operating in Natural Mode (meaning, not in Tunnel Mode).

#### 3.1.5.1 Defining THI

➡ THI requires installing and defining a humidity sensor.

To enable THI ventilation:

1. In Control > Control Mode, enable THI Mode.

CONTROL MODE	
House Mode	FULL HOUSE
Empty House Mode	NO
Temperature Curve	YES
Min. Max. Level Control	BY WEIGHT
Heat Cycle:	NO
Analog Heat Mode	LINEAR
THI Mode	YES

2. Go to Control > Temperature Curve > Set Definitions.

SYSTEM PARAMETERS THI MODE	
RH Set Point (%)	65
Target Temp Offset per 1% RH	0.07
Max Target Temp Offset (°)	5.40

3. Define:

- RH Set Point (%): Define the relative humidity at which THI begins recalculating the target and heat temperatures. Range: 55 – 75%.
- Target Temperature Offset per 1% Relative Humidity: Define the change in the target temperatures as relative humidity increases. This quantity is entered into a controller algorithm. Range: 0.0 – 0.4° C/0.0 – 0.9° F

*NOTE If the relative humidity rises above the set point, the target temperature drops. If the relative humidity drops below the set point, the target temperature rises. In each case, the ventilation changes accordingly.*

- Maximum Target Temperature Offset (°): Define the maximum possible offset. Range: 0.10 – 10.0° C/0.18 – 18.0° F.
- Version 6.23: Max Offset Above/Below Targ Temp(°): Define the maximum possible offset above and below the target temperature. Range: 0.10 – 10.0° C/0.18 – 18.0° F.

SYSTEM PARAMETERS THI MODE	
RH Set Point (%)	65
Target Temp Offset per 1% RH	0.07
Max Offset Above Targ Temp(°):	5.40
Max Offset Below Targ Temp(°):	5.40

### 3.1.5.2 THI Screens

- The Main Screen will display the THI target temperature.

STATUS	
08:53:06	
Day: 2	
THI:	30.0
Level:	3
Min. Vent	
FanOff:	176

- Hot Screen #3 displays the THI temperatures along with the standard temperatures.

CURVE STATUS		Current	
THI	Target Temp	30.0°	30.0°
THI	Heat Off T.	28.0°	28.0°
	Tunnel Temp	32.2°	
THI	Low Alarm T.	23.9°	23.9°
	High Alarm Temp	35.0°	
	Tunnel High Alarm	35.0°	
	Target Stat. Press.	0.080	
	Minimum Level	1	
	Maximum Level	30	

### 3.2 Introduction to Humidity, Ammonia, and CO2 Treatment

Platinum Pro/Rotem Pro provides various options to controlling the humidity, CO2, and ammonia levels.

- **None:** No treatment is provided.
- **Level:** Ventilation levels increase for a designated amount of time.
- **Tunnel or exhaust fan:** A designated fan turns on for a designated amount of time. The amount of air blown into the house is greater than that provided by an increase in ventilation level.
- **Increase in air / weight:** The total amount of air that fans need to provide increases by a user defined amount. Fans stay on until CO2, humidity, or ammonia levels fall to their defined levels. This option is only available when using Minimum Ventilation by Weight.
- **Humidity treatment by heat:** In cold air situations, heaters can be turned on to lower the relative humidity.

If there is a contradiction between CO2, humidity, and ammonia treatments:

- Ammonia treatment has priority over CO2 treatment.
- CO2 treatment has priority over humidity treatment.
- Increase in air / weight has priority over other treatments.
- Humidity treatment by heat takes priority over increasing the ventilation.

### 3.3 Humidity Treatment

- Humidity Treatment Main Screen
- Humidity Treatment Help | Set Definitions

### 3.3.1 HUMIDITY TREATMENT MAIN SCREEN

Humidity treatment forces an increase in ventilation level when the humidity is too high. It holds the increase for 'Duration Seconds' and checks back after 'Interval Minutes' for another increase. After the duration, the ventilation level comes back down automatically.

HUMIDITY TREATMENT			
Day	Humidity	Delay (Min)	Duration (sec.)
1	70	10	130
7	75	7	150
14	80	5	180
0	0	0	0
0	0	0	0
0	0	0	0
0	0	0	0
0	0	0	0

1. In *Install > Analog Sensors* (refer to Analog Sensors, page 141), designate up one or two sensors as indoor humidity sensors (outdoor sensor is for information only). When using more than one sensor, the controller begins treatments based on the average.
2. If required, go to *Service > Humidity Calibration*, and calibrate the sensors (refer to Humidity Calibration, page 122).
3. In *Control > Humidity Treatment* set the parameters as required.
  - Day: Growth day. Can set multiple programs for same day (Maximum number of programs: 20)
  - Humidity: Humidity at which to begin treatment
  - Delay Minute: Amount of time the controller pauses before ventilating.
  - Duration Seconds: Number of seconds the controller maintains the increased level of ventilation.

### 3.3.2 HUMIDITY TREATMENT HELP | SET DEFINITIONS

- ② While viewing the Humidity Treatment menu: Press **HELP**, select **SET**, and press **ENTER**.

HUMIDITY TREATMENT	
Humidity Band (%)	5.0
Humidity Treatment below Heat	YES
Humidity Treatment By	Exh 6
HUMIDITY TREATMENT BY HEATERS	
Humidity Treatment by Heaters	YES
Outside Temp Treat by Heaters	-18.0
Diff to Stop Treatment by Heaters	3.6

- Define:
  - Humidity Band (%): Hysteresis band (delay) for Humidity Treatment.
  - Humidity Treatment below Heat: Select YES or NO for allowing Humidity Treatment when heaters are operating (set in Temperature Curve).
  - Humidity Treatment By: This parameter designates the method used when humidity or CO2 treatment begins. Normally, this parameter is relevant only when minimum ventilation is running. When a treatment is required, select one the method to be employed:
    - Level: Increases the ventilation level when a treatment is required.

*NOTE When employing Ventilation by Weight, the controller increases the cycle time or the level, depending on the particular settings.*

- Exhaust: Designate a specific exhaust fan (press a number key to select the fan).
- Tunnel: Designate a specific tunnel (press a number key to select the fan).
- None: Disables the treatment.

➤ To enable the exhaust/tunnel options, in Installation > Relay Outlet or Installation > Analog Output, designate at least one relay/variable device as a tunnel or exhaust fan.

- Humidity Treatment by Heaters: This parameter enables using the heaters to lower the relative humidity. If enabled, define:
  - Outside Temp Treat by Heaters: Heaters handle humidity treatment when the outside temperature is lower than the target temperature by this amount.
  - Diff to Stop Treatment by Heaters: Heaters cease the humidity treatment if the inside temperature is lower (or higher) than the target temperature by this amount. This number can be positive or negative.

➤ Humidity Treatment by Heaters requires designating at least one temperature sensor as an outside sensor (refer to Temperature Definition, page 148).

*NOTE If the heaters are operating because of the interior temperature, Humidity Treatment by Heaters is disabled.*

*NOTE Broiler and Breeder Modes support Humidity Treatment by Heaters.*

## 3.4 CO2 Treatment

- CO2 Main Screen
- CO2 Treatment Help | Set Definitions

### 3.4.1 CO2 MAIN SCREEN

CO2 treatment forces an increase in ventilation level when the CO2 level is too high. It holds the increase for 'Delay Seconds' and checks back after 'Interval Minutes' for another increase. After the duration, the ventilation level may come back down automatically. If during treatment, the CO2 level drops below the **Stop Value** parameter, the ventilation level automatically returns to that level used before CO2 treatment was initiated.

- Version 6.19 and below support one CO2 sensor.
- Version 6.20 supports two CO2 sensors. If two sensors are installed, the Main Screen displays the average.

CO2 TREATMENT				
Day	Start Value	Stop Value	Delay (Sec)	Duration Sec.
1	3000	2500	120	130
7	2700	2200	120	150
14	2500	2000	90	180
0	0	0	0	0
0	0	0	0	0
0	0	0	0	0
0	0	0	0	0
0	0	0	0	0
0	0	0	0	0
0	0	0	0	0

1. In *Install > Analog Sensors* (refer to Analog Sensors, page 141), designate one sensor as a CO2 sensor.
2. If required, go to *Service > CO2 Calibration*, calibrate the sensors (refer to CO2 , page 123).
3. In *Control > CO2 Treatment* set the parameters as required.
  - Day: Growth day. You can set multiple programs for same day (maximum number of programs: 20)
  - Start Value: CO2 value at which to begin treatment.
  - Stop Value: CO2 value at which to end treatment.
  - Delay (Sec): Number of seconds the controller pauses before ventilating.
  - Duration (Sec): Number of seconds the controller maintains the increased level of ventilation.

### 3.4.2 CO2 TREATMENT HELP | SET DEFINITIONS

- ② While viewing the CO2 Treatment menu: Press **HELP**, select **SET** and press **ENTER**.

SYSTEM PARAMETERS	
CO2 TREATMENT	
CO2 Treatment Below Heat	NO
CO2 Treatment By	Exh 6
CO2 TREATMENT BY HEATERS	
CO2 Treatment by Heaters	YES
Outside Temp Treat by Heaters	-18.0
Diff to Stop Treatment by Heaters	3.6

- CO2 Treatment below Heat: Select YES or NO to enable CO2 treatment when heaters are operating (set in Temperature Curve).
  - CO2 Treatment By: This parameter designates the method used when humidity or CO2 treatment begins. Normally, this parameter is relevant only when minimum ventilation is running. When a treatment is required, select one the method to be employed:
    - Level: Increases the ventilation level when a treatment is required.
- NOTE** When employing Ventilation by Weight (refer to page 35), the controller increases the cycle time or the level, depending on the particular settings.
- Exhaust: Designate a specific exhaust fan (press a number key to select the fan).
  - Tunnel: Designate a specific tunnel (press a number key to select the fan).



- None: Disables the treatment.
- To enable the exhaust/tunnel options, in *Installation > Relay Outlet*, designate relays as Tunnel or Exhaust Fans.
  - CO2 Treatment by Heaters: This parameter enables running the heaters in situations where the CO2 level is high. Typically this can happen in cold temperatures when CO2 is produced by the heaters. By increasing the heat in the house, ventilation can then be increased. If enabled, define:
    - Outside Temp Treat by Heaters: Heaters handle CO2 treatment when the outside temperature is lower than the target temperature by this amount.
    - Diff to Stop Treatment by Heaters: Heaters cease the CO2 treatment if the inside temperature is lower (or higher) than the target temperature by this amount. This number can be positive or negative.
- CO2 Treatment by Heater requires designating at least one temperature sensor as an outside sensor (refer to Temperature Definition, page 148).

*NOTE If the heaters are operating because of the interior temperature only, CO2 Treatment by Heater is disabled.*

### 3.5 Min/Max Level

- **IMPORTANT:** Before setting Min/Max level, go through and set up the Device Settings, especially the [ventilation levels](#).

Once you have entered the ventilation levels, use the Min/Max to select the range of levels to apply to your situation. Typically, Platinum Pro/Rotem Pro increases the minimum ventilation level as litter conditions deteriorate and the birds require greater amounts of fresh air. You can also restrict the maximum level to prevent excess airflow on young birds.

- Go to *Control > Control Mode* to select the minimum ventilation method:
  - By Day and By Soft Days Curve
  - By Time
  - Day Soft Min.
  - By Weight

#### 3.5.1 BY DAY AND BY SOFT DAYS CURVE

MIN/MAX LEVEL		
Day	Min	Max
1	1	16
3	2	16
6	3	16
10	4	16
14	5	21
21	6	21
35	7	21
0	0	0
0	0	0
0	0	0

- Day: Set growth day
- Min: Set minimum ventilation level for controller

- **Max:** Set maximum ventilation level for controller

*NOTE BY DAYS CURVE generates an incremental increase/decrease between the defined days. BY DAYS operates according to the min/max values of the day's min/max values until the following day defined is reached.*

### 3.5.2 BY TIME

MIN/MAX LEVEL		
From	Min	Max
06:00	1	6
10:00	4	8
13:00	6	12
18:00	8	15
21:00	1	3
00:00	0	0
00:00	0	0
00:00	0	0
00:00	0	0
00:00	0	0

- **From:** Set time of day (hh:mm) in 24-hour format
- **Min:** Set minimum ventilation level for controller
- **Max:** Set maximum ventilation level for controller

### 3.5.3 DAY SOFT MIN.

SOFT MIN/MAX LEVEL			
Day	Min Soft	Min	Max
1	1	11	16
3	2	11	16
6	3	11	16
10	4	11	16
14	5	11	21
21	6	11	21
35	7	11	21
0	0	0	0
0	0	0	0
0	0	0	0

- **Day:** Set growth day.
- **Min Soft:** Set minimum ventilation level for when temperature drops below heat temperature.
- **Min:** Set minimum ventilation level for when temperature is above heat temperature.
- **Max:** Set maximum ventilation level for controller.

#### 3.5.3.1 Soft Min/Max Level Help | Set Definitions

- ② *While viewing the Soft Min/Max Level menu: Press HELP, select SET and press ENTER.*

SYSTEM PARAMETERS	
SOFT MIN/MAX LEVEL	
Diff. Below Heat for Soft Min.	10.0
Temp Choice for Soft Min. ▶	ATTIC

- **Differential Below Heat for Soft Min:** Set the degree of difference from heat temperature (set in Temperature Curve) to switch minimum level from Min. to Soft Min.
- **Temp Choice for Soft Min:** Select inside/outside/attic temperature to control Minimum Level changes. The minimum level adjusts towards the Soft Min as this temperature falls. Above the heat temperature, the minimum level is at the Min setting.

As temperature rises, **INSIDE** and **ATTIC** stay at lowest ventilation level reached until average temperature gets to the heat setting, and then changes instantly. With the **OUTSIDE** selection, the minimum ventilation level increases gradually as temperature rises to the heat setting. This means inside and attic soft min vent choices to latch to the lowest level reached as long as the temperature remains below the heat setting.

### 3.5.4 BY WEIGHT

*NOTE Pig mode does not support Minimum Ventilation By Weight.*

The By Weight option enables controlling the minimum air flow depending on the number of birds, their weight, and the current outside temperature. When using the Weight option, the controller takes several parameters and calculates the air speed, level of ventilation and cycle time needed to supply the required volume. As opposed to the other ventilation methods, the Weight option is dynamic, with the ventilation changing according to the current parameters (quantity of air required, weight of birds and number of birds, outside air temperature). In addition, Ventilation By Weight sends out an alarm if the current ventilation is below the minimum required level.

**To set up the Weight Option:**

1. In *Install > Setup* (page 138) enable Minimum Vent (Power).
2. In *Install > Temperature Definition*, define at least one temperature sensor as Outside.
3. In *Install > Fan Air Capacity*, define the air capacity / hour (page 149).
4. In *Scale > General Setting*, select the curve.
5. In *Scale > Bird Curve*, define the growth days and weights as required.
6. In *Control > Control Mode > Min. Max Level Control* menu, select **Weight**.
7. In *Control > Min/Max Level*, set the parameters as required.

<b>SOFT MIN/MAX LEVEL BY WEIGHT (OUT TEMP)</b>				
Day	Min Level	Air Per Kg/Lb		Max Level
		Cold	Warm	
1	1	0.5	1.5	16
3	1	0.5	1.5	16
6	1	0.5	1.5	16
10	4	1.1	1.7	16
12	4	1.1	1.7	21
15	7	1.1	1.7	21
17	7	1.1	1.7	21
19	7	1.1	1.7	21
21	7	1.1	1.7	21
35	7	0	1.7	22

- Day: Set growth day

- **Minimum Level:** Set the minimum level of ventilation (refer to Levels of Ventilation, page 51)
- **Air Per Kg/Lb:** Volume of air per kilogram/pound per hour per bird.
  - Cold: Volume of air supplied when the outside temperature goes down to the *Cold Temperature* parameter (see the following section).
  - Warm: Volume of air supplied when the outside temperature reaches *Warm Temp. – Diff Below Heat* (see the following section).

*NOTE As the level rises between days (for example between day 6 and day 10 in the screen above), the air volume rises proportionally each day, once a day. For example, on Day 7, the Cold Air per Kg/Lb rises to 0.65; on Day 8, 0.8 and so on.*

- **Maximum Level:** Set the maximum level of ventilation (refer to Levels of Ventilation, page 51).

8. In *Management > Bird Inventory*, type the number of birds.

9. In the Help menu, define the parameters as required.

### 3.5.4.1 Min/Max Level By Weight Help | Set Definitions, Version 6.18 and Below

- ② *While viewing the Min/Max Level by Weight menu: Press HELP, select SET and press ENTER.*

SYSTEM PARAMETERS	
SOFT MIN/MAX LEVEL BY WEIGHT	
Warm Temp. – Diff Below Heat	2.0
Cold Temperature	68.0
Air Change	0.24
Fan Cycle Time (sec, 0 – Manual)	600
Minimum ON Time in Vent Cycle	60
Minimum OFF Time Vent Cycle ▶	60
Air Change by Humidity/CO2 %	20
Air Per Weight Curve Mode	2

- **Warm Temperature – Difference Below Heat:** Differential below the heat temperature (refer to Temperature Curve, page 19) that defines outside temperature as Warm in the Soft Min/Max table. For example, if the Heat Temperature is 78° F, Warm Temp. – Diff Below Heat is 2.0, than the outside temperature is defined as warm at 76° F.
- **Cold Temperature:** Outside temperature (or below) at which Air per Kg/Lb (Cold) capacity is reached.

When the outside temperature is between the Warm and Cold Temperature, the flow rate is calculated at a proportional rate.

- **Air Change:** As the temperature rises from the Cold Temperature parameter to the Heat Temperature (or drops from the Heat Temperature to the Cold Temperature parameter), the minimal air volume rises/falls proportionally. Air Change defines the minimal change in air temperature that must take place to cause a change in the air supply.
- **Fan Cycle Time:** The total amount of time that the fans operate while operating under Minimum Ventilation. During this time, the fans supply the required volume of air at the minimum ventilation level required. Platinum Pro/Rotem Pro adjusts

the minimum ON time and OFF time as needed. If the fans cannot supply the required volume at a particular level of ventilation, the controller automatically adjusts the minimum ventilation level.

- **Minimum ON Time in Vent Cycle:** The minimum amount of time that the fans operate during a cycle. The controller adjusts the actual fan time as needed.
- **Minimum OFF Time in Vent Cycle:** The minimum amount of time that the fans do not operate during a cycle. The controller adjusts the actual fan time as needed.

As the temperature rises, the actual Minimum OFF Time decreases until it reaches the minimum time. Only then does the Minimum On Time begin to rise.

*NOTE If the temperature goes above the Band Temperature, Power Ventilation begins and times are adjusted accordingly.*

- **Air Change By Humidity/CO2/Ammon%:** As the humidity, CO2, or ammonia levels rise above the levels specified in Humidity Treatment, CO2 Treatment, or Ammonia Treatment the minimal air volume rises proportionally. Air Change By Humidity/CO2/Ammon% defines the minimal change in these levels that must take place to cause an increase in the air supply.
- **Air Per Weight Curve Mode:** By default, Air per Kilo/Lb has two data points: cold temperature and warm. If desired, the user can add an additional intermediate (computer defined) data point which is between the two default points. This point determines the quantity of air to be distributed when the temperature reaches the midpoint between the cold and warm temperatures.

SOFT MIN/MAX LEVEL BY WEIGHT (OUT TEMP)					
Day	Min Level	Air Per Kg/Lb		Max Level	
		Cold	Warm		
1	1	0.5	0.9	1.5	16
3	1	0.5	0.9	1.5	16
6	1	0.5	0.9	1.5	16
10	4	1.1	1.4	1.7	16
12	4	1.1	1.4	1.7	21
15	7	1.1	1.4	1.7	21
17	7	1.1	1.4	1.7	21
19	7	1.1	1.4	1.7	21
21	7	1.1	1.4	1.7	21
35	7	0	1.4	1.7	22

*NOTE In a three-point curve, the intermediate value must be between the cold and warm value in each line.*

### 3.5.4.2 Min/Max Level By Weight Help | Set Definitions Version 6.19

Version 6.19 has an additional parameter, Medium Temp, which enables setting up a more accurate temperature curve in Air by Weight. By default, the curve is determined by the Air per Kg/Lb Cold and Warm Temperatures. Medium Temp adds an additional (user-defined) point to the curve.

To add the Medium Temp point:

1. Configure Air by Weight as shown in By Weight, page 35.
2. Go to Control > Min/Max > Help and configure the parameters (refer to Min/Max Level By Weight Help | Set Definitions, Version 6.18 and Below, page 36 for details).
3. In the Help screen, define the Air per Weight Curve Mode:

- Using the number pad keys to define the mode as 2 or 3.
  - If set to 2, the Medium Temp parameter is disabled.
  - If set to 3, define the Medium Temp parameter.

SYSTEM PARAMETERS	
SOFT MIN/MAX LEVEL BY WEIGHT	
Warm Temp. – Diff Below Heat	2.0
Medium Temp	72.0
Cold Temperature	68.0
Air Change	0.24
Fan Cycle Time (sec, 0 – Manual)	600
Minimum ON Time in Vent Cycle	60
Minimum OFF Time Vent Cycle ▶	60
Air Change by Humidity/CO2/Ammon% %	20
Air Per Weight Curve Mode	3

- It can be no lower than the Cold Temperature.
- It can be no higher than the Warm Temperature minus Warm Temp. – Diff below Heat differential.
- Go to the Control Menu screen, re-enter the Mini/Max screen, and the Medium Weight parameter appears.

SOFT MIN/MAX LEVEL BY WEIGHT (OUT TEMP)					
Day	Min Level	Air Per Kg/Lb			Max Level
		Cold	Med	Warm	
1	1	0.5	0.9	1.5	16
3	1	0.5	0.9	1.5	16
6	1	0.5	0.9	1.5	16
10	4	1.1	1.4	1.7	16
12	4	1.1	1.4	1.7	21
15	7	1.1	1.4	1.7	21
17	7	1.1	1.4	1.7	21
19	7	1.1	1.4	1.7	21
21	7	1.1	1.4	1.7	21
35	7	0	1.4	1.7	22

### 3.5.4.3 Weight Hot Screen

Selecting the Ventilation by Weight option enables an additional Hot Screen, the Air Status Screen. This screen displays the critical parameters involved in the Ventilation by Weight option.

AIR STATUS				
Inside Temp				24.1
Outside Temp				21.3
Humidity				46.7%
Weight KG				0.468
		Current	Min	Max
Level		2	1	2
Cycle On		30	30	30
Cycle Off		98	134	66
Total Air M3/h	M3/h	8347	6552	11232
Air/WGT	M3/kg	0.9	0.7	1.20

- Inside Temperature: Current temperature inside the house
- Outside Temperature: Current temperature outside the house

- **Humidity:** Current relative humidity inside the house (requires a humidity sensor)
- **Weight KG:** Current average weight of the Bird Curve (page 106)
- **Level:** Displays the current, minimum, and maximum level of ventilation.

*NOTE If the current level is below the minimum required level, the controller displays an alarm "Below Min Air".*

- **Cycle On/Off:** Displays the current, minimum, and maximum fan on and off times.
- **Total Air M3/h:** Displays the current, minimum, and maximum quantity of ventilation, per hour.
- **Air/WGT:** Displays the current amount of ventilation, per kilo/pound of bird weight.

## 3.6 Soft Maximum Levels

Platinum Pro Version 6.24 supports Soft Maximum Levels.

- Introduction
- Soft Minimum Screens
- Soft Min

### 3.6.1 INTRODUCTION

The Soft Maximum Level screen enables determining the maximum ventilation level according to the outside temperature. Soft Maximum Level works with all minimum and maximum level described in Min/Max Level.

- Cold Max refers to the maximum amount air to be supplied depending on the birds age and the cold outside temperature. The Cold Max temperature is set by subtracting the "Diff below heat for cold max" (defined in the Settings) from the Heat parameter.
- Warn Max refers to the maximum amount air to be supplied depending on the birds age and the warm outside temperature. The Warm Max temperature equals the Temperature Curve Heat parameter.
- Between these points, Platinum determines the ventilation according to a curve.

*NOTE If the outside temperature sensor fails, the maximum level equals the warm maximum.*

- In Temperature Definition, page 148 designate at least one temperature sensor as an outside temperature sensor.

To enable Soft Maximum Levels

1. Go to Control > Control Mode.

CONTROL MODE	
Growing Zone	FULL HOUSE
House Mode	NORMAL
Temperature Curve	YES
Min. Max. Level Control	BY WEIGHT
Soft Maximum Level	YES
Heat Cycle	NO
Analog Heat Mode	LINEAR
THI Mode	NO
Cooling Ramping	NO

2. Set Soft Maximum Level to YES.
3. Go to Control > Min/Max Levels and define the minimum/maximum ventilation levels.
  - Cold Max Range: From the Minimum Level to Warm Max. Default 30
  - Warm Max Range: From Cold Maximum Level to 30. Default 30
4. Go to Control > Min/Max Levels > Settings.

SYSTEM PARAMETERS	
MIN/MAX	
Diff below Heat-Off to Cold Min	10.0

5. Define:
  - Diff below heat-off to Cold Max: Below this temperature, ventilation operates according to the Cold Max setting. Define the Heat Off parameter in Temperature Curve, page 19.

### 3.6.2 SOFT MINIMUM SCREENS

- By Days and By Soft Days Curve

MIN/MAX LEVEL			
Day	Min	Cold Max	Warm Max
1	1	1	30
3	2	1	30
6	3	1	30
10	4	2	30
14	5	2	30
21	6	3	30
35	7	4	30
0	0	0	0
0	0	0	0
0	0	0	0



- By Time

MIN/MAX LEVEL			
From	Min	Cold Max	Warm Max
06:00	1	1	30
10:00	4	1	30
13:00	6	1	30
18:00	8	2	30
21:00	1	2	30
00:00	0	3	30
00:00	0	4	30
00:00	0	0	0
00:00	0	0	0
00:00	0	0	0

- Soft Minimum: Refer to Soft Min Max Levels, page 41.
- By Weight

SOFT MIN/MAX LEVEL BY WEIGHT (OUT TEMP)					
Day	Min Level	Air Per Kg/Lb		Cold Max	Warm Max
		Cold	Warm		
1	1	0.5	0.9	1	16
3	1	0.5	0.9	1	16
6	1	0.5	0.9	2	16
10	2	1.1	1.4	3	16
12	2	1.1	1.4	5	21
15	3	1.1	1.4	5	21
17	3	1.1	1.4	5	21
19	3	1.1	1.4	7	21
21	4	1.1	1.4	7	21
35	4	0	1.4	7	22

### 3.6.3 SOFT MIN MAX LEVELS

In this function, the user defines minimum and maximum ventilation levels for cold and warm temperatures, enabling Platinum Pro to adjust the ventilation at both cold and warm temperatures.

1. Define the screen's cold and warm minimum/maximum levels.

SOFT MIN/MAX LEVEL				
Day	Cold Min	Warm Min	Cold Max	Warm Max
1	1	11	5	30
3	2	11	5	30
6	3	11	5	30
10	4	11	6	30
14	5	11	6	30
21	6	11	6	30
35	7	11	7	30
0	0	0	0	0
0	0	0	0	0
0	0	0	0	0

6. Go to Settings.

SYSTEM PARAMETERS	
SOFT MIN/MAX LEVEL	
Diff below Heat-Off to Cold Min	15.0
Ref. Temperature For Cold Min	ATTIC
Diff Below Heat Off for Cold Max	5.0

7. Define:

- Differential Below Heat for Cold Minimum: Below this temperature, ventilation operates according to the Cold Min setting. Define the Heat Off parameter in Temperature Curve, page 19. Range: 0 - 99°. Default 10°
  - Reference Temperature For Cold Min: Select inside/outside/attic temperature to control minimum level changes.
- In Temperature Definition, page 148 designate at least one temperature sensor as an outside temperature, inside, or attic sensor.
- Diff below heat-off to Cold Maximum: Below this temperature, ventilation operates according to the Cold Max setting. Define the Heat Off parameter in Temperature Curve, page 19.

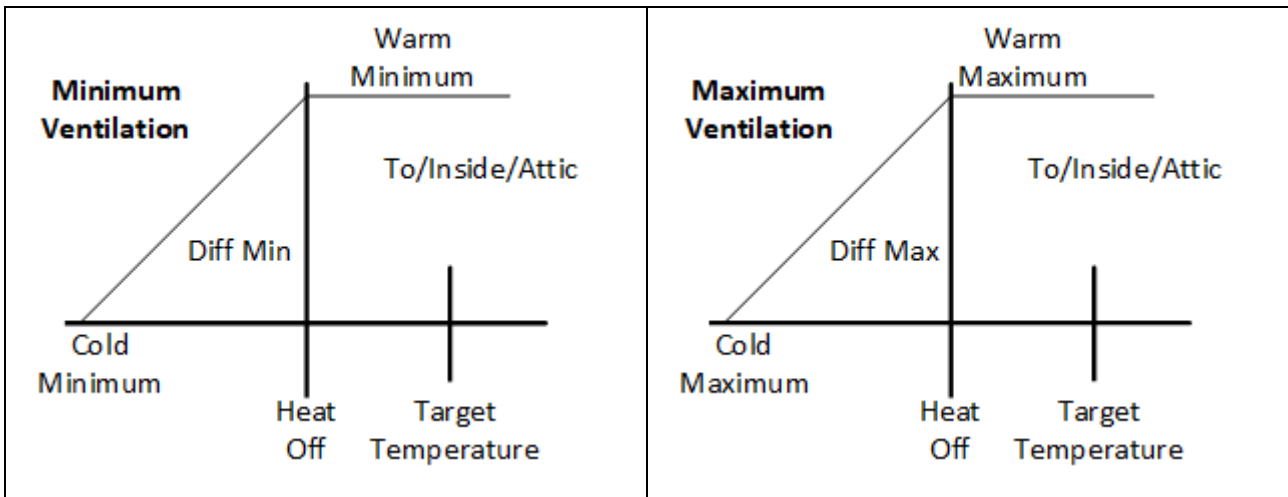

### 3.7 Static Pressure

Set target parameters for Static Pressure at High and Low Outside Temperatures, as well as alarms for high and low static pressure.

- In Installation > Setup, enable a static pressure unit.
- Refer to Static Pressure Calibration, page 123 and Static Pressure, page 119.

STATIC PRESSURE	
<b>Minimum Ventilation</b>	
S.Press. At Low Temperature	0.120
S.Press. At High Temperature	0.080
Low Static Pressure Alarm	0.010
High Static Pressure Alarm	0.150
Static Pressure Band	0.040
<b>Tunnel Ventilation</b>	
Target Static Pressure	0.080
Low Static Pressure Alarm	0.010
High Static Pressure Alarm	0.150
Static Pressure Band	0.040
<b>Attic</b>	
Target Static Pressure	0.050

- Disabling the Static Pressure Sensor
- Static Pressure Help | Set Definitions
- Multi Stage Tunnel Curtains

#### Minimum Ventilation

- **Static Pressure at Low Temperature:** Set desired static pressure for low outside temperature conditions. Be sure that there is proper airflow at this setting.
- **Static Pressure at High Temperature:** Set desired static pressure for high temperature conditions. Normally this pressure is lower to obtain a larger air inlet opening.

*NOTE Controller interpolates between the LOW and HIGH Temperature. If Static Pressure exists, then it is controlled by the outside temperature sensor, otherwise the average temperature.*

- **Low Static Pressure Alarm:** Set alarm for low static pressure. If you disable it by setting zero, the controller warns you and enters a record in the Table of Events.
- **High Static Pressure Alarm:** Set alarm for high static pressure.
- **Static Pressure Band:** Set desired band for the target pressure.

#### Tunnel Ventilation

- **Target Static Pressure:** Set required static pressure for Tunnel Ventilation Mode.
- **Low Static Pressure Alarm:** Set alarm for low static pressure.
- **High Static Pressure Alarm:** Set alarm for high static pressure.
- **Static Pressure Band:** Set required band for pressure in tunnel ventilation mode.

#### Attic

- **Target Static Pressure:** Set required static pressure when in attic mode.
- **Static Pressure Band:** Set required band for attic ventilation mode.

### 3.7.1 DISABLING THE STATIC PRESSURE SENSOR

To disable the static pressure sensor:

1. Go to *Installation* > *Setup*.
2. Set the Static Pressure Unit to *None*.

The main screen stops:

- displaying the pressure
- displaying High Pressure and Pressure Sensor Failure alarms

**NOTE:** *If either of these alarms were active before disabling the sensor, the main screen continues to display the alarms. Reset the alarms one time to cease the display.*

### 3.7.2 STATIC PRESSURE HELP | SET DEFINITIONS

- ① While viewing the Static Pressure menu: Press *HELP*, select *SET* and press *ENTER*.

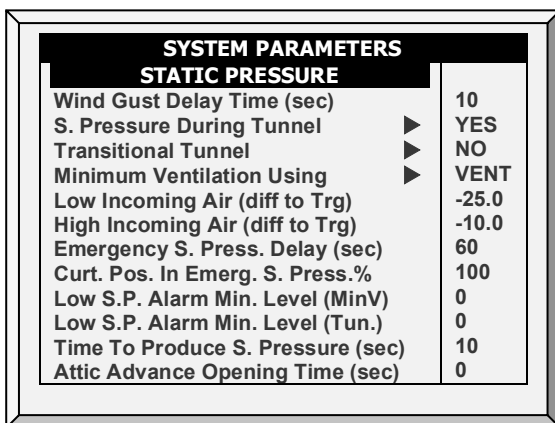

SYSTEM PARAMETERS	
STATIC PRESSURE	
Wind Gust Delay Time (sec)	10
S. Pressure During Tunnel	▶ YES
Transitional Tunnel	▶ NO
Minimum Ventilation Using	▶ VENT
Low Incoming Air (diff to Trg)	-25.0
High Incoming Air (diff to Trg)	-10.0
Emergency S. Press. Delay (sec)	60
Curt. Pos. In Emerg. S. Press. %	100
Low S.P. Alarm Min. Level (MinV)	0
Low S.P. Alarm Min. Level (Tun.)	0
Time To Produce S. Pressure (sec)	10
Attic Advance Opening Time (sec)	0

- **Wind Gust Delay Time (seconds):** Set length of time in seconds before starting Static Pressure control after an unexpected change in air pressure.
- **Static Pressure During Tunnel:** Select YES or NO for using Static Pressure control when in Tunnel mode.
- **Transitional Tunnel:** Select YES or NO for using tunnel curtains when static pressure is high and vents are already at 100%.
- **Minimum Ventilation Using (vent/curtain):** Select VENT or CURTAIN for controlling static pressure when in minimum ventilation.
- **Low Incoming Air (Difference to Target):** Define low temperature for static pressure control.
- **High Incoming Air (Difference to Target):** Define high temperature for static pressure control.
- **Emergency Static Pressure Delay (seconds):** Set length of time in seconds before initiating an emergency opening when pressure exceeds high alarm setting.
- **Curtain Position in Emergency Static Pressure (%):** Set the desired curtain position (in percentage) when an emergency pressure event occurs.
- **Low Static Pressure Alarm Minimum Level (MinV):** Below this level, the controller ignores low static pressure alarms.
- **Low Static Pressure Alarm Min. Level (Tunnel):** Below this level, the controller ignores low static pressure alarms while in tunnel mode.

- **Time to Produce Static Pressure (seconds):** Enter the length of time to reach target pressure when minimum ventilation fan cycle is on.
- **Attic Advance Opening Time (seconds):** Define the amount of time for the attic inlets to open before minimum vent cycling fans turn on.

### 3.7.3 MULTI STAGE TUNNEL CURTAINS

When in static pressure mode and employing multiple tunnel curtains, the controller can open the curtains in sequence. Opening the tunnel curtains commences when the target static pressure is reached and the controller signals the tunnel machine to operate the curtains. the controller opens the first tunnel curtain (as defined in the relays) to the user defined level. If additional ventilation is required, the second tunnel curtain opens. This process continues for each defined curtain.

As pressure falls, the process is reversed; curtains close in progression starting with the last curtain.

To set up Multi Stage Tunnel Curtains:

1. In *Installation > Relays* define more than one relay as tunnel curtain (open and close).
2. In *Device > Vent & Curtain Levels*, define the opening levels for each curtain.
3. In *Static Pressure > Tunnel Ventilation*, define the target pressure.

## 3.8 Control Mode

- Control Mode Main Screen
- Catching Mode

### 3.8.1 CONTROL MODE MAIN SCREEN

Use this screen to define various basic controls that define the house functionality.

CONTROL MODE	
Growing Zone	FULL HOUSE
House Mode	NORMAL
Temperature Curve	YES
Min. Max. Level Control	BY WEIGHT
Soft Maximum Level	YES
Heat Cycle	NO
Analog Heat Mode	LINEAR
THI Mode	NO
Cooling Ramping	NO

- **Growing Zone:** Select whether the house is in one of the brood set ups or in full house.
- **House Mode:** Select:
  - Normal
  - Empty: All alarms and functions are disabled
  - Catching: Refer to Catching Mode.
- **Temperature Curve:** If you select OFF, temperature settings become fixed values until midnight on the next setting in Temperature Curve (page 19).

- **Min. Max. Level Control:** Set ventilation control method (By Days, By Days Curve, By Time, By Soft Min, and Weight). Refer to Min/Max Level, page 33 for more details)
- **Soft Maximum Level:** Refer to Soft Maximum Levels, page 39 (Version 6.24 and higher)
- **Heat Cycle:** Enable cycle heaters. Refer to Cycle Heaters | Set Definitions, page 23.
- **Analog Heat Mode:** Define the variable heating mode (Linear, Proportional, Linear Valve). Refer to Variable Heater Help | Set Definitions, page 24.
- **THI Mode:** Enables Temperature Humidity Index. Refer to Temperature Humidity Index, page 27.
- **Cooling Ramping:** Enables cooling ramping (Version 6.22). Refer to Cool Pad (Ramping), page 62.

### 3.8.2 CATCHING MODE

SYSTEM PARAMETERS	
CONTROL MODE	
Growing Zone	FULL HOUSE
House Mode	CATCHING
Temperature Curve	YES
Min. Max. Level Control	BY WEIGHT
Heat Cycle:	NO
Analog Heat Mode	LINEAR
THI Mode	NO

Catching Mode is used when birds are being removed from the chicken house. In this mode:

- You can limit light intensity and ventilation.
- The following functions are disabled.
  - Humidity/CO2/Ammonia treatment
  - Heating
  - Foggers
  - Water and feed
  - WOD
  - Nipple flushing
  - Feeders and drinkers control
- High/low temperature and high static pressure alarms are active. All other alarms are disabled.

#### To configure Catching Mode.

1. In Control > Control Mode, define House Mode as Catching.
2. In Control > Control Mode > Settings define:
  - Light Intensity: Default 0%, range 0-100%
  - Temp & Pressure Alarms Enable: Define as Yes or No.
  - Level of Ventilation: 0 means ventilation works automatically. 1 – 30 sets the ventilation mode.

### 3.9 System Parameters

System Parameters consolidates all of the **HELP | SET** menus into one scroll screen.

System parameter	Page	System parameter	Page
Temperature Curve Help   Set	20	Levels of Ventilation Help   Set	53
Radiant Heaters Help   Set	22	Cool Pad Help   Set	61
Humidity Treatment Help   Set	30	Foggers Help   Set	65
Day Soft Min.	34	Light Help   Set	67
Disabling the Static Pressure Sensor	44	Feed Inventory Help   Set	90

### 3.10 Ammonia Treatment

- Ammonia Main Screen
- Ammonia Treatment Help | Set Definitions

#### 3.10.1 AMMONIA MAIN SCREEN

Ammonia treatment forces an increase in ventilation level when the ammonia level is too high. To prevent fans changing their ventilation too often, treatment begins after a user-defined delay. The user also defines the treatment duration.

After the treatment, the ventilation level may come back down automatically if the house temperature is below the target temperature. Otherwise, the ventilation level does not change. If during treatment, the ammonia level drops below the **Stop Value** parameter, the ventilation level automatically returns to that level used before ammonia treatment began.

AMMONIA TREATMENT				
Day	Start Value	Stop Value	Delay (Sec)	Duration Sec.
1	25	10	120	130
7	25	10	120	150
14	25	10	90	180
0	25	10	0	0
0	25	10	0	0
0	25	10	0	0
0	25	10	0	0
0	25	10	0	0
0	25	10	0	0
0	25	10	0	0

➤ This function requires an ammonia sensor.

1. In *Install > Analog Sensors* (refer to Analog Sensors), designate one sensor as an ammonia sensor.
2. If required, go to *Service > Ammonia* and calibrate the sensors (refer to Ammonia Calibration).
3. In *Control > Ammonia Treatment* set the parameters.
  - **Day:** Growth day. You can set multiple programs for same day (maximum number of programs: 20)
  - **Start Value:** Ammonia value at which to begin treatment. Range: 0 to 100. Default: 2

*NOTE Ammonia levels should not be higher than 30 ppm.*

- **Stop Value:** Ammonia value at which to end treatment. Range: 0 to 100. Default: 2. The stop value must be lower than the start value.
- **Delay (Sec):** When the ammonia level reaches the start value, the controller delays treatment for this amount of time. Default: 0
- **Duration (Sec):** Number of seconds the controller maintains the increased level of ventilation. Default: 0

4. Set the Ammonia Alarm (page 96).

### 3.10.2 AMMONIA TREATMENT HELP | SET DEFINITIONS

- ② *While viewing the Ammonia Treatment menu: Press HELP, select SET, and press ENTER.*

SYSTEM PARAMETERS	
AMMONIA TREATMENT	
Ammonia Treatment Below Heat	No
Ammonia Treatment By	Level

- **Ammonia Treatment below Heat:** Select: Select YES or NO to enable Ammonia Treatment when heaters are operating (set in Temperature Curve).
- **Ammonia Treatment By:** This parameter designates the method used when ammonia treatment begins. Normally, this parameter is relevant only when minimum ventilation is running. When a treatment is required, select the method to be employed:
  - **Level:** Increases the ventilation level when a treatment is required.

*NOTE When employing Ventilation by Weight, the controller increases the cycle time or the level, depending on the particular settings.*

- **Exhaust:** Designate a specific exhaust fan (press a number key to select the fan).
- **Tunnel:** Designate a specific tunnel fan (press a number key to select the fan).
- **None:** Disables the treatment.

## 3.11 Water Dosing

Platinum Pro/Rotem Pro Version 6.20 supports specific dosing pumps used to inject additives into the water supply. From the controllers you can define the type of pump used, the additive, dosage rate, and additive amount.

- Dosing Pump Main Screen
- Dosing Pump Settings Screen
- Dosing Hot Screen

*NOTE Version 6.20 supports one pump. Version 6.22 supports up to four pumps. All pumps use the same additive and dosage rate.*



### 3.11.1 DOSING PUMP MAIN SCREEN

1. In Install > Digital Sensor, select Pump Cycle Meter (one).
2. In Install > Digital Sensor, select Pump Additive Over (optional).
3. Repeat for each set of sensors (Version 6.22).
4. Go to Control > Dosing Pump.

DOSING PUMP SETTINGS	
Pump #	1
Pump Type	0.8 Fixed
Additive Name	None
Dosage Rate	0.8
Additive Amount (gal)	0

5. Define:

- Pump #: Select the number of the pump for which you want to edit the parameters.
- Pump Type: Select the type of pump being used.
  - 0.8 Fixed: This pump provides a fixed dosage rate (0.8%).
  - 0.3 – 2 Variable: This pump provides a variable rate between 0.3 to 2.5%.
- Additive Name: Select an option from the list.
- Dosage Rate: If you defined the pump type as variable, define the dosage rate. Default: 0.8%
  - The dosage volume per pulse is 400 cc (water and additive). The dosage volume of the additive is 400 x the rate. For example 400 x 0.8 = 3.2 cc.
- Additive Amount: Define the number of liters of additive.

### 3.11.2 DOSING PUMP SETTINGS SCREEN

- ② When viewing the Dosing Pump Settings Menu: Press *Help*, select *Set*, and press *Enter*.

Dosing	
Dosing Shortage Alarm Time (sec)	20

- Dosing Shortage Alarm Time (sec): Define the amount of time that must pass when additives cease to be added before an alarm is triggered. Range: 1 – 9999 seconds. 0 disables the alarm. Default: 20.

### 3.11.3 DOSING HOT SCREEN

Press the 2 and Up Arrow to view the Dosing Hot Screen.

DOSING MEASUREMENTS			
Additive	Work Time	Water (gal)	Dose (gal)
1 None	00:00:00	0.0	0.000
2 None	00:00:00	0.0	0.000
3 None	00:00:00	0.0	0.000
4 None	00:00:00	0.0	0.000

# 4 Device Menu

The Platinum Pro/Rotem Pro can have many closely spaced levels of ventilation enabling it to find the optimum average airflow for the poultry or pig facility. Many of the levels are at exactly the same temperature setting, so there may be a question as to how the Controller chooses the correct level.

The menus in this section apply levels to ventilation, variable speed fans, curtains, and other related matters. The levels in the various menus are consistent with each other so that a level in one menu corresponds with that level in any other menu.

The rules that apply here are:

- Rule 1: If the temperature is at target (in the Happy Zone) stay at the current level.
- Rule 2: If the temperature moves outside the Happy Zone; have some patience.
- Rule 3: After the designated delay, increase or decrease levels appropriately.

You can find the 'patience' factors under [HELP | SET](#) in this menu. They are the *increase level delay* and *decrease level delay* parameters. The factory default values are 180 seconds for an increase and 60 seconds for a decrease.

The factory default values bias the Controller slightly toward warmer temperatures, as would be appropriate for young birds. The level increase delay is longer than the level decrease delay. You may wish to reverse these values by the time you have market age broilers, since they are more sensitive to heat stress than to cold.

Although many of the levels have 0.0 differential temperatures, certain levels should have differentials to account for wind chill on the birds. The first tunnel level accounts for wind chill by switching to the tunnel temperature instead of target temperature. Higher tunnel levels require an additional wind chill because of the increased airflow.

In addition, the last few levels before entering tunnel can form a transitional region. You may want to build differentials from target temperature just before the first tunnel level.

The controller obeys both the time delay rules and the differential temperature rules when changing levels. Tunnel exit has several additional rules, such as outside temperature restriction and the tunnel exit delay described under [HELP | SET](#). In addition, there are Cool Down and change to Min Vent on reaching the Heat temperature features described in [Control | Temperature Curve | HELP | Set](#) parameters.

The following sections detail the menu functions.

- Levels of Ventilation, page 51
- Variable Speed Fan Levels, page 54
- Vent & Curtain Levels, page 55
- Stir Fan Levels, page 56
- Stir Fan Program, page 58
- Cool Pad, page 60
- Foggers, page 62
- Light, page 66
- Water & Feed, page 70
- Extra Systems, page 74
- Water on Demand, page 74
- Natural Program, page 76
- Feed Scale Program, page 82

DEVICE SETTING
1. LEVELS OF VENTILATION
2. SPEED FAN LEVELS
3. VENT & CURTAIN LEVELS
4. STIR FAN LEVELS
5. STIR FAN PROGRAM
6. COOL PAD
7. FOGGERS
8. LIGHT
9. WATER & FEED
10. EXTRA SYSTEMS
11. WATER ON DEMAND
12. NATURAL PROGRAM
13. FEED SCALE PROGRAM

## 4.1 Levels of Ventilation

- Levels of Ventilation Main Screen
- Levels of Ventilation Help | Set Definitions
- Wind Chill

### 4.1.1 LEVELS OF VENTILATION MAIN SCREEN

The Precision Ventilation table provides up to 30 ventilation levels. To program this table, start with the minimum ventilation used in the first level and increase ventilation gradually. A reasonable rule of thumb is to increase the airflow by about 25% at each level. Increases in airflow up to 50% work satisfactorily with factory default settings.

1. Do one or both:
  - In *Install* > *Relay Outlet*, define at least one relay as a Tunnel Fan or Exhaust Fan.
  - In *Install* > *Analog Output*, define one function as Tunnel Fan or Exhaust Fan.
2. In *Device Setting* > *Levels of Ventilation* configure the parameters as required.
3. Configure the Help Set parameters as required.

LEVELS OF VENTILATION								
No	Diff Deg.	On Sec	Exhaust			Tunnel		
			1	2	3	1	2	3
1	0.0	30	◇	◇	◇	▪	▪	▪
2	0.0	45	◇	◇	◇	▪	▪	▪
3	0.0	60	◇	◇	◇	▪	▪	▪
4	0.0	80	◇	◇	◇	▪	▪	▪
5	0.0	120	◇	◇	◇	▪	▪	▪
6	0.0	160	◇	◇	◇	▪	▪	▪
7	0.0	200	◇	◇	◇	▪	▪	▪
8	0.0	250	◇	◇	◇	▪	▪	▪
9	0.0	100	◇	◇	◇	▪	▪	▪
10	0.0	120	◇	◇	◇	▪	▪	▪
11	0.0	150	◇	◇	◇	▪	▪	▪
12	0.0	180	◇	◇	◇	▪	▪	▪
13	0.0	0	◇	◇	◇	▪	▪	▪
14	0.0	150	◇	◇	◇	▪	▪	▪
15	0.0	0	◇	◇	◇	▪	▪	▪
16	0.0	0	◆	◆	◆	◆	◆	◆

0.0.  
Air Capacity: 300                      -Continuous  
Chill Range:                            --- -Cycle  
    -Rotate  
    Tunnel Level: T

NOTE The number appearing under Exhaust and Tunnel refers to the numbers defined in Installation.

- Number: Read-only showing the ventilation level.

NOTE At the First Tunnel Level (defined in the Help | Set Definitions) the screen displays the tunnel temperature (defined in Temperature Curve). **T** means the level is in tunnel mode.

- Differential Temperature: Triggers next level according to difference from target temperature (time delays remain in effect).
  - The first several levels normally have differential temperatures set to 0.
  - If the ventilation level is below tunnel, the differential temperature is relative to the Target temperature given in Temperature Curve.
  - If the ventilation level is a tunnel level, the differential temperature is relative to the Tunnel temperature given in Temperature Curve.
- Cycle timer ON: Set ON time for fans for that ventilation level.
- Cycle timer OFF: Set OFF time for fans of that ventilation level. This parameter disappears if cycle time is set in the [HELP | SET](#) Parameters to something other than 0 and the controller calculates the "Cycle timer OFF" automatically.
- Exhaust: Control exhaust fans according to Continuous, Cycle, and Rotate.
- Tunnel: Control tunnel fans according to Continuous, Cycle, and Rotate.

NOTE A ~ appearing next to Exhaust or Tunnel means that fan is a variable fan.

- Air Capacity: Displays the current exhaust fan or tunnel air flow for each ventilation level. If Variable Speed Fan Levels have been set (refer to page 54), the speed percentage is taken into account.



Continuous: Works constantly without a break



Cycle: Operates according to ON/OFF timer



Rotate: Operates according to ON/OFF timer; in each cycle a different fan operates

## 4.1.2 LEVELS OF VENTILATION HELP | SET DEFINITIONS

- ② When viewing the Levels of Ventilation menu: Press *Help*, select *Set*, and press *Enter*.

SYSTEM PARAMETERS	
LEVELS OF VENTILATION	
Maximum Levels of Ventilation	22
First Tunnel Level	5
Max Fans, Switch to Tunnel	20
Tunnel Exit – Diff Below Tunnel	2.0
Tun Exit-Out T. Diff from Tun.	9.0
Increase Level Delay Time (sec)	120
Decrease Level Delay Time (sec)	90
Fan Cycle Time (sec, 0-Manual)	0
Tunnel Exit Delay (minutes)	2
Wind Chill Enable	NO
Wind Chill Limit	14.4
RH Effect	0.5

- Define:
  - **Maximum Levels of Ventilation:** Set the maximum number of levels.
  - **First Tunnel Level:** Set the entry point to tunnel mode.
  - **Max Fans, Switch to Tunnel:** Set the maximum number of fans allowed to operate when entering tunnel mode.
  - **Tunnel Exit – Differential Below Tunnel:** Set degree of difference below Tunnel temperature (set in Temperature Curve) to Exit Tunnel mode.
  - **Tunnel Exit – Outside Differential from Tunnel:** The outside temperature must read below this (Tunnel + Differential) to allow exiting from tunnel mode.
  - **Increase Level Delay Time (sec):** Set length of time in seconds before transitioning to next level.
  - **Decrease Level Delay Time (sec):** Set length of time in seconds before transitioning to lower level.
  - **Fan Cycle Time (sec):** If set to 0, set on and off times for each level manually. If you are using a fixed cycle time, such as 300 seconds, enter it here and enter only the On time at each level. Default: 0
  - **Tunnel Exit Delay (minutes):** Set length of time in minutes before exiting Tunnel mode. This time begins once all other parameters are satisfied.
  - **Wind Chill:** Refer to the following section.

## 4.1.3 WIND CHILL

Platinum Pro/Rotem Pro can take into consideration the wind chill factor when making certain calculations related to the temperature. In effect, the wind chill factor acts as the temperature differential. When enabled, Platinum Pro/Rotem Pro determines the

“calculated temperature (actual temperature – wind chill temperature) and uses this temperature:

- When calculating the Tunnel Mode level up/down algorithms
- When operating the Cool Pad (if enabled in System Variables; refer to Operate Cool Pad, page 60).

The Wind Chill factor influences controller operation from the 1st tunnel level.

- The actual temperature: 1) determines the entry and exit into Tunnel Mode 2) controls the fogger.

Parameters:

- **Wind Chill:** Enable this parameter to include the wind chill factor in ventilation calculations. Default = No.
- **Wind Chill Limit:** Maximum wind chill factor value. Default = 8° C.
- **RH Effect:** The decrease in temperature caused by an increase in relative humidity. Default is 0.26° C.
  - The Relative Humidity Effect parameter enables including the relative humidity (RH) in the wind chill factor calculations. A rise in relative humidity reduces the wind chill factor. How does it work?
  - There is no effect below 40% relative humidity.
  - The user determines the increase in temperature for every 5% increase in relative humidity.
    - The default increase is 0.26° C; meaning that between 40.1% - 45% relative humidity, the wind chill factor decreases by 0.26° C. Between 45.1% - 50%, the wind chill factor decreases by 0.52° C, twice the default level. Between 50.1% - 55%, the decrease is 0.78° C, three times the default level, and so on.
    - The user can set the temperature increase as required.
    - To disable this feature, enter '0'.

## 4.2 Variable Speed Fan Levels

In the Variable Speed Fan Level table set the speed in percentages for up to four groups of fans by level.

 This function requires an Analog Output card in the controller.

This card sends a low voltage control signal to a Variable Speed controller to run the variable speed fan. Several kinds of speed controllers are available, such as TRIAC Control, and Variable Frequency 3 Phase drives.

VARIABLE SPEED FAN LEVEL			
Level	Tun 2	Exh 2	Exh 3
1	----	30	30
2	----	30	30
3	----	30	45
4	45	45	45
5	45	60	45
6	60	60	60
7	60	75	60
8	75	75	75
9	90	90	90
10	100	90	100

1. In *Install* > *Analog Output* (refer to *Analog Output*, page 143), define at least one output as a variable speed fan.

2. In *Device Setting* > *V. Speed Fan Levels*, define the fans' working percentages.

*NOTE* "----" appears when this variable fan is not defined as operating at this ventilation level.

3. In *Device Setting* > *V. Speed Fan Levels*, define the fans' working percentages.

### 4.3 Vent & Curtain Levels

- Vent & Curtain Main Screen
- Vent & Curtain Levels Help | Set Definitions

#### 4.3.1 VENT & CURTAIN MAIN SCREEN

Set the curtain levels to correspond with the ventilation levels. The operating mode determines the curtain control procedure.

*NOTE* Version 6.19 supports six tunnel curtains and four vents in *Broiler* and *Breeder* modes. Previous editions support four tunnel curtains and two vents.

*NOTE* Users employing *Layers Mode*, refer to *Layers Vent and Curtain Levels*, page 155.

1. In *Install* > *Relay Outlet* (refer to page 139), define at least one relay as *Curtain Open*, *Tunnel Open*, *Vent Open*, or *Attic Open*.

2. If your installation includes curtains, In *Install* > *Setup*, define *Natural Ventilation* as *Level* or *Power*.

*NOTE* When *Natural Ventilation* is *Off*, the *Curtains* don't appear in the screen.

3. In *Device Setting* > *Vent & Curtain Levels*, define the minimum opening percentages.

4. Press **Enter**.

5. If required, configure each opening to work with a particular temperature sensor. Refer to *Temperature Definition*, page 148.

6. Set the *Help Set* parameters as required.

VENT & CURTAIN LEVELS		
Level	Tunnel	Vent
1	0	15
2	0	15
3	0	15
4	0	15
5	0	15
6	0	15
7	0	15
8	0	15
9	0	15
10	0	15

- Ventilation Level: Read-only.
- Tunnel/Curtain/Vent/Attic: Set position for the tunnel curtain by level. If you have Static Pressure in Tunnel turned on ([Control](#) | [Static Pressure](#) | [Help](#) | [Set](#)), this becomes the minimum position for the tunnel inlet.

#### 4.3.2 VENT & CURTAIN LEVELS HELP | SET DEFINITIONS

Users employing Version 6.18 and below, refer to Appendix D: Previous Version Functions, page 181.

- ② *While viewing the Vent & Curtain Levels menu: Press **HELP**, select **SET** and press **ENTER**.*

SYSTEM PARAMETERS	
CURTAINS AND VENTS	
2nd Vent Operate From Day	-2
2nd Vent Operate From Level	1
3rd Vent Operate From Day	-2
3rd Vent Operate From Level	1
4th Vent Operate From Day	-2
4th Vent Operate From Level	1
ATTIC	
Minimum Attic Temp. To Operate	75
Operate Until Level	10
Operate From Time	0:00
Operate To Time	0:00
Max Temperatur to Disable Attic	100.0

#### Curains and Vents

- Vent Operate from Day: Define on which day vents 2, 3, or 4 begin to operate.
  - Vents must be defined in Installation > Relay Layout to operate.
  - To define Vents 2, 3, and 4:
    - Vent 1 must be operating.
    - Vents 2, 3, and 4 operate independently; however define lowered number vents before defining succeeding vents. For example, define Vent 2 before defining Vent 3.

#### 4.4 Stir Fan Levels

1. Do one or both:



- In *Install > Relay Outlet* (refer to page 139), define at least one relay as a Stir Fan or
- In *Install > Analog Output* (refer to Analog Output, page 143) define one function as Variable Stir Fan.

2. In *Device > Stir Fan Levels*, define the parameters as required.

STIR FAN LEVELS		
Level	Stir Fan No 23456789012345	Variable Fan 3 4
1	● ...	◀▶ ◊
2	● ...	◀▶ ◊
3	● ...	◀▶ ◊
4	...	◀▶ ◊
5	...	◀▶ ◊
6	...	◆ ◆
7	...	

●-Continuous ◀-Cycle On ○-Cycle Off

In the Stir Fan Level table set the speed in percentage that you want the variable speed fan to work at (by levels). For each level, program the stir fans' cycle. Configure the actual speed in Analog Output, page 143.

**NOTE** The numbers shown in the screen under Variable Fan depend on how you defined the fans in *Installation > Relay Layout and Analog Output*.

**NOTE** **T** means the level is in tunnel mode.

- Ventilation Level: Read only.
- Variable Speed Fan-1, 2, 3, 4: Set variable speed fan operation in percentages.
- Stir Fan: Control stir fans according to Continuous, Cycle On, Cycle Off (ventilation cycles are the same as previously set in [Levels of Ventilation](#). Press +/- to set the operation cycle.



Continuous: Constantly works without a break.



Cycle: Operates according to ON/OFF timer.



Rotate: Operates according to ON/OFF timer; in each cycle a different fan operates

**NOTE** The Stir Fans operate according to the levels you program in this menu, and according to the programs you select in the Stir Fan Program. The fan turns on if any program or level requests ON; all programs and levels must be OFF for the Stir Fan to be off.

## 4.5 Stir Fan Program

### 4.5.1 STIR FAN MAIN PROGRAM

This section contains five different programs that you can assign to each stir fan. Check the programs applying to each fan by using the '+/-' key (further explained in [STIR FAN PROGRAM HELP | SET](#)).

*NOTE* If the same variable stir fan is selected for different programs, the program having the highest fan speed operates.

NOTE: The ~ symbol designates an analog output device.

STIR FAN PROGRAM					
Fan No.	-A-	-B-	-C-	-D-	-E-
1	✓	✓	■	■	■
2	✓	■	✓	■	✓
3	■	✓	✓	✓	■
4	■	■	✓	✓	✓
5	■	■	■	■	■
6	■	■	■	■	■
7	■	■	■	■	■
8	■	■	■	■	■
ACTIVE	■	□	□	□	□

- **A (heaters):** This program corrects temperature variations lengthwise in the building. Insert diff and sensor numbers.
- **B (for min vent):** This program helps mixing minimum ventilation air for buildings having stir fans to mix the air coming in with warm inside air
- **C, D & E (sensors diff temperature):** These options create three stir fan groups which operate according to sensor differentials.

### 4.5.2 STIR FAN PROGRAM HELP | SET DEFINITIONS

- ② While viewing the Stir Fan Program menu: Press **HELP**, select **SET** and press **ENTER**.

SYSTEM PARAMETERS	
PROGRAM A (for min vent)	
Diff below Target to Operate:	0.6
Cycle On time (sec):	0
Cycle Off time (sec):	0
From Level	0
To Level	0
From Time (hh:mm)	00:00
To Time (hh:mm)	00:00
Stop During Fan Operation	YES
PROGRAM B (sensors diff temp)	
Operate after End of Cycle	YES
Delay for Operation	2.0
Time for Operation	5.0
From Level	0
To Level	0
From Time	00:00
To Time	00:00

### Program A (for Heaters)

- **Diff below Target to Operate:** Set the degree of difference below the target temperature for stir fans to operate.
- **Cycle On time (sec):** Define the length of time in seconds you would like the stir fan to operate during the cycle.
- **Cycle Off time (sec):** Define the length of time in seconds you would like the stir fan to be off during the cycle.
- **From/To Level:** Limit the program to operate between the levels defined.
- **From/To Time:** Define the time frame for the program to operate (24-hour format).
- **Stop During Fan Operation:** Select YES run the heaters when the fans are operating.

### Program B (for Min Vent)

- **Operate after End of Cycle:** Set when stir fan begins operating. It can be at the end of the ON cycle or the OFF cycle set in the [DEVICE | Levels of Ventilation](#).
- **Delay for Operation (sec) (+/-):** Define length of time in seconds from the end or start of cycle you chose in Operate after end of cycle above, for the stir fans to operate.
- **Time for Operation (sec):** Define length of time in seconds for the stir fans to operate.
- **From/To Level:** Limit the program to operate between the levels defined.
- **From/To Time:** Define the time frame for the program to operate (24-hour format).

### Program C, D, E (Sensors Diff Temp or Independent)

- **Temp Diff to Operate:** Set the degree of difference between sensors for stir fans to begin operating.

*NOTE If this parameter is set to 0 (zero), the variable stir fan runs independently of the sensors.*

- **Diff between Sensor Number:** Select a sensor to define one temperature reading.
- **Diff between Sensor Number:** Select a second sensor to define a temperature reading from a different area.
- **Cycle On time (sec):** Define the length of time in seconds you would like the stir fan to operate during the cycle.
- **Cycle Off time (sec):** Define the length of time in seconds you would like the stir fan to be off during the cycle.
- **From/To Level:** Limit the program to operate between the levels defined.
- **From/To Time:** Define the time frame for the program to operate (24-hour format).
- **Stop During Fan Operation:** Select YES run the heaters when the fans are operating.
- **Variable Stir Fan:** Select the stir fan to be used.
- **Min/Max Variable Stir Fan Speed:** Enter the minimum and maximum speed (in percentage).

## 4.6 Cool Pad

- Cool Pad (Standard)
- Cool Pad (Ramping)

### 4.6.1 COOL PAD (STANDARD)

The following section describes Cool Pad, Version 6.21 and below.

- Cool Pad Main Screen
- Cool Pad Help | Set Definitions

#### 4.6.1.1 Cool Pad Main Screen

This menu sets the Cool Pad operating conditions.

COOL PAD						
Day	Start Time	End Time	Tunnel Diff	To Hum	On sec	Off sec
1	10:00	21:00	3.0	99	15	285
7	10:00	21:00	3.0	99	15	285
7	10:00	21:00	5.0	99	45	255
14	10:00	21:00	2.0	99	15	285
14	10:00	21:00	3.0	99	30	270
14	10:00	21:00	4.0	99	45	255
14	10:00	21:00	5.0	99	60	240
14	10:00	21:00	6.0	99	75	225
14	10:00	21:00	7.0	99	100	200
14	10:00	21:00	8.0	99	200	100

- **Day:** Set growth day.
- **Start Time:** The cool pad begins operating at this time.
- **End Time:** The cool pad ceases to operate at this time.
  - It is possible to set multiple start and stop times for a single day.
  - In the screen above, growth day jumps from day 7 to day 14, the cool pad continues to work according to day 7 settings from growth day 7 through growth day 14.
- **Tunnel Differential:** Set difference from tunnel temperature to use this setting. You can use negative differential temperatures.
  - Note the settings for Day 14. The Controller uses the maximum temperature differential that applies to choose the correct settings.
- **To Humidity:** Set maximum humidity allowed before stopping cool pad. You can enter 100%.
- **On Sec:** Set the maximum on time for each cycle of cool pad operation.
- **Off Sec:** Set the minimum off time for each cycle of cool pad operation.

### 4.6.1.2 Cool Pad Help | Set Definitions

② While viewing the Cool Pad menu: Press **HELP**, select **SET** and press **ENTER**.

SYSTEM PARAMETERS	
COOL PAD	
Temperature Band	2.0
Humidity Band (%)	2
Diff Between Cool Pads Stage	0.0
Cool Pad-1 Min Level	1
Cool Pad-2 Min Level	1
Cool Pad-3 Min Level	1
Cool Pad-4 Min Level	1
COOL PAD FLUSH	
Flush Cool Pad At:	0:00
Cool Pad Flush Duration (minute)	0

- **Temperature Band:** Define the on/off hysteresis relative to temperature.
- **Humidity Band (%):** Define the on/off hysteresis relative to humidity.
- **Diff Between Cool Pads Stage:** Platinum Pro/Rotem Pro supports four cooling pad stages. The controller activates the first stage when the temperature reaches the Tunnel Temperature (*Control > Temperature Curve*) plus the Tunnel Differentiation (set in the Cool Pad screen). Each additional stage begins when the temperature reaches the Tunnel Temperature plus the Tunnel Differentiation plus this differentiation.

For example, if:

- Tunnel Temperature = 80°
- Tunnel Diff = 2
- Diff between Cool Pads Stage = 3

Stage 1 starts at 82°, Stage 2 at 85°, Stage 3 at 88°, and Stage 4 at 91°.

*Example: Cool Pad ON temperature = 80°, Diff set to 2° F:*

Cool Pad #	Assigned Sensor	Diff Between Cool Pads Stage	Actual ON temperature
1	Average	0.0	80°
2	Average	2.0	82°
3	Temp Sensor 2	0.0	80°
4	Temp Sensor 2	2.0	82°

- **Cool Pad Minimum Level:** In systems having more than one pump, this parameter enables keeping a cool pad inoperative until the associated tunnel curtain turns on. Define the minimum level for each cool pad.

**NOTE** When the Difference Between Cool Pads Stage is enabled, the cool pads operate according to both conditions.

#### Cool Pad Flush

- **Flush Cool Pad At:** Set time of day (hh:mm) to start continuous water application to remove deposits from the cool cells.

- **Cool Pad Flush Duration (minutes):** Set the length of time in minutes for flushing. If this parameter is set, flush is applied without regard to ventilation level or operating mode.

## 4.6.2 COOL PAD (RAMPING)

The following section describes the Cool Pad, Version 6.22 and above.

- Introduction to Cool Pad Ramping
- Cool Pad Main Screen
- Cool Pad Help | Set Definitions

### 4.6.2.1 Introduction to Cool Pad Ramping

➡ Define relays as cool pads. Refer to Relay Layout, page 139.

As an option, Version 6.22 supports Cool Pad Ramping. Please note that Version 6.22 also supports the non-ramping option.

Ramping means that the user defines under what climatic conditions cool pads change their working/non-working periods. The user defines the cool pads minimum and maximum off times. As the temperature changes, the controller automatically adjusts the off time. For example, if the temperature increases, the controller reduces the off time. The cool pad(s) continues to operate until the temperature decreases to a user defined point.

Additional pads begin to operate based on:

- the Cooling Differential which is the temperature difference required to activate additional cooling pads.
- the ventilation level at each cooling pad begins to operate.

The user sets the following parameters to configure ramping:

- On/Off temperatures.
- Ramping range is the temperature range (above the Cool Pad ON temperature) in which ramping takes place. If the temperature rises above the defined range, ramping ceases.
- The user defines the On time, which remains constant for each day and the minimum/maximum Off times. The controller then automatically adjusts the Off time as the temperature changes.
- You can specify the time frame during the day when cooling can take place.
- You can define how the humidity affects the cool pads.

*NOTE Incorporating humidity levels in the operating parameters requires installing a humidity sensor. Invalid sensor readings disable these conditions.*

### 4.6.2.2 Cool Pad Main Screen

➡ Define relays as cool pads. Refer to Relay Layout, page 139.

To configure Cool Pad Ramping:

1. Go to Control > Control Mode and enable Cooling Ramping.

CONTROL MODE	
Growing Zone	FULL HOUSE
House Mode	NORMAL
Temperature Curve	YES
Min. Max. Level Control	BY WEIGHT
Heat Cycle:	NO
Analog Heat Mode	LINEAR
THI Mode	NO
Cooling Ramping	YES

2. Go to Device > Cool Pad.

COOL PAD					
Day	On Temp Diff	Off Temp Diff	On Time	Max Off Time	Min Off Time
1	0.0	0.0	0	0	0
7	0.0	0.0	0	0	0
12	0.0	0.0	0	0	0
14	0.0	0.0	0	0	0
16	0.0	0.0	0	0	0
18	0.0	0.0	0	0	0
20	0.0	0.0	0	0	0
22	0.0	0.0	0	0	0
25	0.0	0.0	0	0	0
30	0.0	0.0	0	0	0

3. Define:

- **Day:** Defines the growth day at which the cooling function takes place. Only one line per day is valid. If more than one line defines the same day, the last line only defines the function.
- **On Temp Difference:** Set the difference from the tunnel temperature (defined in the Temperature Curve, page 19) at which cooling begins. Range: -36.0° to +36.0° F / -20° to +20° C. Default: 0
- **Off Temp Difference:** Set the difference from the tunnel temperature (defined in the Temperature Curve, page 19) at which cooling ceases. Range: -36.0° to -5.9° F / -20° to -3.3° C. Default: 0

*NOTE Each cooling pad operates according to its own temperature sensor (refer to Temperature Definition, page 148).*

- **On Time:** Define the operating time. Range: 0 – 999. Default: 0
- **Maximum Off Time:** Define the maximum amount of time that a cool remains off before restarting. Range: 0 – 999. Default: 0. Set the time to 0 for continuous operation.
- **Minimum Off Time:** Define the minimum amount of time that a cool remains off before restarting. Range: 0 – 999. Default: 0

4. Define the Set Definitions.

### 4.6.2.3 Cool Pad Help | Set Definitions

② While viewing the Cool Pad menu: Press **HELP**, select **SET** and press **ENTER**.

SYSTEM PARAMETERS	
COOL PAD	
Enable Cooling From Time	0:00
Enable Cooling To Time	0:00
Ramping Temperature Range	20.0
Humidity % to Stop Cooling	100
Off Humidity Band (%)	5
Diff Between Cool Pads Stage	2
Cool Pad-1 Min Level to Operate	1
Cool Pad-2 Min Level to Operate	1
Cool Pad-3 Min Level to Operate	1
Cool Pad-4 Min Level to Operate	1
Cool Pad-5 Min Level to Operate	1
Cool Pad-6 Min Level to Operate	1
COOL PAD FLUSH	
Flush Cool Pad At:	0:00
Cool Pad Flush Duration (minute)	0

- Define:
  - **Enable Cooling From/To Time:** Define the hours between which cooling pads can operate. Range: 00:00 – 23:59. Default: 00:00 (always enabled)
  - **Ramping Temperature Range:** Define the maximum temperature at which ramping takes place. Ramping takes place between the On Temperature (+ 0.5°) and this point. For example if cooling begins at 75° and the ramping range is 10°, ramping continues until the temperature reaches 85.5°. Range: 0 – 36° F/0 – 20° C. Default: 36°/20°.
  - **Humidity % to Stop Cooling:** Above this level, cooling ceases. Range 0 – 100%. Default: 100%.

**NOTE** As cool pads operate, the humidity can rise to the level that causes cool pads to stop operating.

- **Off Humidity Band:** Define the drop in humidity that must occur before cooling restarts (after cooling ceases because of high humidity). Range: 0 – 20%. Default: 5%
- **Diff Between Cool Pads Stage:** Define the temperature differential required for the next cool pad to begin operating. Range: 0 – 36° F/0 – 20° C
- **Cool Pad 1 – 6 Minimum Level to Operate:** Define the ventilation level for each cool pad. Range: 0 – 30. Default: 1

#### Cool Pad Flush

- **Flush Cool Pad At:** Set time of day (hh:mm) to start continuous water application to remove deposits from the cool cells. If flushing occurs during a ramping cycle, the cool pad operates continually until flushing ceases; at the point ramping restarts.
- **Cool Pad Flush Duration (minutes):** Set the length of time in minutes for flushing. If this parameter is set, flush is applied without regard to ventilation level or operating mode.



## 4.7 Foggers

### 4.7.1 FOGGERS MAIN SCREEN

This menu sets the Foggers operating conditions.

- Foggers and Cool Pad have different temperature reference points. The Fogger Temperature Differentials are relative to the target temperature; the Cool Pad is relative to the tunnel entry temperature.
- Foggers operate even when the controller is not in tunnel mode.

FOGGERS						
Day	Start Time	End Time	Target Diff	To Hum	On sec	Off sec
47	12:00	21:00	18.0	99	300	600
47	12:00	21:00	20.0	99	300	300
0	00:00	00:00	0.0	0	0	0
0	00:00	00:00	0.0	0	0	0
0	00:00	00:00	0.0	0	0	0
0	00:00	00:00	0.0	0	0	0
0	00:00	00:00	0.0	0	0	0
0	00:00	00:00	0.0	0	0	0
0	00:00	00:00	0.0	0	0	0
0	00:00	00:00	0.0	0	0	0
0	00:00	00:00	0.0	0	0	0

- **Day:** Set growth day.
- **Start Time & End Time:** Time of day you want foggers to start and stop.
  - It is possible to set multiple start and stop times for a single day.
  - In the screen above, the first programmed line is at day 47. The foggers do not operate before growth day 47 in this case. Since there are no entries other than day 47, the day 47 program lines apply from then on.
- **Target Differential:** Set difference from target temperature to trigger foggers.
- **To Humidity:** Set maximum humidity allowed before stopping foggers.
- **On Sec:** Set the maximum on time for each cycle of fogger operation.
- **Off Sec:** Set the minimum off time for each cycle of fogger operation.

### 4.7.2 FOGGERS HELP | SET DEFINITIONS

① While viewing the Foggers menu: Press **HELP**, select **SET** and press **ENTER**.

SYSTEM PARAMETERS	
FOGGERS	
Temperature Band	2.0
Humidity Band (%)	2.0
Min Level to Enable Operation	1
Max Level to Enable Operation	30
Enable Rotation	NO
Difference between Foggers Stage	0.0

- **Temperature Band:** Define the on/off hysteresis relative to temperature.
- **Humidity Band (%):** Define the on/off hysteresis relative to humidity.
- **Min Level to Enable Operation:** Select the minimum ventilation level to operate the foggers.

- **Max Level to Enable Operation:** Set the maximum ventilation level for fogger operation.
- **Enable Rotation:** Enable this function to use a different fogger relay each cycle. This function enables dispersing the droplets at a higher pressure, to wet the animal.

*NOTE Munters recommends keeping this function set at the default setting (No).*

- **Difference between Foggers Stage:** Platinum Pro/Rotem Pro supports four fogging stages. The controller activates the first stage when the temperature reaches the Target Temperature (Control > Temperature Curve) plus the foggers' differential. Each additional stage begins when the temperature reaches the Target Temperature plus the fogger differentiation.

For example, if:

- Foggers Target Temperature = 80°
  - Diff between Foggers Stage = 3
- Stage 1 starts at 83°, Stage 2 at 86°, Stage 3 at 89°, and Stage 4 at 92°.

## 4.8 Light

This menu sets the lights operating conditions. The controller has a capacity for up to four channels of *On/Off Lights* and up to 10 channels of *Dimmer Lights*. In addition, this menu enables using a light sensor.

### 4.8.1 CONFIGURING THE LIGHTS

1. In *Install > Relay Layout* (refer to Relay Layout, page 139) or *Analog Output* (refer to Analog Output, page 143) define up to 10 outputs as light dimmers.
2. In *Device Setting > Light*, define the parameters as required.

LIGHT						
Day	Time	Light			Intensity (%)	
		1	2	3	1	2
1	00:00	✓	✓	■	100	0
12	00:00	✓	■	✓	45	45
12	01:00	■	■	■	0	0
12	03:00	✓	■	✓	45	45
12	21:00	■	■	■	0	0
25	00:00	■	■	■	0	0
25	03:00	■	■	■	35	35
25	20:00	■	■	■	0	0
25	23:00	■	■	■	35	35
0	00:00	■	■	■	0	0

*NOTE Intensity appears if an analog output is defined as a light dimmer.*

Water & Feed (page 70) configuration defines the Light Menu configuration:

- If you select Daily, the above screen appears when you select Light; configure the Light menu once.
- If you select 2 – 6 Days or Week, the screen below appears.



1. Select Feed and press Enter. The Light parameters screen appears. These parameters configure the Light functions on feed days.
2. Configure the parameters.
3. Select No Feed and press Enter. The Light parameters screen appears. These parameters configure the Light functions on non-feed days.
4. Configure the parameters.

- **Day:** Set Growth Day

In the example, the brood lights (channel 1) and bright center lights (channel 2) turn on from day 1, while the grow end lights (channel 3) are off. The example shows two channels of light dimmer, Channel 1 at 100% and Channel 2 at 0% (for baby chicks in the brood zone).

- **Time:** Set event times for the lights.
  - On day 12, the center lights turn off, and the dimmer lights go to 45%. There are two periods of darkness: from 01:00 to 03:00 in the morning, and 09:00 PM to midnight. This program repeats until day 25.
  - From day 25 the on/off lights stay off, and the dimmer lights provide dim light during the on periods and go out fully for two periods of darkness. The dark periods total 6 hours, being from midnight to 03:00 AM and from 08:00 PM (20:00) to 11:00 PM (23:00).
- **Light:** Check mark the desired light(s) to turn on. Apply dots for lights you would like to turn off. Switch between check marks and dots by pressing the +/- key.
- **Intensity (%):** Set intensity in percentage for light dimmer(s). Dimmer lights start to brighten if the intensity increases, and complete dimming if the intensity decreases at the set time. That is, they start dimming the 'sunset time' in advance of the set time (see Help | Set below).

#### 4.8.2 LIGHT HELP | SET DEFINITIONS

*NOTE Pig mode does not support the Light Help parameters.*

- ② *While viewing the Light menu: Press HELP, select SET and press ENTER.*

DEVICE SETTING	
LIGHT	
Sunrise Time (minutes)	10
Sunset Time (minutes)	10
Allow Spiking from Day	1
Spike Cycle (minutes)	0
Spike Duration (minutes)	0
Spike Increase Amount (%)	0
Signal Light Is:	LIGHT2
Signal Before Feed (seconds)	60
Signal During Feed (seconds)	60
Light Sensor Active	NO

- **Sunrise Time (minutes):** The amount of time required for the light intensity to rise from 0% to the designated level.
- **Sunset Time (minutes):** The amount of time required for the light intensity to decline from the designated level to 0%.
- **Allow Spiking from Day:** The day spiking begins.
- **Spike Cycle (minutes):** The time length that the spike is at its maximum level. Reaching the maximum level and returning to the preset level both take one minute. For example if the spike duration is 10 minutes, the spike cycle is 8 minutes.
- **Spike Durations (minutes):** The total amount of time of the spike cycle, including the rise and fall times.
- **Spike Increase Amount:** Set the increase in intensity for the spike in relation to the current light intensity.
- **Signal Light Is:** Only one light operates during feeding times. Select which light is lit or choose "None".

*NOTE After the feeding period ends, all lights selected in the Light Parameters screen relight.*

- **Signal Before Feed (seconds):** Amount of time before the feeding starts, that all other lights go off.
- **Signal During Feed (seconds):** Amount of time that the selected light remains on after feeding ends.

*NOTE The above two parameters are disabled on no feed days.*

- **Light Sensor Active:** The light sensor turns off all lights when sufficient outside light exists. If a light sensor is installed, enable this option to turn off the light during feeding time when there is sufficient outside light. Refer to Light Sensor Calibration, page 125 for details.

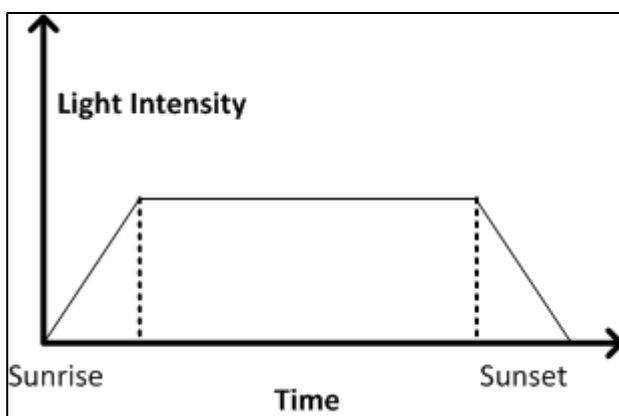

*Figure 3: Lighting without Spiking*

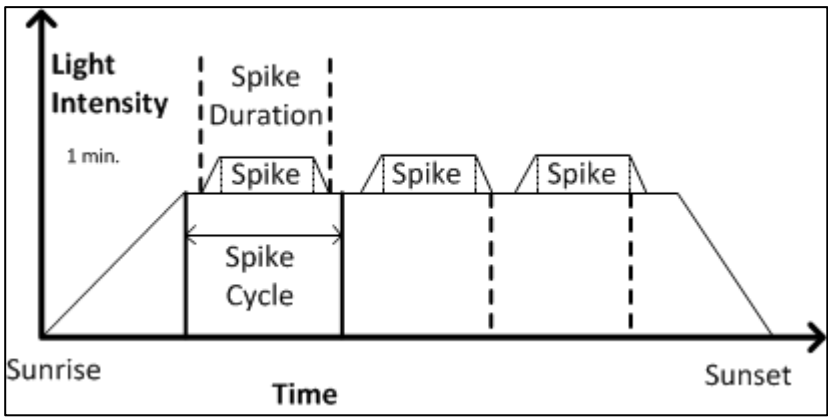

Figure 4: Lighting with Spiking

NOTE The initial reference time for the Spike Cycle is the end of Sunrise. The spike begins Spike Duration minutes before the end of the Spike Cycle and has one minute up and down ramps in intensity. If Sunrise Duration is set to zero, no spiking occurs.

### 4.8.3 LIGHT MEASUREMENT CONTROL

Version 6.20 supports employing a LUX light sensor to control the light intensity. In this function, the Target LUX is the defined light intensity target. The controller measures the light intensity in LUX values and adjusts the output accordingly.

- On/OFF Light Function does not operate when using Light Dimming by LUX.
- Sunrise/Sunset functions do not operate when using Light Dimming by LUX.

To configure light measurement:

1. In Install > Analog sensor, define a sensor as Light 0 – 40 LUX.
2. Go to Device > Light. Target LUX only appears if a sensor is defined.

LIGHT				
Day	Time	Target LUX	Light 1	Light 2 3
1	00:00	50	✓	✓ ■
12	00:00	40	✓	■ ✓
12	01:00	40	■	■ ■
12	03:00	50	✓	■ ✓
12	21:00	50	■	■ ■
25	00:00	40	■	■ ■
25	03:00	40	■	■ ■
25	20:00	50	■	■ ■
25	23:00	0	■	■ ■
0	00:00	0	■	■ ■

3. Define the target.
4. Go to Device > Light > Settings.
5. Define:
  - LUX Band (LUX): No change in light output takes place while the measured amount of light is within this band (percentage). Default 2. Range 2 – 10.
  - Increase Interval Time (sec): The interval time for the light intensity to increase (by 1%) from the previous change. Default. Range 0 – 120.
  - Decrease Interval Time (sec): The interval time for the light intensity to decrease (by 1%) from the previous change. Default. Range 0 – 120.

6. Set the Low Light Alarm Enabled alarm, page 96 (optional).

## 4.9 Water & Feed

This menu sets the operating conditions for water and feed devices.

- Control via Time
- Control via Quantity
- Control by Feed Counter
- Water and Feed Help | Set Definitions

### 4.9.1 CONTROL VIA TIME

WATER & FEED							
Day	Time hh:mm	Water		Feeder		Auger	
		1	2	1	2	1	2
1	00:00	✓	▪	✓	▪	✓	▪
12	10:00	✓	✓	✓	✓	✓	▪
25	14:00	✓	✓	✓	✓	▪	✓
46	00:00	✓	✓	▪	▪	▪	▪
48	00:00	▪	▪	▪	▪	▪	▪
0	00:00	▪	▪	▪	▪	▪	▪
0	00:00	▪	▪	▪	▪	▪	▪
0	00:00	▪	▪	▪	▪	▪	▪
0	00:00	▪	▪	▪	▪	▪	▪
0	00:00	▪	▪	▪	▪	▪	▪
0	00:00	▪	▪	▪	▪	▪	▪

1. In *Install > Relay Layout* (page 139), define 1 - 4 relays as an auger (plus any required feed and water lines).

2. In *Device Settings > Water & Feed > Help Settings*, disable **Feed by Quantity**.

3. In *Device > Water and Feed*, define the parameters as required.

- **Day:** Set growth day. You can define days as negative days. Enter the number and then press the +/-key.
- **Time:** Set event times for water, feeder, or auger. Check marks indicate ON at the event time, and dots indicate OFF. Toggle between check marks and dots with the +/- keys.

**NOTE** In *Layers Mode*, the time format is *hh:mm:ss* (in *Control by Time* only).

- **Water:** Select a check mark to mark water lines to turn on, dot the ones to turn off.
- **Feeder:** Check mark feed lines to turn on, dot the ones to turn off.
- **Auger:** Check mark auger lines to turn on, dot the ones to turn off.

4. Set the Water Overflow Alarms and Water Shortage Alarms.

**NOTE:** You can implement mealtime, clean up meals and other options similarly as shown earlier in the light programs.

## 4.9.2 CONTROL VIA QUANTITY

1. In *Install > Relay Layout* (page 139), define 1 - 4 relays as an auger (plus any required feed and water lines).
2. In *Scale Menu > Scale Layout* (page 103), map each silo to a channel.
3. In *Device Settings > Water & Feed > Help Settings*, enable **Feed by Quantity**.
4. In *Device > Water and Feed*, define the parameters as required.
5. Set the Water Overflow Alarms and Water Shortage Alarms.

WATER & FEED										
Day	From Time	To Time	Water		Feeder		Feed			
			1	2	1	2	1	2	3	4
1	00:00	00:30	✓	▪	✓	▪	50	75	0	0
12	10:00	10:30	✓	✓	✓	✓	75	100	0	0
25	14:00	14:30	✓	✓	✓	✓	100	200	0	0
32	14:00	15:00	✓	✓	▪	▪	100	200	0	0
40	14:00	15:30	▪	▪	▪	▪	100	250	0	0
0	00:00	00:00	▪	▪	▪	▪	0	0	0	0
0	00:00	00:00	▪	▪	▪	▪	0	0	0	0
0	00:00	00:00	▪	▪	▪	▪	0	0	0	0
0	00:00	00:00	▪	▪	▪	▪	0	0	0	0
0	00:00	00:00	▪	▪	▪	▪	0	0	0	0

- **Day:** Set growth day. You can define days as negative days. Enter the number and then press the +/-key. Growth days stay at the defined parameters until the next defined day.
- **From Time/To Time:** Set the time period during which water, feeder, and feeding lines can operate.
- **Water:** Select a check mark to mark water lines to turn on, dot the ones to turn off.
- **Feeder:** Check mark feed lines to turn on, dot the ones to turn off.
- **Feed:** Enter the quantity of feed provided from the silos during the From/To time.
  - You can provide feed from multiple silos, enabling specific feed mixes.
  - Distribution continues until the To Time or until the defined quantity is reached, whichever comes first.
  - If a relay is not defined as an auger the Feed numbers still appear. However any quantity entered is meaningless.

Water runs continually between the From/To times. Only feed is distributed in cycles.

**NOTE:** *This function only works when relays are defined as augers and each silo is mapped to an auger. Defining a digital sensor as a feed count does not enable Control by Quantity.*

**NOTE:** *If both Control via Quantity and a digital feed counter are enabled, Control via Quantity takes priority.*

## 4.9.3 CONTROL BY FEED COUNTER

Control by Feed Counter (Version 6.19 and higher) enables measuring the amount of feed distributed via the digital sensors. These sensors record each time the feeding equipment delivers a (fixed) quantity of feed. By measuring the number of feed pulses, the controller can record the quantity (weight) of feed delivered.

- When using this method there is no need to define silos.

- The user must know how much feed is delivered by the feed equipment.
1. In *Install > Relay Layout* (page 139), define 1 - 4 relays as an auger (plus any required feed and water lines).
  2. In *Install > Digital Sensors*, define the required number of digital sensors as **Feed Count**.
  3. In *Device Settings > Water & Feed > Help Settings*, select **Count**.

SYSTEM PARAMETERS	
<b>WATER &amp; FEED</b>	DAILY COUNT
Feed Day Cycle Feed by Quantity	

4. In *Device > Water and Feed*, define the parameters as required.
5. In *Service > Feed Calibration*:
  - Define the Method as **Pulse**
  - In **Factor**, enter the weight of each delivery.
6. Set the **Water Overflow Alarms** and **Water Shortage Alarms**.

WATER & FEED										
Day	From Time	To Time	Water		Feeder		Feed			
			1	2	1	2	1	2	3	4
1	00:00	00:30	✓	▪	✓	▪	50	75	0	0
12	10:00	10:30	✓	✓	✓	✓	75	100	0	0
25	14:00	14:30	✓	✓	✓	✓	100	200	0	0
32	14:00	15:00	✓	✓	▪	▪	100	200	0	0
40	14:00	15:30	▪	▪	▪	▪	100	250	0	0
0	00:00	00:00	▪	▪	▪	▪	0	0	0	0
0	00:00	00:00	▪	▪	▪	▪	0	0	0	0
0	00:00	00:00	▪	▪	▪	▪	0	0	0	0
0	00:00	00:00	▪	▪	▪	▪	0	0	0	0
0	00:00	00:00	▪	▪	▪	▪	0	0	0	0

- **Day**: Set growth day. You can define days as negative days. Enter the number and then press the +/-key. Growth days stay at the defined parameters until the next defined day.
- **From Time/To Time**: Set the time period during which water, feeder, and feed lines can operate.
- **Water**: Select a check mark to mark water lines to turn on, dot the ones to turn off.
- **Feeder**: Check mark feed lines to turn on, dot the ones to turn off.
- **Feed**: Enter the quantity of feed provided from the silos during the From/To time.
  - You can provide feed from multiple silos, enabling specific feed mixes. Each auger delivers feed from the silo having the same number; meaning Auger 1 receives feed from Silo 1 and so on.
  - Distribution continues until the To Time or until the defined quantity is reached, whichever comes first.
  - If a relay is not defined as an auger the Feed numbers still appear. However any quantity entered is meaningless.

**NOTE:** *This function only works when relays are defined as augers.*



#### 4.9.4 WATER AND FEED HELP | SET DEFINITIONS

These parameters define the feed and water delivery schedule through the week.

**NOTE:** *The Water and Feed parameters work in conjunction with the Lighting parameters.*

- **Feed Day Cycle:**
  - **Daily:** Same schedule for every day of the week.
  - **2 – 6 Days:** Select a cycle that lasts the number of days chosen and then repeats itself. For example, 2 Days means that the cycle lasts two days and then repeats itself.

SYSTEM PARAMETERS			
<b>WATER &amp; FEED</b>			
Feed Day Cycle	3 Day		
Feed by Quantity	YES		
<b>DAYS CYCLE</b>			
Day:	1	2	
Feed:	✓		
<b>WATER ON NO FEED DAYS</b>			
Start	Stop	Start	Stop

- **Week:** Select which days in the week that feed and water are delivered.

SYSTEM PARAMETERS							
<b>WATER &amp; FEEDS</b>							WEEK
Feed Day Cycle							
<b>DAYS CYCLE</b>							
Day:	SUN	MON	TUE	WED	THU	FRI	SAT
Feed:	✓		✓	✓		✓	
<b>WATER ON NO FEED DAYS</b>							
Start	Stop	Start	Stop	Start	Stop	Start	Stop
10:00	10:30	11:30		12:30			

- **Quantity:** Enable this feature to enable Control by Quantity.

**NOTE:** *If you choose Daily, the Scale function is always enabled. If you choose 2- 6 Days or Week, the Scale function is disabled on non-feeding days.*

**CAUTION** *If you want to provide feed every day, select Daily. Selecting Week and marking each day causes problems with this function.*

If you select the 2 – 6 Day schedule or the Week schedule, configure:

- **Days Cycle (2 – 6 Days):** Select which days in the cycle that feed and water is delivered.
- **Week Cycle:** Select the days that feed and water is delivered.
- **Water on No Feed Days:** Select up to two time periods when water is delivered on non-feed days.

**NOTE:** *On feed days, water is delivered when feed is delivered.*

## 4.10 Extra Systems

This menu sets the parameters of other devices that are not listed in the controller.

EXTRA SYSTEMS				
System	1	2	3	4
Start Time	10:30	06:15	14:20	00:00
End Time	18:45	20:30	03:15	00:00
From Temp	75.5	85.5	60	0.0
To Temp	93.0	95.5	98.0	0.0
From Hum.	55	60	60	0
To Hum.	85	85	85	0
On (sec)	45	45	300	0
Off (sec)	300	300	2000	0

- **Start Time:** Time at which this Extra System starts.
- **End Time:** Time at which this Extra System stops.
- **From Temp:** Temperature above which Extra System operates.
- **To Temp:** Temperature below which Extra System operates.
- **From Humidity:** Humidity above which Extra System operates.
- **To Humidity:** Humidity below which Extra System operates.
- **On (sec):** On time for the Extra System. If set to 0, the extra system does not operate.
- **Off (sec):** Off time for Extra System after completion of on time. If you have values in both ON and Off, the extra system cycles. If you have zero OFF time, and any ON time, the system simply stays on as long as the other parameters are satisfied.

*NOTE All parameters must be satisfied for an Extra System to operate. For example if the temperature is below the From Temperature or the Humidity below the From Humidity, the system is OFF. You can assign specific temperature sensors to an Extra System in [Install Temp Definition](#). The Extra System uses the Inside Humidity, not the Outside Humidity. If there is no humidity sensor, the Extra Systems ignore the humidity parameters.*

## 4.11 Water on Demand

The Water on Demand (WOD) function enables regulating the pressure of all nipple lines in the house from one central point, ensuring uniform pressure in all lines. The function also enables immediate transitioning between different preset pressures of all nipple lines in the house by closing and opening of valves at the central point (manual or solenoid according to the mode installed).

Platinum Pro/Rotem Pro enables controlling the water cycle times using relays and controlling the water pressure using analog input and output sensors. The two methods are complimentary. A user can use either one alone or both.

- Relay Control
- Sensor Control
- Water on Demand Help | Set Definitions

*NOTE The two methods are complimentary.*

### 4.11.1 RELAY CONTROL

Specify up to 50 time periods.

WATER ON DEMAND					
Day	Time hh:mm	WOD-RLY			
		1	2	3	4
1	12:00	✓	●	✓	●
2	6:00	✓	✓	✓	●
3	8:00	✓	✓	✓	●
5	10:00	✓	✓	✓	●
7	12:00	✓	●	✓	●
9	14:00	✓	●	✓	●

1. In *Installation* > *Relay Layout* designate up to four relays as WOD valves.
2. In *Device* > *Water on Demand*, configure the following parameters:
  - Day: Specifies the day to activate the selected WOD valve. You can define days as negative days. Enter the number and then press the +/-key.
  - Time: Specifies the time to activate the enabled valves. The valves continue running until the next scheduled day and time.
  - WOD Relay: Enable the required relays.
3. Set the Water on Demand Alarms.

### 4.11.2 SENSOR CONTROL

**NOTE** When using sensor control, WOD status appears on the Main Screen, Hot Screen 7, and Hot Screen 0.

WATER ON DEMAND						
Day	Time hh:mm	WOD-RLY				Press IN. W.C
		1	2	3	4	
1	12:00	✓	●	✓	●	30.00
1	16:00	✓	✓	✓	●	20.00
3	8:00	✓	✓	✓	●	15.00
5	10:00	✓	✓	✓	●	10.00
7	12:00	✓	●	✓	●	10.00
9	14:00	✓	●	✓	●	5.00

To add precision measurements:

1. To control the water valve opening, in *Installation* > *Analog Output*:
  - a. designate one output device as Water on Demand Precision.
  - b. set the minimum input and output voltages.
2. In *Installation* > *Analog Sensor*, designate one sensor as Water of Demand Pre. This setting enables a sensor to measure the water flow.
3. In *Device* > *Water on Demand*, configure the following parameters:
  - Day: Specifies the day to activate the selected WOD valve. You can define days as negative days. Enter the number and then press the +/-key.
  - Time: Specifies the time to activate the enabled valves. The valves continue running until the next scheduled day and time.
  - WOD Relay: Enable the required relays.

- **Pressure:** Specifies the required water pressure. The unit that appears is the unit defined in *Installation > Setup* (pressure unit).

4. In *Device > Water on Demand > Help* set the parameters (optional).

5. In *Service > WOD Calibration:*

- Enter the first pressure and voltage data points.
- Repeat for second data point.
- Set the Help definitions (optional).

6. Set the Water on Demand Alarms.

### 4.11.3 WATER ON DEMAND HELP | SET DEFINITIONS

SYSTEM PARAMETERS	
WATER ON DEMAND – NIPPLE FLUSH	
Water Pres. During Flush:	0
Relay Active During Flush:	0

- **Water Pressure During Flush:** Designate the system water pressure when nipple flush is operative.
- **Relay Active During Flush:** Designate which WOD relays remain active during flushing.

## 4.12 Natural Program

The Natural Program enables supplying the house's air requirements using the wind. Using the Natural Program depends on a variety of environmental and scheduling factors. While in this mode, curtains open and close based on the target temperature.

Setting up the Natural Ventilation is a multistep process.

- How Does Natural Ventilation Work
- Preliminary Steps
- Defining Natural Conditions
- Defining Natural Operation
- Natural Programming Help | Set Definitions
- Natural Program Hot Screen
- What Happens When the Controller Transitions?

NATURAL PROGRAM	
<b>NATURAL CONDITIONS</b>	
From Day	1
To Day	50
From Time	0:00
To Time	0:00
Low Out Temp Target Diff	-10.0
High Out Temp Target Diff	5.0
Min Wind Speed to Enter	2.0
Max Wind Speed to Exit	10.0
<b>NATURAL OPERATION</b>	
Low Temp Diff (Curt Min Pos)	1.0
High Temp Diff (Curt Max Pos)	6.0
Step size	10
Stage Delay (sec)	300
Min Curtain Position	15
Max Curtain Position	100
Wind and Rain Effect	YES

#### 4.12.1 HOW DOES NATURAL VENTILATION WORK

For the controller to switch to Natural Ventilation:

- Natural Ventilation works only during the defined growth days and daily schedule.
- The temperature inside the chicken house must be within the inside temperature band.
- The temperature outside the chicken house must be within the outside temperature band.
  - If the temperature is below either of the above two parameters, ventilation switches to Minimum.
  - If the temperature is above either of the above two parameters, ventilation switches to Tunnel (there is an option to remain in natural ventilation; refer to Minimum Wind Speed for Tunnel Temp).
- The wind speed must be within the wind speed band.
- The wind direction must be within the user-defined area.

*NOTE Including the wind speed and direction in Natural Ventilation calculations is optional and requires in the installation and configuration of additional equipment.*

- If the weather conditions meet the above requirements, curtains open to a calculated position based on the difference temperature and minimum and maximum percentage. If more air is required, the curtains adjust themselves automatically using a calculation based on the minimum and maximum curtain position. The larger the difference between the minimum and maximum openings, the larger the step.
- Any change in the curtain position takes place after the Delay Time.

#### 4.12.2 PRELIMINARY STEPS

- Install a wind speed and rain detector (optional).
- Install a wind direction sensor (optional).

1. In *Installation > Setup > Natural Ventilation*, select:

- **Program:** This option uses the parameters listed below to determine curtain opening.

- **Level:** This option instructs the controller to run Natural Ventilation using the levels shown in *Device Settings > Vent and Curtain Levels*. If you choose this option, no further setup is required.
2. If you installed a wind speed and rain detector, in *Installation > Digital Sensors*, define the sensors accordingly.
  3. If required, in *Installation > Temperature Definition* designate a temperature sensor as an outside sensor.
  4. If you installed a wind direction sensor:
    - a. In *Installation > Analog Sensor*, define the sensor accordingly.
    - b. If required, calibrate the wind direction sensor.
  - **Version 6.18:** In *Installation > Vent/Curtain Setup*, define each curtain's direction. When making Natural Program calculations, the controller only takes into consideration winds coming from a certain direction. Any wind whose source is outside of this area is disregarded.

The number entered here defines the area (the number entered  $\pm 90^\circ$ ) (Figure 5).

- If you enter 90, the range is from 0 - 180°
- If you enter 45, the range is from 315 - 135°

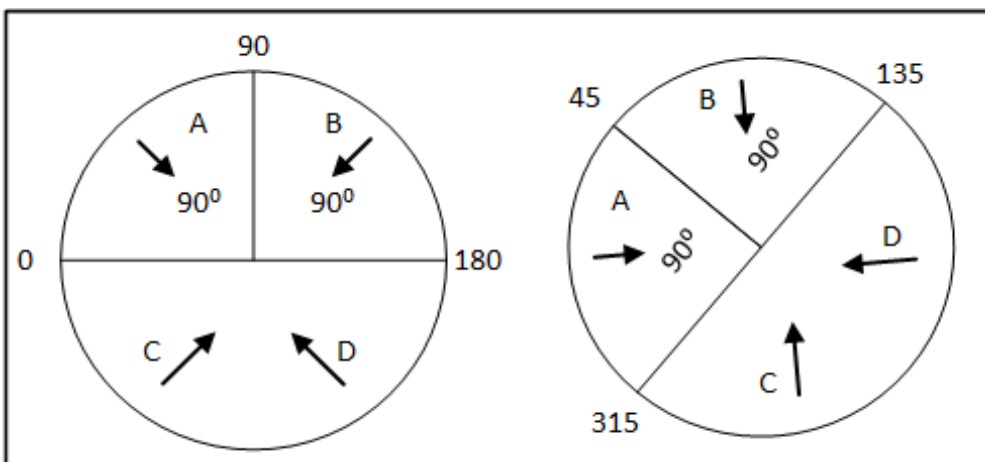

Figure 5: Wind Direction Sensor Definition, Version 6.18

**CAUTION** In both cases, winds A or B would be factored into the calculations whereas winds C or D would not. Only calibrate the sensors if you have reason to believe that they are producing inaccurate results.

The number entered here defines the area on both sides of the sensor! Figure 5 illustrates a chicken house with four wind sensors. Sensor 1's Wind Direction parameter is defined as 45° or 90° total. Winds that come within this area (A) are used for Natural Programming. The controller disregards winds outside of this area (B & C).

- **Version 6.19:** In *Installation > Vent/Curtain Setup*, define each curtain's direction. When making Natural Program calculations, the controller only takes into consideration winds coming from a certain direction. Any wind whose source is outside of this area is disregarded.

The number entered here defines the area (the number entered  $\pm 20^\circ$ ) (Figure 6).

- If you enter 90, the range is from 20 - 160°
- If you enter 45, the range is from 335 - 115°

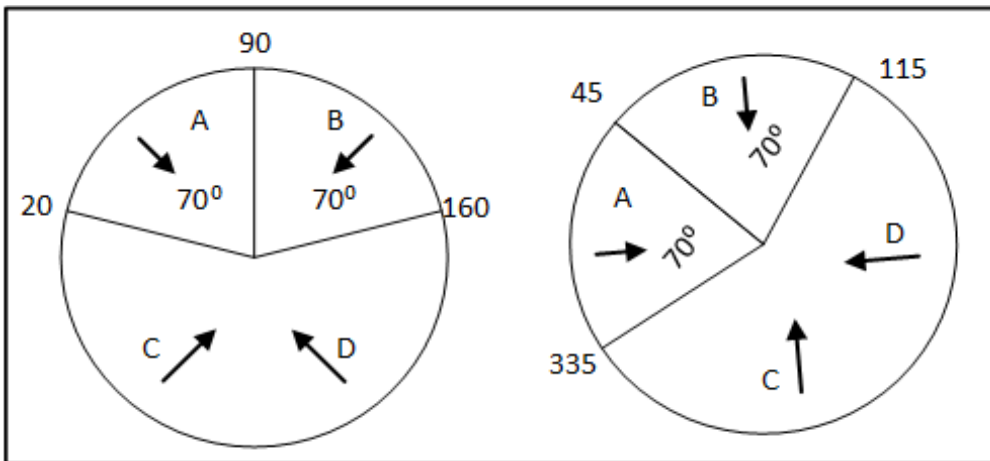

Figure 6: Wind Direction Sensor Definition, Version 6.19

#### 4.12.3 DEFINING NATURAL CONDITIONS

Natural Conditions define when the controller switches to Natural Ventilation. Set the following parameters:

- **From/To Day:** Sets start and end day for the Natural Program.
- **From/To Time:** Sets starting and finishing time for the Natural Program.
- **Low Outside Temperature Target Difference:** The band below the Current Target Temperature in which Natural Programming operates (outside temperature). Range: -20 to +20° C.
- **High Outside Temperature Target Difference:** The band above the Current Target Temperature in which Natural Programming operates (outside temperature). Range: -20 to +20° C.
- **Minimum Wind Speed to Enter:** Sets the wind speed required to enter Natural Program.
- **Maximum Wind Speed to Exit:** Sets wind speed required to exit Natural Program.
- **Minimum Wind Speed for Tunnel Temp:** When the unit is in Natural Mode, if the temperature rises above the Tunnel Temperature, the controller switches to Tunnel mode unless the wind speed is above the speed set here.

*NOTE* The above three parameters require installing and configuring a wind speed sensor.

#### 4.12.4 DEFINING NATURAL OPERATION

- Defining Natural Operation / No Minimum Curtain Opening Curve
- Defining Natural Operation / Minimum Curtain Opening Curve Enable

##### 4.12.4.1 Defining Natural Operation / No Minimum Curtain Opening Curve

Natural Operation defines how the controller functions in Natural Ventilation.

- **Low Temperature Difference:** The band below the Current Target Temperature in which Natural Programming operates (inside temperature).
- **High Temperature Difference:** The band above the Current Target Temperature in which Natural Programming operates (inside temperature)
- **Step size (%):** Sets each levels step increment.
- **Curtain delay time:** To prevent excess switching between steps, set a delay time.

- Minimum Curtain Position: Sets the minimum curtain position.
- Maximum Curtain Position: Sets the maximum curtain position.
- Wind and Rain Effect: Enables Platinum Pro to consider additional parameters (found in the Help) when calculating the maximal curtain opening.

#### 4.12.4.2 Defining Natural Operation / Minimum Curtain Opening Curve Enable

Version 6.19 enables defining a curve for the minimum curtain opening.

- Under Natural Operation, define the:
  - Min Curtain Position (1st Day): Set the minimum curtain position on first growth day.
  - Min Curtain Position (Last Day): Set the minimum curtain position on last growth day.

The differential between these parameters defines the curve that sets the minimum curtain position for each day.

NATURAL PROGRAM	
NATURAL OPERATION	
Low Temp Diff (Curt Min Pos)	1.0
High Temp Diff (Curt Max Pos)	6.0
Step size	10
Stage Delay (sec)	300
Min Curtain Position (1st Day)	15
Min Curtain Position (Last Day)	55
Max Curtain Position	100
Wind and Rain Effect	YES

#### 4.12.5 NATURAL PROGRAMMING HELP | SET DEFINITIONS

SYSTEM PARAMETERS	
NATURAL SETTING	
Enable Natural In Tunnel	NO
Wind Gust delay Time (sec)	60
Disable Stir Fan above W. Speed	6
Minimum Time in Any Vent Mode	10
Use Tunnel as Natural Curtain	NO
WIND & RAIN EFFECT	
Wind Low speed	4
Wind High speed	8
Wind & Rain Low speed	2
Wind & Rain High speed	6

- Natural Setting
  - Enable Natural In Tunnel: Enables using Natural Ventilation definitions when in Tunnel mode.
  - Wind Gust delay Time (sec): Set the delay time for recalculating curtain movement if the wind speed changes.
  - Disable Stir Fan above Wind Speed: Above this speed, Stir Fans cease to operate when in Natural Programming.
  - Minimum Time in Any Vent Mode: Minimal amount of time that the controller waits before changing into Natural Programming (from Minimum Ventilation



or Tunnel Mode). Similarly, the controller remains in Natural Ventilation for at least this time.

- Use Tunnel in Natural Curtain: Use tunnel curtains when in Natural Programming. When disabled, curtains remain closed.
- Wind & Rain Effect
  - Wind Low speed: Below this speed, curtains open completely. This number must be higher than the Minimum Wind Speed to Enter.
  - Wind High speed: Above this wind speed, the controller lowers the curtain maximum opening percentage to this point.
  - Between these levels, the controller opens the curtain based on a curve.
  - Wind & Rain Low speed
  - Wind & Rain High speed

#### 4.12.6 NATURAL PROGRAM HOT SCREEN

When the Main Screen is displayed, press 5 to view the Natural Program Hot Screen. The Hot Screen display depends on the Natural Program Status.

- Ventilation is Not in Natural Mode
- Ventilation is in Natural Mode

##### 4.12.6.1 Ventilation is Not in Natural Mode

When the controller is employing Minimum or Tunnel Ventilation, the Hot Screen displays the conditions needed to enter Natural Mode.

*NOTE The Between Temp parameters can change based on the wind speed. Refer to Minimum Wind Speed for Tunnel Temp, page 79.*

NOT IN NATURAL MODE	
Wind Speed	Targ Temp
Wind Dir	Rain
Out Temp	Humidity In
Avg. Temp	Humidity Out
NATURAL MODE ENABLE CONDITIONS	
Between Growth Days	1 - 50
Time Frame	24 hrs
Between Inside Temp	79.0 – 91.0
Between Outside Temp	62.0 – 89.0
Between Wind Speed	11.2 – 22.4

##### 4.12.6.2 Ventilation is in Natural Mode

When ventilation is in Natural Mode, this screen displays the Natural Operation parameters.

*NOTE If the Tunnel Curtains are used as Natural Curtains, display the tunnel's state by pressing 5 while the Natural Hot Screen is displayed.*

NATURAL MODE - ACTIVE	
	Curt 1
Average Temp	78
Current Pos	100%
Next Step (sec)	0
Step Open Tmp	79
Step Open Pos	100%
Step Close Tmp	75
Step Close Pos	90%
Min Curt Pos	15%
Max Curt Pos	100%
Wind Influence	NO

*NOTE Step Temp and Step Pos are calculations, not parameters. They display when the conditions under which Natural Mode changes its settings.*

#### 4.12.7 WHAT HAPPENS WHEN THE CONTROLLER TRANSITIONS?

When the controller transitions to or from Natural Ventilation the following changes take place

- **Side/Power > Natural:** Fans stop, curtains open to the calculated position and finally the side inlets close.
- **Tunnel > Natural:** Fans stop, curtains open to the calculated position. When the curtains reach their maximum opening position, the tunnel closes (unless the tunnel mode operates to open in natural Mode).
- **Natural > Side/Power:** The controller automatically calculates most suitable Power Ventilation Level, depending on the Target Temperature and current Inside Temperature
- **Natural > Tunnel:** The controller automatically calculates the most suitable ventilation level depending on the Target Temperature and current Inside Temperature (minimum or tunnel).

#### 4.13 Feed Scale Program

*NOTE Broiler Mode supports this function.*

Feed Scale enables mixing different types of feeds from (up to) four different silos. The user fills each bin with the required feed type and sets the mixture ratios and quantities in Platinum. The augers then distribute the feed as defined.

##### 4.13.1 FEED SCALE MAIN SCREEN

This screen defines:

- the total quantity of feed to be delivered to the birds.
  - the auger feed mixture.
1. In *Install > Relay Layout* (page 139), define relays as augers as required.
  2. In *Management > Bird Inventory* (page 89), enter the number of birds.
  3. In *Scale > Scale Layout*, map the feed scales.
  4. Go to *Device > Feed Scale Program*.

FEEDING SCALE PROGRAM						
Day	Feed Per Bird	Silo (%)				Total Feed
		1	2	3	4	
1	0.200	70.0	10.0	10.0	10.0	4000
5	0.300	56.0	22.0	11.0	11.0	6000
12	0.400	0.0	0.0	0.0	0.0	0
20	0.300	0.0	0.0	0.0	0.0	0
0	0.000	0.0	0.0	0.0	0.0	0
0	0.000	0.0	0.0	0.0	0.0	0
0	0.000	0.0	0.0	0.0	0.0	0
0	0.000	0.0	0.0	0.0	0.0	0
<b>TODAY</b>						
		68.7	29.3	2.0		3636

5. Define:

- **Day:** Define the days at which the feed per bird changes. The controller calculates a feed curve based on these days and the feed per bird parameter. You can define the days as negative days. Enter the day number and press +/-.
- **Feed per Bird:** Define the amount of feed per bird/pigs (kilograms) to be distributed. Platinum calculates the total amount of feed to be distributed based on this parameter and the Bird Inventory parameters.
- **Silo (%):** If there is more than one silo supplying feed, enter the percentage of the feed package that each silo supplies. Note that by default, Silo 1 supplies 100% of the feed. Any number entered in Silo 2, 3, or 4 is subtracted from Silo 1.
- **Total Feed:** Displays the amount of feed required for that day. This amount is calculated by multiplying the feed per bird by the number of birds in the bird inventory (taking into account any birds culled, died, or moved).
- **Today:** These numbers display the actual amount of feed required for the current growth day. In the example shown above, the growth day is Day 2. The controller calculates the curve from Day 1 to Day 5 and adjusts the numbers accordingly.

4.13.2 FEED SCALE HELP | SET DEFINITIONS

FEED SCALE SETTINGS	
Time [hh:mm]	00:00
Max Portion Weight	25
Max Auger Time [min]	10
Not Empty Time [min]	5
Stop Diff 1 Weight	2.2
Stop Diff 2 Weight	2.2
Stop Diff 3 Weight	2.2
Stop Diff 4 Weight	2.2
Optimizer	Default
Valve Close Time [sec]	5
Feed Tare [A/D count]	0
Operating Mode	AUTO
Feed Rate Update Mode	AUTO
Feed Rate 1 [Weight/Min]	0.0
Feed Rate 2 [Weight/Min]	0.0
Feed Rate 3 [Weight/Min]	0.0
Feed Rate 4 [Weight/Min]	0.0

- Define:

- **Time:** What time the hopper begins distributing feed to the birds or animals.
- **Maximum Portion Weight:** Enter the feed scale container size.
- **Maximum Auger Time [minutes]:** This parameter sets an alarm for the auger running time. Enter the number of minutes that the auger can run, after which an alarm appears on the Main Screen.
- **Not Empty Time [minutes]:** This parameter sets an alarm for the feed scale container. The container should distribute all of its feed to the feed lines. If feed remains in the container, it could mean that there is a problem (for example, the valve doesn't open). Set the amount of time that feed can remain in the container, after which an alarm appears on the Main Screen.
- **Stop Differential 1/2/3/4 Weight:** After each silo stops supplying feed to its auger line, a certain amount of feed continues to flow. This differential compensates for this excess and ensures that only the required amount gets to the feed container. Enter the approximate amount of feed that can be found in the augers. The number does not need to be exact. In the following feed runs, Platinum will correct the amount entered.
- **Optimizer:** This parameter sets the unit's sensitivity to signal noise (caused by a variety of factors). The sensitivity plays a role as the controller stabilizes itself. Greater amounts of noise require faster optimization. To view an indication of the controller's stability, go to *Scale Menu > Test* (refer to page 61) and perform a test. If the number remains stable, slower optimization is indicated. There are three settings: Default, Slower, Faster.

*NOTE Munters recommends leaving this parameter at the default level.*

- **Valve Close Time [seconds]:** Set the delay in time, if any, that the valve emptying the feed scale container closes.
- **Feed Tare [A/D count]:** This specification is used for certain tests performed by a certified technician.

*NOTE Munters recommends leaving this parameter unedited.*

- **Operating Mode:** See following section.

### 4.13.3 OPERATING MODE

**Operating Mode (Version 6.22) enables:**

- Stopping and resuming feeding
- Initiating a feeding at any given time.

The parameter has three modes:

- **Auto:** Feeding operates according to the programming (default).
- **Bypass:** Feeding continues even if there is a problem with valves or scales. Valves remain open and augers continue to operate until the bypass state ends. During Bypass containers are filled by time (X kilos or pounds/minute).
- **Stop:** All feeding and feeding equipment stops.

**To use the Bypass Mode:**

1. From the drop-down list, select Bypass.
2. Define:
  - **Feed Rate Update Mode:**

- Auto: The controller uses the existing parameters to determine the feed rate. Note that if the user enters numbers in the Feed Rate Parameters, the controller will override these parameters if there is a contradiction between them and the existing parameters.
- Manual: The user enters the feed rate in the parameters below.
  - Feed Rate 1 – 4: Enter the amount of feed (kilograms or pounds) to be distributed by each auger per minute.

*NOTE* If a [hopper sensor](#) is installed, feed flow stops if there is an overflow alarm.

#### 4.13.4 FEED SCALE HOT SCREEN

Press "Right and Up Arrows" to view the Feed Scale Hot Screen.

FEED SCALE STATUS	
Status	Idle
Weight	1000
Auger 1	√
Auger 2	√
Auger 3	●
Valve	√
Feed S. Active	
Feed S. Interlock	
Hopper	Open
Intermediate	Open
Alarm	ON

This screen shows the status of different areas of the feeding apparatus. illustrates the system components.

- **Status:** Shows the feed scale status: Idle, Emptying, or Filling.
- **Weight:** Shows the feed scale container weight.
- **Auger 1/2/3/4:** Shows if the auger is running (√) or closed (●)
- **Valve:** Shows if the valve emptying the feed scale is open.
- **Feed S. Active:** This field shows which controller is managing the feed scale.
- **Feed S. Interlock:** The Feed Scale Interlock is a digital sensor which detects which damper is active.
- **Hopper:** The hopper is a digital sensor which detects if the feed has reached the maximum level in the feed bin. Define this sensor in *Install > Digital Sensor*. This screen shows the sensor's current status. If the feed reaches the maximum amount, an alarm is triggered.
- **Intermediate:** The intermediate sensor is a digital sensor which detects if the feed has reached the maximum level in the feed bin. Define this sensor in *Install > Digital Sensor*. This screen shows the sensor's current status. If the feed reaches this sensor, an alarm is generated.
- **Alarm:** This parameter shows if there are active alarms. View the alarms on the Main Screen.

#### 4.13.5 FEED SCALE FUNCTIONALITY IN TWO HOUSES

Platinum Pro/Rotem Pro enables sharing feed scale functionality between two houses. Two load cells are connected to a single feed scale. Each Controller is connected to one load cell.

When the system is running, one controller operates each set of augers, feed scale valve, hoppers, and so on. A mechanical damper switches the feed supply from the scale to the corresponding hopper. Only one feed process operates at a time; when one process is running the second is in standby.

- Each hopper auger is managed by a separate feed sensor, installed in the last dish in the last feed line in each house.
- Both units are connected to a single feed scale container.
- Contactors connected to the silo augers determine which house is active.
- Each controller is connected to a separate hopper sensor, which indicates when the hopper is filled.
- Important: Each Controller transmits the Feed Scale State to the second controller, via the Feed Scale Active Relay. This relay prevents a controller from assuming control of the Feed Scale when the latter is active. Controller 1 will release control if:
  - One of the following is true:
    - The hopper sensor shows the hopper to be filled.
    - The feed cycle is complete.
  - In addition, if an Auger Overtime alarm is generated, control is transferred to the other Platinum.
- Hot key (see Feed Scale Hot Screen)

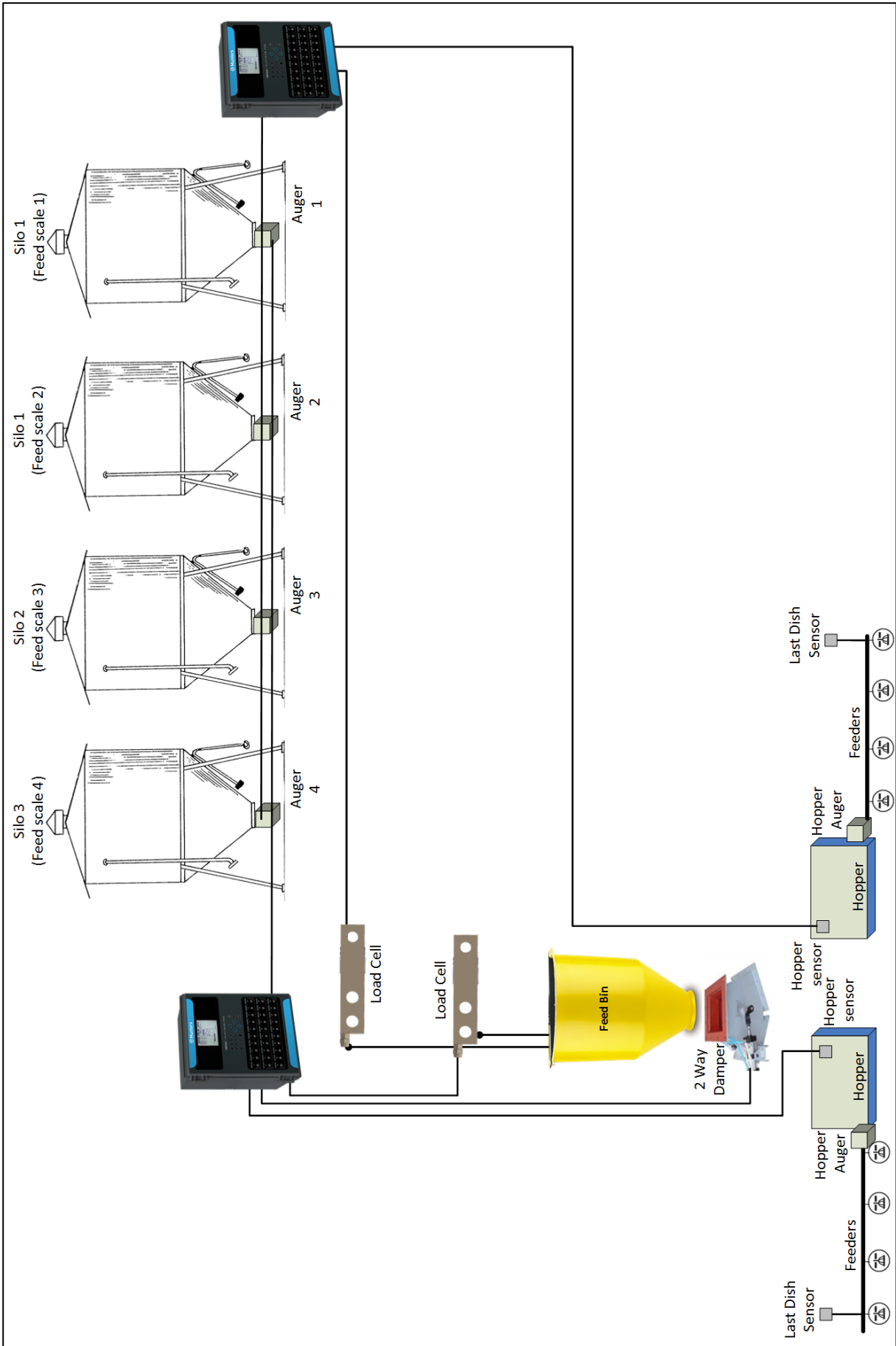

Figure 7: Feed scale block diagram

To set up the Feed Scales:

➡ Refer to the Installation manual on wiring the Controllers to the Feed Scale and Load Cells.

1. Go to *Install > Relay Layout*.
2. Define a relay as Feed S. Active.

RELAY LAYOUT			
Relay	Function	Num	NO/NC
1	Vent Open	1	—
2	Vent Open	2	—
3	Vent Close	1	—
4	Vent Close	2	—
5	Heat	1	—
6	<b>Feed. S. Active</b>	1	—
7	Curtain Open	1	—
8	Curtain Close	1	—
10	< None >	9	< None >
N.O. Relay			

3. Go to *Install > Digital Sensor*.

4. Define one sensor as Hopper Sensor and one sensor as Feed Scale Interlock.

DIGITAL SENSORS		
In	Function	Num
1	Hopper Sensor	1
2	Feed Scale Interlock	1
3	Cool Pad Water Meter	1
4	Fogger Water Meter	1
5	Water Meter	2
6	< None >	0
7	< None >	0
8	< None >	0



# 5 Manage Menu

The following sections detail the Management Menu.

- Inventory, page 89
- Feed Inventory, page 90
- Time & Date, page 91
- Growth Day & Flock, page 91
- Alarm Setting, page 92
- Alarm Reset, page 96
- Fail Safe Setting, page 98
- Password, page 98
- Relay Current, page 99
- RDT-5 / Temperature Curve, page 100



Figure 8: Broiler/Layers Device Menu



Figure 9: Pigs Device Menu

## 5.1 Inventory

Maintain your bird inventory by entering data into the controller.

BIRD INVENTORY			
	Male	Female	Total
Add Dead Birds	0	0	0
Add Culled	0	0	0
Birds Moved	0	0	0
Birds Placed	10000	5000	15000
Today's Dead Birds	35	33	68
Today's Culled	12	10	22
Total Dead Birds	35	33	68
Total Culled	12	10	22
Total Birds Moved	1020	510	1530
Bird Count	8933	4447	13380

ANIMAL INVENTORY			
	Male	Female	Total
Add Dead Animals	0	0	0
Add Culled	0	0	0
Animals Moved	0	0	0
Animals Placed	10000	5000	15000
Today's Dead Animals	35	33	68
Today's Culled	12	10	22
Total Dead Animals	35	33	68
Total Culled	12	10	22
Total Animals Moved	1020	510	1530
Animals Count	8933	4447	13380

Figure 10: Broilers/Layers Inventory Screen    Figure 11: Pigs Inventory Screen

- Maintain bird inventory by entering quantities in the upper half of the screen. There are separate columns for male and female. If you do not wish to keep separate data, simply enter the data into one or the other.
- Initially, enter the number of birds placed. Thereafter, enter the quantity found dead, culled (Add Culled) or moved as needed. The shows totals and subtotals in the lower portion of the screen.
- You can correct an error, so long as you correct it on the same day before midnight, by entering a negative quantity (press the +/- key after the number) to subtract the error. After midnight, the information transfers to the History Menu.

## 5.2 Feed Inventory

Maintain your feed inventory by entering data into the controller. The software version determines the function's parameters.

FEED INVENTORY					
No.	Date	Silo			
		1	2	3	4
1	2-Jan-08	7800	0	0	0
2	5-Jan-08	0	9000	15000	10000
3	13-Jan-08	8000	0	0	0
4	- -	0	0	0	0
5	- -	0	0	0	0
6	- -	0	0	0	0
7	- -	0	0	0	0
8	- -	0	0	0	0
Total Feed:		15800	9000	150000	10000
ACTIVE		√	√	√	√

To enter feed inventory manually:

1. Type the day of the month and press ENTER.
2. Select the month and press ENTER.
3. Type the two-digit year and press ENTER.
4. Enter the feed quantity under the silo and press ENTER. The cumulative total appears in the Total Feed row.
5. To delete an entry, change the quantity to zero for all silos and press ENTER. Exit the menu and the entry disappears when you enter the menu again.

If you have installed load cells and connected silo scales to your Controller, it automatically maintains feed inventory, including delivery dates and feed consumption data. You can monitor your fill system and maintain approximate feed inventory using the [Digital Inputs](#). In this case, you need to enter your own delivery dates.

This information transfers to the *History > Water and Feed* menus daily, or optionally as often as selected (by the minute) in History View.

## 5.2.1 FEED INVENTORY HELP | SET DEFINITIONS

② While viewing the Feed Inventory menu: Press **HELP**, select **SET** and press **ENTER**.

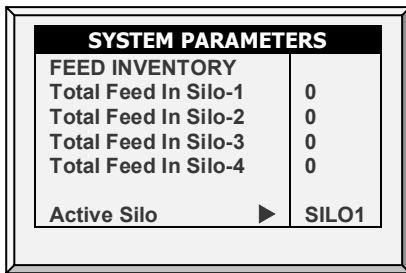

SYSTEM PARAMETERS	
FEED INVENTORY	
Total Feed In Silo-1	0
Total Feed In Silo-2	0
Total Feed In Silo-3	0
Total Feed In Silo-4	0
Active Silo	▶ SILO1

- Total Feed in Silo-1/ -2/ -3/ -4: Manually change or correct the amount of feed in the silos.
- Active Silo: Select the required silo for use. It is possible to select all of them.

## 5.3 Time & Date

This menu sets the current time and date for the controller.

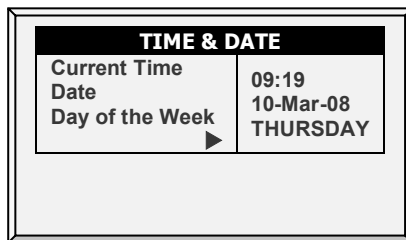

TIME & DATE	
Current Time	09:19
Date	10-Mar-08
Day of the Week	▶ THURSDAY

- Current Time: Enter the current time in 24-hour format.
- Date: Enter the date in day-month-year format.
- Day of the Week: Select the day of the week from the drop-down menu.

## 5.4 Growth Day & Flock/Group

This menu defines the number of growth days and flock number.

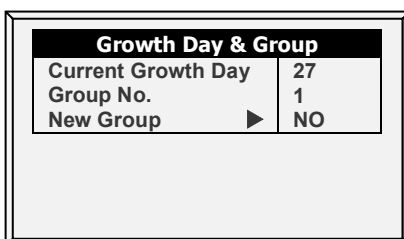

Growth Day & Group	
Current Growth Day	27
Group No.	1
New Group	▶ NO

Figure 12: Pigs Growth Day and Flock

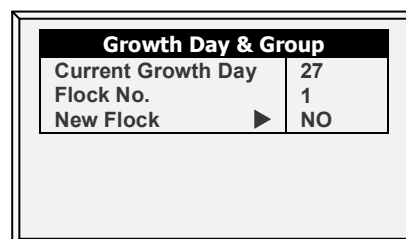

Growth Day & Group	
Current Growth Day	27
Flock No.	1
New Flock	▶ NO

Figure 13: Poultry Growth Day and Flock

- Current Growth Day: Enter current growth day, if necessary. It is possible to enter negative growth days up to -7. If you reset the growth day for a new flock using this tool, your old history data does not clear. Use New Flock function to clear out old history in preparation for new birds.
- Group/Flock No.: The controller automatically increments the flock number each time you choose New Flock. You can edit the flock number. Since this field

accepts six digits, some producers enter a flock number that is made of the day, month, and year the birds arrived.

- **New Group/Flock:** Use the new flock function on arrival of a new set of birds to set the growth day from 1 to -7, and to clear out old history data.

## 5.5 Alarm Setting

This menu defines the various alarm settings.

- Alarm Setting Help | Set Definitions
- Prioritizing Alarms

ALARM SETTING	
Global Alarm Delay (sec)	1
Alarm Reminder (min., 0-Disable)	30
SENSOR ALARM	
Sensor Low Temp. Range	32.0
Sensor High Temp. Range	122.0
Sensor Alarm-Diff From Lo. Alarm	1.0
Sensor Alarm-Diff From Hi. Alarm	1.0
ALARM	
Alarm Test At Time: (hh:mm)	12:00
Day Of Alarm Test: <input type="checkbox"/>	DAILY
Alarm Test Duration (sec)	0
AUGER OVERTIME ALARM	
Auger Overtime Delay (minute)	15

**NOTE** See Fail Safe Setting.

- **Global Alarm Delay (sec):** Alarms without a separate alarm delay, use this global delay before signaling the alarm.
- **Alarm Reminder (min., 0-Disable):** Amount of time before a reminder is sent if the situation has not yet been corrected.

### Sensor Alarm

- **Sensor Low Temperature Range:** Sets the minimum reading a sensor can have to be considered a valid sensor reading. Sensor readings below this are rejected. This generates a sensor out of range alarm. This does not apply to the special Circuit Breaker Sensor or Outside Temperature Sensor.
- **Sensor High Temperature Range:** Sets the maximum reading a sensor may have to be considered a valid sensor reading. Sensor readings above this reading are rejected. This generates a sensor out of range alarm. This does not apply to the special Circuit Breaker Sensor or Outside Temperature Sensor.
- **Sensor Alarm-Differential from Low Alarm:** Individual sensor (or zone) alarm if any active sensor reads this much or more below the [Control | Temperature Curve | Low Alarm Temperature](#).
- **Sensor Alarm-Differential from High Alarm:** Individual active growth area sensors alarm if they read this much or more above the [Control | Temperature Curve | High Alarm Temperature](#).

### Alarms

- **Alarm Test at Time:** Schedule the alarm test time.

- **Day of Alarm Test:** Choose **Daily** or a particular day of the week for the scheduled alarm.
- **Alarm Test Duration (sec):** Choose the alarm test duration.

### Auger Overtime Alarm

- **Auger Overtime Delay:** Set the maximum auger run time for your cross-fill system. If you have a monitor connected to the digital inputs programmed as Feeder-1 Overtime or Feeder-2 Overtime the Platinum Pro sends an alarm after this delay.
- **Feeder Off During Overtime:** Choose whether to shut the feed systems off after a feeder overtime alarm. Options:
  - **No:** All augers and feeders remain on.
  - **All:** All augers and feeders shut down.
  - **Related:** Only the specific auger from which the alarm originated and its feeders shut down.

*NOTE If you choose All or Related, the feed system turns off and does not resume until you [Reset Alarm](#) in the Management Menu.*

### Feeder Overtime Alarm

- **Feeder Overtime Delay:** Set the maximum feeder run time for your cross-fill system. If you have a monitor connected to the digital inputs programmed as Feeder-1 Overtime or Feeder-2 Overtime the controller sends an alarm after this delay.
- **Feeder Off During Overtime:** Choose whether to shut the feed systems off after a feeder overtime alarm. Options:
  - **No:** All augers and feeders remain on
  - **All:** All augers and feeders shut down.
  - **Related:** Only the specific auger from which the alarm originated and its feeders shut down.

*NOTE This alarm functions in Broiler mode only.*

*NOTE Setting the Feeder Off During Overtime to All in either the Auger Overtime Alarm or the Feeder Overtime Alarm shuts down the augers and feeders, regardless of the other alarm's setting.*

### Auger Empty Alarm

- **Condition Detection Delay (sec.):** The controller sends an alarm when the current goes to the level set in the following parameter after this delay.
  - **Below Nominal Current:** Send an alarm when the nominal current drops to this level.
- This alarm is operative only if 1) Current Sense Relays are installed and calibrated 2) augers have been calibrated.

## 5.5.1 ALARM SETTING HELP | SET DEFINITIONS

- ② While viewing the Alarm Setting menu: Press **HELP**, select **SET** and press **ENTER**.

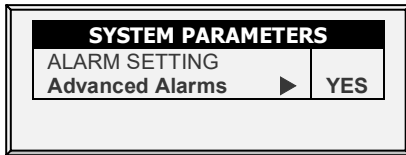

- **Advanced Alarms:** When selecting YES, the following additional alarms appear on the ALARM SETTINGS screen (press MENU and then ENTER to reenter the screen):

### Water on Demand Alarms

- **High/Low Pressure Diff (PSI):** Sends an alarm when the difference between the current WOD pressure and the defined pressure reaches these levels. 0 means that the alarm is disabled.
- **Shutdown Pressure Diff (PSI):** Shuts down the Water on Demand system when the pressure reaches this level.
  - Shutdown pressure must be equal to or higher than the High/Low Pressure Difference.
  - However, to disable this alarm set it to 0 (zero), even if the High/Low Pressure is above 0.

### Feed Alarms

- **Allow Feed Alarm From/To:** Set a starting time from which the controller can send feed shortage alarms.
- **Low Feed Alarm Limit:** Alarm if feed in Silo 1/2/3/4 is below this limit and time is between From and To limits.
- **Feed Alarm Limit (per hour):** An alarm is generated if the feed flow is greater than this amount. This alarm is activated when a problem arises inside the barn (as opposed to when something happens to the feed scale).

### Water Overflow Alarms

**NOTE** In the event of a water overflow alarm, the transmitted alarm cites which water meter is the source of the overflow.

- **According to Light Table:** Change overflow alarm level when the lights are off.
- **First Day:** Overflow on the FIRST day applies to the first day operation. You can define a first day at which to start increasing the overflow limit automatically. Days prior to the 'First Day' use the First Day overflow limit; days following the first day have an incremental curve toward the LAST DAY OVERFLOW parameter setting.
- **Overflow on First Day:** Number of gallons/liters per minute that generate an overflow alarm on the first day.
- **Last Day:** Set the last day for the overflow curve.
- **Overflow on Last Day:** Set the maximum overflow limit (gallons/liters) for those days following the last curve day.
- **Overflow At Dark:** Select overflow limit. When it is dark, the controller checks every minute.

- **Overflow Alarm Delay:** Define delay time before the controller generates an overflow alarm.
- **Extra Delay At Light Start:** When the first light appears, define the number of minutes before the controller begins to operate according to the set Overflow for that day.
- **Fogger Water Overflow:** Define the water overflow for foggers (per minute).
- **Water Off During Overflow (Version 6.23):** Choose whether to shut the water off after a water overflow alarm. Options:
  - No: Water lines remain on
  - Yes: When a water meter sends an alarm, the corresponding water line turns off.

### Water Shortage Alarms

- **Allow Water Shortage Alarm From/To:** Set the period for which the controller generates water shortage alarms.

*NOTE In Version 6.23, Water Shortage Alarms are only sent during the times when the water lines are operating. Water operation times are defined in Water & Feed, page 70.*

- **Shortage During Lights Off:** Select whether water shortage alarm is disabled when all lights are out.
- **Quantity for Shortage:** Minimum flow rate that must be maintained or a water shortage alarm is generated.
- **Shortage Alarm Delay:** Minimum period of time that the shortage must extend through before generating an alarm.
- **Shortage Start Day:** Define on what day shortage alarms begin. This parameter prevents false alarms caused by young birds' low water usage. Default: 0 (meaning alarms function normally throughout the growth cycle).

### Bird Scales Alarms

- **Allow Bird Scale Alarms From/To:** Set time frame for which the controller begins and ends generating alarms for the bird scale.

### Auxiliary Alarms

- Assign auxiliary alarms in the Install > Digital Sensors menu. Note that digital sensors, auxiliary alarm input with related relay must always match their relay status.
- **Related Relay For Aux Alarm 1/2/3/4:** Map a relay to the digital auxiliary alarm 1/2/3/4.
- **AUX. Alarm Delay (sec):** Separate from the Global Alarm Delay. If there is a dry contact, the alarm is sent after the defined AUX. Alarm Delay.
- **Aux Alarm D.I. Contact:** Alarm contacts can operate in Normally Open or Normally Closed format. Normally Open relays close where energy is applied; if current is interrupted, the relay opens and an alarm is sent. Normally Closed relays open when voltage is applied; when current is interrupted the relay closes and an alarm is sent. By default, Auxiliary Alarms are defined as NO.

### Circuit Breaker Alarm

- **Temperature for Circuit Breaker Alarm:** Set circuit breaker alarm temperature.

### CO2 Sensor Alarm

- **CO2 High Level:** Set the maximum allowed CO2 level above which an alarm is sent. The alarm ceases when the CO2 drops below this level. If the user acknowledges the alarm, the alarm messages temporarily cease (for the reminder time).

### Humidity Sensor Alarm

**Humidity Alarm Enabled:** Mark this parameter as Yes to enable the Humidity High Level alarm and the Humidity Sensor Fail alarm.

- **Humidity High Level:** Set the maximum allowed humidity level above which an alarm is sent. The alarm ceases when the humidity drops below this level. If the user acknowledges the alarm, the alarm messages temporarily cease (for the reminder time).

### Ammonia Alarm

- **Ammonia High Level:** Set the ammonia level at which an alarm is sent.

### Secondary Alarms

- **Enable Secondary Alarms:** Refer to Prioritizing Alarms, page 96.

### Potentiometer Alarm

- **Enable potentiometer alarms,** which send an alarm when potentiometer-controlled devices fail.
  - Set the time frame **OR**
  - If the from/to times are set to 0:00 (default) alarms are sent 24/day.

### Low Light Intensity Alarm

- **Low Light Alarm Enabled:** Alarm sent when the measured light is less than 50% of the requested LUX target.

*NOTE Version 6.20 supports this alarm. It is active only when a LUX sensor is installed and the alarm is enabled. In addition, the dimmer output value must be set to maximum output for the corresponding active light program line.*

### Auger Under Runtime

- **Auger Under Runtime (hours):** Define augers as required. Define a digital sensor as Auger Overtime Sensor. If the alarm contactor does not turn on within the time defined in this parameter, an alarm is generated. (Version 6.22)

## 5.5.2 PRIORITIZING ALARMS

You can prioritize alarms. When enabled:

- ventilation-related alarms are defined as critical. The main alarm relay will transmit these alarms to the device wired to the relay (for example, a dialer).
- non-ventilation alarms are defined as non-critical. A secondary relay will transmit alarms to another device (for example, an ELS).



To prioritize alarms:

1. Go to Install > Relay Layout.
2. Define a relay as Alarm (N.C.).
3. Go to Manage > Alarm Setting > Help.
4. Enable Advanced Alarms.
5. Go to Manage > Alarm Setting.
6. Scroll to Secondary Alarms and define as Yes.

## 5.6 Alarm Reset

This menu functions as an alarm and siren reset.

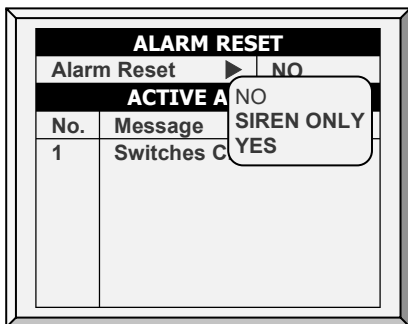

Alarm Reset:

- **NO:** Does not reset alarms
- **SIREN ONLY:** Resets only the siren, alarms remain
- **YES:** Resets alarms

Selecting YES:

- Clears the alarm relay for all current alarms. The alarms may remain valid, but the unit does not register new alarms. If a new alarm occurs, or an existing alarm clears and reoccurs, the alarm relay signals again (after any appropriate delay).
- Restores normal operation after an emergency pressure or feed overrun incident. If the controller experiences a high-pressure alarm for too long, it enters emergency pressure operation by opening all known air sources. Curtains open to preset amounts as set in Static Pressure, page 43.
- If you select SIREN ONLY, the alarm relay returns to the no alarm condition, but the emergency pressure status continues.
- Restores normal operation after a feed overrun situation that calls for turning off the feeding system. If the feed monitor senses the cross auger runs too long, it trips a feed overrun alarm and optionally turns off the feed system. If you select SIREN ONLY, the alarm relay returns to the no alarm condition, but the feed overrun status continues.

## 5.7 Fail Safe Setting

When there is a problem such as extremely high air temperature, the Fail-Safe function immediately activates a backup system (for example the RBU-27) to ensure that adequate ventilation continues.

FAIL SAFE SETTING	
Alarm Type	Select
High Temp.	✓
Low Temp.	•
Low Static Pressure	✓
High Static Pressure	✓
Avg. Temperature Fail	•
AUX.	•
CO2	✓

The Platinum Pro/Rotem Pro has six options besides controller failure or power off to activate the fail-safe relay. Apply the additional settings by using the '+/-' key:

- **High/Low Temperature:** Select to trigger fail-safe when the temperature is exceptionally high/low.
- **Low/High Static Pressure:** Select to trigger fail-safe when the static pressure is exceptionally low/high.
- **Avg. Temperature Fail:** Select to trigger fail-safe when all sensors in house fail.
- **AUX:** Select to trigger fail-safe when auxiliary dry contact occurs.
- **CO2:** Select to fail-safe when the measured CO2 levels rise above permitted levels (Version 6.24 and above).

## 5.8 Password

PASSWORD	
Owner Password	----
User-1 Password	----
User-2 Password	----
User-3 Password	----
User-4 Password	----
User-5 Password	----
Visitor Password	----

The owner can set new passwords for himself, all users and visitors. The owner cannot see user passwords once entered or changed by the users. The users can access the controller and make changes to all controller settings and their own password. A user can only see and change his/her own password. The visitor can access the controller but cannot make changes. Each time someone accesses the controller with a password, an event is recorded in the [History | Table of Events](#).

*NOTE If your controller uses passwords, the controller also requires a password entry to acknowledge switch position changes. If the switch change is not acknowledged the controller signals an alarm.*

## 5.9 Relay Current

*NOTE The Relay Current feature supports single phase electricity only.*

This menu configures the relay current sense parameters. You can configure:

- the minimum and maximum amperage flowing to the relays
- the relay current alarm
- voltage type

*NOTE Configuring the amperage is not required. The controller automatically configures default settings.*

RELAY CURRENT SETTING						
Rly.	Function	Min	Nom	Max	Alr	Vlt
31	Heat 6	2.7	3.8	5.0	NO	110
32	Heat 7	2.7	3.8	5.0	NO	110
33	Heat 8	3.0	3.8	5.6	NO	110
34	Exh. Fan 5	2.7	4.3	5.0	NO	110
35	Exh. Fan 6	2.3	3.8	5.0	NO	110
36	Tun. Fan 1	3.0	4.3	5.6	NO	110
37	Tun. Fan 2	0.0	0.0	0.0	NO	110
38	Tun. Fan 3	0.0	0.0	0.0	NO	110

*NOTE Calibrate the relay before configuring these parameters. Refer to Current Sense Relay Calibration, page 133. Relays that are not calibrated (or if the relay is not a Current Sense relay) do not display amperage readings (see relays 37 and 38 in the above figure).*

To configure the relay current:

1. Using the arrow buttons, select a minimum or maximum amperage setting.
2. Configure the parameter as required.

*NOTE The minimum amperage must be greater than the default minimum and the maximum amperage must be less than the default maximum. For example, relay 35's amperage must be more than 2.3 and less than 5.0 amps.*

*The Nom amperage is the parameter set when calibrating the relay (refer to Relay Current, page 99).*

3. Configure the alarm:

- No: Alarms are not sent in the event of low or high current
- Yes: Alarms are sent in the event of low or high current
- No at zero: The controller sends an alarm if the current is low or high, but not if power is cut off entirely.

4. Configure the voltage: Select 110 or 220 volts.

*NOTE All relays' minimum/maximum current settings per equipment type must be within 30% (±) of the nominal value. However, the augers minimum can go down to 0.0 amperes.*

## 5.10 RDT-5 / Temperature Curve

- Munters RDT-5 is a five-stage digital thermostat that works in conjunction with Platinum Pro/Rotem Pro Controllers or as a stand-alone unit. When wired to the Controller, you can use the Controller to set the RDT-5's stage activation temperatures (which is easier than setting the temperatures on the RDT-5 screen). The stage activation temperature determines when cooling and heating operations take place. RDT-5 supports a 10-point temperature curve.
- Version 6.20/7.20 supports two RDT-5 units.
  - If your system includes two RDT-5 units, verify that the controller identifies both in Hardware Checklist, page 120.
  - Ensure that each unit has a unique address (refer to the RDT-5 Manual for details).
  - After installing the RDT-5 units, perform a Cold Start.

RDT-5 / TEMPERATURE CURVE						
Day	Temp.	Stage 1 HEAT	Stage 2 HEAT	Stage 3 COOL	Stage 4 COOL	Stage 5 COOL
2	31.0	29.0	26.0	33.0	35.0	37.0
5	33.0	31.0	28.0	35.0	37.0	39.0
7	35.0	33.0	30.0	37.0	39.0	41.0
10	37.0	35.0	32.0	39.0	41.0	43.0

RDT-5 STAGE DIFF				
Stage 1	Stage 2	Stage 3	Stage 4	Stage 5
-2.0	-5.0	2.0	4.0	6.0

- ➔ Wire the communication card to the RDT-5's communication card. Refer to the RDT-5 manual for details.
  1. In Install > Communication, define the expansion device as Dig. Thermostat.
  2. In Management > RDT-5 / Temp. Curve, define the parameters (up to a 10-point curve).
    - Day: The growth day
    - Temp.: The target temperature for that day.
    - Stage 1 – 5: The temperatures at which heating or cooling starts (read only)
    - RDT-5 Stage Difference: The differences from the target temperature at which heating or cooling starts at each stage (read only; set these numbers in the Help).

Platinum Pro/Rotem Pro automatically calculates and displays the stage activation temperatures.

**CAUTION** Verify that the RDT-5's growth day and the controller's growth day are the same! Days set differently means that the temperature curves will be asynchronous.

3. In RDT-5 / Temperature Curve> Set Definitions, define the parameters as required.

Notes:

- Storing the temperature curve:

- Version 6.18 and below: The controller does not store these temperatures; RDT-5 does. If you connect the controller to a different RDT-5 unit, you must re-enter the temperature curve.
- Version 6.19, refer to Saving and Loading RDT-5 Tables.
- If you previously defined the temperature curve in the RDT-5, the controller retrieves the data and you can edit the data in this screen.
- When connecting the RDT-5 to a Platinum Pro/Rotem Pro Controller:
  - If an Extension box is currently connected to the controller, a message appears in the Message box when you disconnect the Extension box. However, no alarm is sent out.
  - After configuring the RDT-5, disconnect the unit from the Controller and reconnect the Extension box. If the Extension box is not reconnected, the controller sends out alarms.

### 5.10.1 RDT-5 / TEMPERATURE CURVE | SET DEFINITIONS

- ② While viewing the RDT-5 / Temperature Curve menu: Press **HELP**, select **SET**, and press **ENTER**.

RDT-5 STAGE SETTINGS	
Stage 1 Diff	-2.0
Stage 2 Diff	-5.0
Stage 3 Diff	2.0
Stage 4 Diff	4.0
Stage 5 Diff	6.0
Stage 1 Type	HEAT
Stage 2 Type	HEAT
Stage 3 Type	COOL
Stage 4 Type	COOL
Stage 5 Type	COOL

- Define the parameters as required:
  - Stage 1 – 5 Diff: Enter the difference from the target temperature that activates a heater or cooler for each stage. These numbers appear on the RDT-5 / Temperature Curve screen.
  - Stage 1 – 5 Type: Select Heat or Cool. Each RDT-5 relay serves as a heater or cooler relay. This parameter enables displaying the relay definition on the screen.

**CAUTION** *Selecting Heat or Cool in this screen does not define the relay; it only displays the relay type. Actual relay definition is done in the RDT-5 unit, by placing a jumper on certain pins. Meaning: if a relay is defined in this screen as a heater, but the jumper placement defines the relay as a cooler, the relay is a cooler. Refer to the RDT-5 manual for details.*

### 5.10.2 RDT-5 DIGITAL ALARM

If required, define up to two digital sensors to send an alarm noting that an RDT-5 is functioning. Refer to Digital Sensors, page 142. Connect the RDT-5 Backup Active Port to the controller’s digital input card. Refer to the installation manual.

**CAUTION** *Verify that the input port defined in Installation > Digital Sensors matches the port on the digital input card used to connect the units!*

### 5.10.3 SAVING AND LOADING RDT-5 TABLES

In Version 6.19, the Platinum Pro/Rotem Pro controllers store (backup) the RDT-5 temperature curve tables. This function enables transferring the tables from a configured RDT-5 to another, unconfigured RDT-5.

To transfer settings:

1. Wire an RDT-5 unit to the controller, perform a [Cold Start](#) (page 18), and define the temperature curve on the RDT-5 or on the controller (see the above sections).
2. Save the controllers settings to an SD card. Refer to Saving to an SD card, page 130 for details.
3. Connect the second RDT-5 unit to the controller and perform a [Cold Start](#)
4. Upload settings from the SD card. Refer to Loading from an SD card, page 132 for details. Verify that you are uploading the correct file!

**NOTE** *If there is any interruption while uploading settings, the tables may not transfer. In this case, a message will appear informing you of the issue.*

### 5.10.4 RDT-5, VERSION 6.22

In Platinum Pro Version 6.22.01, the growth day and days in the temperature curve can be set to -7 & up. RDT-5 Version 1.5.8 also supports this feature. However, if, when used together one of the products is operating using legacy software, there can be operational errors. The following table explains possible errors if the growth day and RDT-5 temperature curve days are defined as negative days when using legacy software for either product.

	Platinum V6.22	RDT-5 Ver 1.5.8
Platinum Pro V6.21		<ul style="list-style-type: none"><li>• Negative days in the RDT-5 appear incorrectly.</li><li>• RDT-5 functions may not operate properly.</li></ul>
RDT-5 Ver < 1.5.8	Negative days are not transmitted to the RDT-5. Both units operate as if they are operating using legacy software.	

**CAUTION** *Munters recommends that users who employ RDT-5 units update that product's software when you update the Platinum Pro software to Version 6.22.*

# 6 Scale Menu

The following sections detail the weighing functions. This chapter deals with Version 6.22 and above. Users configuring previous versions should refer to Appendix D: Previous Version Functions, page 181.

- Weighing Summary, page 103
- Non-Gender Based Weighing, page 104
- Gender Based Weighing, page 107
- Silo Setting, page 109
- Feed Conversion, page 110
- Test, page 110
- Calibration, page 111
- Silo / Auger Layout, page 112

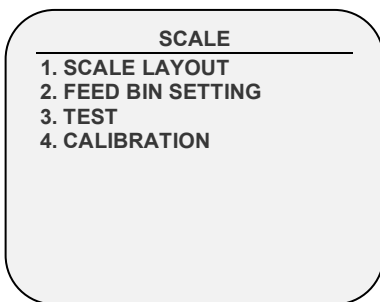

Figure 14: Pig Mode Scale Menu

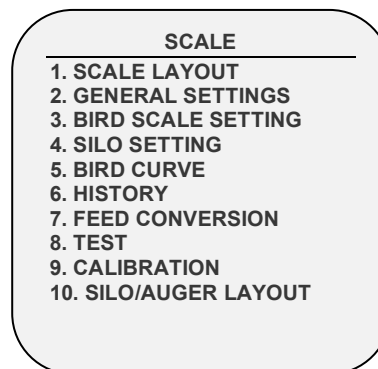

Figure 15: Layer/Broiler Mode Scale menu

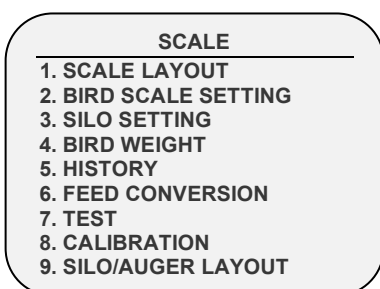

Figure 16: Layer/Broiler Mode Scale menu (Version 6.19)

## 6.1 Weighing Summary

In Versions 6.22 or above, setting up a bird curve means defining the following items in the Scale Menu:

- [Scale Card](#): Define at least one scale.
- Gender Separated Weighing: Define if weight curves are gender separated.

- [Non-gender separated](#) weighing provides an automatic curve, a user-customized curve, or industrial standard curves.
- [Gender separated weighing](#) provides automatic curve, an automatic turkey curve, or a user-customized curve.
- [Bird Scale Setting](#): Define the curve type (Auto, Custom, or Factory Curve)
- [Bird Weight](#): Define the reference weight or curve data points (day and weight).

*NOTE Users employing a previous software version, refer to Appendix D: Previous Version Functions page 181.*

## 6.2 Non-Gender Based Weighing

- Scale Layout
- Bird Scale Setting
- Bird Weight

### 6.2.1 SCALE LAYOUT

Use Scale Layout to define the scales or silos connected to the controller.

- Scale Layout Main Screen
- Scale Layout | Set Definitions

#### 6.2.1.1 Scale Layout Main Screen

*NOTE A scale card must be installed in the controller or an RSU-2 unit must be connected to the controller for these screens to appear.*

Platinum Pro/Rotem One supports the RSU-2 and two types of scale cards:

- Two channel scale cards: Supports bird scales only.
- Six channel scale cards: Supports bird, silo, and feed scales (Breeder Mode does not support feed scales). The controller can support up to ten weighing channels.
- Refer to the installation manual regarding Munters' recommendations regarding these options.

SCALE LAYOUT		
Scale Card		
Chan.	Function	No.
1	Silo 1	1
2	Silo 2	2
RSU 1		
1	Silo 3	3
2	Silo 4	4

Figure 17: Two Channel Layout

SCALE LAYOUT		
Ch.	Function	No.
Scale Card		
1	Scale	1
2	Scale	2
3	Silo	1
4	Silo	2
5	Feed Scales	1
6	Scale	3
RSU 1		
1	Silo 3	3
2	Scale 3	3

<None>  
1. Scale  
2. Silo  
3. Feed Scales

Figure 18: Six Channel Layout



### 6.2.1.2 Scale Layout | Set Definitions

② While viewing the Scale Layout menu: Press **HELP**, select **SET**, and press **ENTER**.

SYSTEM PARAMETERS	
SCALE LAYOUT SETTINGS	No
Separate Male Female	Yes

- If male and female birds live in the same house, select No.
- If you want separate male/female weight curves, refer to Gender Based Weighing, page 107.

### 6.2.2 BIRD SCALE SETTING

*NOTE This screen relates to Version 6.19 and above.*

➡ Define at least one scale, silo, or feed scale in Scale Layout.

This section describes the Bird Scale Settings for Broiler mode. Refer to Breeder and Layer Mode appendices to view the function for those modes.

- Bird Scale Setting Screen
- Bird Scale Setting | Set Definitions

#### 6.2.2.1 Bird Scale Setting Screen

In this screen, select the algorithm used to calculate the bird curve that appears in Bird Weight. There are three options:

BIRD SCALE SETTING	
Weighing Method	Auto

Auto  
Custom  
Cobb 500  
Cobb 700  
Ross 308  
Ross 708

- **Auto:** Set the first target weight. The controller then automatically calculates each day's reference weight.
- **Custom:** The controller provides a weight vs growth day curve, which the user can edit as required.
- **Factory Default Curve:** The controller loads an industry standard bird curve. This curve cannot be edited.

### 6.2.2.2 Bird Scale Setting | Set Definitions

- ② While viewing the Bird Scale Setting menu: Press **HELP**, select **SET**, and press **ENTER**.

BIRD SCALE SETTING	
Range Method	Auto Manual

This parameter defines the range of weights that are recorded. Bird weights that are outside of the band are discarded.

- If you select Auto, Platinum automatically calculates the band of acceptable weights.
- If you select Manual, define the upper and lower ranges.

BIRD SCALE SETTING	
Range Method	Manual
Upper Range [%]	25
Lower Range [%]	25

### 6.2.3 BIRD WEIGHT

- Bird Weight Main Screen
- Bird Weight Help | Set Definitions

#### 6.2.3.1 Bird Weight Main Screen

In this screen, edit the bird curve selected in Bird Scale Settings.

- Go to Scale > Bird Weight.
  - If you selected Auto in Bird Scale, edit the weight as required. The weight is automatically adjusted.

BIRD WEIGHT	
Current Weight	0.09

- If you selected Custom in Bird Scale, edit the curve as required.

BIRD WEIGHT	
Day	Weight
0	0.00
7	0.00
14	0.00
21	0.00
28	0.00

- If you selected an industrial standard, the curve is read only.

BIRD WEIGHT	
Day	Weight
0	0.09
1	0.14
2	0.16
3	0.20
4	0.24

### 6.2.3.2 Bird Weight Help | Set Definitions

*NOTE This option is only available if you choose Custom or an industrial standard curve.*

- ① While viewing the *Bird Curve* menu: Press *HELP*, select *SET* and press *ENTER*.
  - Enter the factor used to adjust the weight curve. This amount is added to the Reference weight field. Range: 0.0 – 10.0 Kg/Lb.

BIRD WEIGHT	
Curve Offset	0.2

## 6.3 Gender Based Weighing

Version 6.22 provides an option for gender-based weighing.

1. Go to Scale Layout > Help.

SYSTEM PARAMETERS	
SCALE LAYOUT SETTINGS	No
Separate Male Female	<b>Yes</b>

2. Select Yes.
3. Go to Scale Settings > Bird Scale Setting > Help. Select Auto or Manual.

BIRD SCALE SETTING	
Range Method	Auto Manual

This parameter defines which measured bird weights are used in calculating the actual curve. Bird weights that are outside of the band are discarded.

- If you select Auto, Platinum calculates the band of acceptable weights.
- If you select Manual, define the female/male upper and lower weight ranges.

BIRD SCALE SETTING	
Range Method	Manual
<b>Female</b>	
Upper Range [%]	10
Lower Range [%]	15
<b>Male</b>	
Upper Range [%]	15
Lower Range [%]	10

4. Go to Scale Settings > Bird Scale Settings.

BIRD SCALE SETTING	
Weighing Method	Auto
Scale 1	Female
Scale 2	Female
Scale 3	Female
Scale 4	Female

Auto
Curve
Auto Turkey

- Define the weighing method: Auto, Curve, Auto Turkey. Curve includes a user-defined curve option and industrial standard curve options.
- Define each scale as female or male.
- Auto or Auto Turkey Curve
- Customized/Industrial Standard Curves

### 6.3.1 AUTO OR AUTO TURKEY CURVE

- Go to Scale > Bird Weight.
  - If you selected Auto or Auto Turkey in Bird Scale, edit the weights as required. The weight is automatically adjusted.

BIRD WEIGHT	
Current Female Weight	0.09
Current Male Weight	0.09

- If you selected Curve in Bird Scale, edit the curve as required.

BIRD WEIGHT		
Day	Female	Male
0	0.00	0.00
7	0.00	0.00
14	0.00	0.00
21	0.00	0.00
28	0.00	0.00

### 6.3.2 CUSTOMIZED/INDUSTRIAL STANDARD CURVES

1. Go to Scale > Bird Weight > Help.

SYSTEM PARAMETERS	
<b>Female</b>	
Curve Offset	0.00
Select Curve	Ross308Fe
<b>Male</b>	
Curve Offset	0.00
Select Curve	Ross308Ma

2. For female and male, enter the factor used to adjust the weight curve. This amount is added to the Reference weight field. Range: 0.0 – 10.0 Kg/Lb.
3. For female and male, select the required curve from the drop-down list.
4. Go to Scale > Bird Weight.

BIRD WEIGHT		
Day	Female	Male
0	0.09	0.09
1	0.14	0.14
2	0.16	0.16
3	0.20	0.20
4	0.24	0.24

- If you selected Custom, you can edit the curve.
- If you selected an industrial standard curve, the curve is read only.

## 6.4 Silo Setting

These settings help you monitor your silo through weighing. There are two events that take place, emptying (feeding) and filling (loading).

*NOTE Silos must be defined in Scale Layout for the following parameters to be functional.*

SILO SETTING	
Minimum Filling Weight	2000
Filling Detection Weight	300
Resume Time (minute)	5

- **Minimum Filling Weight (Default: 2000 Kg):** Define weight required to be filled during loading to be recorded in **History – Feed**; **History – History View**; **Scale – Feed Conversion**.
- **Filling Detection Weight (Default: 300 Kg):** Define the weight you want your controller to detect a filling to stop augers.
- **Resume Time (minute) (Default: 5 min.):** Once loading is completed, define the time you want your controller to count down for the augers to resume normal operation.

The following is a typical scenario:

A loading truck will come to fill the bin or silo. Define the **Filling Detection Weight** to stop the augers from operating during a loading event (Default: 300 Kg). Next, a **Minimum Filling Weight** needs to be defined in order to have the filling event recorded in the **Feed Inventory** (Default: 2000 Kg). Once the loading of the feed is finished, the timer begins to count down for the augers to resume normal operation (**Resume Time**, Default: 5 minutes) and for the filling event to be recorded as completed.

## 6.5 History

The scale history shows bird weight statistics. You can review daily data for each scale, or separately.

HISTORY									
Day	Avg.	D.Gain	Unif.	No.	Scale1	D.Gain	Unif.	No.	
1	0.00	0.00	0.00	0.00	0.00		0.00	0.00	0.00
2	0.00	0.00	0.00	0.00	0.00		0.00	0.00	0.00
3	0.00	0.00	0.00	0.00	0.00		0.00	0.00	0.00

- The D. Gain shows difference between the current average weight and the previous day's average weight; the data comes from all the scales.
- No daily gain is shown for individual scales.

## 6.6 Feed Conversion

This screen displays the amount of feed converted into the bird's weight.

*NOTE Only Broiler/Layers Mode supports this function.*

FEED CONVERSION			
Day	Bird Weight	Daily Feed	Feed Conversion
17	0.00	0	N/A
18	0.00	0	N/A
19	0.00	0	N/A
20	0.00	0	N/A
21	0.00	0	N/A
22	0.00	0	N/A
23	0.00	0	N/A
24	0.16	0	0.00
25	0.00	0	N/A
26	0.00	0	N/A

## 6.7 Test

*NOTE Users employing Version 6.17 and below, refer to Appendix D: Previous Version Functions, page 181.*

This section is a real timetable to show the statuses of all scales connected to the controller. Make sure that all statuses are O.K. If any of them show a different status, the scale is not installed properly. Unused positions can also show O.K.

1. In *Scale > Scale Layout* (refer to page 104), select the required scale types.
2. In *Scale > Test*, test the scales as required.

TEST			
Ch	A/D	Weight	Status
Silo 1	2024	0.222	O.K.
Silo 2	2010	0.240	O.K.
Feed Scale 1	2024	0.200	O.K.
Silo 3	2011	0.240	O.K.
Scale 1	2000	0.222	O.K.
Scale 2	2024	0.222	O.K.

## 6.8 Calibration

This menu calibrates the scales and silos connected to the controller.

1. In *Scale > Scale Layout* (refer to page 103), select the required scale types.
2. In *Scale > Calibration*, calibrate the scales.

**CAUTION** Do not use scales while calibrating.

### 6.8.1 SCALE CALIBRATION

1. Follow instructions on the bottom section of the screen.
2. Wait until the progress bar displayed shows 100%.
3. Place a known weight on the scale and enter its weight.
4. Wait until the calibration progress bar reaches 100%.
5. Ensure “Good Calibration.”

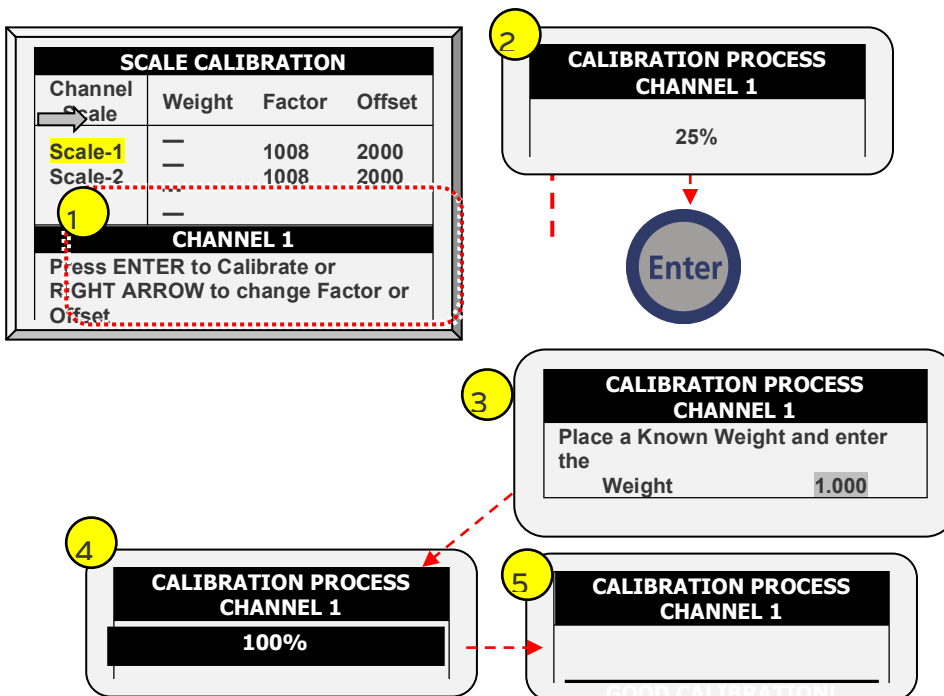

### 6.8.2 SILO CALIBRATION

1. Follow instructions on the bottom section of the screens.
2. Wait until the progress bar displayed shows 100%.
3. Place a known weight or start filling the silo.
4. Wait until the calibration progress bar reaches 100%.
5. Ensure “Good Calibration.”

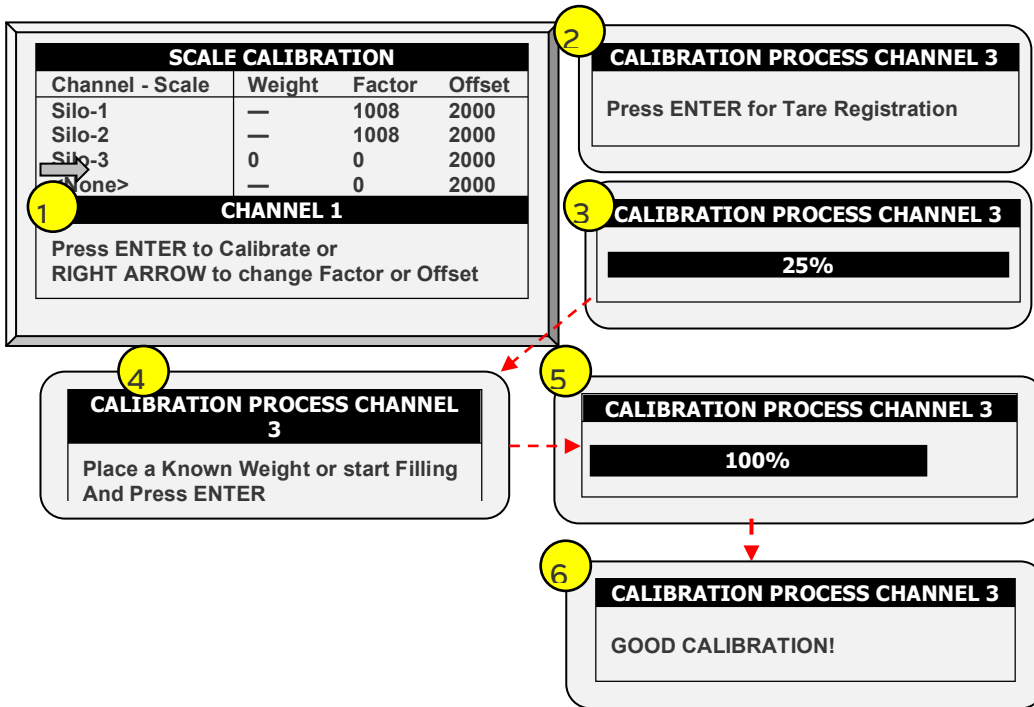

## 6.9 Silo / Auger Layout

This menu maps augers to a specific silo. Map up to four augers to four silos (one each).

*NOTE Only Broilers/Layers mode supports this function.*

SILO/AUGER LAYOUT	
Silo	Auger
1	Auger-1
2	Auger-2
3	None
4	None

*NOTE: Define the silo channel in Scale Layout, page 103.*

*NOTE: Define the feeding schedule in Water & Feed, page 70.*



# 7 History Menu

In the History Menu you can view data regarding:

- Temperature
- Humidity
- CO2
- Water
- Feed
- Mortality
- Heaters
- Radiant Heaters
- Variable Heaters
- Alarms
- Table of Events
- History View
- Power Consumption
- Ammonia History
- Dosing History
- Cool Pad

HISTORY
1. TEMPERATURE
2. HUMIDITY
3. CO2
4. WATER
5. FEED
6. MORTALITY
7. HEATERS
8. RADIANT HEATERS
9. VARIABLE HEATERS
10. ALARMS
11. TABLE OF EVENTS
12. HISTORY VIEW
13. POWER CONSUMPTION
14. AMMONIA HISTORY
15. DOSING HISTORY

## 7.1 Temperature

The temperature history menu stores minimum, average and maximum temperatures by growth day. The average is weighted, so if most of the day has been warm the average is closer to the maximum than the minimum.

## 7.2 Humidity

The humidity history menu stores minimum, average and maximum inside humidity by growth day. The average is weighted, so if most of the day has been humid the average is closer to the maximum than the minimum.

*NOTE If two humidity sensors are installed, this screen displays their average. The History View display shows reading of both sensors only if they have been selected for logging.*

## 7.3 CO2

The CO2 history menu stores minimum, average and maximum inside CO2 levels by growth day. The average is calculated, therefore if most of the day has high CO2 levels the average is closer to the maximum than the minimum. If two sensors are installed (Version 6.20) data points show the average of both sensors.

## 7.4 Water

The water menu records daily water consumption and shows the daily differential change from the previous day in percentage. Verify that the water monitor digital inputs are connected. Monitor up to two drinking water meters, total drinking water, total water, cool pad, fogger, and cool pad flush consumption. In Version 6.23, the user can monitor the water per bird.

WATER					
Day	Total Water Daily	Water/Feed Rate	Water P.bird	Water-1	Water-2
1			0.0 (%)	0.0 (%)	0.0 (%)

The screen displays the:

- Total amount of water consumed
- Water/Feed Rate: Daily water consumption divided by daily feed intake
- Water per bird
- Daily percentage change

## 7.5 Feed

The feed menu records daily feed consumption and shows the daily differential change from the previous day in percent for silos or fill systems.

- ☛ You must install a feed silo weighing system to use the feed system or to monitor the auger system.

The feed data can be based on one of the following inputs. If more than one input is installed, priority is according to the order of the bulleted list.

- **Silo:** If silos (load cells) are installed, feed consumption data of each bin is based on the silo weight.
- **Current Sense:** If Current Sense Relays for Augers are installed and calibrated (refer to Current Sense Relay Calibration, page 133), feed consumption data of each auger is based on the current sense, calculation method settings, and actual auger run-time. The run-time is calculated based on the measured current, when the actual current is higher than the nominal value (refer to Relay Current, page 99).
- **Feed Count:** If a feed count sensor is installed feed consumption for each feed count input is based on the feed count method settings (refer to Digital Sensors, page 142).

As an option, the user can monitor the feed per bird.

1. Go to History > Feed > Help.
2. Enable Display History Per Bird.

WATER				
Day	Total Daily	(%)	Feed Per Bird	Feed -1 Daily (%)
1	12		0.000	
2	12		0.000	
2				

*NOTE When the weight is set to Metric, the feed per bird is accurate to three decimal points (Pigs Mode does not support this function).*

## 7.6 Mortality

The mortality history menu maintains daily summaries of mortality, cull, and total dead. It also shows the percentage dead and gives an updated count of bird inventory. The history is maintained separately for male, female and total. Use the left and right arrow keys to switch to the next screen.

## 7.7 Heaters

The Controller maintains daily total run times of each heater. The table fills several screens; to view the off-screen data, use the arrow keys to scroll. The data is in hours:minutes format.

## 7.8 Radiant Heaters

The Controller maintains daily total run times of each radiant heater, including separate data for low level and high-level heaters. The table fills several screens; to view the off-screen data, use the arrow keys to scroll. The data is in hours:minutes format.

## 7.9 Variable Heaters

The controller tracks the operating time of the variable heaters. The table fills several screens; to view the off-screen data, use the arrow keys to scroll. The data is in hours:minutes format.

## 7.10 Alarms

The alarm history records the growth day and time of each alarm. Alarms that are currently active show up as flashing on the screen. Alarm history is not reset when using *Management, Growth Date & Flock > New Flock*. The last 250 alarms are saved, and as the table is filled, new alarms push out the older alarms.

## 7.11 Table of Events

The Controller records significant events with growth day and time stamp. The Table of Events is 1000 events long and is not reset when using *Management, Growth Date & Flock > New Flock*. New events push out the older events.

Typical events recorded are switch changes, entry into tunnel mode, natural or minimum ventilation, alarm resets, ventilation mode changes and more. The Table of Events is an excellent tool to determine whether your controller is going in and out of tunnel due to marginal settings as well as finding and identifying problems.

*NOTE Go to the Table 4, page 152 to view all the available events.*

## 7.12 History View

The History View menu has detailed history on a variety of sensors and data. Go to *Help > Set* under History View to select the particular data to collect.

1. In *Install > Setup > History Resolution*, set the frequency of your data collection. Factory default collects one-hour data on a selection from the choices below.
2. Under *Help | Graph* you can select a variety of graphs of the detailed history.
3. In the **HISTORY VIEW | HELP | SET** menu, set the desired choice by using the '+/-'.

The options are as follows:

- Target Temp.
- House Temperature: Minimum, Average and Maximum
- Temp – 1-9: Minimum, Average and Maximum
- Attic Sensor: Minimum, Average and Maximum
- Outside Temperature: Minimum, Average and Maximum
- Humidity In/Out: Minimum, Average and Maximum
- Water Consumption
- Feed Consumption
- Level of Ventilation

*NOTE* Altering choices erases old data and starts a fresh data set.

## 7.13 Power Consumption

This menu displays the daily power consumption (in kWh) of the heaters, fans, lights and other equipment and the change from the previous day.

*NOTE* Current sense relays are required for this function to be enabled (*single phase electricity only*).

## 7.14 Ammonia History

This screen displays the minimum, average, and maximum ammonia levels, by growth day.

## 7.15 Dosing History

This screen displays the date, total work time, water volume transmitted, and total volume of dosage material added. Because the type of additive can be changed, the controller records each additive's history separately.

- Version 6.22: Scroll right and left to view the history of each particular pump.

## 7.16 Cool Pad

This screen displays the cool pads' running time. The screen displays up to six units, but only shows the running time of cool pads mapped in the Relay Layout menu.

# 8 Test Menu

The Test Menu screen shows internal information in order to verify that the Controller is operating correctly. Moreover, it can help find broken wires or any other problems related to it.

- Switches & Relays, page 117
- Alarm, page 118
- Analog Sensors, page 118
- Digital Sensors, page 119
- Analog Output, page 119
- Static Pressure, page 119
- Communication, page 120
- Hardware Checklist, page 120

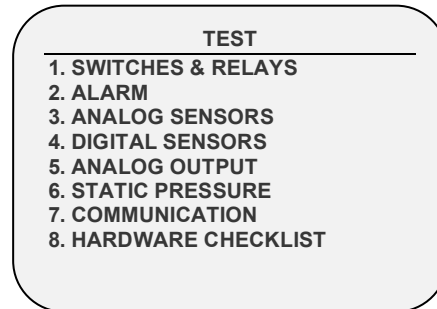

## 8.1 Switches & Relays

This menu displays a screen of identified switches and relays installed in the controller. Use this option to determine faulty hardware.

- The Platinum Pro supports a maximum of 30 relays.
- The Rotem Pro supports a maximum of 50 relays.

The following screen illustrates a system having 80 switches and relays.

SWITCHES & RELAYS									
01	02	03	04	05	06	07	08	09	10
Aut	Aut	Aut	Aut	Aut	Aut	Aut	Aut	Aut	Aut
11	12	13	14	15	16	17	18	19	<b>20</b>
Off	Off	Aut	Aut	Aut	Aut	Aut	Aut	Aut	Aut
21	22	23	24	25	26	27	28	29	30
Aut	Aut	Aut	Aut	Aut	Aut	Aut	Aut	Aut	Aut
31	32	33	34	35	36	37	38	39	40
On	Aut	On	Aut	Aut	Aut	Aut	Aut	Aut	Aut
41	42	43	44	45	46	47	48	49	50
Aut	Aut	Aut	Aut	Aut	Aut	Aut	Aut	Aut	Aut
51	52	53	54	55	56	57	58	59	60
Off	Off	Aut	Aut	Aut	Aut	Aut	--	--	--
61	62	63	64	65	66	67	68	69	70
--	--	--	--	--	--	--	--	--	-
71	72	73	74	75	76	77	78	79	80
--	--	--	--	--	--	--	--	--	--

## 8.2 Alarm

Press Enter to toggle the Alarm Relay.

- ON means alarms are functioning.
- OFF means alarms are not functioning.

Note that the alarm relay is powered for the 'NO ALARM' condition to provide automatic Power Fail Alarm in case of power failure to the controller. That is, the Normally Open side is closed during NO ALARM.



## 8.3 Analog Sensors

Observe the converter readings for analog sensors with this menu.

The screenshot shows a terminal window with the following table:

ANALOG IN TEST			
In.	Sensor	A/Value	
<b>CARD 1</b>			
1	Temp. Sensor 1	470	64.0
2	Temp. Sensor 2	426	87.2
3	Temp. Sensor 3	470	85.6
4	Temp. Sensor 4	426	82.0
5	Temp. Sensor 5	470	87.0
6	<None>		
7	<None>		
8	<None>		
9	<None>		
10	<None>		

Box 1      Card 1      Slot 3      Channel 1

The readings can vary from 0 to 1023. The values displayed in the 'Value' column indicate that the analog sensor is operating or not according to the following:

- If a very large value is shown (such as a four-digit number) or a small value is shown (such as a one-digit number): sensor is **not connected**.
- If the unit displays a 3-digit number, usually beginning with the digit '4': sensor is **operating**.

## 8.4 Digital Sensors

This screen displays the digital sensors' states.

DIGITAL IN TEST			
In.	Sensor	State	Counter
<b>CARD 1</b>			
1	Water Meter 1	1	0
2	Water Meter 2	0	0
3	Fogger Water Meter	0	0
4	AUX. Alarm	0	0
5	AUX. Alarm	0	0
6	Low Water Pressure	0	0
7	Wind Speed	0	0
8	<None>	0	0
Box 1	Card 1	Slot 3	Channel 1

A '1' implies a shorted input, a '0' an open input. The digital sensors operate with dry contact inputs such as the Arad Water Meter, or micro-switches.

You can apply a short/open input to each channel; the response is then displayed.

*NOTE The water meter quantities appear on the main screen or on Hot Screen 0.*

## 8.5 Analog Output

This screen tests light dimmers, variable speed fans, and variable heaters.

1. Scroll to the required output.
2. Enter the test voltage and verify that the device is operating.

ANALOG OUT TEST		
Output.	Sensor	0 – 10v
<b>CARD 1</b>		
1	Light Dimmer 1	0.0
2	Light Dimmer 2	0.0
3	Light Dimmer 3	0.0
4	Var. Heat	0.0
5	W.O.D	0.0
6	<None>	0.0
7	<None>	0.0
8	<None>	0.0
Box 1	Card 1	Slot 3 Channel 1

## 8.6 Static Pressure

Observe the converter readings for the static pressure sensor. The nominal 'zero' pressure reading is 130. Remove the air hoses from the brass connectors on the left side outside of the controller to check this reading.

STATIC PRESSURE	
A/D Counts	126

## 8.7 Communication

This menu facilitates testing on communication networks. A multiplexer in loopback mode is used to test communication. The Controller follows its' own communication to check for failed hardware. Follow the instructions displayed on the screen.

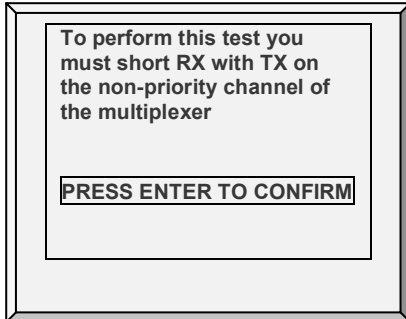

## 8.8 Hardware Checklist

Check the installed hardware that has been identified by the Plug and Play system. The system detects all cards except communication. The standard optional communication card provides lightning protection and does not have local computerized intelligence to identify itself to the system. Note that if a card is missing, turn the power OFF and then ON for a card rescan.

HARDWARE CHECKLIST				
Card	Box	Slot	Status	Chann.
<b>Analog In</b>				12
Analog In 1	1	2	OK	12
<b>Digital In</b>				12
Digital In 1	1	1	OK	12
<b>Analog Out</b>				10
Analog Out 1	1	3	OK	10
<b>Scales</b>				0
SCALE CARD	1	4	OK	6
RSU 1	1	NA	OK	2
RSU 2	1	NA	OK	2
<b>Static Press</b>				0
<b>Alarm</b>				1
Alarm 1				1
<b>Relays</b>				50
N.O. 1	1	1	OK	10
N.O. 2	1	2	OK	10



# 9 Service Menu

The Service Menu items calibrate various Controller functions.

- Temperature Calibration, page 122
- Humidity Calibration, page 122
- CO2 Calibration, page 123
- Static Pressure Calibration, page 123
- Light Sensor Calibration, page 125
- Feed Calibration, page 125
- Water Calibration, page 126
- Ventilation Potentiometer Calibration, page 126
- Nipple Flushing, page 126
- Feeders & Drinkers, page 128
- Save Settings, page 130
- Load Settings, page 131
- Current Sense Relay Calibration, page 133
- Wind Direction Calibration, page 134
- WOD Calibration, page 134
- Ammonia Calibration, page 135



Figure 19: Broilers Service Menu

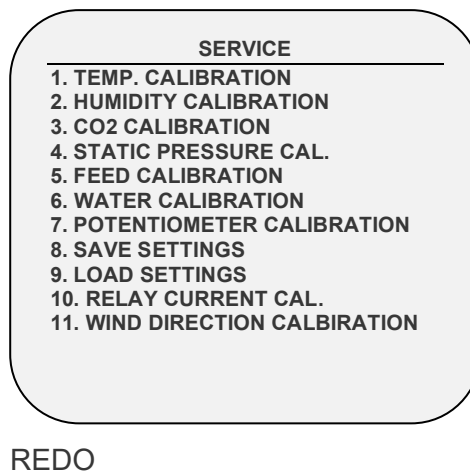

Figure 20: Layers Service Menu

## 9.1 Temperature Calibration

The Controller temperature sensors are typically accurate to approximately 0.5° F within the range of temperatures for poultry production. Calibrate them in this menu by adding/subtracting a constant correction factor to each sensor. Adjust the sensor of your choice with the left/right arrow keys.

TEMPERATURE CALIBRATION		
Sensor	Temp°	Factor
1	78.2	1.6
2	86.4	0.9
3	83.0	-1.5
4	86.2	0.8
5	85.2	-1.6
6	84.2	0.0

Calibrating against infrared or in air temperature sensors generally results in less accuracy than the basic sensors have without calibration.

**CAUTION** Only calibrate the sensors if you have reason to believe that they are producing inaccurate results.

To calibrate the sensor:

1. Obtain an accurate reference sensor and a pail of water at the approximate required temperature.
2. Stir the reference sensor together with the Controller sensor vigorously in the bucket of water. Keep your hands off the sensor itself, so that it responds accurately to the water temperature. Stirring is necessary to preclude stratification within the bucket of water.
3. Call out the accurate reading to a second person standing at the Controller. Walkie-talkie radios may be a good idea.
4. The individual at the controller should double-check that you are calibrating the correct sensor. You might warm/cool the sensor temporarily to see which sensor changes temperature appropriately.
5. Once you determine the correct temperature and allow approximately one minute for stabilization in the water, adjust the sensor reading at the controller.
6. Offset the factor using the left/right arrow keys.
  - Refer to Temperature Curve, page 19.

## 9.2 Humidity Calibration

To calibrate the humidity level, obtain a suitable humidity test kit and use the procedures described there. They are commonly available via the Internet.

**CAUTION** Only calibrate the sensors if you have reason to believe that they are producing inaccurate results.

HUMIDITY CALIBRATION		
Sensor	Humidity°	Factor
In	58.9	2.3
Out	N/A	---

Press Left/Right Arrows to Calibrate

- Adjust the Controller reading as needed using the left/right arrow keys.
- Refer to Humidity Treatment, page 29.

### 9.3 CO2 Calibration

To calibrate the CO2 level, obtain a suitable test kit and use the procedures described in the kit. Ensure that the house is well ventilated, either naturally or using fans.

**CAUTION** Only calibrate the sensors if you have reason to believe that they are producing inaccurate results.

CO2 SENSOR CALIBRATION	
	Value
PPM at 4 mA/1 VDC	26
PPM at 20 mA/5 VDC	3000
Factor (PPM)	22

CO2 (ppm): 482

CO2 SENSOR CALIBRATION	
CO2 - 1	
PPM at 4 mA/1 VDC	26
PPM at 20 mA/5 VDC	3000
Factor (PPM)	22
CO2 - 2	
PPM at 4 mA/1 VDC	26
PPM at 20 mA/5 VDC	3000
Factor (PPM)	22

CO2 -1 (ppm): 1243  
CO2 -2 (ppm): 1218

Figure 21: CO2 Calibration, Version 6.19 and below

Figure 22: CO2 Calibration, Version 6.20 (if two sensors are defined in Analog Sensors, page 141)

- Ppm at 4 mA / 1 VDC: Parts per million for 4 mA or 1 VDC
- Ppm at 20 mA / 5 VDC: Parts per million for 20 mA or 5 VDC
- Factor (ppm): (-/+ ) ppm shift from the current reading. Correct the sensor reading by editing this factor. The controller saves this data.
- CO2 (ppm): Current CO2 readings
- if there is no value to display, N/A appears. Adjust the Controller reading as needed using the left/right arrow keys.
- Refer to CO2 Treatment, page 31.

### 9.4 Static Pressure Calibration

The Static Pressure should be 0 when there is no ventilation and the house is closed. When the controller A/D counts is 100, this means that there is zero (0) static pressure.

**CAUTION** The Static Pressure sensor is factory calibrated. Only calibrate the sensor if you have reason to believe that they are producing inaccurate results.

**NOTE:** Run the controller for a few hours so that the temperature in the box becomes stable and only then calibrate.

**CAUTION** DO NOT blow the air into the hose to see if the pressure changes! The sensor is sensitive and blowing air can cause irreparable damage.

To calibrate the Static Pressure Sensor:

1. Disconnect the air hoses.
2. Go to *Service* > *Static Pressure Cal.*
3. If the A/D count is 100 +/- 30 (70 to 130), press Enter.
4. If the A/D count is less than 70 or greater than 130:
  - a. Check for blocked air hoses or wind interference.
  - b. Adjust the zero-pressure reading to approximately 100 by turning the calibration screw.
  - c. When the A/D count is within the permitted range, press Enter.

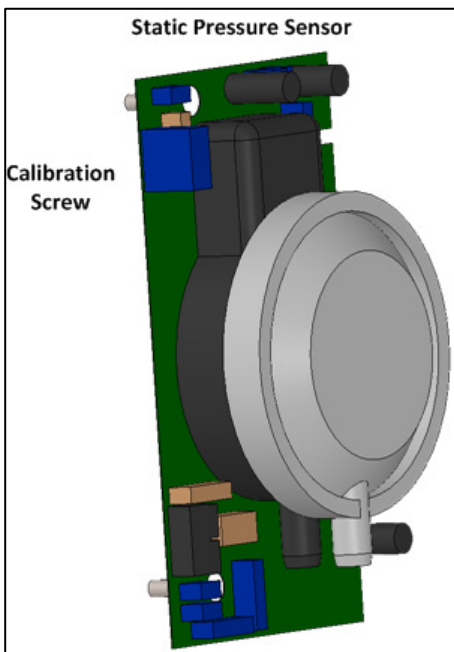
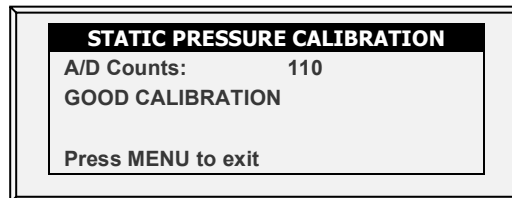
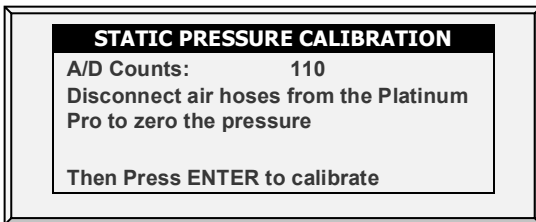

- Refer to Static Pressure, page 39.

## 9.5 Light Sensor Calibration

*NOTE Broilers/Layers mode supports this feature.*

Installing a light sensor enables turning off the lights when there is sufficient outside light.

To calibrate the light sensor:

1. Go to *Install > Analog Sensors* (page 141).
2. Define one sensor as a light sensor.
3. Go to *Device > Light* (page 66).
4. Press **Help**, highlight **Set**, and press **Enter**.
5. Scroll down to **Light Sensor Active** and set to **Yes**.
6. Place the sensor in the required location.
7. Go to *Service > Light Sensor Calibration*.
8. When the outside light is bright enough, press **Enter**.

## 9.6 Feed Calibration

Platinum Pro/Rotem Pro can use silo scales or less expensive digital monitoring devices to keep track of your feed. This menu calibrates the digital monitoring devices.

1. Select the feed counting method. Your digital monitoring device may generate a dry contact pulse for each quantity of feed, or it may simply indicate that the feed is running.
2. Enter the quantity of feed per pulse in case you use a dry contact pulse. Otherwise, enter the amount of feed delivered per minute of auger operation.
3. Select one of the following:
  - **Pulse:** Weight per pulse
  - **Time:** Weight per minute
  - **Current Sense:** Motor run time when the auger contains feed
4. Enter quantity (weight per minute or per pulse).

FEED CALIBRATION				
Feed	1	2	3	4
Method	TIME	TIME	TIME	TIME
Factor	2.203	2.203	2.203	2.203

Method Pulse: Weight per Pulse  
Method Time: Weight per Minute  
Method Current: Weight per Minute

## 9.7 Water Calibration

The controller supports up to four dry contact pulse output water meters. Enter the quantity of water per pulse for your water meters.

WATER CALIBRATION			
Water 1	-	Water Per Pulse	0.100
Water 2	-	Water Per Pulse	0.100
Water 4	-	Water Per Pulse	0.100
Water 4	-	Water Per Pulse	0.100
Cool Pad	-	Water Per Pulse	2.203
Fogger	-	Water Per Pulse	2.203

## 9.8 Ventilation Potentiometer Calibration

Use this screen to calibrate the ventilation potentiometer control. Potentiometer calibration is required before ventilation can be controlled via a potentiometer.

POTENTIOMETER CALIBRATION				
Pot	Device	Close	Current	Open
1	Vent 1	152	0	1000
2	Vent 2	152	0	1000

### ➤ Before calibrating the potentiometers:

- Disable the static pressure unit in *Install > Setup* (page 138).
- Define at least one relay as vent/inlet/tunnel in *Install > Relay Outlet* (page 139).
- Define at least one analog sensor as a potentiometer in *Install > Analog Sensor* (page 141).

1. Select a potentiometer number.
2. Press Enter.

The device relay closes and then opens. As this takes place, the numbers in the Close, Current, and Open columns change. After a few minutes, the process completes and a "Good Calibration" message appears.

*NOTE After potentiometer calibration, the times displayed in the Vent/Curtain Setup screen change. Refer to Vent & Curtain Levels, page 55 for details.*

## 9.9 Nipple Flushing

*NOTE Broiler Mode supports this function.*

- Nipple Flushing (Standard)
- Nipple Flushing Help | Set Definitions
- Nipple Flushing by Temperature

### 9.9.1 NIPPLE FLUSHING (STANDARD)

To use this selection, program the water solenoids using the following relay codes:

- 111 Water Main: The control's supplementary for the usual water line
- 112 Water Bypass: The control's supplementary to bypass the water pressure regulator
- 113 Water line 1 through 122 Water line 10: Individual water line supplementary to select the line to flush

During normal operation, only relay 111 water main is active. During flushing relay, code 112 is active together with each of the individual water line relays in turn.

- Configure up to 20 flush times.
- Set start time/duration of water flushing (water lines as defined by relay layout)

NIPPLE FLUSHING		
Start Time	On Time (min)	Status
06:00	2	AUTO
15:40	1	AUTO
00:00	0	AUTO
00:00	0	AUTO
00:00	0	AUTO

### 9.9.2 NIPPLE FLUSHING HELP | SET DEFINITIONS

① While viewing the Nipple Flushing menu: Press **HELP**, select **SET** and press **ENTER**.

FLUSH ORDER							
Line:	1	2	3	4	--	--	--
Order:	1	2	3	4	--	--	--

FLUSHING DAYS							
Day:	Sun	Mon	TUE	WED	THU	FRI	SAT
Flush:	▪	√	√	▪	▪	▪	▪

- Flush Order: Set flushing according to line/order
- Flushing Days: Set flushing per day using '+'/'-' key

### 9.9.3 NIPPLE FLUSHING BY TEMPERATURE

Version 6.20 supports nipple flushing by temperature, in which the flushing only takes place when the water temperature in the pipes reaches a certain temperature. This function requires one water temperature sensor per house:

- Water Temperature Sensor PTC:
  - 1V (4 mA) = -40° C
  - 5V (20 mA) = 60° C
- Munters Water Temperature Sensor

*NOTE Refer to the Installation Manual for details on installing these products.*

To configure nipple flushing by temperature:

1. In Installation > Analog Sensor, define one sensor as Water Temp PTC and one sensor as Water Temp NTC.
2. In Installation > Relay Layout, define the required number of relays as Water Line.
3. Go to Service > Nipple Flushing. Note the flushing temperature appears on the main screen.

NIPPLE FLUSHING		
Start Time	On Time (min)	Status
06:00	2	AUTO
15:40	1	AUTO
00:00	0	AUTO
00:00	0	AUTO
00:00	0	AUTO

Water Temperature: 21.9

4. Go to Service > Nipple Flushing > Settings.

NIPPLE FLUSHING	
Water Temp to Flush	30.0
Flushing Time Duration (min)	1
Flushing Delay (min)	120
Flush Before Sunrise	YES
FLUSH ORDER	
Line:	1 2 3 4 -- -- --
Order:	1 2 3 4 -- -- --
FLUSHING DAYS	
Day:	Sun Mon TUE WED THU FRI SAT
Flush:	▪ √ √ ▪ ▪ ▪ ▪

5. Define:

- Water Temp to Flush: Water temperature at which flushing begins.
- Flushing Time Duration (min): Default 1 minute. Range: 0 - 250
- Flushing Delay (min): Default 120. Range: 1 - 999
- Flush Before Sunrise: Yes or No. Day is defined as when the light intensity reaches 70% of the intensity in the Light Table (refer to Light, page 66).

*NOTE These parameters appear even if water temperature sensors are not installed, but in that situation they are irrelevant.*

## 9.10 Feeders & Drinkers

This selection enables inserting relevant information regarding feeder and drinker lines.

- Version 6.18 or below: Define at least one of the following pairs:
  - Feed Line Up/Down
  - Feeder Window Open/Close
  - Drink line Up/Down
- Version 6.19: Define at least one of the following relays (a pair is not required):
  - Feed Line Up/Down



- Feeder Window Open/Close
- Drink line Up/Down

### 9.10.1 FEEDERS & DRINKERS MAIN SCREEN

FEEDERS AND DRINKERS			
Day	Window Pos (%)	Feeder-Line Lift (inch)	Drinker-Line Lift (inch)
15	90	0.0	14.0
20	50	15.0	3.0
0	0	0.0	0.0
0	0	0.0	0.0
0	0	0.0	0.0
0	0	0.0	0.0
0	0	0.0	0.0

- Day: Insert day number.
- Window Pos (%): Insert the percentage of window's position.
- Feeder-Line Lift (Inch): Define the specific feed line lift, measured in inches.
- Drinker-Line Lift (Inch): Define the specific drinker line lift, measured in inches.

### 9.10.2 FEEDERS & DRINKERS HELP | SET DEFINITIONS

- ② While viewing the Feeders and Drinkers menu: Press **HELP**, select **SET** and press **ENTER**.

FEEDERS AND DRINKERS	
Adjust At Time	12:00
<b>FEEDER WINDOW</b>	
Stop Feed Before Adjust (Min.)	60
Time From Close To Open (sec)	15
<b>FEED LINE</b>	
Movement Time Per 10 inch (sec)	0
<b>DRINKERS LINE</b>	
Movement Time Per 10 inch (sec)	0

- Adjust at Time: Set the desired time to adjustment.

#### Feeder Window

- Stop Feed Before Adjust (min): Set the amount of time to stop feeding before adjustment begins.
- Time from Close to Open (sec): Set the amount of time after stopping the feeding before opening the feeder's window.

#### Feed Line

- Movement Time per 10 inch (sec): Set a number of seconds needed to move the feed line 10 inches.

## 9.11 Save Settings

The method used to save the controller's settings to an external memory device is dependent on the hardware employed.

*NOTE If both a data plug and SD card are inserted, the data plug takes priority and that option appears on the screen.*

- Saving to a Data Plug
- Saving to an SD card

### 9.11.1 SAVING TO A DATA PLUG

This menu enables the user to save his program settings to the supplied data plug and transport them to another controller for quick programming.

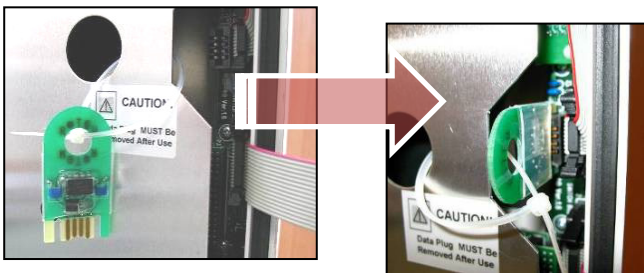

1. Insert data plug as shown.
2. Save controller settings.

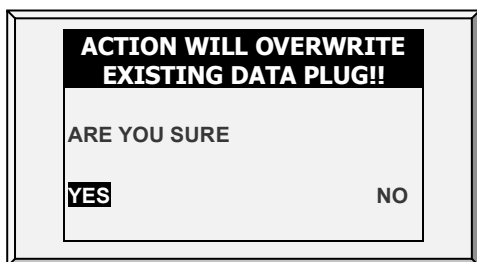

### 9.11.2 SAVING TO AN SD CARD

This menu enables the user to save the program settings to an SD card and transport them to another controller.

*NOTE Verify that the SD card is in the "Unlocked" position (see the following illustration). The card must be in the Unlocked position to enable software upgrades.*

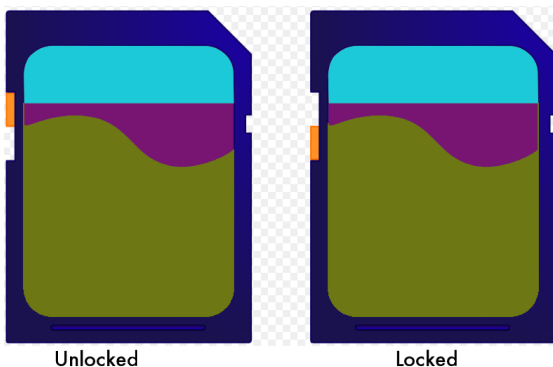

*NOTE If both a data plug and SD card are inserted, the data plug takes priority and that option appears on the screen.*

- Verify that the SD card is in place.
- The SD card must have at least 20K of free space.

To save settings:

1. Go to Service > Save Settings.
2. In the screen that appears, select YES and press Enter.
3. Select the required settings and press Enter.
4. Wait for the settings to download.

SAVE TO SD CARD		
1. Setting #1	8-Jan-13	12:00
2. Setting #1	15-Jan-13	12:00
3. Setting #1	23-Mar-13	12:00
4. Setting #1	15-Jun-13	12:00
5. Setting #1	15-Nov-13	12:00
6. Setting #1	01-Jan-14	12:00

## 9.12 Load Settings

This menu enables reading a saved program from a data plug into the controller quickly and reliably rather than configuring the settings manually.

- Loading from a Data Plug
- Loading from an SD card
- Load Settings Report

### 9.12.1 LOADING FROM A DATA PLUG

- Verify that the program data is identical to the relay layout of the controller.
  - Follow the instructions given on the screen.

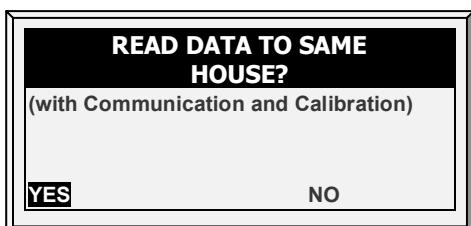
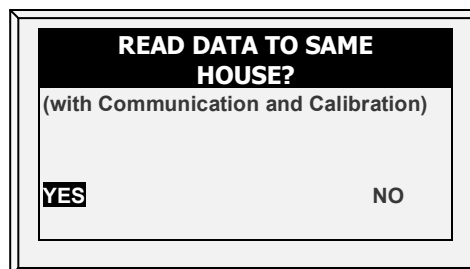
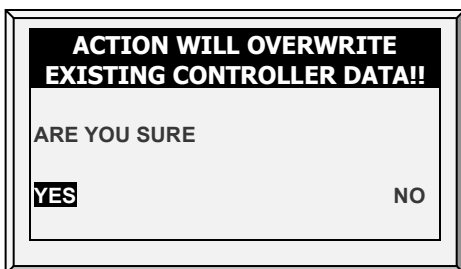

### 9.12.2 LOADING FROM AN SD CARD

This menu enables the user to load settings saved on an SD card into a controller.

*NOTE* If both a data plug and SD card are inserted, the data plug takes priority and that option appears on the screen.

- Verify that the SD card is in place.
- The SD card must have at least 20K of free space.

To load settings:

1. Go to Service > Load Settings.
2. In the screen that appears, select YES and press Enter.
3. Select the required settings and press Enter.
4. Wait for the settings to upload.

READ FROM SD CARD		
1. Setting #1	8-Jan-13	12:00
2. Setting #1	15-Jan-13	12:00
3. Setting #1	23-Mar-13	12:00
4. Setting #1	15-Jun-13	12:00
5. Setting #1	15-Nov-13	12:00
6. Setting #1	01-Jan-14	12:00

### 9.12.3 LOAD SETTINGS REPORT

*NOTE* Version 6.19 and above supports this function.

When uploading settings to a controller, Platinum Pro/Rotem Pro lists which tables (if any) will not be transferred. Compatibility issues might arise in cases when transferring settings between controllers using different software versions or having different configurations. By listing which tables will not transfer, the user knows which tables must be defined manually.

1. Go to Service > Load Settings.
2. In the screen that appears, select YES and press Enter.
3. Select the required settings and press Enter.
4. If there are any incompatible tables, a list of the pathways appears.

LOAD SETTINGS REPORT
The following tables can't be uploaded.
Install > Light Dimmers
Device > Light
Device > Light > Set
Scale > Scale Layout
Press MENU to Continue

5. Press Menu. The following message appears:

LOAD SETTINGS REPORT
Do you want to proceed with the procedure?
YES    NO

6. To proceed, select YES.

- After loading the settings and resetting the controller, a record of incompatible tables can be viewed in Table of Events (page 115). Note that pathway is shown using a number to indicate the menu.

TABLE OF EVENTS			
	Event	Day	Time
20	Tunnel Ventilation	2	1:15:50
21	Minimum Ventilation	2	1:30:43
22	8. Light Dimmers	2	4:14:44
23	2. Light	2	4:14:44
24	2. Light / Set	2	4:14:44
25	4. Scale Layout	2	4:14:44
26	Data Read From Plug	2	4:14:44

### 9.13 Current Sense Relay Calibration

*NOTE The Current Sense relays support single phase electricity only.*

This menu calibrates the amount of current that passes through Current Sense relays. Calibration enables configuring the minimum and maximum permissible currents.

To calibrate the current sense relay:

1. Define the relay.
2. Select *Service > Relay Current Cal.* The following screen appears.

RELAY CURRENT CALIBRATION			
Relay	Function	Measure	Current
			ON
31	Heat 6	Start	0.0
32	Heat 7	Start	0.0
33	Heat 8	Start	0.0
34	Exh. Fan 5	Start	0.0
35	Exh. Fan 6	Start	0.0

**Warning!!!**  
The selected equipment will be turned ON now for current reading adjustment WAIT till operation completion for 15 sec  
Verify that the relay switch is AUTO

3. Select a relay and click **Enter**.

*NOTE Set the relay to Auto.*

4. Repeat for each current sense relay.

RELAY CURRENT CALIBRATION			
Relay	Function	Measure	Current
			ON
31	Heat 6	Done	0.2
32	Heat 7	Done	0.2
33	Heat 8	Done	0.2
34	Exh. Fan 5	Done	3.8
35	Exh. Fan 6	Done	4.3

**Warning!!!**  
 The selected equipment will be turned ON now for current reading adjustment WAIT till operation completion for 15 sec  
 Verify that the relay switch is AUTO

5. To set the minimum and maximum voltages, alarms and 110/220 voltage, refer to Relay Current, page 99.

## 9.14 Wind Direction Calibration

Use this screen to calibrate a wind direction sensor.

- ➡ Define an analog sensor as wind direction.

WIND DIRECTION CALIBRATION		
	Direction	Calibration
Wind Direction	6	14.50

## 9.15 WOD Calibration

- WOD Main Screen
- WOD Calibration Help | Set Definitions

### 9.15.1 WOD MAIN SCREEN

- ➡ Define an analog sensor as WOD.

WATER ON DEMAND CALIBRATION		
	Volt	Pressure - PSI
WOD 1st Calib.	2.50	14.50
WOD 2nd Calib.	7.50	43.50

**READ ME**

Enter output voltage for first point.  
 Enter water meter measure pressure.  
 Repeat this for the second point.

- In *Installation* > *Setup*, set the Length Unit.
  - Metric = Bar
  - Non-Metric = PSI
- In *Service* > *WOD Calibration*:

- a. Enter the first voltage and check pressure data points.
  - b. Repeat for second data points.
3. Set the Help Definitions (optional)

### 9.15.2 WOD CALIBRATION HELP | SET DEFINITIONS

This parameter reduces the water pressure by a user-defined factor.

SYSTEM PARAMETERS	
<b>WATER ON DEMAND</b>	
Pressure Reducer Factor	50.00

1. In *Install* > *Setup*, define the Pressure unit.
2. In *Service* > *WOD Calibration* > *Help*, define the reduction factor. Water pressure is reduced by 1/50 (bar or PSI). The factor is accurate to two decimal points.

### 9.16 Ammonia Calibration

- Define an analog sensor as ammonia sensor.

To calibrate the ammonia level, obtain a suitable test kit and use the procedures described in the kit. Ensure that the house is well ventilated, either naturally or using fans.

- Only calibrate the sensor if you have reason to believe that they are producing inaccurate results.

AMMONIA CALIBRATION	
PPM at 0VDC	0
PPM at 5VDC	100
Factor (ppm)	0
AMMONIA (ppm) 15	

- Define the following:
  - Ppm at 0 VDC: Parts per million at 0 VDC
  - Ppm at 5 VDC: Parts per million at 5 VDC
  - Factor (ppm): (-/+ ) ppm shift from the current reading. Correct the sensor reading by editing this factor. The controller saves this data.
  - Ammonia (ppm): Current ammonia reading
  - Adjust the Controller reading as needed using the left/right arrow keys.
  - Refer to Ammonia Treatment.

## 9.17 Curtains Calibration

These parameters enable maintaining an accurate curtain position.

CURTAIN CALIBRATION	
<b>CALIBRATION TIME</b>	
From Time	0:00
To Time	0:00
<b>VENTS CALIBRATION</b>	
Number of Steps	0
Power Vents Calibration	NO
<b>NATURAL CALIBRATION</b>	
Number of Steps	0
Proximity to Edge %	10
Close Below This Temp. outside temp	32
<b>POSITION ACCURACY</b>	
Precision Around Target	0

- Define:

### CALIBRATION TIME

- From/To Time: Time period in which calibration is enabled.

### VENTS CALIBRATION

- **Number of Steps:** Number of steps for automatic calibration: Set calibration point for curtain after desired amount of curtain opening/closing (steps). During calibration, if the curtain is open more than 50% it opens to 100%, calibrates, and returns to the previous position. If the curtain is open less than 50% it closes to 0%, calibrates, and returns to the previous position. Default: 99.
- **Power Vents Calibration:** This parameter enables automatic calibration of air inlets when recovering from a power outage. In many installations the backup system, such as Munters' RBU-27, may have opened the air sources. When the Platinum takes over control again, the air inlets are incorrectly positioned. The calibration at power up feature synchronizes the actual position and the controller.

### NATURAL CALIBRATION

- **Number of Steps:** Number of steps for automatic calibration: Set calibration point for curtain after desired amount of curtain opening/closing (steps). During calibration, if the curtain is open more than 50% it opens to 100%, calibrates, and returns to the previous position. If the curtain is open less than 50% it closes to 0%, calibrates, and returns to the previous position. Default: 99.
- **Proximity to Edge %:** Curtain will open or close based on this proximity to the edge. For example, when set to 10%, the curtain closes when the opening is less than 10% and opens completely when the opening is greater than 90%.
- **Close Below This outside temperature:** Curtains close when the outside temperature reaches this point.

- ➔ This parameter requires defining a temperature sensor as an outside sensor (refer to Temperature Definition, page 148)



*NOTE The Proximity to Edge % parameter takes priority over the Close Below This Temp parameter. Meaning, if the outside temperature mandates closing the curtain, the curtains will still open if they are within the proximity defined in the Proximity to Edge parameter.*

### Precision Accuracy

- **Precision Around Target:** Define the band around the opening target. When the vent or curtain reaches this range, it remains in place and no longer attempts to reach the exact opening position.

# 10 Install Menu

The Install Menu items are used when installing input and output devices, as well as configuring critical parameters needed to run your controller properly.

- Setup, page 138
- Relay Layout, page 139
- Analog Sensors, page 141
- Digital Sensors, page 142
- Analog Output, page 143
- Light Dimmers, page 144
- Vent / Curtain Setup, page 144
- Temperature Definition, page 148
- Fan Air Capacity, page 149
- House Dimensions, page 150
- Communication, page 150

INSTALLATION
1. SETUP
2. RELAY LAYOUT
3. ANALOG SENSORS
4. DIGITAL SENSORS
5. ANALOG OUTPUT
6. VENT/CURTAIN SETUP
7. CURTAIN SETUP
8. TEMP DEFINITION
9. FAN AIR CAPACITY
10. HOUSE DIMENSIONS
11. COMMUNICATION

*NOTE If an RLED 2.0 is connected to the Controller, the menu includes "Light Dimmers". Refer to Light Dimmers, page 144.*

## 10.1 Setup

### 10.1.1 SETUP MAIN SCREEN

SETUP	
Ventilation Mode	PRECISION
Language	ENGLISH
Temperature Unit	F°
Static Pressure Unit	IN.W.C
Wind Speed Unit	Meter/Sec
Fan Air Capacity Unit	CFM
Length Unit	NON METRIC
Weight Unit	LB
Growing Zones (1-4)	2
Minimum Vent (Power)	YES
Natural Ventilation	NO
Tunnel	YES
History Resolution	15 MINUTE

Set the following:

- Temperature Unit      Celsius / Fahrenheit
- Static Pressure Unit    Milibar / Inches of WC (Water Column) / Pascal / cm of WC / mm of WC / None
- Wind Speed Unit        Km/hour / Mile/hour / Meter/Sec / Feet/Sec
- Fan Air Capacity Unit    Cubic feet per minute (CFM) / Cubic meter per hour (M3/H)

- Length Unit Meter / Feet
- Weight Unit Pounds (LB) / Kilograms (KG)
- Growing Zones 1/2/3/4
- Minimum Vent (Power) YES (power) / NO
- Natural Ventilation YES / NO
- Tunnel YES / NO
- History Resolution 1 minute / 5 minute / 10 minute / 15 minute / 30 minute / 1 hour / 2 hours

### 10.1.2 STATIC PRESSURE UNIT DEFINITION

Enabling ventilation method used in the chicken/animal house:

- **Static pressure unit enabled:** After selecting any method, refer to Static Pressure, page 39 to define the static pressure parameters.
- **No unit enabled:** If you choose None, ventilation is controlled by time or a potentiometer. Refer to Vent & Curtain Levels, page 55.

## 10.2 Relay Layout

Use this screen to define the devices connected to the controller.

1. Select the requested choice from the menu list by using the up/down cursor keys (refer to Output Function List, page 140).
2. Repeat for each card.

*NOTE* If required, you can set the relay number manually.

3. If the required code is 100 and above, use the '+/-' keys before selecting and then press a two-digit number. For example 135 would be +/-35.
4. To duplicate relays use the 'As Relay # X' where 'X' stands for a relay number defined already in the system.

RELAY LAYOUT			
Relay	Function	Num	NO/NC
<b>CARD 1</b>			
1	< None >	0	—
2	< None >	0	—
3	< None >	0	—
4	< None >	0	—
5	< None >	0	—
6	< None >	0	—
7	< None >	0	—
8	< None >	0	—
9	< None >	0	—
10	< None >	0	—
N.O. Relay			

RELAY LAYOUT			
Relay	Function	Num	NO/NC
<b>CARD 1</b>			
1	Vent Open	1	—
2	Vent Open	2	—
3	Vent Close	1	—
4	Vent Close	2	—
5	Heat	1	—
6	Heat	2	—
7	Curtain Open	1	—
8	Curtain Close	1	—
9	< None >	0	—
10	< None >	0	—
N.O. Relay			

If you have installed Current Sense relays, the controller defines them automatically. Current sense relays transmit to the user's PC the amount of the current being passed to the relay and send alarms when the current is too low or too high. In addition, you can view the daily electricity consumption in History. Refer to Current Sense Relay Calibration, page 133 for calibration instructions.

## 10.2.1 OUTPUT FUNCTION LIST

	Relay Name	Quantity Supported
1.	Heaters	16
2.	Radiant Heaters Low	16
3.	Radiant Heaters High	16
4.	Radiant Heaters Ignite	16
5.	Tunnel Fan	30
6.	Exhaust Fan	20
7.	Stir Fan	15
8.	Cooling	4
9.	Cooling Pad	<ul style="list-style-type: none"> <li>• 4 (Version 6.20 and below)</li> <li>• 6 (Version 6.21)</li> </ul>
10.	Fogger	4
11.	Vent (Inlet) Open	<ul style="list-style-type: none"> <li>• 2 (Version 6.18 and below)</li> <li>• 4 (Version 6.19)</li> </ul>
12.	Vent (Inlet) Close	<ul style="list-style-type: none"> <li>• 2 (Version 6.18 and below)</li> <li>• 4 (Version 6.19)</li> </ul>
13.	Tunnel Open	<ul style="list-style-type: none"> <li>• 4 (Version 6.18 and below)</li> <li>• 6 (Version 6.19)</li> </ul>
14.	Tunnel Close	<ul style="list-style-type: none"> <li>• 4 (Version 6.18 and below)</li> <li>• 6 (Version 6.19)</li> </ul>
15.	Curtain Open	4
16.	Curtain Close	4
17.	Attic Open	1
18.	Attic Close	1
19.	Vent Speed	1
20.	Light	4
21.	Water	4
22.	Feeder	4
23.	Auger	4
24.	Extra System	4
25.	Alarm (N.C.)	1
26.	Fail Safe (N.C.)	1
27.	Feeder Win Open	1
28.	Feeder Win Close	1
29.	Feeder Line Up	1
30.	Feeder Line Down	1
31.	Drink Line Up	1

	Relay Name	Quantity Supported
32.	Drink Line Down	1
33.	Water Main	1
34.	Water Bypass	1
35.	Water Line	10
36.	WOD	4
37.	AS Relay	8
38.	AS Analog Output	8

### 10.2.2 RELAY LAYOUT – HELP | SET DEFINITIONS

② While viewing the Relay Layout menu: Press **HELP**, select **SET** and press **ENTER**.

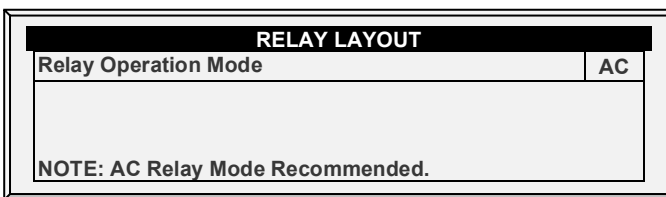

- Define relay operation mode: DC or AC.

*NOTE AC mode produces less heat in the controller box.*

### 10.3 Analog Sensors

➡ Install analog input cards.

This screen enables configuring the analog sensors. The controller regards temperature, humidity, CO2, light, and wind direction sensors as well as circuit breakers and potentiometers as analog sensors. These sensors measure a continuous range rather than just on or off.

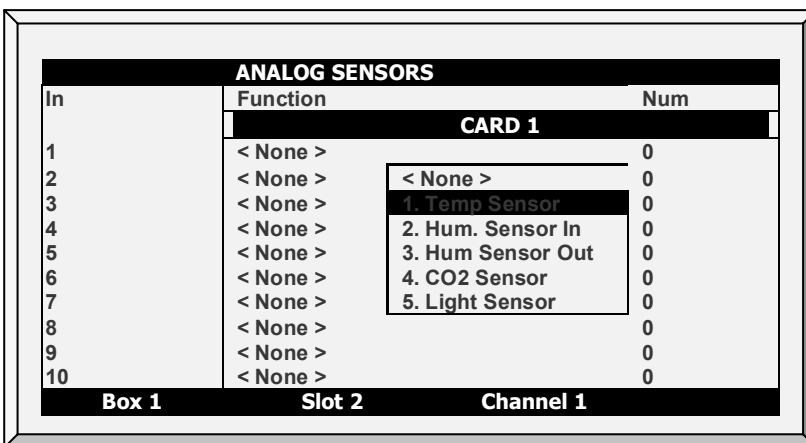

ANALOG SENSORS		
In	Function	Num
<b>CARD 1</b>		
1	Temp Sensor 1	1
2	Temp Sensor 2	2
3	Temp Sensor 3	3
4	Temp Sensor 4	4
5	Temp Sensor 5	5
6	Temp Sensor 6	6
7	Temp Sensor 7	7
8	Hum Sensor	1
	In1	
9	Light Sensor	1
10	Potentiometer	1
<b>Box 1</b>	<b>Slot 2</b>	<b>Channel 1</b>

1. Select the requested choice from the menu list by using the up/down cursor keys.
2. Repeat for each card.

*NOTE* If sensor numbers duplicate, the sensors average.

## 10.4 Digital Sensors

➔ Install digital input cards.

This screen enables configuring the installed digital sensors. These sensors monitor both water and feed consumption if the building is equipped accordingly. Digital inputs include on/off and pulsing inputs such as auxiliary alarms, pulsing water meters, cool pad/fogger water meter, wind speed sensors, and rain detectors.

DIGITAL SENSORS		
In	Function	
<b>CARD 1</b>		
1	< None	<None>
2	< None	1. Water Meter
3	< None	2. Cool Pad Water Meter
4	< None	3. Fogger Water Meter
5	< None	4. Feed Count
6	< None	
7	< None	
8	< None	
<b>Box 1</b>	<b>Slot 2</b>	<b>Channel 1</b>



DIGITAL SENSORS		
In	Function	No.
<b>CARD 1</b>		
1	Water Meter	1
2	Auger – 1 Overtime	1
3	Cool Pad Water Meter	1
4	Fogger Water Meter	1
5	Water Meter	2
6	RDT-5 Active	1
7	RDT-5 Active	2
8	< None >	0
<b>Box 1</b>	<b>Slot 2</b>	<b>Channel 1</b>

1. Enter sensor wired to each digital input card (setup according to technician).
2. Repeat for each card.

The controller automatically numbers the sensors according to their function.

*NOTE You cannot define more than the permitted number of any particular sensor. For example, you can define one function as Cool Pad Water Meter, not two.*

## 10.5 Analog Output

➤ Install analog output cards.

Analog output can be used to control:

- Variable speed fans
- Variable stir fans
- Vents
- Curtains
- Light dimmers
- Variable heaters
- Tunnels
- Floor heat (up to two; Pigs mode only)

Analog Output				
Out Num	Function	Num	Min V.Out	Max V. Out
<b>CARD 1</b>				
1	Light Dimmer	1	0.0	10.0
2	Light Dimmer	2	0.0	10.0
3	< None >	0	1. Variable Speed 2. Light Dimmer 3. Var. Stir Fan 4. Var. Heater 5. Vent	
4	< None >	0		
5	< None >	0		
6	< None >	0		
7	< None >	0		
8	< None >	0		
Box 1 Slot 3 Channel 1				



ANALOG OUTPUT				
Out Num	Function	Num	Min V.Out	Max V. Out
<b>CARD 1</b>				
1	Light Dimmer	1	0.0	10.0
2	Light Dimmer	2	0.0	10.0
3	Variable Speed	3	0.0	10.0
4	Curtain	2	1.0	9.0
5	Vent	2	1.0	9.0
6	Tunnel	1	1.0	9.0
7	Tunnel	2	1.0	9.0
8	Var. Heater	1	0.0	10.0
Box 1 Slot 3 Channel 1				

1. Enter sensor wired to each analog output card (setup according to technician).
2. Repeat for each card.

- The above is an example of an analog output configuration.

*NOTE Version 6.19 supports six tunnel curtains and four vents in Broiler and Breeder modes. Previous editions support four tunnel curtains and two vents.*

### 10.5.1 LIGHT DIMMER, VARIABLE SPEED FAN, VARIABLE HEATER, VARIABLE STIR FAN CONTROL

- To configure the light dimmers, refer to Light, page 66.
- To configure the variable speed fans, refer to Stir Fan Levels, page 56.
- To configure the variable heaters, refer to Temperature Curve Help | Set Definitions, page 20.
- To configure variable speed fans, refer to Stir Fan Levels, page 56.

### 10.5.2 VENT, TUNNEL, AND CURTAIN ANALOG OUTPUT CONTROL

Vents, tunnels, and curtains can be controlled via:

- A physical relay (device is physically wired to a relay) (refer to page 139) OR
- An analog output (device is wired to an actuator that is connected to the Controller analog output card)

Assigning an analog output to a vent, tunnel, or curtain enables them to open and close automatically, according to the analog output.

1. Define an output as vent, tunnel, or curtain.
2. Record the output number.
3. Enter the minimum and maximum voltage outputs according to the actuators' requirements.

However, to enable opening and closing manually, a relay must be mapped to the analog output.

**NOTE:** *The following steps are optional.*

4. Go to *Installation > Relay Output*.
5. Define a relay as *Analog Out (38)*.
6. Place the cursor in the number column and enter the recorded output number.
7. Repeat for each relay.

**NOTE** *If a vent is operating over analog output, there potentiometer feed-back support is disabled.*

## 10.6 Light Dimmers

The controller supports configuring up to five RLED 2.0 Light Dimmers from the Platinum Pro/Rotem Pro screen. RLED 2.0 can be connected via a communication card or via an analog output card. Each RLED 2.0 has two independent channels; meaning five RLED 2.0 units fulfill the role of ten light channels.

- Install the units before attempting to configure the RLED 2.0s. Light Dimmers only appear in the Installation Menu if RLED 2.0s are connected to the controller. Refer to the Installation Manual for details.

**NOTE** *In the following screens, if an RLED 2.0 is connected to an analog output card, ~ appears next to the light line (for example: ~Light 6).*

1. Go to *Test > Hardware Checklist* and verify that RLED appears and that the status is OK.



HARDWARE CHECKLIST				
Card	Box	Slot	Status	Chann.
Alarm 1				1
<b>Relays</b>				<b>40</b>
N.O. 1	1	1	OK	10
N.O. 2	1	2	OK	10
N.O. 3	1	3	OK	10
N.O. 4	1	4	OK	10
<b>RDT5 RLED</b>				<b>0</b>
RLED 1	4	2	OK	2
RLED 2	4	3	OK	2
RLED 3	4	4	OK	2
RLED 4	4	5	OK	2
RLED 5	4	6	OK	2

- If the status is not OK, recheck the wiring.
- If an RLED 2.0 is connected to an analog output card
  - The RLED 2.0 appears under Analog Output.
  - The channel address is 0.

2. Go to *Installation > Light Dimmers*.

3. On each line and channel (for example ADD-1, CH-A), map a lighting line to an RLED 2.0 channel. In this example, there are five RLED 2.0s, controlling all 10 lighting lines.

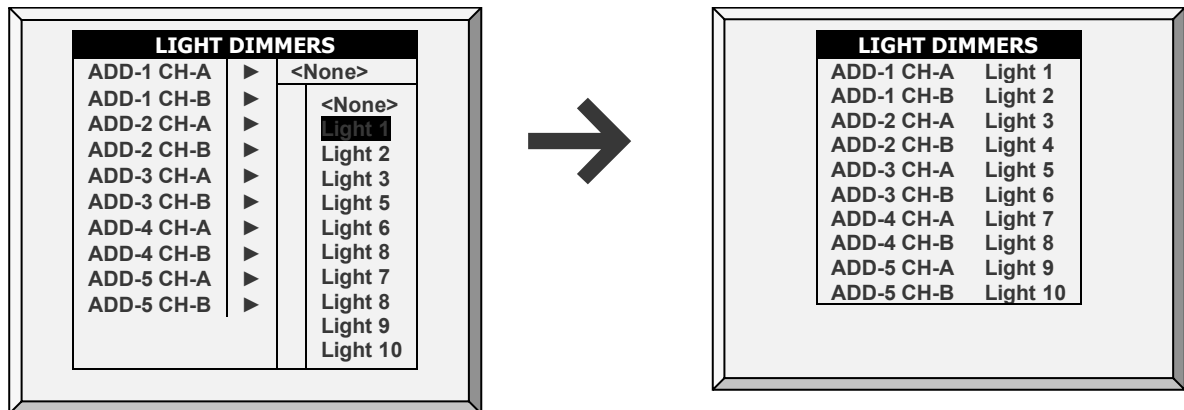

- You can map the channels to the light lines in any order.

4. Go to *Device > Light*.

LIGHT																	
Day	Time	Light								Intensity (%)							
		1	2	3	4	5	6	7	8	1	2	3					
1	00:00	✓	✓	■	■	■	■	■	■	100	50	50	50	50	50	50	100
12	00:00	✓	✓	■	■	■	■	■	■	45	45	0	0	0	0	0	0
12	01:00	■	■	■	■	■	■	■	✓	0	0	0	0	0	0	0	0
12	03:00	✓	✓	■	■	■	■	■	✓	45	45	0	0	0	0	0	0
12	21:00	■	■	■	■	■	■	■	✓	0	0	0	0	0	0	0	0
25	00:00	■	■	■	■	■	■	■	✓	0	0	0	0	0	0	0	0
25	03:00	■	■	■	■	■	■	■	✓	35	35	0	0	0	0	0	0
25	20:00	■	■	■	■	■	■	■	✓	0	0	0	0	0	0	0	0
25	23:00	■	■	■	■	■	■	■	✓	35	35	0	0	0	0	0	0
0	00:00									0	0	0	0	0	0	0	0

5. Define the parameters as described in Light, page 66.

6. The main screen now displays the active and inactive light lines.

SENSORS		AV. TEMP.	ACTIVE	
Temp1	37.9°	27.5°	<input checked="" type="checkbox"/>	Light 1 100%
Temp2	16.2°	<b>STATUS</b>	<input checked="" type="checkbox"/>	Light 2 50%
Temp3	28.2°		<input type="checkbox"/>	Light 3 50%
E. Tmp1	28.8°	08:53:06	<input type="checkbox"/>	Light 4 50%
E. Tmp2	28.4°	Day: 2	<input type="checkbox"/>	Light 5 50%
Press.	23	Set: 25.0	<input type="checkbox"/>	Light 5 50%
Out T.	23.9°	Level: 3	<input type="checkbox"/>	Light 6 50%
Hum. In	58.7%	Min. Vent	<input type="checkbox"/>	Light 7 50%
Hum. Out	61.9%	FanOff: 176	<input type="checkbox"/>	Light 8 100%
Weight	0.000			
Weights	0			
<b>4 MESSAGES</b>				
(2) Low Feed At Bin 2				

## 10.7 Vent / Curtain Setup

➤ In Installation > Setup, define Static Pressure unit as None.

Use this screen to define the ventilation opening and closing mechanism. You can use one of three methods:

- Time
- Potentiometer
- Wind Direction (Natural programming only)

If you map a curtain or vent to a potentiometer, the controller uses that method (and not time).

- After defining the method used, define the opening levels in Vent & Curtain Levels, page 55.
- In addition, the controller enables turning off the fans if the curtain is not in the proper position. Refer to Stop Fans, page 148.
- Refer to Curtains Calibration, page 136 to configure calibration accuracy parameters.

### 10.7.1 USING TIME CONTROL

- Enter the number of seconds to open and close from limit to limit for each of the Vents and Curtains in your installation.

The controller calculates the percentage of open and closed time and adjusts the static pressure methods accordingly.

VENT / CURTAIN SETUP				
Curtain	Pot	Open (sec)	Close (sec)	Wind Dir
Curtain 1	NONE	60	60	45
Curtain 2	NONE	60	60	45
Inlet 1	NONE	60	60	0
Inlet 2	NONE	60	60	0
Tunnel	NONE	60	60	0
1st Vent	NONE	60	60	0
2st Vent	NONE	60	60	0
Attic Vent	NONE	60	60	0

- Set full open/full close time (in seconds) for Curtains, Tunnel, 1<sup>st</sup> & 2<sup>nd</sup> Vent, and Attic Vent.

**NOTE:** *Default is set at 60 seconds.*

## 10.7.2 USING POTENTIOMETER CONTROL

Each curtain/vent/inlet can be mapped to a potentiometer. Potentiometer feedback enables precise positioning on each specific device opening value. In this screen, assign a potentiometer to a device.

VENT / CURTAIN SETUP				
Curtain	Pot	Open (sec)	Close (sec)	Wind Dir
Curtain 1	POT 1	60	60	45
Curtain 2	POT 2	60	60	45
Inlet 1	POT3	60	60	0
Inlet 2	NONE	60	60	0
Tunnel	NONE	60	60	0
1st Vent	NONE	60	60	0
2st Vent	NONE	60	60	0
Attic Vent	NONE	60	60	0

1. Map the analog sensors as potentiometers as required (Analog Sensors, page 141)
2. Map the curtain/vent/tunnel/inlet to a potentiometer in this screen.
3. Calibrate the potentiometer (Ventilation Potentiometer Calibration, page 126).

**NOTE:** *After calibrating the potentiometer, the times shown here change to reflect the calibration process.*

In the event that the potentiometer fails (meaning there is no value change during the curtains/vents/inlets movement):

- Alarm message is transmitted.
- The specific curtain/vent/inlet mapped to the failed potentiometer starts operating by time calculation, using the times calculated by the calibration process. However, if required you can enter new opening and closing times.
- **Version 6.19:** If a curtain or vent (controlled by a potentiometer) should open or close but does not move the controller sends an alarm.
  - The controller sends an alarm if the curtain/vent moves less than 1% of the required movement within 30 seconds (this number cannot be changed).
  - Controllers only send alarms when the Potentiometer Alarm is enabled (page 96).
  - No alarm is sent if the curtain/vent is:
    - Within 95 - 100% and opening
    - With 5 - 0 % and closing

### 10.7.3 USING WIND DIRECTION

This parameter is used only when Natural Ventilation is enabled. Refer to Preliminary Steps, page 77 for details.

### 10.7.4 STOP FANS

Stop Fan parameter enables turning off fans if a specific curtain is moving below its minimum position. This function prevents the curtain from sticking if the static pressure is too high and curtains have not yet moved into a position which will cause the pressure to drop.

VENT / CURTAIN SETUP						
~	Curtain	Pot	Open (sec)	Close (sec)	Wind Dir	Stop Fan
	Curtain 1	NONE	60	60	45	NO
	Curtain 2	NONE	60	60	45	NO
	Inlet 1	NONE	60	60	0	NO
	Inlet 2	NONE	60	60	0	NO
	Tunnel	NONE	60	60	0	NO
	Vent 1	NONE	60	60	0	NO
	Vent 2	NONE	60	60	0	NO
	Attic Vent	NONE	60	60	0	NO

*NOTE Default is NO.*

*NOTE The ~ symbol designates an analog output device.*

### 10.8 Temperature Definition

This screen assigns specific temperature sensors for various brood setups and for heater zones. Moreover, assigning sensors to particular devices is possible. Note that if the sensors selection remains blank, the default value is assigned.

Choose 1 to 18 temperature sensors for each item listed by using the '+/-' keys. The house, brooding and tunnel sensors cause the current average to apply to devices when no specific sensor is assigned to them. The current average substitutes for either failed or missing sensors.

*NOTE Sensors 10 – 18 require installing a second analog card.*

TEMPERATURE DEFINITION	
Function	Temp. Sensor 1 2 3 4 5 6 7 8 9
Full House	√√√ . . . . .
Tunnel setting	. . . . .
Attic	. . . √ . . .
Outside	. . . . √ . .
Stir Fan 1	. . . . √ . .
~ Stir Fan 2	. . . . √ . .
~ Var. Heat 1	. . . . √ . .
Cooling Pad 1	. . . . √ . .
Cooling Pad 2	. . √ . . . .

1. In *Install > Relay Outlet*, define the relays as required.
2. In *Install > Temp Definition*, map the sensors and press Enter.

3. Press +/- key to add/remove ✓ to assign temperature sensors to corresponding function.

- Refer to Temperature Curve, page 19.
- Assign Temperature Sensors as required in *Install > Temp Definition*. Devices that do not accept temperature sensors, such as Exhaust Fans, Tunnel Fans, Feed and Light do not appear.

*NOTE If you are using two (2) input analog input cards, the screen displays Temp. Sensor(s) 1-18 (refer to above screen capture).*

*NOTE When an attic sensor is not installed, the attic vent is disabled.*

*NOTE The ~ symbol designates an analog output device.*

Note that Exhaust Fans and Tunnel Fans do not appear because the Ventilation Levels defined in *Device > Levels of Ventilation* control their operation. Stir Fans appear even though the *Device > Stir Fan Levels* apply to them because they simultaneously operate according to *Device > Stir Fan Programs* where specific sensor assignments are required in Program B and recommended in Program C.

## 10.9 Fan Air Capacity

This screen enables defining the fans' air capacity. Insert fan air capacity for both the exhaust and tunnel fans.

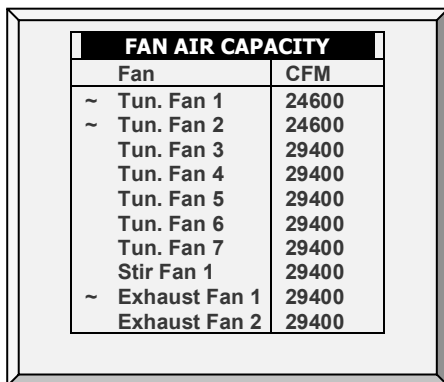

FAN AIR CAPACITY	
Fan	CFM
~ Tun. Fan 1	24600
~ Tun. Fan 2	24600
Tun. Fan 3	29400
Tun. Fan 4	29400
Tun. Fan 5	29400
Tun. Fan 6	29400
Tun. Fan 7	29400
Stir Fan 1	29400
~ Exhaust Fan 1	29400
Exhaust Fan 2	29400

1. In *Install > Relay Outlet*, and/or *Installation > Analog Output* define the ventilation relays.
2. In *Installation > Setup*, define the fan air capacity unit.
3. In *Install > Fan Air Capacity*, define the air capacity and press Enter.

*NOTE This data enables displaying air capacity for each level in the Levels of Ventilation table.*

## 10.10 House Dimensions

The screen allows the user to set its' house dimensions. Set it according to the actual house size. These dimensions are used for calculating the wind chill factor (the chilling effect of the wind that can significantly lower the temperature).

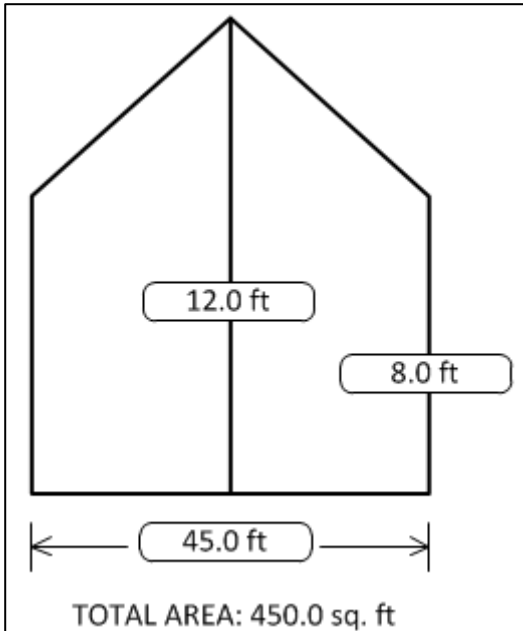

- Define height, width, and length of house (controller calculates total area).
- To set the dimensions in metric or non-metric units, go to *Installation > Setup* and scroll down to Length Unit.

**NOTE** This information enables the calculation of the Wind Chill factor displayed in Hot Screen Key = 2 (Tunnel mode ONLY).

## 10.11 Communication

This screen defines the communication parameters.

COMMUNICATION SETUP	
Baud Rate	9600
House Number	1

- Define the communication setup:
    - **Baud rate:** This parameter is a measure of the communication speed for local or remote communications to a PC. The default is 9600 represents a data rate of approximately 1000 characters per second. If the connection fails at this speed, try a lower speed.
- CAUTION** The baud rate used must be the same in all controllers, computers, and other devices.
- **House number:** Each controller on a network must have a unique number (1 – 64))

# 11 Appendix A: Output Data

Table 1: Sensor Readings

Sensor	Definition
Temp	Displayed with the specific sensor number
Out T.	Outside temperature
Press.	Pressure
Hum. In	Inside humidity
Hum. Out	Outside humidity
Weight	Average weight
Weights	Number of weights
Breaker	Circuit breaker

Table 2: Output List (Active)

Output	Definition
Alarm	Can be either active or not. Note that this always appears last.
Heat	Indicates operating heat number
Heat. Hi	Indicates operating heat high number
Tun. Fan	Indicates operating tunnel fan number
Exh. Fan	Indicates operating exhaust fan number
Stir	Indicates operating stir fan number
Cool P.	Indicates operating cool pad number
Fogger	Indicates operating fogger number
Inlet	
Tunnel	
Curt.	Mentions opening percentage
Ext. Sys	Indicates operating external system number
Light	Note that these mention output percentage
Water	Indicates operating water number
Feed	Indicates operating feed number
Auger	Indicates operating auger number
Rad. Lo	Indicates operating radiant heat low number
Rad. Hi	Indicates operating radiant heat high number

Table 3: Status Readings

Status	Definition
Time	Specific time
Day	Growth day
Set	Target temperature
Offset	Temperature Curve HELP   SET parameter
House mode	Control Mode HELP  SET parameter
Level	Level number
Tunnel, Natural, Min. Vent	The controller's state
Fan Off	How long the cycle ends its' operation
Fan On	How long the cycle begins its' operation
Curve off	Occurs when located in low curve temperature or when the Control Mode HELP   SET 'Temperature Curve' parameter is set to OFF.
Hum. Treat	Indicates when treatment occurs
Cool flush	Indicates when flush occurs
Nip. Flush	Indicates when flush occurs

Table 4: Table of Events

Event	Event Explanation
Power Off	Appears when power is off
Power On	Appears when power is on
Cold Start	Appears when cold start is done
Change level to vent	Changes according to a specific stage
Backup set reminder	HELP   SET: 'Set Temp. Change remainder (diff)' parameter
Alarm on	Appears when the alarm is on
Change in setting	
Change in switches	Relay switch setting changed
New flock	Appears when new flock is updated
Reset alarm	Appears when reset alarm is done
System message #	For Munters technicians only
Alarm card fail	Appears when the alarm card fails
Digital card fail	Appears when the digital card fails
Memory restore	Appears when the system does restore cause by noises
Minimum ventilation	Appears when minimum ventilation occurs
Natural ventilation	Appears when entering natural ventilation
Tunnel ventilation	Appears when entering tunnel ventilation
Alarm test	Appears when alarm test completes
Precision Mode	Switch to Precision Mode
Standard Mode	Switch to Standard Mode
Changed growth day	Appears when changing the growth day occurs



Event	Event Explanation
MinV L.P Alarm Dis.	Appears when minimum low-pressure alarm is disabled
MinV L.P Alarm Ena	Appears when minimum low-pressure alarm is enabled
Tun. L.P Alarm Dis.	Appears when tunnel low pressure alarm is disabled
Tun L.P Alarm Ena.	Appears when tunnel low pressure alarm is enabled
Visitor Log in	Appears when the visitor logs in with his password
User #1-5 log in	Appears when the user logs in with his password
Owner log in	Appears when the owner logs in with his password
Change Visitor pass	Appears when the visitor changed his password.
Change User #1-5 pass	Appears when the user changed his password
Change Owner pass	Appears when the owner changed his password
Data read from plug	Appears when data is read from plug
System recover	Appears when the system tries to recover itself, in cases such as noises
System lock	Appears when either using the correct password, or when using hot key '9,' or automatically after 5 minutes
Empty house mode	Appears when setting at a specific time
<b>Version 6.23</b>	
Ref Weight Change	Appears when Curve Offset is manually changed in Scale>Bird Weight>Settings. Change can be a different curve, gender, or offset.
Factor Change	Appears when Factor is manually changed in Scale>Calibration
Scale or Silo Calibration	Appears when silos/scales are manually calibrated in Scale>Calibration

# 12 Appendix B: Layers Mode

This section details functions specific to the Layers mode.

- Layers Main Screen
- Layers Vent and Curtain Levels
- Egg Counter

## 12.1 Layers Main Screen

SENSORS		AV. TEMP.	ACTIVE	
Temp1	37.9°	27.5°	Heat	1
Temp2	16.2°		Heat. Hi	1
Eggs 1	0		Tun. Fan	
E. Tmp1	28.8°		Exh. Fan	
E. Tmp2	28.4°		Stir	
Press.	23		Cool P.	
Out T.	23.9°		Fogger	
Hum. In	58.7%		Inlet 1	55%
Hum. Out	61.9%		Inlet 2	55%
Weight	0.000		Inlet 3	50%
Weights	0		Tun. 1	0%
			Alarm	0%
<b>4 MESSAGES</b>				
(2) Low Feed At Silo 2				

Figure 23: Layers Main Screen

ACTIVE	
Heat	1
Heat. Hi	1
Tun. Fan	
Exh. Fan	
Stir	
Cool P.	
Fogger	
Inlet 1	55%
Inlet 2	55%
Inlet 3	50%
Tun 1	0%
Attic	0%

Figure 24: Layers Mode Active Sensors

## 12.2 Layers Vent and Curtain Levels

DEVICE SETTING	
1. LEVELS OF VENTILATION	
2. SPEED FAN LEVELS	
<b>3. VENT &amp; CURTAIN LEVELS</b>	
4. STIR FAN LEVELS	
5. STIR FAN PROGRAM	
6. COOL PAD	
7. FOGGERS	
8. LIGHT	
9. WATER & FEED	
10. EXTRA SYSTEMS	
11. WATER ON DEMAND	
12. NATURAL PROGRAM	

Set the curtain levels to correspond with the ventilation levels.

1. In *Install* > *Relay Outlet* (page 139), define at least one relay as a Curtain Open, Tunnel Open, Vent Open, or Inlet Open.
2. In *Install* > *Setup*, enable Natural Ventilation (page 138).
3. In *Device Setting* > *Vent & Curtain Levels*, define the fans' working percentages.
4. Set the Help Set parameters as required.

VENT & CURTAIN LEVELS		
Level	Attic	Tunnel
1	45	45
2	45	45
3	40	40
4	40	40
5	45	45
6	45	45
7	45	45
8	45	45
9	45	45
10	40	40

- **Ventilation Level:** Read-only.
- **Tunnel/Curtain/Vent:** Set position for the tunnel curtain by level. If you have Static Pressure in Tunnel turned on (Control | Static Pressure | Help | Set), this becomes the minimum position for the tunnel inlet.

*NOTE* Refer to *Vent & Curtain Levels Help | Set Definitions for Help Set details*.

### 12.2.1 LAYER INLET CONTROL

Inlets can be controlled via two methods:

- **Pressure:** In this mode, inlets open and close according to the static pressure.
- **Position:** In this mode, inlets open and close according to the temperature.

To select the inlet control method:

1. Go to *Device* > *Vent & Curtain Levels* > *Help*.
2. Scroll down to Zone Inlet and select Press or Pos.

### 12.2.1.1 Pressure Control

When set to Pressure control, the inlets work similarly to vents; namely, the inlets open and close according to the static pressure. Each inlet is independent; no inlet controls another inlet. The number shown is the opening percentage.

VENT & CURTAIN LEVELS	
Level	Inlet Avg
1	45
2	45
3	40
4	40
5	45
6	45
7	45
8	45
9	45
10	40

- Level: Read-only
- Inlet Average: Opening percentage

**NOTE:** *The remaining Help > Set parameters are not relevant when using Pressure control.*

To set pressure control:

1. At each level, place the cursor and type the inlet average level.
2. Press Enter.
3. Go to *Install > Curtain Setup* (page 144) and set the opening and closing times.

### 12.2.1.2 Position Control

When set to Position control, the inlets open and close according to the temperature. As the actual temperature differs from the target temperature, the inlet opens or closes. The number shown is the opening percentage.

VENT & CURTAIN LEVELS				
Level	Inlet Avg	Inlet 1	Inlet 2	Inlet 3
1	50	45	40	45
2	40	35	30	35
3	0	0	0	0
4	0	0	0	0
5	0	0	0	0
6	0	0	0	0
7	0	0	0	0
8	0	0	0	0
9	0	0	0	0
10	0	0	0	0

- Level: Read-only.
- Inlet Average: Set the opening position for all inlets by level.
- Inlet 1/2/3 – 12: Set the opening level for an individual inlet by level. Set up to 12 inlets.

**NOTE:** When setting individual inlet openings, configure each inlet to work with a particular temperature sensor. Refer to page 148.

To set position control:

1. At each level, place the cursor and type the opening level.
2. Press Enter.
  - Whichever parameter, the Inlet Avg or Inlet 1/2/3, is set last determines the opening level. For example, if you enter parameters for Inlet 1/2/3, and then enter the Inlet Avg parameter, this number overrides the Inlet 1/2/3 parameters.
  - Entering "0" disables the parameter.

### 12.2.2 LAYER VENT & CURTAIN (INLET) LEVELS HELP | SET DEFINITIONS

SYSTEM PARAMETERS	
<b>ATTIC</b>	
Minimum Attic Temp. To Operate	85
Operate Until Day	10
Operate Until Level	10
Operate From Time	0:00
Operate To Time	0:00
Max Temperature to Disable Attic	100.0
<b>ZONE INLET</b>	
Operation by Pressure/Position	POS.
Compensation % Per Degree	3
Delay for Compensation (min)	5
Maximum Compensation Opening	10
Temp. Compensation Hysteresis	0.5
Absolute Minimum Position (%)	5
Motor Delay (seconds)	0

#### Zone Inlet

- **Operation by Pressure/Position:** Sets the inlet opening mode, by Pressure or Position. Default: Position.

**NOTE** Configure the Compensation Percentage, Delay, Maximum Compensation and Temperature Compensation only when using Operation by Position.

- **Compensation % Per Degree:** For each degree that the actual temperature differs from the Target Temperature, the inlets:
  - open by this percentage (if the actual temperature is above the target temperature)
  - close by this percentage (if the actual temperature is below the target temperature)

For example, if the actual temperature is 2° above the target temperature, the inlet opens an additional 6%. Default: 1 %/°F
- **Delay for Compensation (minutes):** As the temperature sensors record changes in temperature, the controller waits for this amount of time before changing the inlet position. Default: 5 minutes
- **Maximum Compensation Opening:** Inlet opening does not differentiate from the set level more than this amount, regardless of the temperature. Default: 10%
- **Temperature Compensation Hysteresis:** Temperature band defining when compensation begins. Default: ±0.5° F

For example, if the Target Temperature is 80° and the Temperature Compensation Hysteresis is 1°, compensation begins above 81° or below 79°.

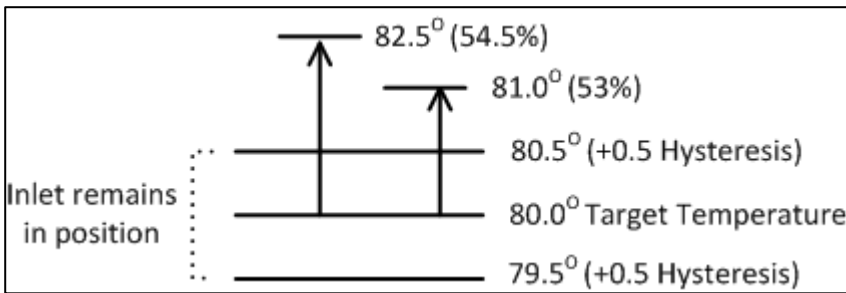

Figure 25: Example of Inlet Opening Hysteresis

Figure 25 illustrates an example of inlet hysteresis. An inlet is set to open to 50%, with a compensation of 3% for each degree. The target temperature is 80.0°, with a hysteresis of 0.5°. Between 79.5° to 80.5°, the inlet remains at 50%. If the temperature rises to 81.0°, the opening goes to 53%.

- **Absolute Minimum Position (%):** Defines the minimum open position for the zone inlets. They will not close below this parameter.
- **Motor Delay (seconds):** Time delay before motors that open or close zone inlets begin to operate.

### 12.3 Egg Counter

Refer to Egg Counter, page 161.

# 13 Appendix C: Breeder Mode

- Egg Room Setup
- Egg Counter
- Egg Room Water and Feed
- Egg Belt Runtime
- Egg Room Hot Screen
- Nest Function
- Work Room Control
- Scale Arm
- Weighing the Birds in Breeder
- Breeder Advanced Feeding
- Egg Room History

SENSORS		AV. TEMP.	ACTIVE	
Temp1	37.9°	27.5°	Heat	1
Temp2	16.2°	<b>STATUS</b>	Heat. Hi	1
Temp3	28.2°		Tun. Fan	
F.Wgt	3.21	08:53:06	Exh. Fan	
M. Wgt	3.33	Day: 2	Stir	
Press.	23	Set: 25.0	Cool P.	
Out T.	23.9°	Level: 3	Fogger	
Hum. In	58.7%	Min. Vent	Curt. 1	100%
Hum. Out	61.9%	FanOff: 176	Curt. 2	100%
<b>4 MESSAGES</b>			Feeder	
(2) Low Feed At Bin 2			Auger	
			Valve	
			Alarm	

## 13.1 Egg Room Setup

CONTROL
1. TEMPERATURE CURVE
2. HUMIDITY TREATMENT
3. CO2 TREATMENT
4. MIN/MAX LEVEL
5. STATIC PRESSURE
6. CONTROL MODE
7. SYSTEM PARAMETERS
8. EGG ROOM
9. WORK ROOM
10. AMMONIA TREATMENT

The following procedures detail the steps required to set up the Egg Room functions.

1. In *Install > Relay Layout*, define five relays as:
  - Egg room heater
  - Egg room fan 1

- Egg room fan 2
- Egg Room Cool
- Humidifier

RELAY LAYOUT			
Relay	Function	Num	NO/NC
1	Hum. Egg Room Sensor	1	—
2	Egg Room Cooling	1	—
3	Egg Room Heater	1	—
4	Egg Room Fan	2	—
5	< None>	1	—
6	< None>	2	—
7	< None>	1	—
8	< None>	1	—
10	< None>	9	< None>
N.O. Relay			

NOTE Refer to Relay Layout, page 139 for details on this screen.

2. In *Install > Analog Sensors*, set the input functions as Temperature Sensors and as an Egg Room Humidity sensor.

NOTE Refer to Analog Sensors, page 141 for details on this screen.

3. In *Install > Temperature Definition*, configure which temperature sensors operate in the egg room.

TEMPERATURE DEFINITION	
Function	Temp. Sensor
	1 2 3 4 5 6 7 8 9
Full House	√√ . . . . .
Tunnel setting	. . . . .
Attic	. . . √ . . .
Outside	. . . . √ . .
Egg Room	. . . . √ . .
Work Room	. . . . √ . .
Feed Area	. . . . .

NOTE Refer to Temperature Definition, page 148 for details on this screen.

NOTE After defining egg room temperature sensors, the egg room temperature appears on the main screen.

SENSORS	
Temp1	37.9°
Temp2	16.2°
Temp3	28.2°
E. Tmp1	28.8°
E. Tmp2	28.4°
Egg Room	28.4

4. In *Service > Humidity Calibration*, calibrate the Egg Room humidity sensor.



HUMIDITY CALIBRATION		
Sensor	Humidity°	Factor
In-1	58.9	2.3
In-2	58.9	2.3
Out	N/A	---
Egg Room	67	2.0

Press Left/Right Arrows to Calibrate

NOTE Refer to Humidity Calibration, page 122 for details on this screen.

5. In Control > Egg Room, set the following on/off parameters:

- Heater temperature
- Fan 1 temperature
- Fan 2 temperature
- Cooling temperature
- Humidifier relative humidity percentage

EGG ROOM CONTROL		
Function	On	Off
Heater Temp	62.0	66.0
Fan 1 Temp	70.0	66.0
Fan 2 Temp	70.0	66.0
Cooling Temp	74.0	70.0
Humidifier %rh	65	70

6. In Control > Egg Room > Help > Set, configure the following alarm parameters:

- Low Temperature
- High Temperature
- Low Humidity
- High Humidity
- Delay (minutes)

EGG ROOM	
ALARM	
Low Temp	62.6
High Temp	71.6
Low Humidity	70
High Humidity	80
Delay (minute)	60

The Breeder Mode is configured.

## 13.2 Egg Counter

Breeders Mode supports up to four egg counters per house. The controller supports Accucount infra-red egg counters (refer to the Egg Counter manual for details). The following sections detail the setup.

1. In *Install > Digital Sensors*, define up to four Egg Counters.

DIGITAL SENSORS		
In	Function	Num
1	Water Meter	1
2	Auger – 1 Overtime	1
3	Cool Pad Water Meter	1
4	Egg Counter	1
5	Egg Counter	2
6	Egg Counter	3
7	Egg Counter	4
8	< None >	0

2. Set the Alarms (refer to Alarm Setting Help | Set Definitions, page 94 for details on how to set alarms).

- **Low Feed Alarm Limit:** Alarm if feed in Silo 1-8 is below this limit and time is between From and To limits.

### Egg Counter Alarm

- **Alarm Active From/Until:** Set the period for which the controller generates alarms.
- **Low Egg House Count Eggs/Minute:** Define the number of eggs per minute at which an alarm is generated.
- **Low Count Alarm Delay (min):** Set the minimum period of time low egg count must extend through before generating an alarm.

3. The Main Screen displays the current day's total egg count.

SENSORS		AV. TEMP.	ACTIVE
Eggs 1	500	27.5°	
Eggs 2	50		
Eggs 3	300		
Eggs 4	400		
		<b>STATUS</b>	
		08:53:06	
		Day: 2	
		Set: 25.0	
		Level: 3	
		Min. Vent	
		FanOff: 176	
<b>4 MESSAGES</b>			
Low Egg Count House 2			

4. To test the egg counter sensor(s), go to *Test > Digital Sensors*.

DIGITAL IN TEST			
In.	Sensor	State	Counter
1	Egg Counter 1	1	0
2	Egg Counter 2	0	0
3	Egg Counter 3	0	0
4	Egg Counter 4	0	0
5	<None>	0	0
6	<None>	0	0
7	<None>	0	0
8	<None>	0	0

5. To view the cumulative egg count, go to *History > Eggs*.

EGGS				
Day.	1	2	3	4
1	524	457	567	345
2	567	455	587	350
3	0	0	0	0
4	0	0	0	0
5	0	0	0	0
6	0	0	0	0
7	0	0	0	0
8	0	0	0	0

### 13.3 Egg Room Water and Feed

In Breeder Mode, the water and feed schedule is independent of the growth day. In addition, Breeder Mode enables lowering the target temperature during the feeding time. When birds begin to feed, they congregate near the feeders and the temperature rises (which negatively affects the birds' feed intake). To compensate, increase the ventilation before/during the feeding time by lowering the target.

- Water and Feed Version 6.23 and Below
- Water and Feed Version 6.24 and Above

#### 13.3.1 WATER AND FEED VERSION 6.23 AND BELOW

1. Go to *Device > Water & Feed*.

WATER & FEED							
Time		Water		Feeder		Auger	
From	To	1	2	1	2	1	2
4:00	4:30	●	■	●	■	●	■
4:45	5:15	●	■	●	■	●	■
5:00	5:30	●	◐	■	◐	●	◐
7:00	8:00						
0:00	0:00						
0:00	0:00						
0:00	0:00						
0:00	0:00						
0:00	0:00						

**NOTE** When using *Breeding Advanced Feeding*, *Auger* does not appear.

2. Set the parameters as required:
  - **Time:** Set event times for water, feeder, or auger.
  - Set the water, feeder, and auger lines to Continuous, Cycle, or Off.
3. In *Install > Setup*, define *Feed Area* as *Yes*.

**NOTE** If you do not define *Feed Area* as *Yes*, *Feed Area* does not appear in *Temperature Definition*.

4. In *Install > Temperature Definition*, map a temperature sensor(s) to the feed area (optional).

TEMPERATURE DEFINITION	
Function	Temp. Sensor 1 2 3 4 5 6 7 8 9
Full House	√√√ . . . . .
Tunnel setting	. . . . .
Attic	. . . . .
Outside	. . . . .
Egg Room	. . . . .
Work Room	. . . . .
Feed Area	. . . . .

5. Go to Device > Water & Feed > Help.

WATER & FEED	
<b>TEMP TARGET ADJUST</b>	
Change Target From:	4:45
Change Target To:	8:00
Temp Target Offset:	-5.0
<b>FEED LINE OPERATION</b>	
Line 1 Down (hh:mm)	4:45
Line 1 Up (hh:mm)	5:00
Line 2 Down (hh:mm)	4:45
Line 2 Up (hh:mm)	5:00
<b>WATER CYCLE TIME</b>	
Cycle On	30
Cycle Off	270
<b>FEEDER CYCLE TIME</b>	
Cycle On	60
Cycle Off	200
<b>AUGER CYCLE TIME</b>	
Cycle On	50
Cycle Off	50

*NOTE* When using Breeding Advanced Feeding, Auger Cycle Time does not appear. Refer to page 169.

6. If a device is set to Cycle, define the Water/Feeder/Auger On and Off times.
7. To adjust the target temperature during feeding (to increase ventilation):
  - a. Define the To/From times.
  - b. Define the Target Temperature Offset (to reduce the target).

*NOTE* To disable this feature set the offset to 0.

8. To control the male breeders feeding time:
  - a. Under Feed Line Operation, define when the lines descend and rise (Line Down, Line Up times).
  - b. Go to Service > Feed Line Calibration.
  - c. Enter the amount of time required for the curtains to rise and descend.

*NOTE* Measure these times if you don't know them.

FEED LINE CALIBRATION	
Function	Run Time (sec).
Feed Line 1 Up	60
Feed Line 1 Down	50
Feed Line 2 Up	80
Feed Line 2 Down	40

**Additional points:**

- In Breeder Mode, the controller supports up to:
  - 10 feeders
  - Four water lines
  - Four augers

Define these functions in Install > Relays.

- To and From times can overlap. For example, in the table above one line goes from 4:45 to 5:15 and the next line goes from 5:00 to 5:30. If there is overlap and contradictory configurations, the priority is Continuous > Cycle > Off. In the example above:
  - Water Line 2 will run in a cycle from 5:00 until 5:30.
  - Feeder Line 1 will be on from 4:45 until 5:15, even though line 3 turns off the feeder.

**13.3.2 WATER AND FEED VERSION 6.24 AND ABOVE**

When running Platinum in Breeder Basic Mode, Version 6.24 and above Water, Feeder, and Auger Tables appear in separate windows; each window can be configured independently. The functionality and configuration are the same as in Version 6.23.

WATER			
Time		Water	
From	To	1	2
4:00	4:30	●	■
4:45	5:15	●	■
5:00	5:30	●	●
7:00	8:00		
0:00	0:00		
0:00	0:00		
0:00	0:00		
0:00	0:00		
0:00	0:00		
0:00	0:00		
0:00	0:00		

FEEDER			
Time		FEEDER	
From	To	1	2
4:00	4:30	●	■
4:45	5:15	●	■
5:00	5:30	●	●
7:00	8:00		
0:00	0:00		
0:00	0:00		
0:00	0:00		
0:00	0:00		
0:00	0:00		
0:00	0:00		
0:00	0:00		

AUGER			
Time		Auger	
From	To	1	2
4:00	4:30	●	■
4:45	5:15	●	■
5:00	5:30	●	●
7:00	8:00		
0:00	0:00		
0:00	0:00		
0:00	0:00		
0:00	0:00		
0:00	0:00		
0:00	0:00		
0:00	0:00		

**13.4 Egg Belt Runtime**

Breeder Mode supports measuring the egg belt runtime.

➡ Install digital input cards.

1. Go to *Install > Digital Sensors*.

DIGITAL SENSORS		
In	Function	Num
1	Water Meter	1
2	Auger – 1 Overtime	1
3	Cool Pad Water Meter	1
4	Fogger Water Meter	1
5	Water Meter	2
6	Feeder Over Time	1
7	<b>Egg Belt</b>	1
8	< None >	0

2. Define a sensor as Egg Belt.

3. Go to History > Egg Belt Run Time to view the data.

## 13.5 Breeder Hot Keys

The Breeder Mode supports the following additional Hot Screens:



Egg Room Status. This screen displays the current temperature, relative humidity, and readings from the five relays.



Bird Scale: Bird Scale Hot Screen displays weight according to gender (if scales are defined as both male and female).



Advanced Feeding: This screen feed data for males and females.

## 13.6 Nest Function

User employing Version 6.18 or below, refer to Breeder Nest Function, Version 6.18 and Below, page 190.

The Nest function enables opening and closing (up to) four Nest lines at specific times. Birds can then leave their Nests and return. In Version 6.19, the nest function operates in two different manners, depending on the number of relays required to open and close the nests.

- Single Relay
- Dual Relay

### 13.6.1 SINGLE RELAY

When using a single relay:

- applying electricity opens the cages.
- ceasing the electricity closes the cages.

The user defines when the relay opens (allows current) and when the relay closes (ceases current), thereby opening or closing the cage.

1. In Installation > Relay Layout designate up to four relays as Nest Open relays. The number of defined relays is what appears in the screen.

*NOTE In this setup there is no need to designate relays as Nest Close.*

2. In Device > Nest > Set Definitions, define the Nest Mode as Single (default is Dual).

SYSTEM PARAMETERS	
NEST	
Nest Mode	Single
Dual Mode	
Open Duration Time (sec)	30
Close Duration Time (sec)	30

3. In Device > Nest, define the:

- Time: This schedules when the relay enables or disables current to flow (daily).
- Nest: Under each nest, define if it opens or closes.
  - ∙: Cage closes
  - √: Cage opens

In the example below, Nests 3 and 4 open at 12:00 and close at 15:00. Nests 1 and 2 open at 15:00 and remain open until 12:00 the following day.

Nests		
Num	Time hh:mm	Nest 1 2 3 4
1	12:00	∙ ∙ √ √
2	15:00	√ √ ∙ ∙
3	0:00	∙ ∙ ∙ ∙
4	0:00	∙ ∙ ∙ ∙

### 13.6.2 DUAL RELAY

When using dual relays, one relay opens the cage and the second closes the cage. A specific command must be given for each function. Cages remain open or closed until a command is given to change the status.

1. In Installation > Relay Layout designate up to four relays (each) as Nest Open and Nest Close relays. The number of defined relays is what appears in the screen.
2. In Device > Nest > Set Definitions, define the Nest Mode as Dual (default is Dual).

SYSTEM PARAMETERS	
NEST	
Nest Mode	Dual
<b>Dual Mode</b>	
Open Duration Time (sec)	30
Close Duration Time (sec)	30

3. Define the time required to open or close the cage.
4. In Device > Nest, define the:
  - Time: This schedules a relay is activated.
  - Nest: Under each nest, define which relay operates on a nest.
    - O: Nest opens
    - C: Nest closes
    - ∙: No action (relay is closed or released)

In the example below, Nests 3 and 4 open at 12:00. Nest 2 opens at 15:00. Nest 3 closes at 16:00, while Nests 2 and 4 remain open.

Nests		
Num	Time hh:mm	Nest 1 2 3 4
1	12:00	∙ ∙ O O
2	15:00	∙ O ∙ ∙
3	16:00	∙ ∙ C ∙
4	0:00	∙ ∙ ∙ ∙

## 13.7 Work Room Control

This screen enables controlling the temperature in the work room.

WORK ROOM CONTROL		
Function	On	Off
Heater 1 (Temp)	16.7	18.9
Heater 2 (Temp)	16.7	18.9
Fan 1 (Temp)	21.1	18.9
Fan 2 (Temp)	21.1	18.9

1. In *Control > Work Room*, set the following on/off parameters:

- Heater 1 and 2 temperatures
- Fan 1 temperature
- Fan 2 temperature

2. In *Install > Temperature Definition*, define 1 or 2 sensors as Work Room temperature sensors (refer to Temperature Definition, page 110 for details on this function)

TEMPERATURE DEFINITION		Temp. Sensor								
Function		1	2	3	4	5	6	7	8	9
Full House		√	√	√	•	•	•	•	•	•
Tunnel setting		•	•	•	•	•	•	•	•	•
Attic		•	•	•	√	•	•	•	•	•
Outside		•	•	•	•	•	√	•	•	•
Egg Room		•	•	•	•	•	•	√	•	•
Work Room		•	•	•	•	•	•	•	√	•
Feed Area		•	•	•	•	•	•	•	•	√

## 13.8 Scale Arm

During feed distribution, each silo has a mechanical arm that disconnects at the end of a feed cycle, preventing further distribution. When this disconnect happens, a signal is sent from the arm to the silo, informing the latter that it must be refilled. The controller enables recording these signals in the Events History.

To define the Scale Arm:

1. Go to *Install > Digital Sensors*.
2. Define one sensor as Scale Arm.

DIGITAL SENSORS		
In	Function	Num
1	Scale Arm	1
2	< None >	0
3	< None >	0
4	< None >	1
5	< None >	0
6	< None >	0
7	< None >	0
8	< None >	0

- In *History > Table of Events*, Feed Delivered appears when the mechanical arm disconnects.



TABLE OF EVENTS			
	Event	Day	Time
1	Feed Delivered	1	13:27:05

### 13.9 Weighing the Birds in Breeder

The following section details how to set up scales to weigh the birds. In Versions 6.22 or above, setting up a bird curve means defining the following items in the Scale Menu:

- [Scale Card](#): Define at least one scale.
- [Bird Scale Setting](#): Define the curve type (Auto, Custom, or Factory Curve)
- [Bird Weight](#): Define the reference weight or curve data points (day and weight).

*NOTE Users employing a previous software version, refer to Appendix D: Previous Version Functions, page 181.*

1. Go to Scale > Scale Layout. Use Scale Layout to define the scales or silos connected to the controller.

*NOTE A scale card must be installed in the controller or an RSU-2 unit must be connected to the controller for these screens to appear.*

Platinum Pro/Rotem One supports the RSU-2 and two types of scale cards:

- Two channel scale cards: Supports bird scales only.
- Six channel scale cards: Supports bird and silo. The controller can support up to ten weighing channels.
- Refer to the installation manual regarding Munters' recommendations regarding these options.

SCALE LAYOUT		
Scale Card		
Chan.	Function	No.
1	Silo 1	1
2	Silo 2	2
RSU 1		
1	Silo 3	3
2	Silo 4	4

SCALE LAYOUT		
Ch.	Function	No.
Scale Card		
1	Scale	1
2	Scale	2
3	Silo	1
4	Silo	2
5	Feed Scales	1
6	Scale	3
RSU 1		
1	Silo 3	3
2	Scale 3	3

<None>  
 1. Scale  
 2. Silo  
 3. Feed Scales

Figure 26: Two Channel Layout

Figure 27: Six Channel Layout

2. Go to Scale Menu> Bird Scale > Help. Select Auto or Manual.

BIRD SCALE SETTING	
Range Method	Auto Manual

This parameter defines which measured bird weights are used in calculating the actual curve. Bird weights that are outside of the band are discarded.

- If you select Auto, Platinum calculates the band of acceptable weights.
- If you select Manual, define the female/male upper and lower weight ranges.

BIRD SCALE SETTING	
Range Method	Manual
<b>Female</b>	
Upper Range [%]	10
Lower Range [%]	15
<b>Male</b>	
Upper Range [%]	15
Lower Range [%]	10

3. Go to Scale Settings > Bird Scale Settings.

BIRD SCALE SETTING	
Weighing Method	Auto
Scale 1	Female
Scale 2	Female
Scale 3	Female
Scale 4	Female

Auto  
 Curve  
 Auto Turkey

- Define the weighing method: Auto, Curve, Auto Turkey. Curve includes a user-defined curve option and industrial standard curve options.
- Define each scale as female or male.
  - Version 6.24:
    - Define each scale as male, female, or male and female.
    - Define the time period during which weight data is collected.

BIRD SCALE SETTING	
Weighing Method	Auto
Scale 1	Female
Scale 2	Male
Scale 3	Male&Female
Scale 4	Female
From Time	12:00
To Time	15:00

- Auto or Auto Turkey Curve
- Customized/Industrial Standard Curves

### 13.9.1 AUTO OR AUTO TURKEY CURVE

- Go to Scale > Bird Weight.
  - If you selected Auto or Auto Turkey in Bird Scale, edit the weights as required; weights are automatically updated.

BIRD WEIGHT	
Current Female Weight	0.09
Current Male Weight	0.09

- If you selected Curve in Bird Scale, the male and female curves are displayed.

BIRD WEIGHT		
Day	Female	Male
0	0.00	0.00
7	0.00	0.00
14	0.00	0.00
21	0.00	0.00
28	0.00	0.00

### 13.9.2 CUSTOMIZED/INDUSTRIAL STANDARD CURVES

1. Go to Scale > Bird Weight > Help.

SYSTEM PARAMETERS	
<b>Female</b>	
Curve Offset	0.00
Select Curve	Custom
<b>Male</b>	
Curve Offset	0.00
Select Curve	CobbMV

2. For female and male, enter the factor used to adjust the weight curve. This amount is added to the Reference weight field. Range: 0.0 – 10.0 Kg/Lb.

3. For female and male, select the required curve from the drop-down list.

4. Go to Scale > Bird Weight.

BIRD WEIGHT		
Day	Female	Male
0	0.09	0.09
7	0.35	0.33
14	0.62	0.75
21	0.88	1.16
28	1.15	1.53

- If you selected Custom, you can edit the curve.
- If you selected an industrial standard curve, the curve is read only.

### 13.9.3 BIRD WEIGHT HISTORY

The scale history shows bird weight statistics for female and male houses. You can review daily data for each gender or for each scale.

HISTORY							
Day	Female.	Uniformity	No.	Male	Unif.	No.	
1	0.00	0.00	0.00	0.00	0.00	0.00	
2	0.00	0.00	0.00	0.00	0.00	0.00	
3	0.00	0.00	0.00	0.00	0.00	0.00	

### 13.10 Breeder Advanced Feeding

Breeder Mode supports a unique feed mixing and distribution system that includes:

- Mixing feed from up to eight silos
- Distributing the feed to up to eight different feed lines
- Differentiating between male, female, or mixed gender flocks

- Support for up to 24 feeding stations (16 female and 8 males)
- Support up to eight overtime digital inputs

In this system (up to eight) silos place their feed onto auger lines, which transport the feed to a feed scale container. The feed is mixed in the feed scale container and then placed into hoppers, from which the feed is transported to the birds. What is unique in this program is the flexibility in designing feeding lines for male, female, and mixed lines. Using the controller program, you define the entire feeding program:

- mapping silos to augers
- how much feed from each silo
- what type of feeding program to use
- which feeding stations are active

How does it work?

- Silos deliver feed to the feed scale container; the user defines how much feed each silo delivers (in percentages of the total weight).
- After delivering the feed, the silo augers are turned off and feed is placed in the hopper from which the feed is then placed into feed lines.
- Each hopper delivers feed to one or two lines:
  - If one feed line is used it can supply to feed to males, females, or both.
  - If two feed lines are used, one line is designated for the males and one line is designated for females.
- When the hopper empties, the process repeats itself until the supplied feed equals the defined target.
- Continuous feeding: In standard feeding, the feed line hoppers are filled serially. A line hopper valve does not open until the previous valve closes. In the advanced feeding mode, you can configure the setup to ensure that the delays between the feed line hopper fillings overlap.

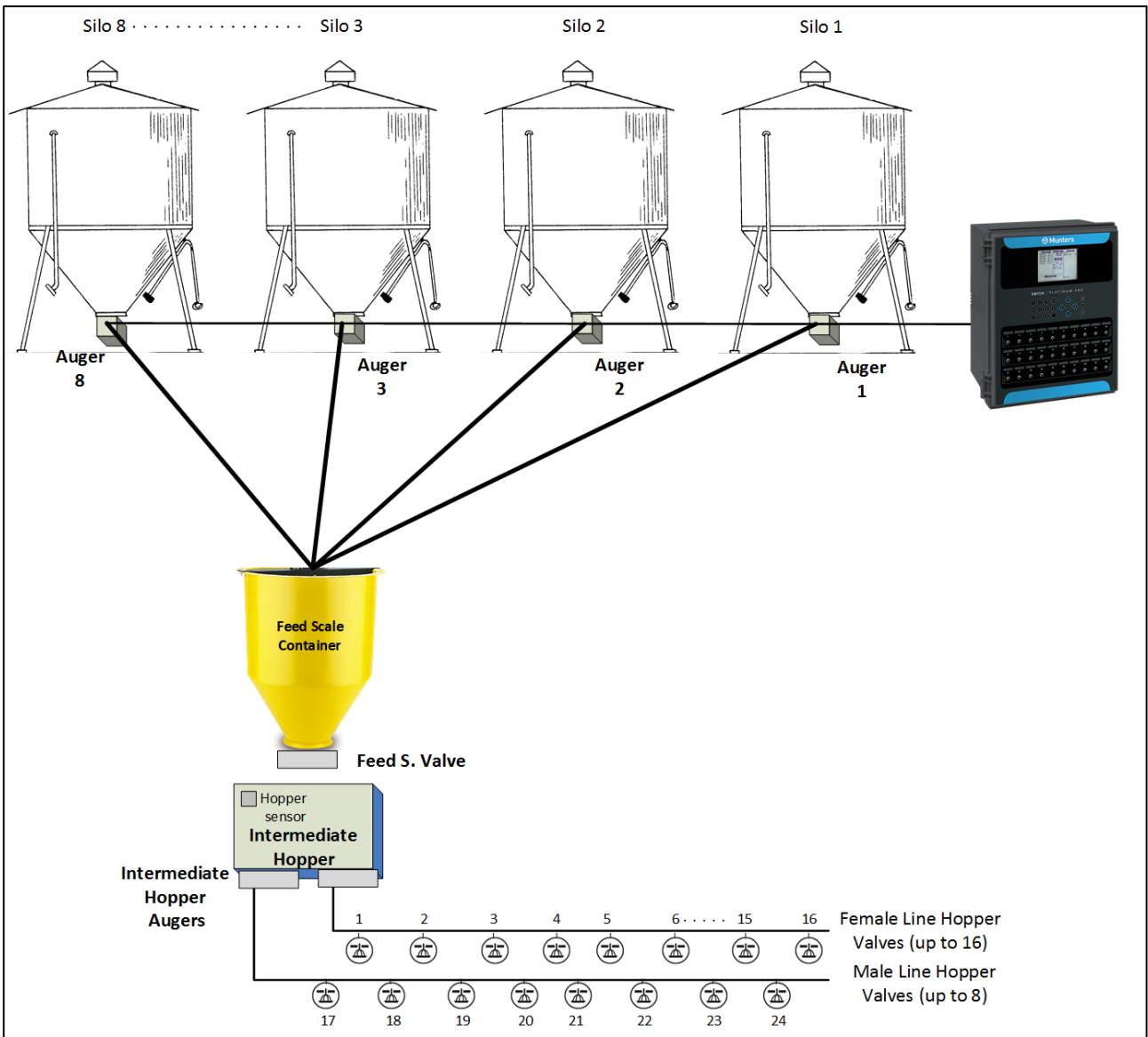

Figure 28: Dual Line Block diagram

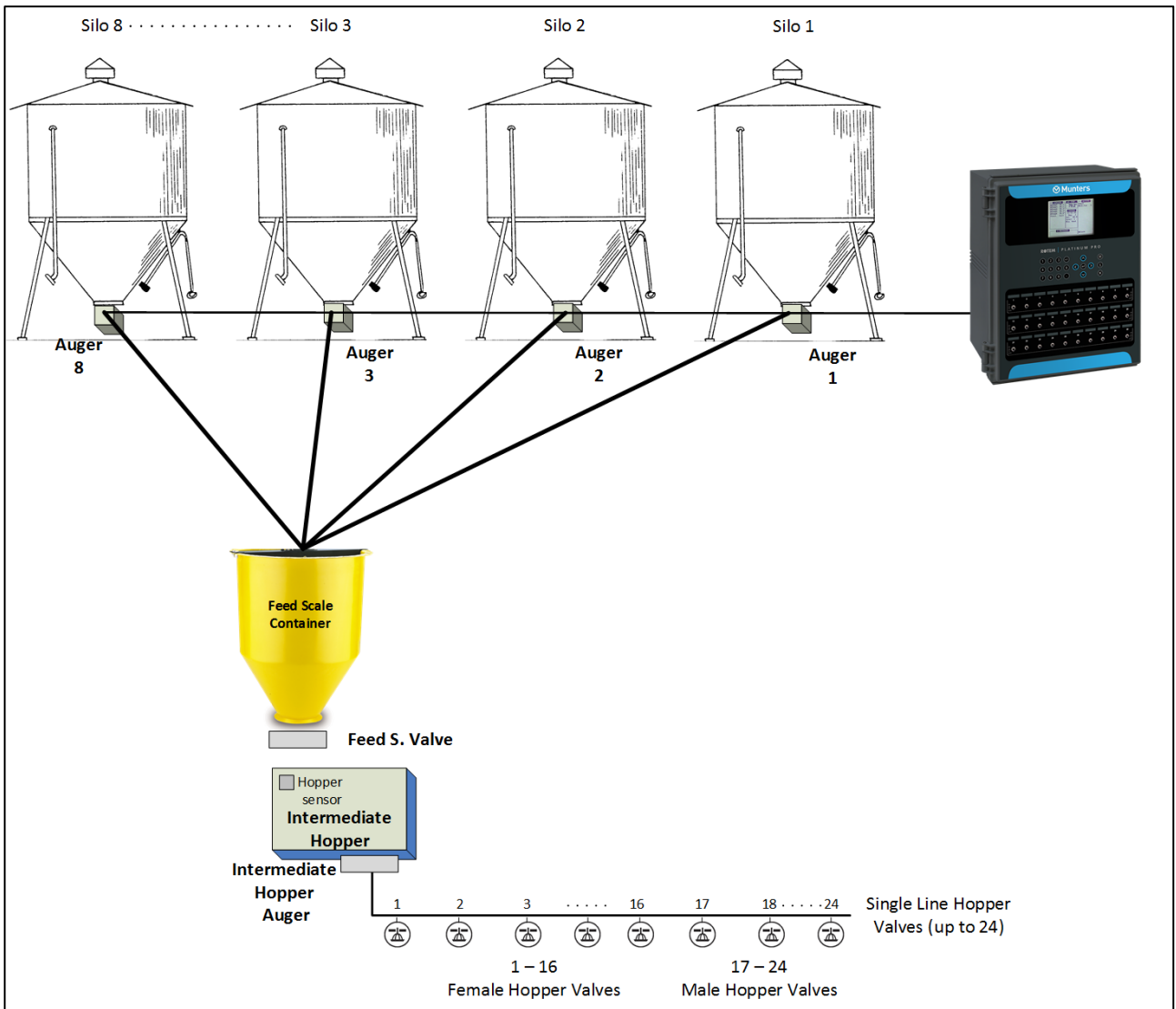

Figure 29: Single Line Block diagram

### 13.10.1 SELECTING THE ADVANCED FEEDING MODE

To enable the Breeder advanced feeding mode:

1. Disconnect the power cable from the power source.
2. Reapply power while pressing Delete. The Cold Start screen appears.
3. Select Yes. The Choose Controller Type appears.
4. Select the Breeder.
5. Select Precision.
6. Select Advanced Feeding.
7. Press Enter.

## 13.10.2 ADVANCED FEEDING SETUP

**WARNING!** Do not configure these screens while a feeding cycle is in progress.

1. Go to Installation > Relays.

RELAY LAYOUT			
Relay	Function	NO.	NC
<b>CARD 1</b>			
1	Auger	1	—
2	Auger	2	—
3	Auger	3	—
4	Auger	4	—
5	Auger	8	—
6	Auger	5	—
7	Auger	6	—
8	Feed Scale Valve	7	—
9	Line Hopper Valve	1	—
10	Inter. Hopper Auger	2	—
N.O. Relay			

2. Define:

- Up to eight relays as augers. These are the main silo augers.
  - As an option, you can manually number the augers.
- One feed scale valve (Version 6.22)
- Up to two intermediate hopper augers (male, female)
- Up to 24-line hopper valves.
  - Platinum Pro/Rotem Pro defines line hopper valves 1 – 16 as being female line hopper valves and valves 17 – 24 as being male line hopper valves.

*NOTE In Version 6.20, Platinum Pro/Rotem Pro support 16 male line hoppers (17 – 32).*

- If you are not using all 16 female valves or all 8 male valves, you can manually number the valves. For example, four valves can be numbered as 1 – 4 and the fifth valve numbered as 17.
- Number the female and male valves sequentially. For example:
  - 1 – 4 or 5 – 7 and 17 – 20 or 21 – 24 is fine.
  - 1, 4, 7, 9 and 17, 21, 24 is incorrect.

3. Go to Installation > Digital Sensors and define up to eight auger overtime sensors.

DIGITAL SENSORS		
In	Function	No.
<b>CARD 1</b>		
1	Augur Overtime	1
2	Augur Overtime	2
3	Augur Overtime	3
4	Augur Overtime	4
5	Augur Overtime	5
6	Augur Overtime	6
7	Augur Overtime	7
8	Augur Overtime	8
<b>Box 1</b>	<b>Slot 2</b>	<b>Channel 1</b>

4. Go to Device > Water & Feed.

WATER & FEED					
Time		Water		Feeder	
From	To	1	2	1	2
4:00	4:30	☐	☐	☐	☐
4:45	5:15	☐	☐	☐	☐
5:00	5:30	☐	☐	☐	☐
7:00	8:00				
0:00	0:00				
0:00	0:00				
0:00	0:00				
0:00	0:00				
0:00	0:00				
0:00	0:00				

5. Set the parameters as required:

- Time: Set event times for water or feeder.
- Set the water or feeder lines to Continuous, Cycle, or Off.

6. Go to Device > Water & Feed > Help.

WATER & FEED	
<b>TEMP TARGET ADJUST</b>	
Change Target From:	4:45
Change Target To:	8:00
Temp Target Offset:	-5.0
<b>FEED LINE OPERATION</b>	
Line 1 Down (hh:mm)	4:45
Line 1 Up (hh:mm)	5:00
Line 2 Down (hh:mm)	4:45
Line 2 Up (hh:mm)	5:00
<b>WATER CYCLE TIME</b>	
Cycle On	30
Cycle Off	270
<b>FEEDER CYCLE TIME</b>	
Cycle On	60
Cycle Off	200
<b>FEED CYCLE</b>	
Feed Day Cycle	DAILY

7. If a device is set to Cycle, define the Water/Feeder On and Off times.

8. To adjust the target temperature during feeding (to increase ventilation):

- Define the To/From times.
- Define the Target Temperature Offset (to reduce the target).

**NOTE** To disable this feature set the offset to 0.

- Feed Cycle: Set to:
  - Daily: Same schedule for every day of the week.
  - 2 – 6 Days: Select a cycle that lasts the number of days chosen and then repeats itself. For example, 2 Days means that the cycle lasts two days and then repeats itself.
  - Week: Set a cycle for specific days.

**NOTE** When the cycle is set to 2-6 days or Week, you can skip specific days by pressing the +/- key.

9. Go to Scale > Silo/Auger Layout.



SILO/AUGER LAYOUT		
Silo	Auger	Feed Type
1	Auger 1	Female
2	Auger 2	Male
3	Auger 3	Female
4	Auger 4	Female
5	Auger 5	Male
6	Auger 6	Male
7	Auger 7	Male
8	Auger 8	None

10. Map each silo to the silo auger number.

- To use this function, augers must be defined in Installation > Relay Layout. No mapping is possible unless augers have been defined.
- By default, the screen displays four silos and augers. If you define more than four relays as augers (or if you number even one auger relay as number 5 or higher), the screen displays eight silos.
- Even if all eight silos appear on the screen, the number of silos you can map equals the number of auger relays defined.
- Define the parameters:
  - Silo: Read only number.
  - Auger: This defines which auger is mapped to which silo. Define this as None (disabling the auger line) or Auger. The controller numbers the auger but you can manually edit the number. To edit, press the required number and then Enter.
  - Feed Type: If the silo contains feed designated for males or females, define that feed type in this parameter. None is the default setting.

11. In Management > Feed Inventory, enter the quantity of feed in each silo. Note that if the silos are equipped with load cells, this table is filled automatically.

FEED INVENTORY					
No.	Date	Silo			
		1	2	3	4
1	2-Jan-08	7800	0	0	0
2	5-Jan-08	0	9000	15000	10000
3	13-Jan-08	8000	0	0	0
4	- -	0	0	0	0
5	- -	0	0	0	0
6	- -	0	0	0	0
7	- -	0	0	0	0
8	- -	0	0	0	0
Total Feed:		15800	9000	150000	10000
ACTIVE		√	√	√	√

12. Go to Device > Feed Scale Program.

Note: This screen is wide and requires scrolling to view all parameters.

MIXING AND FILLING									
No	Start	Type	Silo			Inter Hopper Auger	Valves		
	Time		1	2	3		F 1	F 2	F 3
			M	F	M		5000.0	5000.0	1000.0
1	5:00	None	0	0	0	1	0	0	0
2	10:00	Female	50	50	0	1	50	50	50
3	7:00	Male	50	0	50	2	0	0	0
4	12:00	Male	34	33	33	1	50	50	50
5	0:00	Female	0	0	0	2	0	0	0
6	0:00	None	0	0	0	1	0	0	0

**NOTE** This screen's appearance depends on the relay layout and silo/auger layout and on the program version:

- Version 6.23: All silos appear in the Feed Scale Program screen.
- Version 6.24: Only those silos actually mapped to an auger appear in the Feed Scale Program screen.

### 13. Define the feed mixture and distribution parameters.

- Number: You can define up to 20 feeding times per day.
- Type: Designate this feeding time as one of the following:
  - Female or Male. When defined as Female or Male, only those augers whose feed type matches this definition will add feed to the mixture. For example, if Number 1 is defined as Male, any auger defined as Female will not add feed at this time. However, an auger defined as Both will add feed. (Augers are defined in Scale > Silo/Auger Layout> Feed Type)
  - None: This option disables a feeding time, while saving the feeding time's definitions. **When defined as None, you cannot edit that line's parameters.**
  - Erase: This option erases any parameter definitions for that number.
- Silo Augers (%): Under each auger, enter the percentage of feed that each silo provides. The default auger automatically adjusts its percentage as you define each auger's percentage.
  - In a line designated as Male or Female, you can only change the percentages of those augers matching the definition (or an auger defined as Both).
    - For example: If the line is defined as male, only augers defined as Male or Both can add feed. The cursor will automatically skip over any auger not matching the line definition.
    - Augers defined as None do not add feed.
- Inter. Hopper Auger: This parameter is read-only. If one auger is defined is defined, 1 appears. If two augers are defined, either one or two can appear.
  - If there is one auger line, this line can feed males or females (up to 24 valves).
    - Valves 1 – 16 are female,
    - Valves 17 – 24 are male (see Figure 29)
  - If there are two auger lines:
    - The Intermediate Hopper Auger 1 is mapped to the female line hoppers.
    - The Intermediate Hopper Auger 2 is mapped to the male line hoppers.

- Valves: Define the amount of feed that each feeding station receives.
  - Version 6.21: Range 0 – 22025 Lbs./0 –9999 Kg
  - Version 6.22: Range 0 – 22025.8 Lbs./0 –9999.9 Kg

14. If required, set the help options.

### 13.10.3 FEED SCALE PROGRAM HELP | SET DEFINITIONS

SYSTEM PARAMETERS	
<b>ADVANCED FEEDING SETTINGS</b>	
Maximum Portion Size	55
Maximum Auger Time (min)	10
Not Empty Time	60
Stop Band Weight	2.2
Optimizer	Default
Valve Close Time (sec)	7
Feed Tare (A/D count)	0
<b>Female Line of Hoppers</b>	
Auger Feed Rate (weight/min)	66
Time to 1st Hopper	120
Time to Last Hopper	240
Line Hopper Feed Gap	30

- Define:

#### ADVANCED FEEDING SETTINGS

- **Maximum Portion Weight:** Enter the feed scale container size.
- **Maximum Auger Time [minutes]:** This parameter sets an alarm for the auger running time. Enter the number of minutes that the auger can run, after which an alarm appears on the Main Screen.
- **Not Empty Time:** This parameter (in minutes) sets an alarm for the feed scale container. The container should distribute all of its feed to the feed lines. If feed remains in the container, it could mean that there is a problem (for example, the valve doesn't open). Set the amount of time that feed can remain in the container, after which an alarm appears on the Main Screen.
- **Stop Band Weight:** This parameter (kilos or pounds) defines the band at which augers cease to distribute feed. When the amount of feed distributed approaches the maximum portion weight by this amount, the controller ceases the distribution.
- **Optimizer:** This parameter sets the unit's sensitivity to signal noise (caused by a variety of factors). The sensitivity plays a role as the controller stabilizes itself. Greater amounts of noise require faster optimization. To view an indication of the controller's stability, go to *Scale Menu > Test* (refer to page 110) and perform a test. If the number remains stable, slower optimization is indicated. There are three settings: Default, Slower, Faster.

*NOTE Munters recommends leaving this parameter at the default level.*

- **Valve Close Time [seconds]:** Set the delay in time, if any, that the valve emptying the feed scale container closes.
- **Feed Tare [A/D count]:** This specification is used for certain tests performed by a certified technician.

*NOTE Munters recommends leaving this parameter unedited.*

## Female/Male Line of Hoppers

- Auger Feed Rate (weight/min): Define the amount of feed to be sent to the birds over a defined amount of time.

**NOTE** If you define one relay only as the Inter. Hopper Auger, enter the same rate in both the Female and Male Line of Hoppers.

- Time to 1st Hopper: Amount of time required for feed to travel from the intermediate hopper to the first hopper valve.
- Time to Last Hopper: Amount of time required for feed to travel from the intermediate hopper to the last hopper valve. Note that the last valve is the last valve actually defined. For example if six valves are defined, enter the amount of time required for the feed to reach valve number six.
- Line Hopper Feed Gap: The amount of time required for feed to travel the distance between each hopper.

### 13.11 Egg Room History

- Go to *History > Egg Room* to view a daily history of the egg room temperature and humidity. Press the right/left arrow keys to switch between views.

EGG ROOM			
Day	TEMPERATURE		
	Minimum	Average	Maximum
1	76	79	80

EGG ROOM			
Day	HUMIDITY		
	Minimum	Average	Maximum
1	62	65	69

# 14 Appendix D: Previous Version Functions

This chapter provides information for people employing versions 6.21 and below.

- Scale Menu, Version 6.21 and Below
- Test, Version 6.17 and Below
- Vent & Curtain Levels Help | Set Definitions Version 6.18 or Below
- Breeder Nest Function, Version 6.18 and Below

## 14.1 Scale Menu, Version 6.21 and Below

- Setting up a Curve – Summary
- Scale Layout
- Bird Scale Setting
- Gender Based Weighing, Version 6.21
- Bird Curve/Bird Weight
- History

### 14.1.1 SETTING UP A CURVE – SUMMARY

*NOTE A Scale Card or RSU must be installed.*

setting up a bird curve means defining the following items in the Scale Menu:

- [Scale Card](#): Define at least one scale.
- [Bird Scale](#): Define the curve type (Auto, Custom, or Cobb/Robb)
- [Bird Weight](#): Define the curve data points (day and weight; Custom or Cobb/Robb curves only).

In Versions 6.21 or above there is an additional option [enabling gender-based weighing for birds](#).

### 14.1.2 SCALE LAYOUT

Use Scale Layout to define the scales or silos connected to the controller.

*NOTE A scale card must be installed in the controller or an RSU-2 unit must be connected to the controller for these screens to appear.*

Version 6.18 supports the RSU-2 and two types of scale cards:

- Two channel scale cards: Supports bird scales only.
- Six channel scale cards: Supports bird, silo, and feed scales (Breeder Mode does not support feed scales). The controller can support up to ten weighing channels.

- Refer to the installation manual regarding Munters' recommendations regarding these options.

SCALE LAYOUT		
Scale Card		
Chan.	Function	No.
1	Silo 1	1
2	Silo 2	2
RSU 1		
1	Silo 3	3
2	Silo 4	4

Figure 30: Two Channel Layout

SCALE LAYOUT		
Ch.	Function	No.
Scale Card		
1	Scale	1
2	Scale	2
3	Silo	1
4	Silo	2
5	Feed Scales	1
6	Scale	3
RSU 1		
1	Silo 3	3
2	Scale 3	3

<None>  
1. Scale  
2. Silo  
3. Feed Scales

Figure 31: Six Channel Layout

### 14.1.3 BIRD SCALE SETTING

- Define at least one scale, silo, or feed scale in Scale Layout.

*NOTE* This section describes the Bird Scale Settings for Broiler mode. Refer to Breeder and Layer Mode appendices to view the function for those modes.

#### 14.1.3.1 Bird Scale Setting Screen

In this screen, select the algorithm used to calculate the bird curve that appears in Bird Weight, Version 6.19. There are three options:

BIRD SCALE SETTING	
Weighing Method	Auto

- Auto
- Custom
- Cobb 500
- Cobb 700
- Ross 308
- Ross 708

- **Auto:** Set the first target weight. The controller then automatically calculates each day's reference weight.
- **Custom:** The controller provides a weight vs growth day curve, which the user can edit as required.
- **Factory Default Curve:** The controller loads an industry standard bird curve. This curve cannot be edited.

#### 14.1.3.2 Bird Scale Setting | Set Definitions

- ② While viewing the Bird Scale Setting menu: Press **HELP**, select **SET**, and press **ENTER**.

BIRD SCALE SETTING	
Upper Range [%]	25
Lower Range [%]	25

- The upper/lower range parameters define the range of weights that are recorded. The weights of birds that exceed differ from the bird curve by these amounts are discarded.

#### 14.1.4 GENDER BASED WEIGHING, VERSION 6.21

*NOTE Version 6.21 and above supports this version.*

- Enabling Gender Based Weighing
- Measuring Gender-Defined Bird Weights, Auto Curve
- Measuring Gender-Defined Bird Weights, Customized/Industrial Standard Curve

##### 14.1.4.1 Enabling Gender Based Weighing

Gender Based Weighing enables setting up separate reference weight curves for male and female birds.

To enable gender-based bird curves:

1. Go to Scale > Scale Layout > Help.

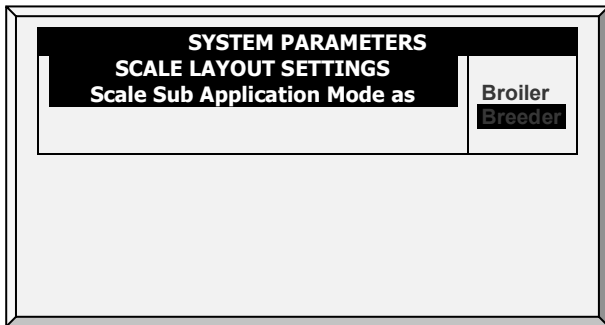

2. Select Breeder.
  - Breeder includes two options for setting up the curve: a controller-generated curve and an industrial standard curve.
    - Measuring Gender-Defined Bird Weights, Auto Curve
    - Measuring Gender-Defined Bird Weights, Customized/Industrial Standard Curve

The Broiler option enables a single weight curve. Continue defining the curve as detailed in Bird Weight, Version 6.19.

##### 14.1.4.2 Measuring Gender-Defined Bird Weights, Auto Curve

1. Go to Scale > Bird Scale Setting.

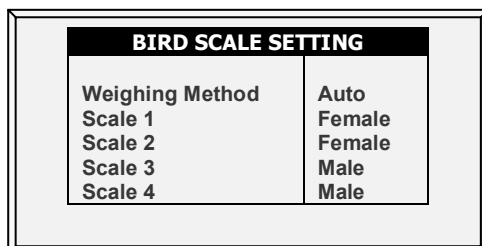

2. In Weighing Method, select Auto.
3. Go to Scale > Bird Scale Setting > Help. Define the parameters (option).

BIRD SCALE SETTING	
<b>Female</b>	
Upper Range [%]	10
Lower Range [%]	15
<b>Male</b>	
Upper Range [%]	15
Lower Range [%]	10

- Male/Female: The upper/lower range parameters defines the range of weights that are recorded. The weights of birds that exceed differ from the bird curve by these amounts are discarded. Note that the default range of the female and male bird are reversed.

4. Go to Scale > Bird Weight.

BIRD WEIGHT	
Current Female Weight	0.09
Current Male Weight	0.09

5. The Bird Weight screen displays the target weight for the current growth day for each gender. Edit the weight as required.

### 14.1.4.3 Measuring Gender-Defined Bird Weights, Customized/Industrial Standard Curve

1. Go to Scale > Bird Scale Setting

BIRD SCALE SETTING	
Weighing Method	Auto
Scale 1	Female
Scale 2	Female
Scale 3	Male
Scale 4	Male

2. In Weighing Method, select Curve.

3. Go to Scale > Bird Scale Setting > Help. Define the parameters (option).

BIRD SCALE SETTING	
<b>Female</b>	
Upper Range [%]	10
Lower Range [%]	15
<b>Male</b>	
Upper Range [%]	15
Lower Range [%]	10

- Male/Female: The upper/lower range parameters defines the range of weights that are recorded. The weights of birds that exceed differ from the bird curve by these amounts are discarded. Note that the default range of the female and male bird are reversed.

4. Go to Scale > Bird Weight > Help.



BIRD WEIGHT	
<b>FEMALE</b>	
Curve Offset	0.00
Select Curve	Cobb500SDOt
<b>MALE</b>	
Curve Offset	0.00
Select Curve	CobbMV

5. Define the parameters:

- Curve Offset: Enter the factor used to adjust the weight curve. This amount is added to the curve. Range: -4.40 to +4.41 Kg/Lb.
- Select Curve:
  - Custom: the Bird Weight screen displays a generic curve for each day's target weight. You can edit the weight as required.
  - Factory default curve: The Bird Weight screen displays each day's target weight using an industry standard. These data points are read-only. Note that there are different curves for female or male birds.

6. Go to Scale > Bird Weight.

BIRD WEIGHT		
Day	Female	Male
0	0.09	0.10
7	0.33	0.31
14	0.63	0.66
21	0.90	1.06
28	1.21	1.46

- The Bird Weight screen displays the target weight for the current growth day for each gender.
  - If you selected Custom in Help, edit the fields as required.
  - If you selected an industrial standard, all fields are read-only.
- Note: If you select Custom, the controller saves all changes that you make to the fields. Meaning that after configuring a customized curve, you can go to the Help, select an industrial curve, and then go back and select Custom. The curve that you defined will reappear.

### 14.1.5 BIRD CURVE/BIRD WEIGHT

This section describes the Bird Scale Settings for Broiler mode. Refer to Breeder and Layer Mode appendices to view the function for those modes.

- Bird Curve, Version 6.18 and Below
- Bird Weight, Version 6.19

### 14.1.5.1 Bird Curve, Version 6.18 and Below

This screen displays the expected bird weight according to growth day for broilers, turkeys, or breeders.

.Only Broilers/ Layers Mode supports this function.

BIRD CURVE		
Day	Female Weight	Male Weight
1	0.11	0.13
7	0.31	0.35
14	0.66	0.70
21	1.26	1.54
28	2.07	2.73
35	3.15	4.27
42	4.45	6.15
49	5.95	8.22
Now	1.87	2.44

- Edit the growth days and weights for the bird curves to fit your requirements.

### 14.1.5.2 Bird Curve Help | Set Definitions

② While viewing the *Bird Curve* menu: Press *HELP*, select *SET* and press *ENTER*.

BIRD CURVE	
Bird Curve Offset	0.2

- **Bird Curve Offset:** Enter the factor used to adjust the weight curve. This amount is added to the Reference weight field. 0.0 – 10.0 Kg/Lb.

### 14.1.5.3 Bird Weight, Version 6.19

This screen displays the expected bird weight according to growth day. Which screen is displayed depends on the curve.

- Bird Weight Screens
- Bird Weight Help | Set Definitions

#### 14.1.5.3.1 Bird Weight Screens

- Auto Method

BIRD WEIGHT AUTO METHOD	
Current Weight	1.00

- If you selected Auto in Bird Scale Setting, the Bird Weight screen displays the target weight for the current growth day. You can edit the weight as required.
- Custom Weight

CUSTOM CURVE	
Day	Weight
0	0.00
1	0.00
2	0.00
3	0.00
4	0.00
5	0.00

- If you selected Custom in Bird Scale Setting: Edit the weights as required.
- Factory Default Curve

WEIGHT CURVE	
Day	Weight
0	0.09
1	0.13
2	0.16
3	0.20
4	0.24
5	0.30

- If you selected a Cobb or Robb Curve in Bird Scale Setting, the Bird Weight screen displays each day's target weight using an industry standard. These data points are read-only.

#### 14.1.5.3.2 Bird Weight Help | Set Definitions

- ① While viewing the Bird Weight menu: Press **HELP**, select **SET** and press **ENTER**.

*NOTE Auto method does not feature a help screen.*

BIRD WEIGHT	
Curve Offset	0.00

- **Curve Offset:** Enter the factor used to adjust the curve. This amount is added to the "Now" field. Range: -2.000 – 2.000 Kg / -4.40 - 4.41 Lb.

#### 14.1.6 HISTORY

The scale history shows bird weight statistics. You can review daily data for each scale, or separately.

- History, Version 6.18 and Below
- History, Version 6.19

##### 14.1.6.1 History, Version 6.18 and Below

- In Version 6.17 and below, the unit records the data of up to two-bird scales; if you have more than one scale-1, data is combined.
- In Version 6.18, the controller records up to four scales.

*NOTE Only Broiler/Layers Mode supports this function.*

HISTORY					
Day	Avg.	NO.	S.D.	Unif.	C.V
17	0.000	0	0.000	0	0
18	0.000	0	0.000	0	0
19	0.000	0	0.000	0	0
20	0.000	0	0.000	0	0
21	0.000	0	0.000	0	0
22	0.000	0	0.000	0	0
23	0.000	0	0.000	0	0
24	0.159	1	0.000	100	0
25	0.000	0	0.000	0	0
26	0.000	0	0.000	0	0

Figure 32: Version 6.17 or below

HISTORY									
Day	Avg.	Scale1	Scale2	Scale3	Scale4	NO.	S.D.	Unif.	C.V
17	0.000	0.000	0.000	0.000	0.000	0	0.000	0	0
18	0.000	0.000	0.000	0.000	0.000	0	0.000	0	0
19	0.000	0.000	0.000	0.000	0.000	0	0.000	0	0
20	0.000	0.000	0.000	0.000	0.000	0	0.000	0	0
21	0.000	0.000	0.000	0.000	0.000	0	0.000	0	0
22	0.000	0.000	0.000	0.000	0.000	0	0.000	0	0
23	0.000	0.000	0.000	0.000	0.000	0	0.000	0	0
24	0.159	0.000	0.000	0.000	0.000	1	0.000	100	0
25	0.000	0.000	0.000	0.000	0.000	0	0.000	0	0
26	0.000	0.000	0.000	0.000	0.000	0	0.000	0	0

Figure 33: Version 6.18

- If you select **SEXED** weighing, the history includes average data for the combined scales, and on the next screens separate data for each scale.
- If you select **MIXED** weighing, the history includes average data for all birds, and separate male and female data for Scale 1 and for Scale 2.
  - Use the arrow keys to scroll to the separated scale data, or up and down for data that is off screen.
  - The average and the number of weights are the usual definition. The Standard Deviation is the usual biased estimator (see a suitable textbook on statistical measurements). The Uniformity is the industry standard 10% uniformity (number of birds per 100 within 10% of the average weight), and the Coefficient of Variation or C.V. is the normalized standard deviation (standard deviation divided by average times 100 %.)

#### 14.1.6.2 History, Version 6.19

HISTORY									
Day	Avg.	D.Gain	Unif.	No.	Scale1	D.Gain	Unif.	No.	
1	0.00	0.00	0.00	0.00	0.00		0.00	0.00	
2	0.00	0.00	0.00	0.00	0.00		0.00	0.00	
3	0.00	0.00	0.00	0.00	0.00		0.00	0.00	

- The D. Gain shows difference between the current average weight and the previous day's average weight; the data comes from all the scales.
- No daily gain is shown for individual scales.

## 14.2 Test, Version 6.17 and Below

This section is a real-time table to show the statuses of all scales connected to the controller. Make sure that all statuses are O.K. If any of them show a different status, the scale is not installed properly. Unused positions can also show O.K.

1. In *Scale > Scale Layout* (refer to page 103), select the required scale types.
2. In *Scale > Test*, test the scales as required.

TEST				
	- 1 -	- 2 -	- 3 -	- 4 -
Type	Scale-1	Scale 2	Scale 3	Scale 4
A/D	2024	2010	1891	1893
Weight	0.222	35.768	0.000	0.000
Status	O.K.	O.K.	O.K.	O.K.

## 14.3 Vent & Curtain Levels Help | Set Definitions Version 6.18 or Below

- ② While viewing the *Vent & Curtain Levels* menu: Press **HELP**, select **SET** and press **ENTER**.

SYSTEM PARAMETERS	
<b>CURTAINS</b>	
Stop Fans, Curt. Move (total %)	30
1st Day for 2nd Vent to Oper.	-2
1st Level for 2nd Vent to Oper	1
<b>ATTIC</b>	
Minimum Attic Temp. To Operate	75
Operate Until Level	10
Operate From Time	0:00
Operate To Time	0:00
Max Temperatur to Disable Attic	100.0

### Curtains

- **Stop Fans, Curtain Move (total %):** Commands controller to stop fans during curtain movements when total of all curtains is less than the total percent set in this parameter. For example, 3 curtains at 40% each total 120% for this parameter. Default: 30%
- **1<sup>st</sup> Day for 2<sup>nd</sup> Vent to Operate:** Set the day the second vent begins operating. Default: 1.

**NOTE** You can set negative days.

- **1<sup>st</sup> Level for 2<sup>nd</sup> Vent to Operate:** Set the level the second vent begins operating. Default: 1

### Attic

- **Minimum Attic Temperature To Operate:** Set the minimum temperature to activate the attic operation.
- **Operate Until Level:** Set the maximum ventilation level for attic operation.
- **Operate From/To Time:** Set the time frame for attic operation.

**NOTE** If one of the above options is relevant, the Attic is enabled.

- **Maximum Temperature to Disable Attic:** Set the maximum attic temperature to stop using attic ventilation. This setting can prevent the heating effect in the growing space being too high resulting in overheating.

#### 14.4 Breeder Nest Function, Version 6.18 and Below

Nests				
Num	Open Time	Duration	Close Time	Duration
1	0:00	0	0:00	0
2	0:00	0	0:00	0
3	0:00	0	0:00	0
4	0:00	0	0:00	0

1. In Installation > Relay Layout designate up to four relays (each) as Nest Open and Nest Close relays.
2. In Device > Nest, define the parameters:
  - **Open Time:** The time each Nest lines' doors open.
  - **Duration:** The amount of time required for the Nests to open.
  - **Close Time:** The time each Nest lines' doors close.
  - **Duration:** The amount of time required for the Nests to close.

# 15 Warranty

## Warranty and technical assistance

Munters products are designed and built to provide reliable and satisfactory performance but cannot be guaranteed free of faults; although they are reliable products they can develop unforeseeable defects and the user must take this into account and arrange adequate emergency or alarm systems if failure to operate could cause damage to the articles for which the Munters plant was required: if this is not done, the user is fully responsible for the damage which they could suffer.

Munters extends this limited warranty to the first purchaser and guarantees its products to be free from defects originating in manufacture or materials for one year from the date of delivery, provided that suitable transport, storage, installation, and maintenance terms are complied with. The warranty does not apply if the products have been repaired without express authorization from Munters, or repaired in such a way that, in Munters' judgment, their performance and reliability have been impaired, or incorrectly installed, or subjected to improper use. The user accepts total responsibility for incorrect use of the products.

The warranty on products from outside suppliers fitted to Platinum Pro/Rotem Pro, (for example sensors, analog inputs, cables, etc.) is limited to the conditions stated by the supplier: all claims must be made in writing within eight days of the discovery of the defect and within 12 months of the delivery of the defective product. Munters has thirty days from the date of receipt in which to take action, and has the right to examine the product at the customer's premises or at its own plant (carriage cost to be borne by the customer).

Munters at its sole discretion has the option of replacing or repairing, free of charge, products which it considers defective, and will arrange for their dispatch back to the customer carriage paid. In the case of faulty parts of small commercial value which are widely available (such as bolts, etc.) for urgent dispatch, where the cost of carriage would exceed the value of the parts, Munters may authorize the customer exclusively to purchase the replacement parts locally; Munters will reimburse the value of the product at its cost price.

Munters will not be liable for costs incurred in demounting the defective part, or the time required to travel to site and the associated travel costs. No agent, employee or dealer is authorized to give any further guarantees or to accept any other liability on Munters' behalf in connection with other Munters products, except in writing with the signature of one of the Company's Managers.

**WARNING!** *In the interests of improving the quality of its products and services, Munters reserves the right at any time and without prior notice to alter the specifications in this manual.*

The liability of the manufacturer Munters ceases in the event of:

- dismantling the safety devices;
- use of unauthorized materials;
- inadequate maintenance;
- use of non-original spare parts and accessories.

Barring specific contractual terms, the following are directly at the user's expense:

- preparing installation sites;
- providing an electricity supply (including the protective equipotential bonding (PE) conductor, in accordance with CEI EN 60204-1, paragraph 8.2), for correctly connecting the equipment to the mains electricity supply;
- providing ancillary services appropriate to the requirements of the plant on the basis of the information supplied with regard to installation;
- tools and consumables required for fitting and installation;
- lubricants necessary for commissioning and maintenance.

It is mandatory to purchase and use only original spare parts or those recommended by the manufacturer.

Dismantling and assembly must be performed by qualified technicians and according to the manufacturer's instructions.

Requests for technical assistance and spare parts can be made directly to the nearest [Munters office](#).

