

Temperature Controller

CC24-7 *ELITE*

USER'S MANUAL



WARNINGS

The warranty can be void if this product is used in a manner not specified by the manufacturer.

Every effort has been made to ensure that this manual is complete, accurate and up-to-date. The information contained in it is however subject to change without notice due to further developments.

TABLE OF CONTENTS

1. INTRODUCTION	5	4.7.8. Feeder Relay.....	20
1.1. Precautions	5	4.8. Test Mode.....	21
1.2. Symbols of the Manual	5	4.9. Version	21
1.3. Controller's Overview	5	5. TEMPERATURE SETTINGS	22
1.3.1. Description of the Controller.....	5	5.1. Temperature Set Point	22
1.3.2. What's New	6	5.1.1. Set Point Settings	22
1.3.3. Main Features.....	6	5.1.2. Set Point Curve.....	22
2. MOUNTING INSTRUCTIONS	7	6. VENTILATION & COOLING	23
2.1. Installing the Controller on the Wall	7	6.1. Minimum Ventilation.....	23
2.2. Connections	7	6.1.1. Minimum Ventilation Cycles	23
2.2.1. Main Wiring.....	7	6.1.1.1. Principle of Operation.....	23
2.2.2. Alarm Connection	7	6.1.1.2. Settings	23
2.2.3. Probe Inputs	7	6.1.2. Minimum Ventilation Curve.....	24
2.2.4. 0-10V Output Connection	7	6.1.2.1. Principle of Operation.....	24
2.3. Installing Static Pressure Sensor Tubings.....	8	6.1.2.2. Min Vent. Curve Settings	24
3. USER INTERFACE	11	6.1.3. Min Vent. Ramp & Compensation.....	25
3.1. Location of the Controls.....	11	6.1.3.1. Stage 1 On Time Ramp	25
3.2. Parameter Adjustment	11	6.1.3.2. On Time Compensation Below the Set Point 25	
3.3. Status LEDs	11	6.2. Fan Stages	26
4. CONTROLLER SETUP	12	6.2.1. Principle of Operation	26
4.1. Time & Date	12	6.2.1.1. On/Off Fan Stages.....	26
4.1.1. Day / Night Times	12	6.2.1.2. Variable Outputs	26
4.1.2. Adjusting Improper System Time.....	12	6.2.1.3. 0-10V Ventilation Output	27
4.2. Password	12	6.2.2. Settings.....	27
4.3. Controller Programs & Seasonal Settings.....	13	6.2.2.1. Fan Stage Settings	27
4.3.1. Selecting a Program.....	13	6.2.2.2. 0-10V Output Fan Settings.....	28
4.3.2. Copying / Pasting a Program Configuration..	13	6.3. Tunnel Curtain	29
4.4. Measuring Units.....	13	6.3.1. Static Pressure Curtains	29
4.5. Installation Setup	14	6.3.1.1. Principle of Operation.....	29
4.6. Probe Settings	17	6.3.1.2. Settings	30
4.6.1. Probe Assignment	17	6.3.2. Timer-Based Curtain	31
4.6.2. Probe & Water Meter Calibration.....	17	6.3.2.1. Principle of Operation.....	31
4.7. Relay Assignment	18	6.3.2.2. Settings	31
4.7.1. Principle of Operation	18	6.4. Inlets & Vent Doors	32
4.7.2. Heaters' Relay Assignment.....	18	6.4.1. Inlet on External SB Modules	33
4.7.3. Fan Stage Relay Assignment	18	6.4.1.1. Settings	34
4.7.3.1. Ventilation Relays : Principle of Operation. 18		6.4.2. Pressure-based Vent Doors.....	35
4.7.3.2. Fan Stage Relay Settings.....	18	6.4.2.1. Principle of Operation.....	35
4.7.3.3. Variable Outputs & Timer Settings.....	19	6.4.2.2. Settings	36
4.7.3.4. Copying / Pasting Fan Stage Relays	19	6.4.3. Timer-Based Vent Doors	37
4.7.4. Curtain, Vent Door & Attic Relays	19	6.4.3.1. Principle of Operation.....	37
4.7.5. Clock Output Relays	20	6.4.3.2. Settings	37
4.7.5.1. Clock Output Relays	20	6.4.4. Attic Vent	38
4.7.5.2. Selecting Common Relays	20	6.4.4.1. Pressure-based Attic Vent	38
4.7.6. Cooling Output Relays	20	6.4.4.2. Timer-based Attic Vent	39
4.7.7. Backup Box Relay	20	6.5. Cooling Outputs.....	40
		6.6. Natural Ventilation.....	41
		6.6.1. Principle of Operation	41
		6.6.2. Transition Between Natural & Tunnel Ventil. 41	
		6.6.3. Settings.....	42

7.	HEATERS	43	13.	TECHNICAL SPECIFICATIONS	57
7.1.	Heating Stages	43	14.	TRANSFER MENU	58
7.2.	Heater Curve	44	14.1.	Screen Contrast	58
7.2.1.	Principle of Operation	44	14.2.	Communication Speed	58
7.2.2.	Settings	44	14.3.	Update/Backup Process.....	58
7.2.3.	Copy/Paste Heat Curves	44	15.	INSTALLATION REPORT	59
7.3.	Heat Mats (0-10V Heating Outputs)	45	16.	INDEX	70
8.	LIGHTS	46			
8.1.	Principle of Operation	46			
8.2.	Activating Additional 0-10V Light Outputs	46			
8.3.	Light Program Settings.....	46			
9.	CLOCK OUTPUTS	47			
10.	RELATIVE HUMIDITY (RH) CONTROL	49			
10.1.	Principle of Operation	49			
10.1.1.	RH Comp. on the Min. Ventilation Intensity .	49			
10.1.2.	RH Comp. with Heating Outputs	49			
10.1.3.	RH Comp. on the Mist Output.....	49			
10.2.	Settings	49			
11.	ALARMS	50			
11.1.	Alarm Log	50			
11.2.	Alarm Conditions & Settings.....	50			
11.2.1.	Temperature Alarms	51			
11.2.2.	Static Pressure Alarms.....	52			
11.2.2.1.	SP Alarm Settings:	52			
11.2.2.2.	Low SP Alarm Relay	52			
11.2.2.3.	Hi Static Pressure Alarm Settings	52			
11.2.3.	Water Spill Alarms.....	53			
11.2.4.	Feeder Alarms	53			
12.	MONITORING FUNCTIONS	54			
12.1.	Current Conditions	54			
12.2.	History.....	54			
12.3.	Monitoring the Animal Age & Number	55			
12.4.	Message Center	56			
12.4.1.	Message Log	56			
12.4.2.	Clearing the Message Log	56			
12.4.3.	Servicing Schedule	56			
12.4.4.	Relay Run Time.....	56			

1. INTRODUCTION

1.1. Precautions

 **WARNING: Read and save these instructions!**

Safety may be jeopardized if the equipment is used in a manner not specified by the manufacturer. Carefully read and keep the following instructions for future reference.

We strongly recommend installing supplementary natural ventilation as well as a backup thermostat on at least one cooling stage.

Although fuses at the input and outputs of the controller protect its circuits in case of an overload or over-voltage, we recommend installing an additional protection device on the controller's supply circuit.

The room temperature where the controller is located must always remain between 32°F and 104°F (0°C to 40°C). Indoor use only!

To avoid exposing the controller to harmful gases or excessive humidity, it is preferable to install it in a corridor.

If the equipment is used in a manner not specified by the manufacturer, the protection provided by the equipment may be impaired.

Do not spray water on the controller! In order to clean the control, wipe it with a damp cloth.

 **Before servicing or cleaning unit, switch power off at service panel and lock the switch disconnecting means to prevent power from being switched accidentally. When the service disconnecting means cannot be locked, securely fasten a prominent warning device, such as a tag, to the service panel.**

1.2. Symbols of the Manual



Warning. Read the following text carefully; it contains important information which, if ignored, may cause the controller to operate improperly.



High Voltage. Hazard of electrical shock. Read the message and follow the instructions carefully.



Pay attention. The following text contains very useful information.



Both direct and alternating current (AC/DC).



Direct current (DC).



Alternating current (AC).



Earth Ground Terminal
Primarily used for functional earth terminals which are generally associated with test and measurement circuits. These terminals are not for safety earthing purposes but provide an earth reference point.

For Customer Use: Enter below the serial number located on the side of the alarm system and keep this information for future reference.

Model:	CC24-7 ELITE
Serial number:	_____
Date installed:	_____

1.3. Controller's Overview

1.3.1. Description of the Controller

The CC24-7 ELITE is an electronic device used for environmental control in livestock buildings. It allows to maintain a specified target temperature by controlling the operation of ventilation and heating equipment. The controller can operate the following inputs & outputs:

OUTPUTS:

- 100 On/Off relays located in external relay panels.
- 8 heating stages (and the possibility to simulate up to 16 stages);
- 16 fan stages;
- 8 clock outputs;
- 1 tunnel curtain;
- 4 natural ventilation curtains;
- 1 stir fan output;
- 4 cooling outputs;
- 1 inlet output used to connect up to 10 external air inlet modules (SB modules) or to connect a vent door.
- 1 inlet output used to connect an attic vent, a supplementary sidewall vent (vent door) or a supplementary tunnel curtain.
- 2 Variable-speed outputs;
- 4 0-10V outputs used for:
 - heat mats;
 - lights;
 - fans.

INPUTS:

- 8 inside temperature probes;
- 1 outside temperature probe;
- 1 static pressure sensor;
- 1 humidity sensor;
- 10 water meters;
- 2 dry contact inputs to monitor:
 - 1 feeder;
 - 1 device for the message center.

 **Refer to the end of this manual to connect the sensors and loads.**

1.3.2. What's New

The controller now uses a new and improved core platform. Here's the list of improvements related to this new platform:

Screen contrast — The screen contrast can now be modified directly from the TRANSFER menu.

Stability of the screen contrast — The controller now ensures stability in the screen contrast when the display is submitted to temperature changes.

A-BOX Ready — The high speed communication protocol required to connect the controller to the A-BOX system can now be activated from the TRANSFER menu. There is no need to change a microchip inside the controller to change the communication speed.

Easier firmware updates — Platform firmware updates can now be downloaded from a USB card (see TRANSFER menu). There is no need to change a microchip inside the controller to make this update.

Simplified firmware — The new core platform now uses one firmware only.

Memory card — The classic memory card (Config200 card) has been replaced by a standard USB drive (included with the controller).

Improved navigation process — Scroll bars, pop-up menus and page-up/ page-down functions were added to ease navigation inside the menus.

Less controller reset — Instead of resetting when there is instability in the power supply, the controller now displays a "Zero Crossing" alarm message.

Event buffer — The controller's event log can be saved on the USB card (see TRANSFER menu).

1.3.3. Main Features

Very large LCD display — A large screen provides an efficient interface for displaying, monitoring and adjusting the parameters.

4 Controller programs — The controller has 4 programs to control the room temperature. You can thus choose a program that suits the current age of the animals for instance.

Status LEDs — Pilot lights indicate the status of the controller's outputs, allowing you to monitor the system's operation without having to enter the building.

Removable connectors — You can remove the connectors from the main board to make the connections.

Minimum ventilation cycle — When ventilation is not required to reduce the room temperature, the fan outputs can run either continuously or intermittently to reduce the humidity level and supply oxygen to the room.

Probe readings recorded for past days — The controller keeps a daily record of the minimum and maximum readings of the static pressure and humidity probes for the past 75 days. The minimum and maximum readings of each individual temperature probe is also recorded daily for the past 7 days.

Water monitoring — Ten pulse inputs are provided to monitor the water consumption. The controller keeps a daily record of the water consumption for the past 60 days.

Alarm management — Alarms are provided for high-low temperatures, defective probes and other system failures. The controller keeps in memory the 25 previous alarm conditions.

Eight independent temperature probe inputs — Eight inside temperature probes can be connected to the controller in order to obtain an accurate reading of the average house temperature and a faster reaction time.

Humidity Control — The control offers many ways to compensate for high or low humidity levels.

0-10V outputs — Four 0-10V outputs can be used to activate additional fans, heat mats, or lights.

Control of the air inlet movement — If the controller is used in combination with one or more air inlet modules, the movement of air inlets can be coordinated with the operation of the fans, using a potentiometer located on the panel drive. This allows the air inlets to be adjusted correctly, without the influence of uncontrollable factors such as wind or air from adjoining rooms.

Recuperation of the warm air in the attic — In order to make energy savings, the controller can extract the warm air from the attic and send it back into the room.

Natural ventilation — The controller can control up to 4 curtains located in independent natural zones.

Tunnel curtain control — An endwall curtain can be controlled according to the room temperature or according to the static pressure level in the house.

Vent doors — The controller can open and close vent doors according to a timer at the start-up of each fan stage or it can coordinate the vent door operation with the static pressure level of the room.

Password protection — A password is used to restrict access to some of the controller setup functions.

Backup battery — A backup battery allows the unit to keep time in case of a power failure.

Overload and overvoltage protection — Resettable fuses are provided at low-voltage inputs and outputs of the controller to protect its circuitry in the case of an overload or overvoltage.

Computer control — The controller can be connected to a computer, thus making it possible to centralize the management of information and diversify control strategies.

Test mode — The test mode allows the user to simulate temperature changes and verify the performances of the controller.

2. MOUNTING INSTRUCTIONS

2.1. Installing the Controller on the Wall

Fasten the two metal brackets on the mounting holes located behind the controller using six screws. Then, mount the enclosure on the wall using four other screws. Leave a clearance of at least 16" to the left of the enclosure to allow the cover to be removed for maintenance.

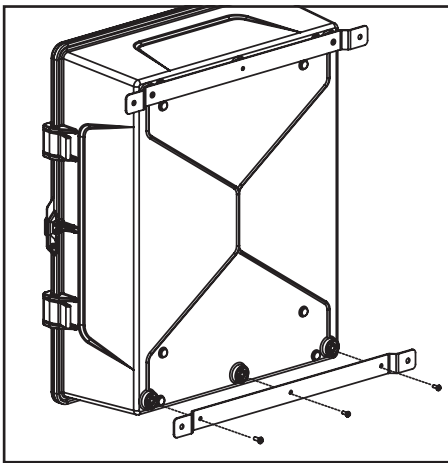

2.2. Connections

2.2.1. Main Wiring

Refer to the wiring diagram enclosed with this user's manual to connect the controller. Drill holes at the bottom of the enclosure to pass the wires and install watertight connectors to prevent water from entering in the enclosure. Do not make any holes at the side and top of the enclosure.

⚠ All wiring must be done by an authorized electrician and must comply with applicable codes, laws and regulations. Make sure power is off before doing any wiring to avoid electrical shocks and equipment damage.

2.2.2. Alarm Connection

There are two types of alarms on the market. One type activates when current is cut off at its input; the other type of alarm activates when current is supplied at its input. For an alarm of the first type, use the NC terminal as shown on the wiring diagram. For an alarm of the second type, use the NO terminal.

2.2.3. Probe Inputs

Probes operate at low voltage and are isolated from the supply. Make sure that probe cables remain isolated from all high voltage sources. In particular, do not route the probe cables through the same electrical knockout as other cables. Do not connect the shield from the probe cable to a terminal or a ground.

Extending a probe: Each probe can be extended up to 500 feet (150 meters).

To extend a probe: Use a shielded cable of outside diameter between 0.245 and 0.260 in (6.22 and 6.60 mm) (the cable dimensions should not be under 18 AWG) to ensure the cable entry is liquid tight. **Do not ground the shielding.**

It is preferable to solder the cable joint to ensure a proper contact between the two cables.

⚠ Do not run probe cables next to other power cables. When crossing over other cables, cross at 90°.

Defective probes: An alarm is generated when a defective probe is detected. Defective probes are identified in the "Alarm Log" menu. Refer to chapter 11 for further information on the alarms.

2.2.4. 0-10V Output Connection

It is recommended to use a 18 to 22 AWG wire to connect the devices to the 0-10V outputs. This type of output can be used to connect various devices such as heat mats or fans.

2.3. Installing Static Pressure Sensor Tubings

The integrated static pressure sensor is a very robust and reliable tool for controlling your vent door openings. However, the installation requires some care in order to ensure that the controller functions properly. 10' of clear tubing and insect filters are provided with the controller. Insert a plastic insect filter at the end of each tube as illustrated. Leave a clearance between the end of the tube and the plastic filter to avoid obstructing the tube.

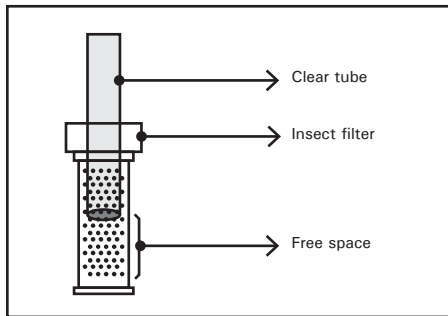

Choosing a Good Reference

The purpose of the static pressure sensor is to maintain a slight vacuum inside the building as compared to the outside atmospheric pressure. This pressure difference (usually in the order of 0.03 to 0.09 inches of water) induces the desired air speed at the vent door for an optimum airflow distribution. It is important to understand that the pressure difference to be controlled is the one that exists between either side of the vent door wall. We must therefore be sure that the reference is representative of the current outside pressure.

a) Using the Attic as a Reference

The attic is usually considered a good reference as long as the following conditions are observed:

i) The attic must have sufficient openings on all sides of the building to allow outside air to permeate it and ensure that no permanent pressure difference builds up between the attic and outside air (usually, an attic with openings covering 4% of its area is sufficient).

To test the suitability of the attic as a reference, place the "reference" tube in the attic and the "room" tube outside or in a room with wide openings to the outside (for example, the entrance of a house with wide open doors so the pressure in the room is the outside pressure). The pressure difference must be near zero. You'll notice that the wind may induce a pressure difference for short periods of time (because of a "breathing" effect). This is the reason the pressure sensor has a time delay on any action.

The attic is a good reference if you don't see any permanent pressure difference.

ii) The attic must be airtight with respect to the adjacent livestock floor. This way, no pressure difference is induced between the reference (attic) and outside pressure due to the action of a fan. To test the airtightness of the attic with respect to the ventilated room, place the reference tube in the attic and the room tube outside or in a room with wide openings to the outside. There should be no sensitive pressure drop when you activate or deactivate the fans in the space next to the attic. No vacuum should build up in the attic.

Testing the suitability of the attic

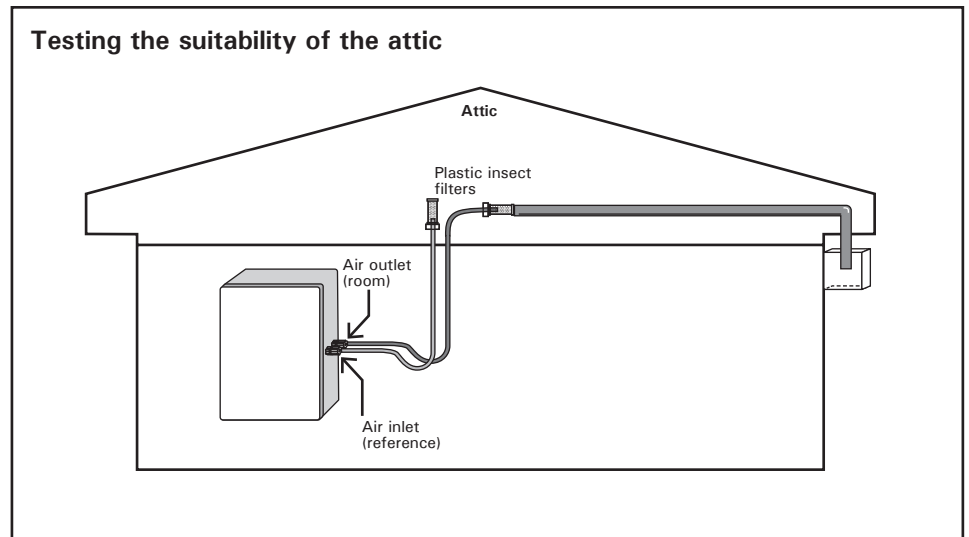

Installation of an Extended Reference Tube into the Attic: It may happen that the supplied 10' of clear tubing isn't long enough to close the airflow circuit between the room and the attic (reference). In this case, we recommend installing the controller within 10' of the room to be controlled. Use the clear tubing to reach the room and extend the reference tube with a larger pipe or tube (1" pipe is good) to the location of the reference (see diagram). At the reference location, the opening of the pipe should be as large as its section. It should point downwards, using an elbow if necessary, and be protected from any direct airflow from the outside. The use of a coarse screen is recommended to stop insects from plugging up the pipe. Once the installation is completed, perform the above tests to validate the reference.

Averaging Two Sides of the Building: Some attics are not suitable as a reference because they have eave openings only on one side or they have only ridge openings. In this case, we recommend using a reference box in the attic connected to extended reference tubes. This box should be airtight and mounted in the center of the attic. It should be connected to two 1" tubes that extend to either side of the building at 25" from the building end. Connect the supplied clear tube to the reference side of the pressure sensor and make a loop close to the controller. Connect the extended reference tube to the box.

Testing the airtightness of the attic

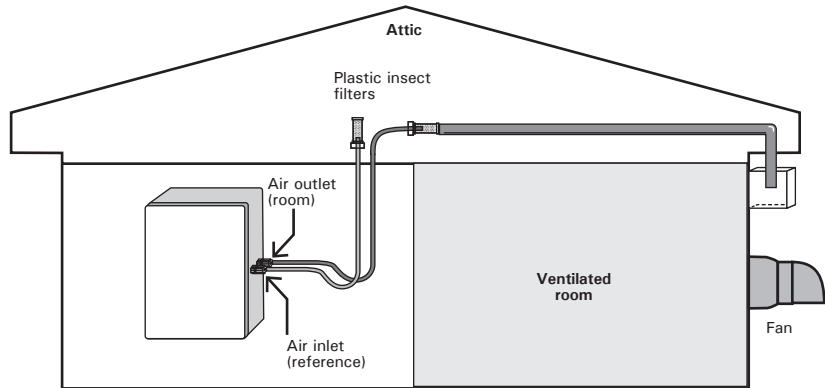

Installing an extended reference tube in the attic

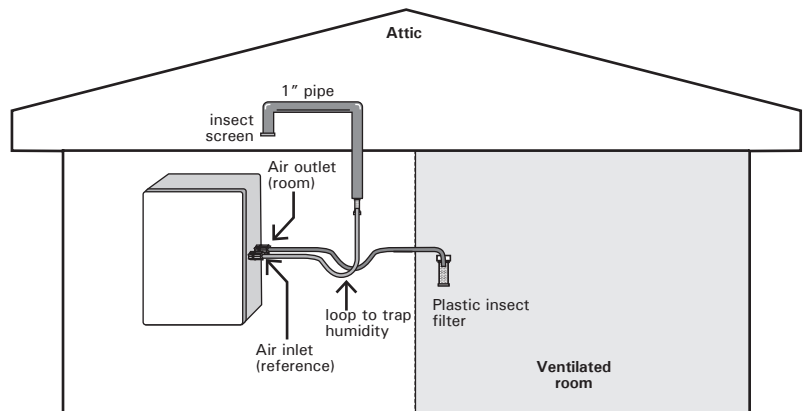

Averaging 2 sides of the building

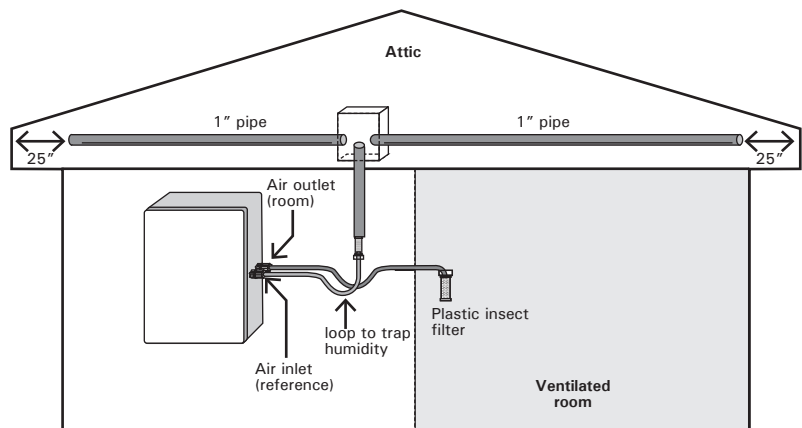

b) Using An Extended Outdoor Reference

If, for any reason, the attic fails to meet one or both of the above two conditions, or if the building does not have an attic, you should consider using an outside reference.

A good place to start is on the inlet side of the room, at a minimum distance of 25 feet from any corner of the building to avoid a wind vacuum effect. The tube should be installed in a box or a restricted space to avoid undesirable sun and wind effects. Avoid mounting the box in the airflow path into the building. Stay at least 2 feet from the inlet opening. The box should be filled with mineral wool

to absorb most of the fluctuations caused by the wind. Make at least thirty holes of 1/4" on the sides and bottom of the box (do not make holes on the top).

Use the clear tube to reach the room and make a moisture trap loop. On the reference side, use the supplied clear tube, make a loop and join the extended reference tube. The extended reference tube should have a bigger diameter (1" is good). Run the extended tube to the location of the reference. Make a loop on the way to trap moisture if undesirable airflows occur. This trap should include a plug to drain the water. Try to run the pipe inside the building as much as possible.

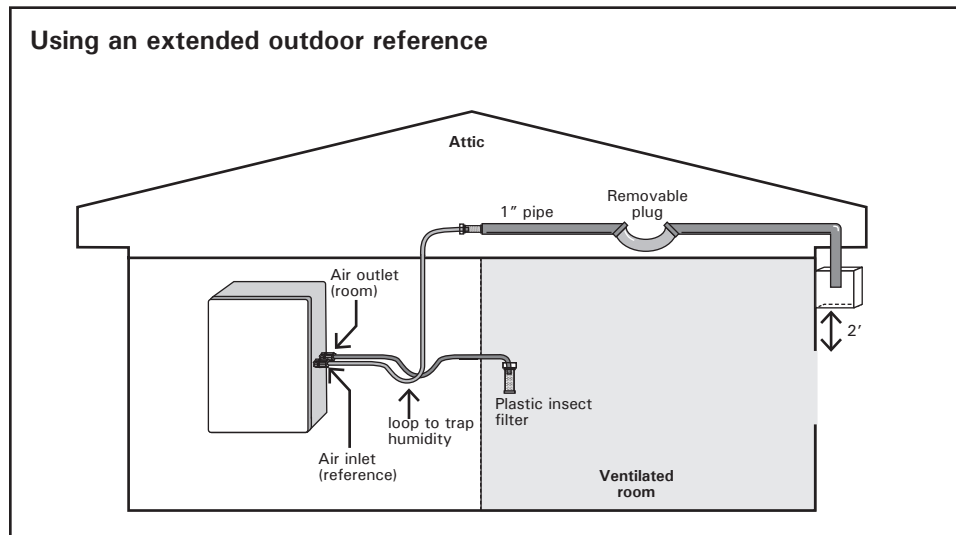

3. USER INTERFACE

3.1. Location of the Controls

MAIN LCD SCREEN — The large LCD screen is used to display the various parameters and menus. It automatically displays the Current Conditions menu after 4 minutes of inactivity and its contrast can be modified in the TRANSFER menu 14).

LED DISPLAY — This display either shows the current average room temperature and/or the static pressure level.

STATUS LEDs — The status pilot lights indicate the current status of the different stages and outputs. Refer to section 3.3 for further information about these LEDs.

ARROW KEYS — Use the arrow keys to select a parameter on screen. The right and left arrow keys can also be used to move through the display by pages in some menus (left=page-up, right=page-down).

ADJUSTMENT BUTTONS — Press + or - to modify the value of a parameter.

ENTER — Press Enter to access the selected menu.

BACK — Press BACK to return to the previous menu.

SHORTCUT KEYS — Press a shortcut key to access a predefined menu of the controller.

ALARM LOG — Press this key to access the "Alarm Log" menu.

USER-DEFINED SHORTCUT KEY — Press and hold the "User-defined shortcut key" 3 seconds to associate the selected menu with the shortcut key. The destination of this key can be changed anytime.

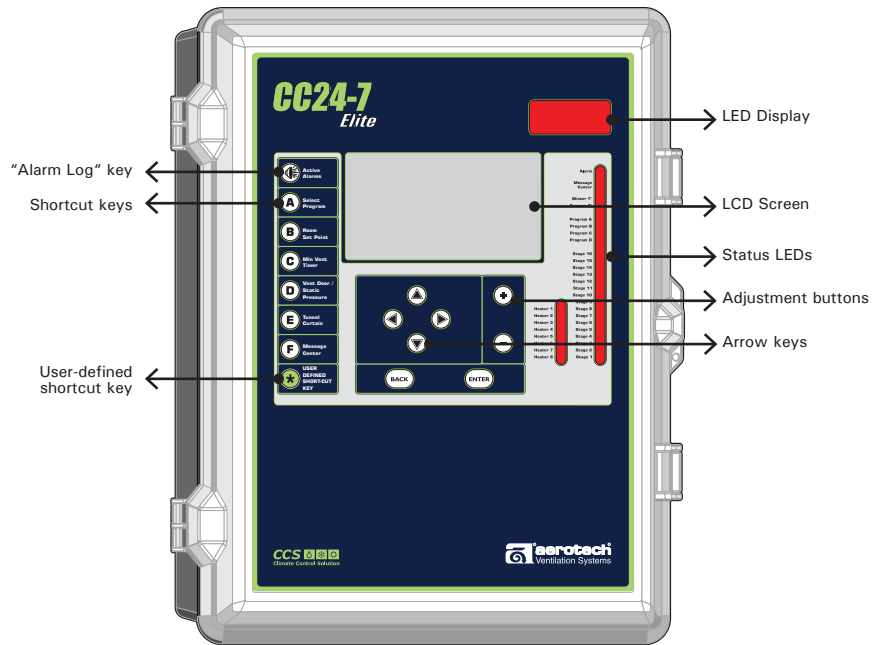

3.3. Status LEDs

LED	MEANING
ALARM	Turns on when an alarm condition is detected. Flashes when an alarm condition occurred and was re-established by itself.
MESSAGE CENTER	Turns on when a message is signaled in the message log menu. Indicates which seasonal parameters are currently in use.
PROGRAM A-D	Indicates which program is currently in use.
STAGE 1-16	Turns on when the selected fan stage is active.
HEATER 1-8	Flashes when one step of the heating output is operating (regular or high fire step). Turns on when both steps of the heating output are operating (regular and high fire steps). Off Time of the minimum ventilation timer.

3.2. Parameter Adjustment

When a parameter is selected, follow the instructions displayed at the bottom of the screen to change its value.

4. CONTROLLER SETUP

4.1. Time & Date

1. Select:

- » 23. Controller Setup
- » 4. Time and Date

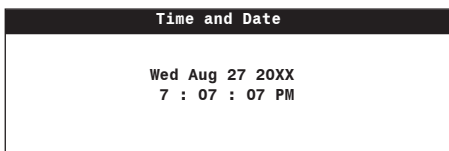

2. Press "Enter" to start editing the time and date. A pop-up window for adjusting the month is displayed.

 Use the +/- adjustment buttons to select and change a parameter inside a pop-up window. Do not use the arrow keys for this purpose.

3. Use the +/- adjustment buttons to select the current month from the scrolling list.

4. Press "Enter" to continue.

5. The day is now selected. Press the +/- adjustment buttons to change the current day.

6. Press "Enter" to continue.

7. The year is now selected. Use the +/- adjustment buttons to change the current year.

8. Press "Enter" to continue. A pop-up window for adjusting the time is then displayed.

9. Use the +/- adjustment buttons to set the hours.

10. Press "Enter" to continue.

11. The minutes are now selected. Use the +/- adjustment buttons to set the minutes.

12. Press "Enter" to continue.

13. The seconds are now selected. Use the +/- adjustment buttons to set the seconds.

14. Press "Enter" to validate the new time and date.

4.1.1. Day / Night Times

If night functions are used, you must specify at what time the day and night start and what is the transition time between both of them. The transition time is the interval of time over which the controller gradually switches from daytime to nighttime settings.

1. Select:

- » 23. Controller Setup
- » 6. Day / Night Time*

* Available if night functions are enabled (sec. 4.5).

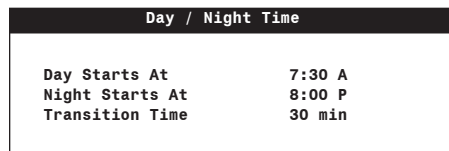

2. Set the day and night start times and the transition time between both of them.

4.1.2. Adjusting Improper System Time

When the notification message that follows is displayed onscreen you must set the correct time and date.

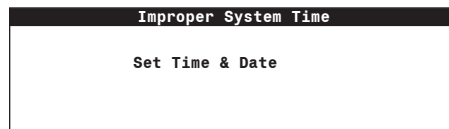

CAUTION: To ensure accurate feed data, history logs, and other important system information, you must set the correct time and date whenever prompted.

To adjust the time and date when the "Improper System Time" notification appears, follow the steps indicated in section "4.1. Time & Date"

Once the time and date has been adjusted, the notification message disappears, the system clock is set, and accurate data is ensured.

Note: The notification message repeatedly disappears and reappears until the time and date are set.

4.2. Password

This function allows identifying 2 different types of users. The password is made up of 4 digits and it is used to restrict access to certain functions of the controller. When a correct password is entered, the current user is identified.

Installer Password (default = 0-6-1-0)

The installer mode gives full access to all the controller functions. The installer password can be modified as explained below.

User Password (default = 1-1-1-1 & 2-2-2-2)

The user mode gives access to the basic functions of the controller. The controller automatically returns to the user mode after 15 minutes of inactivity. The user passwords cannot be modified.

1. Select:

- » 23. Controller Setup
- » 7. Password

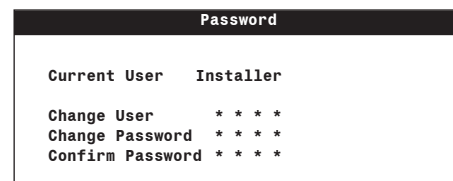

Entering a password:

1. Press Enter to display the password pop-up window.

2. Use the +/- adjustment buttons to enter the first digit of the password.

 Use the +/- adjustment buttons to select an change a parameter inside a pop-up window. Do not use the arrow keys for this purpose.

3. Press Enter to step to the next digit.

4. Proceed the same way to enter all 4 numbers.

Changing the installer password:

To change the password, enter the installer password first as explained above. The message "Change Password" will then be displayed. Change it if required.

4.3. Controller Programs & Seasonal Settings

Programs: The controller has 4 programs of temperature settings. Each program has its own probe and relay assignment to run fan stages 1-6 and heating stages (optional). Using programs is useful when different sections of the room are occupied in the course of a batch. Refer to section 4.5 to enable the programs.

Seasons: The temperature at which fan and cooling stages are activated can be set separately for summer and winter. You must select the current season as explained below.

 **Make sure the right program & season are selected before adjusting any parameter.**

4.3.1. Selecting a Program

1. Select

» 6. Program Selection—or press “A”

Program Selection	
Running program	Program A
Temperature Settings	Summer

2. Select the desired program. **Only the programs that have been enabled in the installation setup are available (sec. 4.5).*

3. Select the current season. The ventilation, heating and cooling outputs will run according to the parameter settings that are associated with this season.

4.3.2. Copying / Pasting a Program Configuration

Use the copy-paste function to duplicate the selection of probes that are used to measure the average room temperature and the selection of relays (regular & timer-based relays), and variable outputs that are used by fan stages 1 to 6 from a program onto another. This avoids repeating the same programming sequence several times.

1. Select:

- » 22. Relay and Probe Assignment
- » 21. Copy Paste

** This menu is only accessible from the installer mode (sec. 4.2).*

Copy / Paste	
Select item to copy:	Program
Copy from:	Program A
Paste to:	Program B
Confirm?	No

2. The prompt “Select item to copy” is displayed. Choose the “Program” option.

3. Set the following parameters:

Copy From — Select the source program. The one that will be duplicated.

Paste to — Select the target program. The one on which the copied program will be pasted.

Confirm — Once a different source and target programs are selected, select “Yes” to make the program copy. The message “Copy in progress” is displayed. Wait until the data transfer is over.

4.4. Measuring Units

1. Select:

- » 23. Controller Setup
- » 8. Units

Unit Selection	
Time Mode	AM/PM
Temperature	°F
Water	gal
Static Pressure	“WC

2. Select the proper measuring units:

Time display — AM/PM / 24 hours;

Temperature units — Celsius (Deg C) or Fahrenheit (Deg F).

Water — Gallons / Liters

Static Pressure — Inches of water (“WC) or Pascal (Pa).

 **Measuring units are common to all programs of the controller.**

4.5. Installation Setup

The following section shows how to customize the controller for your particular application. You will learn how to enable your controller's inputs and outputs, and how to set other basic functions. Normally, this setup needs to be done only once.

1. Select

- » 23. Controller Setup
- » 2. Installation*

* This menu is only accessible from the installer mode (sec. 4.2).

Installation	
Clear Alarms?	No
Number of T° Probes	8
Number of Water Meters	10
Number of Relays	40CS
Number of Inlets	10
Number of Fan Stages	16
Number of Cooling	4
Number of Programs	abcd
Number of Light Programs	8
Number of Heaters	8
Number of Natural	2
Number of Clocks	4
# of Program Clock 1	4
# of Program Clock 2	4
# of Program Clock 3	4
# of Program Clock 4	4
Clock 5 Mode	Start/Stop
Clock 6 Mode	Start/Run
Clock 7 Mode	Start/Rep.
Clock 8 Mode	Start/Rep.
Clock Increment	10 min
Use Night Set Point?	Yes
Use Set Point Curve?	Yes
Use Minimum Vent. Curve?	Yes
Use Heater Offset Curve?	Yes
Use Animal Age Function?	Yes
Use Heater Programs ?	Yes
Use Heater Hi / Lo	Yes
Use Tunnel ?	Yes
...	

Exit: Press Back Change: Press +/-
Press ▲▼ to select an item

Clear Alarms? — Select “Yes” to reset the Alarm Log.

Number of Inside T° Probes — Select the number of temperature probes that are connected to the controller. This parameter ranges from 1 to 8 probes.

Number of Water Meters — Select the number of water meter that are connected to the controller. This parameter ranges from 0 to 10 water meters. The first 2 water meters are directly connected to the main board of the controller; water meters 8 to 10 are connected to an external water meter module. Refer to the wiring diagram.

Number of Relays — Select the total number of relays provided by the external relay panels (10, 20, 30, 40, 50, 60, 70, 80, 90, 100, 16, 32, 48, 64, 40CS, 48CS, 80CS, 88CS, 96CS). *Select the CS option if your relay panel is compatible with the CS technology (current sensing relays).

Number of Inlets — If the inlets are connected to external inlet modules such as the SB 3000 or SB 3500 modules, specify how many inlets (or modules) are connected to the first inlet output. This parameter ranges from 0 to 10 inlets. *This parameter is available if the vent door mode is set to “Ext” below.

Number of Fan Stages — Select the number of fan stages. This parameter ranges from 1 to 16 stages. *The minimum number of fan stage is limited by the stage that is used to enter in tunnel ventilation. Refer to section 6.3.1 to select the first tunnel stage.

Number of Coolings (Mist) — Select the number of cooling outputs. This parameter ranges from 0 to 4 outputs.

Number of Programs — Select the number of controller programs. This parameter ranges from 1 to 4 programs — None=1 program; ab=2 programs; abc=3 programs; abcd=4programs.

Number of Light Programs — Select the number of light programs. This parameter ranges from 0 to 8 programs.

Number of Heaters — Select the number of heating stages. This parameter ranges from 0 to 8 stages.

Number of Naturals — Select the number of natural ventilation zones. This parameter ranges from 0 to 4 zones.

Number of Clocks — Select the number of clock outputs. This parameter ranges from 0 to 8 outputs.

of Program Clock x — Select the proper number of timer programs used by clock outputs 1-4. This parameter ranges from 1 to 4 programs.

Clock Mode — Select the operating mode of clock outputs 5 to 8:

Start/Run: the output stops after a user-defined run time.

Start/Stop: the output stops at a user-defined time of the day;

Start/Repeat: the clock output operates according to a timer which is repeated at regular intervals.

Clock Increment — The start & stop times of clock outputs can either be adjusted in increments of 1, 5 or 10 minutes. Select the desired time increment.

Use Night Set Point? — Select “Yes” to enable night settings.

Use Set Point Curve? — Select “Yes” to enable a curve to get an automatic adjustment of the set point over time.

Use Minimum Vent. Curve? — Select “Yes” to enable a curve to get an automatic adjustment of the minimum ventilation fan speed (or fan On Time) over time.

Use Heater Offset Curve? — Select “Yes” to enable a curve to get an automatic adjustment of the heaters’ start temperature over time.

Use Animal Age Function? — Select “Yes” to use functions that are based on the age of the animal age (curves, light programs, tunnel curtains, etc.) *This parameter is available if all curves are disabled above.

Use Heater Programs? — Select “Yes” to use separate heat settings for each program (probe and relay assignment); select “No” if these settings are common to all programs. *This parameter is available if heaters & programs are enabled above.

Use Heater Lo/Hi Fire? — Select “Yes” to activate the heating outputs’ Lo & Hi fire option. This function allows doubling the number of heaters. Refer to sec. 7.1 for further information. *This parameter is available if heaters are enabled above.

Use Tunnel? — Select “Yes” to enable the tunnel curtain.

Tunnel Mode — The tunnel curtain operates according to the static pressure level or uses a timer? **This parameter is available if the static pressure probe is enabled below.*

Vent Door Transition — Select the transition mode between lateral and tunnel ventilation **This parameter is available if the tunnel curtain is enabled and if the vent door operation is based on the static pressure.*

Open: vent doors fully open at the start-up of the first tunnel stage.

As is: vent doors remain in position at the start-up of the first tunnel stage (only available if the curtain operates according to the static pressure level).

SP: vent doors keep being controlled by the static pressure level during the transition (only available if the curtain operates in timer mode).

Tun. PreOpenType — Select at what moment the tunnel curtain starts being controlled by the static pressure level: right after the pre-opening delay (Normal Pre-Opening), or at the startup of the second tunnel stage (Tunnel Help mode). In tunnel help mode, the curtain opens during the pre-opening delay then remains in position; it starts being controlled by the static pressure when the following stage starts. **This parameter is available if the tunnel curtain’s operation is based on the static pressure and if the curtain is not used in natural ventilation (see below).* —

Tunnel Pre open Time — This delay is used to open the curtain before activating the fans when the controller enters in tunnel ventilation. This parameter ranges from 0 to 60 seconds. **This parameter is available if the tunnel curtain’s operation is based on the static pressure and if the curtain is not used in natural ventilation (see below).*

Mult. Tun. Stg w/age — (Multiple Tunnel Stages with age) This parameter limits the use of tunnel stages according to the animal age. It allows specifying the maximum tunnel stage that can be performed at three different ages. **This parameter is available if the tunnel curtain and animal age functions are enabled.*

Use Tunnel in Natural? — Select “Yes” to keep using the tunnel curtain while the controller is in natural ventilation (sec. 6.6.2)

Use Stir Fans? — Set to “Yes” to use stir fan relays on stage 1 (sec. 4.7.3).

Use Variable? — Select “Yes” to enable 2 variable outputs.

Var. 1-2 Minimum Speed — Set the absolute minimum speed of both variable outputs.

Use Ramping on Stage 1? — This function allows to smooth out the transition from the minimum ventilation cycles to the full operation of stage 1. Select “Yes” to enable this option. **This parameter is available if variable outputs are disabled. Refer to section 6.1.3.1 for further information.*

Use Ramp. Below SetP — With this function, the controller automatically adjusts the run time of stage 1 fans in minimum ventilation according to the outside temperature: as the weather gets colder, the fan run time decreases gradually to compensate for the change. Refer to section 6.1.3.2 for further information.

Stage 1 Ramp Delay (Advanced) — This delay is used when the outside temperature is greater than the outside set point (or if no outside temperature sensor is used). If the difference between the current On Time of stage 1 and the On Time calculated by the ramping algorithm is greater than this delay, the On Time becomes the new calculated value (sec. 6.1.3). **This parameter is available from the factory mode and if variable outputs are disabled.*

Stage 2 Ramp Delay (Advanced) — This delay is used when the outside temperature is lower than the outside set point. If the difference between stage 1’s current On Time and the calculated On Time value is greater than this delay, the On Time becomes the new calculated value (sec. 6.1.3). **This parameter is available from the factory mode, if the ramping on stage 1 function is enabled above, and if the outside temperature probe is enabled below.*

Outside T° Set Point (Advanced) — The controller uses this value to calculate the ramping delay (sec. 6.1.3). **This parameter is available from the factory mode (dealer), if the ramping function on stage 1 is enabled, and if the outside temperature sensor is enabled below.*

Installation	
Use Tunnel ?	Yes
Tunnel Mode	Timed/SP
Vent Door Transition	Open/SP/As is
Tun. PreOpenType	TunnelHelp /Normal
Tunnel Pre open Time	15 sec
Mult. Tun. Stg w/age	Yes
Use Tunnel In Natural?	Yes
Use Stir Fans?	Yes
Use Variable?	Yes
Var. 1 Minimum Speed	10 %
Var. 2 Minimum Speed	10 %
Use Ramping on Stage 1?	Yes
Use Ramp. Below SetP	Yes
Stage 1 Ramp Delay	10 sec
Stage 2 Ramp Delay	10 sec
Outside T° Set Point	50.0 °F
Ramping Cycle	5 sec
Use Outside Temperature?	Yes
Use Relative Humidity?	Yes
Use Static Pressure?	Yes
SP Vent Set 2	None/Stage/T°Out
Pre-Open Mode	Auto/Man
Pre-Open Vent Doors	10 sec
Pre-Open Attic	10 sec
SP Tunnel Set 2?	None/Stage
Exit: Press Back Change: Press +/-	
Press ▲▼ to select an item	

Ramping Cycle (Advanced) — Frequency at which the ramping cycle is calculated (sec. 6.1.3). **This parameter is available from the factory mode (dealer), and if the ramping function on stage 1 is enabled above.*

Use Outside Temperature? — Select “Yes” if an outside temperature probe is connected to the controller.

Use Relative Humidity?: — Select “Yes” if a humidity sensor is connected to the controller.

Use Static Pressure? — Select “Yes” if a static pressure (SP) sensor is connected to the controller.

SP Vent Set 2 — Select at what moment the second set of pressure set points start being used for the operation of vent doors: Select “Stage” to start using the second group of set points at the startup of a specific fan stage; select “Out T°” to start using it as the outside temperature decreases; select “None” to disable this function. Refer to section 6.4.2 for further information. **This parameter is available if the tunnel curtain operates according to the static pressure.*

Installation	
SP Tunnel Set 2?	None/Stage
Use SP Comp. on Inlets?	Yes
Send temp. Comp. each	2:00(m:s)
Use Curve on Low SP Alarm?	Yes
Monitor Breaker Temp.?	Yes
Vent Door Mode	SP/Time/Ext
Use 2nd Inlet?	Attic/2nd inlet/None
Attic mode	Timed/SP
2nd Inlet type	Sidewall/Tunnel
2nd Inlet mode	Timed/SP
Attic/2nd Inlet Probe	Room/Indiv
Shown on LED Display	
Static Pressure?	Yes
Vent Door Position?	Yes
Exit: Press Back	Change: Press +/-
Press ▲▼ to select an item	

Pre-Open Mode — In minimum ventilation, the controller slightly opens the vent doors before activating the fans. Select “Auto” to use an automatic pre-opening delay or select “Man” to set this delay. **This function only applies to the vent door outputs; it does not apply to the attic vent.*

Pre-Open Vent Doors — The pre-opening of vent doors can be adjusted from 0 to 60 seconds. **This parameter is available if the pre-opening mode is set to “Man” above.*

Pre-Open Attic — The pre-opening of the attic vent ranges from 0 to 60 seconds. **This parameter is available if the second inlet is used as an attic vent (see below).*

SP Tunnel Set 2? — Select “Stage” if the tunnel curtain starts using a second group of static pressure set points at the start-up of a specific ventilation stage; select “None” if the tunnel curtain does not use a 2nd group of pressure settings. **This parameter is available if the tunnel operates according to the static pressure. Refer to section 6.3.1 for further information.*

Use SP Comp. on Inlets? — Select “Yes” for the controller to adjust the opening of the air inlets when the static pressure level gets out of range. **This parameter is available if an air inlet and the static pressure sensor are enabled above. To enable an air inlet, set the “Vent Door Mode” to “Ext” below and then enable the proper number of inlets above.*

Send Temperature Compensation each — If a temperature compensation has to be applied on the position of the air inlets, the controller only sends a compensation request of 1% at a time. Specify the frequency at which a 1% compensation must be applied on the position of the inlets. This parameter prevents moving the air inlets too much in a short period of

time (refer to section 6.4.1 for further information on this compensation). **This parameter is accessible if an air inlet is enabled above (“Vent Door Mode” is set to “Ext” below and number of inlets is greater than 1 above).*

Use Curve on Low Static Pressure (SP) Alarms? — The controller can automatically change the low static pressure alarm limit with time. With the low SP alarm curve, you can program 3 different low pressure alarm limits and the moment at which each limit starts being used is defined as a function of the animal age. Select “Yes” to enable the low SP alarm curve or select “No” to disable this curve.

Monitor Breaker Temp.? — Select “Yes” to monitor the temperature of the main breaker. When this function is enabled, the controller sounds an alarm if the temperature of the sensor located near the breaker gets too high.

 **Install the breaker’s probe close to the breaker box, not inside the box!**

Vent Door Mode — Select the proper operating mode of the first air inlet output.

SP: Select “SP” if the first inlet output is used to control pressure-based vent doors.

Time: Select “Time” if the first inlet output is used to control timer-based vent doors that are using the built-in timer of the controller. **DO NOT** select this option if the vents are using the timer of an external SB3500 module: in this particular case, select the “Ext” option to enable the external module.

Ext: Select “Ext” if the first inlet output is used to connect external air inlet modules such as SB3000 potentiometer feedback modules or SB3500 timer-based inlet modules. **Up to 10 SB modules can be connected to the first inlet output. Go back to the top of the installation menu so set the number of modules properly (“Number of Inlets” parameter).*

Use 2nd Inlet? — In order to enable the second inlet output, select the particular function of this output: it can either be used to control an attic vent (select “Attic”), or it can be used as a supplementary tunnel curtain or vent door output (in both cases, select “2nd Inlet”).

Attic Mode — Specify the operating mode of the attic vent: select “SP” if it moves according to the level of static pressure or select “Time” if it moves according to a timer. **This parameter is accessible if the second inlet output is used to control an attic vent and if the static pressure sensor is enabled above.*

2nd Inlet Type — If the second inlet does not control an attic vent, select its particular function: tunnel curtain or sidewall (sidewall = vent door). **This parameter is accessible if the second inlet output does not control an attic vent.*

2nd Inlet Mode — Specify the operating mode of the second inlet: select “SP” if it moves according to the level of static pressure or select “Time” if it moves according to a timer. **This parameter is accessible if the second inlet output does not control an attic vent and if the static pressure sensor is enabled above.*

Attic/2nd Inlet Probe — The controller allows you to specify the temperature probe that is used by the second air inlet output. Select “Room” if the output refers to the room temperature or select “Indiv” to specify a particular probe in the “Probe Assignment” menu. **Note that this parameter is displayed for consultation purpose only. It has no effect on the way the 2nd inlet operates.*

Shown on LED Display — The red LED display is used to show the room temperature. You can also choose to display the room temperature along with the static pressure level and/or the vent door position. **Note that the static pressure level can only be shown if the SP sensor is enabled above and the vent door position can only be shown when using timer-based vent doors.*

4.6. Probe Settings

4.6.1. Probe Assignment

Principle of Operation: This section explain how to select temperature probes that are used to measure the room temperature and how to assign temperature probes that are used to control/ monitor the outputs of the controller.

 **Worksheets are available at the end of this manual to write down your selection of sensors.**

1. Select:
 - » 22. Relay and Probe Assignment*
2. Select the desired probe assignment menu:
 - » 12. Probes for Stages
 - » 13. Probes for Heaters
 - » 14. Probes for Coolings
 - » 15. Probes for Naturals
 - » 16. Probes for Inlets
 - » 17. Probes for 0-10V Outputs
 - » 18. Probes for Main Breaker
 - » 19. Probes for Vent Door 1
 - » 20. Probes for Attic/2nd Inlet**

*This menu is only accessible from the installer mode (sec. 4.2).

** This menu is accessible if the "Attic / Ven Doors Probes" parameter is set to "Indiv." in the installation menu (sec. 4.5).

Cooling Probe Assignment							
Show Probes of : Cooling 3							
1	2	3	4				
---	---	---	---				

3. Depending on the chosen output, assign the temperature probes as follows:

Probes for Stages (or Room Temperature) — All fan stages operate according to the average temperature in the room. Select what probes are used to measure the average room temperature. *Make this probe assignment separately for each program in use (if applicable).

Probes for Heaters — Each heating output operates according to the average temperature reading of a chosen temperature probe set. Select what probes are used to control each one of them (regular & Hi Fire heating stages). *Make this probe assignment separately for each program in use (if applicable)

Probes for Cooling Outputs — Each cooling output operates according to the average temperature of a chosen temperature probe set. Select what probes are used to control each one of them. Note that the outside temperature probe (probe 0) can also be part of the average temperature. That is to make sure the outside temperature is sufficient to permit the activation of the cooling output. *This parameter is available if cooling outputs are enabled in the installation setup (sec. 4.5).

Probes for Naturals — Specify which temperature probes are located in each natural ventilation zone. When the controller operates in natural ventilation, the natural curtain will move as a function of the ambient temperature of its respective zone. Note that the outside temperature probe (probe 0) can also be part of the average temperature of a zone. That is to make sure the outside temperature is sufficient to permit the opening of the natural curtain.

Probes for Natural — Assign temperature probes to each natural zone (probe 0 refers to the outside temperature probe). *This parameter is available if natural zones are enabled in the installation setup (sec. 4.5).

Probes for Inlets — Each inlet that is connected to a SB module operates according to the average reading of chosen temperature probes. Select what probes are used to control each one of them. *This parameter is available if inlets are enabled in the installation setup (sec. 4.5).

0-10V Outputs — Each 0-10V output that is used for cooling or heating operates according to the average temperature reading of a chosen temperature probe set. Select what probes are used to control each one of them.

Main Breaker Probes — A probe can be used to monitor the temperature of the main breaker so that the controller can sound an alarm if the breaker's temperature gets too high. Select which probe is used for this purpose.

Probes for Attic/2nd Inlet — If the second air inlet output uses particular temperature probes, please select them in this table. *Note that this selection of probe is made for consultation purpose only. It has no effect on the way the 2nd inlet operates.

Probes for Vent Door 1 — If the first vent door output uses particular temperature probes, please select them in this table. *Note that this selection of probe is made for consultation purpose only. It has no effect on the way the vent door operates.

4.6.2. Probe & Water Meter Calibration

You can slightly adjust the reading of each probe input in order to obtain accurate and uniform readings from all probes. In addition, if a water meter is used, you must calibrate its water flow rate.

1. Select:
 - » 23. Controller Setup
 - » 3. Probe Calibration*

* This menu is only accessible from the installer mode (sec. 4.2).

Probe Calibrations	
Inside Temp. Probe 1	0.0 °F
Inside Temp. Probe 2	0.0 °F
Inside Temp. Probe 3	0.0 °F
Outside Temperature	0.0 °F
Relative Humidity	0 %
Static Pressure	.000 "WC
Water Meter 1	1 gal/p
Water Meter 2	1 gal/p

2. Adjust the reading of the probes (if required).

Inside Temperature Probe — The reading of the inside and outside temperature sensors can adjusted of $\pm 5^{\circ}\text{F}$ ($\pm 2.3^{\circ}\text{C}$).

Relative Humidity Probe — The reading of the humidity sensor can adjusted of $\pm 3\%$.

Static Pressure (SP) Probe — The reading of the static pressure probe can adjusted of ± 0.030 "WC ($\pm 7\text{Pa}$).

Water Meters — Set the water flow per pulse of each water meter. This parameter ranges from 1 to 100 gallons (or liters) per pulse.

4.7. Relay Assignment

4.7.1. Principle of Operation

RELAY PANELS: External relay panels can be connected to the controller. In all, the controller can monitor up to 100 external On/Off relays and 2 variable outputs.

The following procedure shows how to link up the relays with the various stages and outputs. Refer to the wiring diagram enclosed with this manual to connect the relay panels to the controller and to wire the loads. Note that the relay assignment can only be done from the installer mode

 **Worksheets are available the end of this manual to write down your relay assignment settings.**

 **Use the arrow keys to navigate through the relay assignment window.**

4.7.2. Heaters' Relay Assignment

Assign relays to all heating outputs and to all hi fire heating outputs (if applicable). If heater programs are enabled in section 4.5, make the relay assignment separately for each program in use.

1. Select:

- » 22. Relay and Probe Assignment*
- » 2. Relays for Heaters**

* This menu is only accessible from the installer mode (sec. 4.2).

** This menu is accessible if heaters are enabled (sec. 4.5).

Heater Relay Assignment							
1	2	3	4	5	6	7	8
---	---	---	---	---	---	---	---
9	10	11	12	13	14	15	16
---	---	---	---	---	---	---	---
17	18	19	20	21	22	23	24
---	---	---	---	---	---	---	---

2. Select the proper heating output amongst the ones that have previously been enabled (sec. 4.5).

3. Put a check mark to assign a relay.

4.7.3. Fan Stage Relay Assignment

This section shows how to assign relays to fan stages, how to use variable outputs, and how to enable stir fans and timer-based relays in the stages.

4.7.3.1. Ventilation Relays : Principle of Operation

TIMER-BASED RELAYS ON FAN STAGES
Timer-based relays run according to a timer as long as their associated fan stage is on. They are useful to run devices that need to follow the same progression as fan stages in timer mode. Section 4.7.3.1 shows how to activate timer-based relays and section 4.7.3.2 shows how to set the timer.

STIR FAN RELAYS ON FAN STAGE 1:

Stir fan relays of stage 1 run continuously in minimum ventilation and during stage 1. Using this type of relay allows activating stir fan outputs without interruption while minimum ventilation cycles are performed.

VARIABLE OUTPUTS:

Each fan stage can use two variable fan outputs. Specify the operating mode of the variable outputs for each fan stages as follows:

Var.: When the fan stage starts, the variable outputs starts at its minimum intensity then gradually increases in speed as the fan stage progresses.

ON: The variable output acts as an ON/OFF output: it is activated at its full capacity when its associated fan stage is on.

OFF: The variable output is not activated.

4.7.3.2. Fan Stage Relay Settings

Select the relays associated with each fan stage:

1. Select

- » 22. Relay and Probe Assignment*
- » 1. Relays for Stages **

* This menu is only accessible from the installer mode (sec. 4.2).

** Refer to the previous section to get further information about these parameters.

Stage Relay Assignment								
Show Relay of				:	Stage 1			
1	2	3	4	5	6	7	8	
---	---	---	---	---	---	---	---	
9	10	11	12	13	14	15	16	
---	---	---	---	---	---	---	---	
17	18	19	20	21	22	23	24	
---	---	---	---	---	---	---	---	

2. Select a fan stage.

3. Make the relay assignment for the selected stage: put a check mark to assign an On/Off relay, select "TMR" to assign a timer-based relay, "STR" to assign a stir fan relay.

 **YOU MUST ASSIGN RELAY(S) TO ALL FAN STAGES IN USE! An alarm sets off when a fan stage that does not activate any relay is activated (this is true except for natural ventilation stages and for variable stages 1 and 2). When this type of alarm occurs, the controller keeps using the relays of the previous fan stage.**

Timer-based relays are used to activate misting units. If cooling units are programmed to stop when the humidity level gets too high, timer-based relays will also stop running (except if the controller is in minimum ventilation. Refer to section 10.2 for further information about the mist shutoff option.

 **The relay assignment for fan stages 1 to 6 must be done separately for each program in use. Press "A" to select a program.**

4.7.3.3. Variable Outputs & Timer Settings

The following procedure shows how to enable variable outputs within fan stages. It also demonstrates how to adjust the On and Off times of fan stages' timer-based relays.

1. Select:

- » 22. Relay and Probe Assignment*
- » 10. Relay Timer/Variable Settings**

* This menu is only accessible from the installer mode (sec. 4.2).

** See sec. 4.7.3.1 for further information.

Relay Timer and Variable Settings	
Show Settings of Stage	1
Variable 1	Off
Variable 2	Off
Relay Timer Mode	Sec
Relay On Time	15 sec
Relay Off Time	0 sec

2. Select a fan stage.

Variable 1-2 — Set the status of both variable outputs during the selected fan stage (On, Var. or Off). *This parameter is available if variable outputs are enabled (sec. 4.5).

Relay Timer Mode — Select whether the relays' timer is set in seconds (0 to 900 seconds) or in hours (0 to 9:00 hh:mm).

Relays' On Time — This is the run time of timer-based relays for the selected fan stage. This parameter ranges from 0 to 900 seconds (or 0 to 9:00 hh:mm).

Relays' Off Time — This is the idle time of timer-based relays for the selected fan stage. This parameter ranges from 0 to 900 seconds (0 to 9:00 hh:mm).

 **The status of the variable output and the timer of fan stages 1 to 6 must be set separately for each program in use. Press "A" to select a program.**

 **YOU MUST ASSIGN RELAY(S) TO ALL FAN STAGES IN USE! An alarm sets off whenever a fan stage that does not activate any relay is activated. When this situation occurs, the controller keeps using the relays of the previous fan stage.**

4.7.3.4. Copying / Pasting Fan Stage Relays

It is possible to duplicate the relay selection of a fan stage onto another stage by using the copy and paste function. This avoids repeating the same programming sequence several times.

1. Select:

- » 22. Relay and Probe Assignment*
- » 21. Copy Paste

* This menu is only accessible from the installer mode (sec. 4.2).

Relay Timer and Variable Settings	
Select item to copy:	Stg Relay
Copy from:	Stage 1
Paste to:	Stage 2
Confirm?	No

2. Set the following parameters:

Select item to copy — Select the "Stg Relay" option.

Copy From — This is the source fan stage. The one that will be duplicated.

Paste to — This is the target fan stage. The one on which the copied relays will be pasted.

3. Once the source and the target stages have both been defined, the message "Confirm?" appears on the display. Select "Yes" to confirm the stage relays' duplication. The message "Copy in progress... please wait.." is displayed. Wait until the duplication process is over.

4.7.4. Curtain, Vent Door & Attic Relays

Assign an opening and a closing relay to each output that uses an actuator (natural ventilation curtain, vent doors, 2nd air inlet output & tunnel curtain). Connect these outputs to the relays that have been designed for this purpose on the relay panels (Open/Off/Close relay).

1. Select:

- » 22. Relay and Probe Assignment*

2. Select the relay assignment menu **:

- » 3. Tunnel Curtain
- » 4. Vent Door
- » 5. Attic/2nd Inlet (for the 2nd tunnel curtain, 2nd sidewall vent or for the attic vent)
- » 9. Natural

* This menu is only accessible from the installer mode (s.4.2).

** Only the outputs that are enabled in the installation menu are available (sec. 4.5).

Tunnel Door Relay Assignment								
Show Relays of				:	Open Door			
1	2	3	4	5	6	7	8	
---	---	---	---	---	---	---	---	
9	10	11	12	13	14	15	16	
---	---	---	---	---	---	---	---	
17	18	19	20	21	22	23	24	
---	---	---	---	---	---	---	---	

3. Select the output's opening relay and then put a check mark to assign the opening relay.

4. Select the output's closing relay and then put a check mark to assign the closing relay.

4.7.5. Clock Output Relays

The following procedure shows how to assign clock outputs relays. It also explains the principle of operation of the common relays.

Common Relays: It is possible to match the activation of some outputs with the activation of clock outputs; i.e. all outputs that share a common relay must be activated simultaneously for the relay to switch. This function may be used to deactivate an output during night or on specific days of the week for instance. Devices that share common relays with clock outputs are thus stopped when the clock output is off. This is true for all type of outputs except for fan stages and cooling outputs: these outputs' relays are not affected by common relays.

Example of how to deactivate an output during night:

1. Heater 4 uses relay 6;
2. Relay 6 is also used by clock output 1 and is a common relay.
3. Clock output 1 is disabled during night.

Result : Heater 4 operates normally as long as clock output 1 is active but cannot be enabled during night while the clock output is off.

4.7.5.1. Clock Output Relays

Select the relays that are associated with each clock output.

1. Select:
 - » **22. Relay and Probe Assignment***
 - » **6. Relays for Clocks****
 - » **1. Relay Assignment**

** This menu is only accessible from the installer mode (sec. 4.2).*

*** Available if clock outputs are enabled (sec. 4.5).*

Clock Relay Assignment							
Show Relays of							Clock 1
1	2	3	4	5	6	7	8
---	---	---	---	---	---	---	---
9	10	11	12	13	14	15	16
---	---	---	---	---	---	---	---
17	18	19	20	21	22	23	24
---	---	---	---	---	---	---	---

2. Select a clock output.
3. Put a check mark to assign a relay.

4.7.5.2. Selecting Common Relays

When a common relay is assigned to a clock output and to any other output, all outputs that use that same relay must be activated simultaneously for the relay to switch (except for fan stage and cooling output relays).

1. Select:
 - » **22. Relay and Probe Assignment***
 - » **6. Relays for Clocks****
 - » **2. Common Relays**

** This menu is only accessible from the installer mode (s.4.2).*

*** Available if clock outputs are enabled (sec. 4.5).*

Common Relay							
1	2	3	4	5	6	7	8
---	---	---	---	---	---	---	---
9	10	11	12	13	14	15	16
---	---	---	---	---	---	---	---
17	18	19	20	21	22	23	24
---	---	---	---	---	---	---	---

2. Put a check mark to identify a common relay.

4.7.6. Cooling Output Relays

Select the relays that are associated with each activated cooling output as follows:

1. Select:
 - » **22. Relay and Probe Assignment***
 - » **7. Relays for Cooling****

** This menu is only accessible from the installer mode (sec. 4.2).*

*** This menu is accessible if cooling outputs are enabled (sec. 4.5).*

2. Select a cooling output.
3. Put a check mark to assign a relay.

4.7.7. Backup Box Relay

Select the backup box relay. This normally closed relay opens when a controller or power failure occurs.

1. Select:
 - » **22. Relay and Probe Assignment***
 - » **8. Relays for Backup**

** This menu is only accessible from the installer mode (sec. 4.2).*

2. Put a check mark to assign a relay.

4.7.8. Feeder Relay

Feeder relays are normally closed contact. This contact opens when a feeder run time alarm occurs, causing the stop of the feeder's motor.

1. Select:
 - » **22. Relay and Probe Assignment***
 - » **11. Relays for Feeder**

** This menu is only accessible from the installer mode (sec. 4.2).*

2. Put a check mark to assign a relay.

4.8. Test Mode

The test mode is used to simulate temperature and static pressure changes to verify the controller's performance. The temperature probe and static pressure inputs are turned off while the test mode is on. This mode is automatically deactivated after 15 minutes of inactivity or when you disable it.

1. Select:

- » 23. Controller Setup
- » 9. Test Mode

Test Mode	
Test Mode Status	Off
Temperature	77.9 °F
Static Pressure	.080 "WC

2. Set the following parameters:

Test Mode Status — Select "Yes" to enable the test mode, select "No" to exit from the test mode.

Temperature — Enter the simulated room temperature. **This parameter can only be changed if the test mode status is enabled above.*

Static Pressure — This is the current static pressure level in the room. This value is shown as a reference only; it cannot be modified. **This parameter is only shown if the static pressure sensor is enabled (sec. 4.5).*

4.9. Version

This menu shows your controller's version number. This piece of information is useful to get technical support.

1. Select:

- » 23. Controller Setup
- » 10. Version

CC24-7 Elite	
SETTINGS	V X.X
Core	V X.Xx
Date	

5. TEMPERATURE SETTINGS

5.1. Temperature Set Point

The set point is a target temperature; the activation and deactivation of the various stages is based on this reference temperature.

NIGHT SET POINT: A night set point can be enabled to lower the target room temperature during night. This set point is relative to the regular temperature set point, which means that if the regular set point changes with time, the night set point is adjusted accordingly. To use a night set point, enable the night set point function in the installation in section 4.5 and set the time at which the night begins in section 4.1.1.

SET POINT CURVES: Use a temperature curve to get an automatic adjustment of the set points over a given period of time. The target temperature is thus always adapted to the animals' needs as they grow. Refer to section 5.1.2 for further information about the curves.

5.1.1. Set Point Settings

1. Select:

» 7. Temperature Set Point—or press “B”.

 **The set points can only be modified while the curve is off.**

Temperature Set Point	
Curve Status	Off
Temperature Set Point	80.0 °F
Night Temp. Set Point	80.0 °F

2. Set the following parameters:

Curve Status — Shows the current status of the set point curve. This piece of information cannot be modified. Refer to section 5.1.2 to modify the curve status. **This parameter is available if the set point curve option is enabled (sec. 4.5).*

Temperature Set Point — This parameter ranges from -40°F to 100 °F (-40.0°C to 37.8°C). **Can only be modified when the curve status is Off (sec. 5.1.2).*

Night Set Point — This parameter ranges from -40°F to 100 °F (-40.0°C to 37.8°C). **This parameter is available if the night set point function is enabled (sec. 4.5).*

 **This value can only be modified while the curve status is Off (sec. 5.1.2).**

5.1.2. Set Point Curve

The set point curve allows an automatic adjustment of the target room temperature over time.

The set point changes using 10 steps. Each step specifies a day number and a target temperature for that day. These steps are based on the animal age. Once all steps are defined, the curve must be activated. The controller then starts changing the temperature set point every hour in a linear fashion between consecutive steps of the curve. When the last step is reached, the temperature set point for that day is maintained until a new animal batch starts and until the animal age is reset.

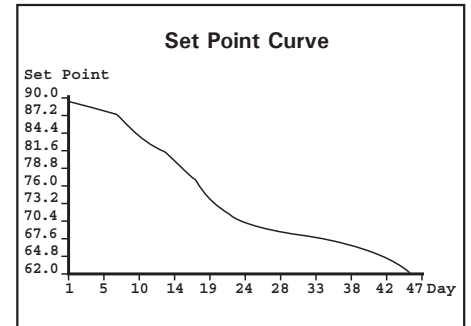

Night set point: If a night set point is used, the set point curve stops being used during night.

NOTE: Certain restrictions apply to reduce the risk of errors:

- The highest possible day number is 450.
- Decreasing day numbers is not allowed.
- All ten steps must be specified. If you don't need ten different steps, repeat the last temperature for each unnecessary step.

1. Select:

- » 9. Curve Settings*
- » 1. Temperature Set Point

*This menu is accessible if the set point curve option is enabled in section 4.5.

Temperature Set Point Curve	
Set Point	70.0°F
day 1	78.0°F
day 3	75.0°F
day 5	70.0°F
day 10	65.0°F
day 15	63.0°F
day 20	61.0°F
day 25	60.0°F
day 30	60.0°F
day 35	60.0°F
day 40	60.0°F
Curve Status:	Off

Exit: Press Back Change: Press +/-
Press ▲▼ to select an item

2. Set the following parameters:

 **The curve steps can only be modified while the curve is disabled.**

Day Number — Set the day for each of the 10 steps. This number corresponds to the animal age and is adjustable from -5 to 450 days. Negative values are used to prepare the house before the letting the animals enter the building. *Can only be modified while the curve is disabled.

Temperature — Set the temperature associated with each step of the curve. *Can only be modified while the curve is disabled.

Curve Status — Select “Yes” to activate the curve. Once it is enabled, the set point automatically becomes adjusted between consecutive points of the curve; for this reason, the set point and curve steps cannot be modified while the curve is on.

6. VENTILATION & COOLING

6.1. Minimum Ventilation

6.1.1. Minimum Ventilation Cycles

6.1.1.1. Principle of Operation

Minimum ventilation cycles are used below fan stage 1. Running the fans even though ventilation is not required for reducing the room temperature is useful to reduce the humidity level and supply oxygen to the room. It also prevents the fans from freezing in winter.

If variable fan outputs are enabled, the controller activates these fans at a user-defined speed during the minimum ventilation cycles; if they are not used, the controller then uses stage 1 fans.

Minimum Ventilation Timer: The minimum ventilation timer is composed of an “On Time” and of a “Cycle Time”. The fans run during the “On Time” and then stop until the end of the “Cycle Time”.

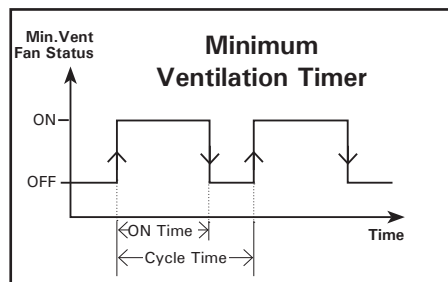

Stir Fans In Minimum Ventilation: Stir fan relays of stage 1 run continuously during the minimum ventilation cycles and on stage 1. This allows bypassing the minimum ventilation’s timer. Refer to section 4.7.3.2 to use this feature.

6.1.1.2. Settings

WITH VARIABLE OUTPUTS:

1. Select:

- » 8. Minimum Ventilation – or press “C”

Test Mode	
Variable 1	Curve Off
Status	On
On Time	15 sec
Off Time	15 sec
Minimum Speed	30 %
Variable 2	Curve Off
Status	On
On Time	15 sec
Off Time	15 sec
Minimum Speed	30 %

2. Set the following parameters:

Curve Status — The minimum ventilation curve status is displayed but cannot be modified. Refer to section 6.1.2 to modify it.

On / Off Times — Set the minimum ventilation timer’s On and Off times of both variable outputs. This parameter ranges from 0 to 900 seconds.

Minimum Speeds — Set the speed of both variable outputs that is used in minimum ventilation. *Can only be modified if the curve is disabled (sec. 6.1.2).

WITHOUT VARIABLE OUTPUTS:

1. Select:

- » 8. Minimum Ventilation – or press “C”

Minimum Ventilation	
Minimum Ventilation Curve	Off
Minimum Vent. On Time	30 sec
Minimum Vent. Cycle Time	60 sec
Calculated On Time	30 sec

2. Set the following parameters:

On / Cycle Times — Set the On & Cycle times of the minimum ventilation timer. These parameters range from 0 to 900 seconds. *The cycle time is limited by the pre-opening delay of the air intake that is used in minimum ventilation (attic vent or vent door); it must be greater than twice pre-opening delay + 10 seconds (s.4.5). In addition, the cycle time must be greater than the On Time. Finally, note that these parameters can only be modified if the curve is disabled (sec. 5.1.2).

Calculated On Time — If the minimum ventilation curve is enabled, the fans’ on time in minimum ventilation is automatically adjusted over time. The calculated On Time is the current On Time, as defined by the curve. *This value cannot be modified.

6.1.2. Minimum Ventilation Curve

6.1.2.1. Principle of Operation

• **If Variable Outputs are used:** If variable-speed fans are used in minimum ventilation, the controller can automatically increase the minimum ventilation speed over time with a curve. The speed curve must be defined separately for each variable-speed fan.

• **Without Variable Outputs:** If On/Off fans are used in minimum ventilation, the controller can automatically increase the "On Time" portion of the minimum ventilation cycle with time.

Curve definition: A curve is composed of 10 steps. Each step specifies a day number and a minimum ventilation speed (or "On Time") for that day (the day number refers to the animal age). When the curve is activated, the controller changes the minimum ventilation speed (or "On Time") every hour in a linear fashion between consecutive steps of the curve. When the last step is reached, the controller keeps using the speed (or "On Time") associated to that day.

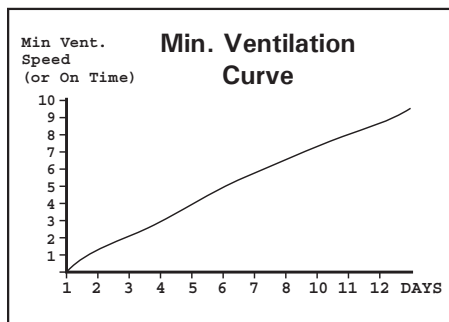

Notes: Certain restrictions apply to reduce the risk of errors:

1. The highest possible day number is 450.
2. Decreasing day numbers is not allowed.
3. All ten steps must be specified. If you don't need 10 different steps, repeat the last speed (or "On Time") for each unnecessary step.

6.1.2.2. Min Vent. Curve Settings

• WITH VARIABLE OUTPUTS:

1. Select:
 - » 9. Curve Settings
 - » 2. or 3. Variable 1 or 2*

* This menu is accessible if the minimum ventilation curve and variable outputs are enabled (sec. 4.5).

*Only the variable outputs that are used in minimum ventilation are available (sec. 6.1.1.2).

Minimum Ventilation Variable 1 Curve	
Speed	30 %
day 1	10 %
day 10	12 %
day 15	14 %
day 20	16 %
day 25	18 %
day 30	20 %
day 35	25 %
day 40	30 %
day 45	35 %
day 50	40 %
Curve Status	Off

Exit: Press Back Change: Press +/-
Press ▲▼ to select an item

2. Set the following parameters:

The curve steps can only be modified while the curve is disabled.

Day Number — Set the day for each of the 10 steps. This day number corresponds to the animal age, and is adjustable from -5 to 450 days. Negative values are used to prepare the house before the animals' arrival. *Can only be modified while the curve is disabled.

Speed — Set the fan speed associated with each step of the curve. *Can only be modified while the curve is disabled.

Curve Status — Select "Yes" to activate the minimum ventilation speed curve. Once it is enabled, the minimum ventilation fan speed is automatically adjusted between consecutive steps of the curve; for this reason, these steps cannot be modified while the curve is on.

• WITHOUT VARIABLE OUTPUTS:

1. Select:
 - » 9. Curve Settings
 - » 2. Minimum Vent. On Time Curve

* This menu is accessible if variable outputs are disabled (sec. 4.5).

2. Set the following parameters:

The curve steps can only be modified while the curve is disabled.

Day Number — Set the day for each of the 10 steps. This day number corresponds to the animal age, and is adjustable from -5 to 450 days. Negative values are used to prepare the house before the animals' arrival. *Can only be modified while the curve is disabled.

On Time — Set the On Time of the minimum ventilation cycles for each step of the curve. *Can only be modified while the curve is disabled.

Curve Status — Select "Yes" to activate the minimum ventilation curve. Once it is enabled, the running time of the fans, during the minimum ventilation, is automatically adjusted between consecutive steps of the curve; for this reason, these steps cannot be modified while the curve is on.

6.1.3. Min Vent. Ramp & Compensation

6.1.3.1. Stage 1 On Time Ramp

The controller has a ramping function to smooth out the transition from minimum ventilation to the full operation of the stage 1 fans; the fans' running time can be automatically adjusted to achieve a gradual increase or decrease in the ventilation level. This function is used when stage 1 does not use variable fans.

When the room temperature is at or below the set point, the fans of stage 1 operate according to the minimum ventilation cycles. When the room temperature increases above the set point, a new On Time is calculated periodically as the temperature increases to allow a smooth progression (from point A to point B) up to full operation of the fans when the start temperature of stage 1 is reached. If the room temperature decreases to stage 1's stop temperature, the ON TIME value of the minimum ventilation cycle decreases gradually from a value equal to the total cycle time (point C) to the value defined by the ramping function.

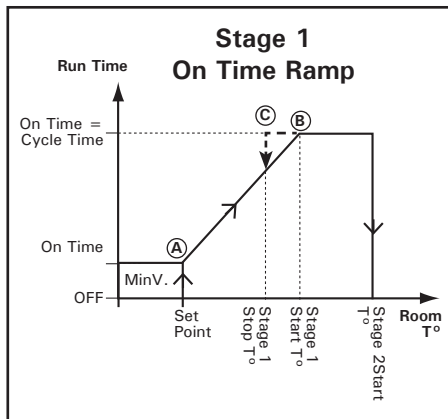

The controller uses two user-defined ramping delays to determine when to adjust the ramping cycle. Ramping delay 1 is used when the outside temperature is greater than the outside set point (it is also used permanently if no outside temperature probe is used); ramping delay 2 is used when the outside temperature is below the outside set point. If the difference between the current on time value and the on time value calculated by the ramping algorithm is greater than the ramping delay, the on time value becomes the calculated value.

6.1.3.2. On Time Compensation Below the Set Point

The controller has the capability of automatically adjusting the running time of the minimum ventilation fans as a function of outside temperature. As the weather gets colder, the on time is decreased gradually to compensate for the change. This can help reduce costs by reducing the ventilation when it is not required. A curve is used to calculate the required compensation as a percentage of current on time (see graph below). Only the running time is adjusted; the total cycle time remains unchanged.

Example: In the first example, compensation is not needed when the outside temperature is greater than 50 °F. The fans operate according to their full running time. In the second example, the running time is decreased to 66.5% to compensate for the colder outdoor temperature. The cycle time remains unchanged.

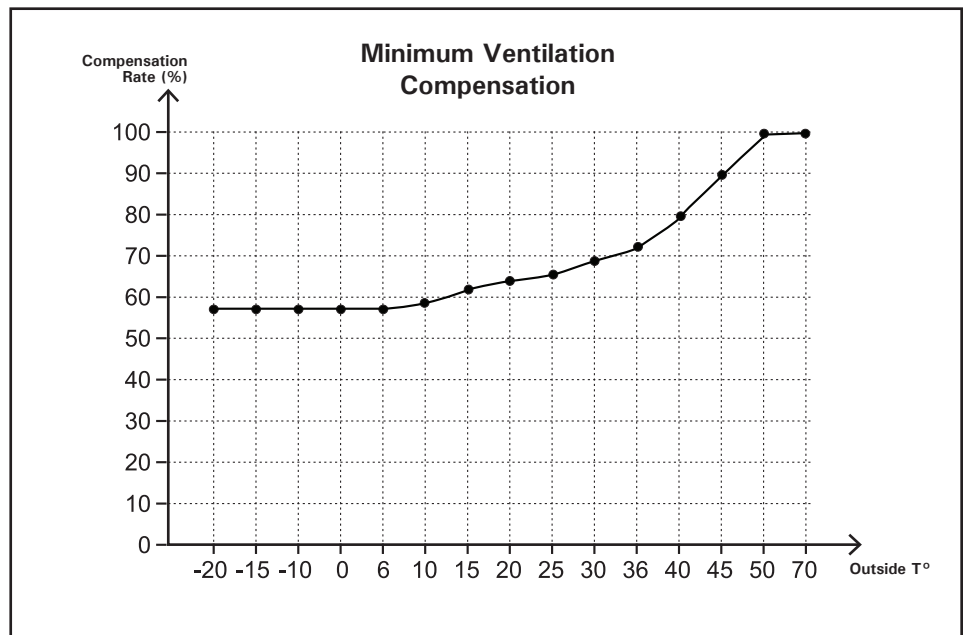
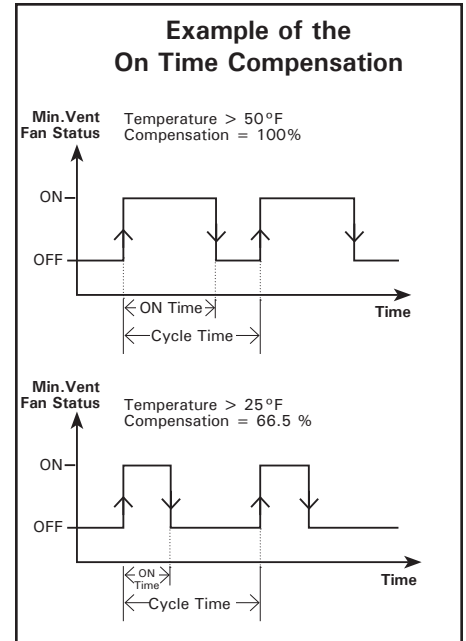

6.2. Fan Stages

6.2.1. Principle of Operation

6.2.1.1. On/Off Fan Stages

The controller has 16 On/Off fan stages which operate in a sequence to increase the level of ventilation as the room temperature increases. Each stage can activate two variable outputs and a combination of timer relays for cooling purposes. A fan stage is activated when the room temperature reaches its start temperature; it is disabled when the room temperature decreases to its stop temperature.

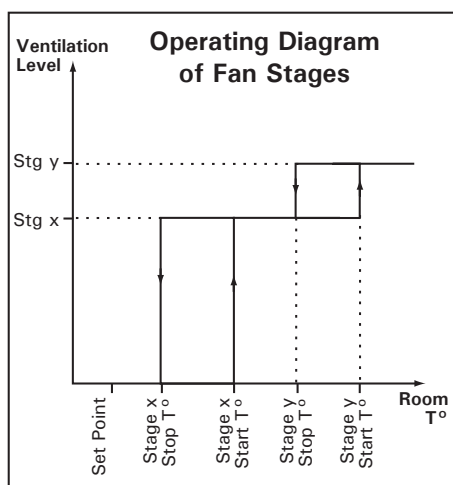

Fan stages' start temperatures are defined with respect to the set point and with respect to each other. This means that when one of these values is adjusted, all the consecutive values are adjusted by the same amount. For example, if the set point is increased by 1°F, the start temperature of all fan stages will be increased by the same amount.

The start and stop temperatures of all fan stages must be set separately for summer and winter. Press "A" to select a season.

Timer Relays for Cooling Devices:

Fan stages can activate relays that will run in timer mode. This option can be used to activate any kind of device that needs to follow the same progression as ventilation stages. The timer is made of an "On Time" and an "Off Time". Refer to section 4.7.3 to activate timer-based relays.

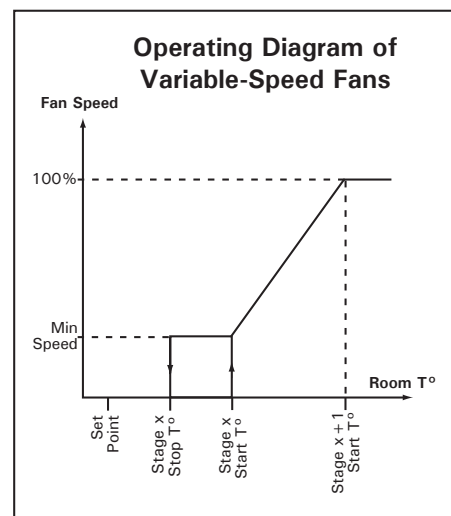
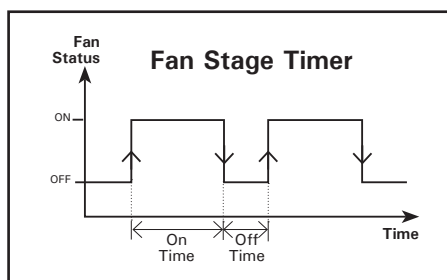

6.2.1.2. Variable Outputs

Variable outputs are activated when their associated fan stage starts (sec. 4.7). They are enabled at their minimum speed, as defined in section 4.4, and gradually increase in speed as the room temperature increases. They reach their full speed when the start temperature of the following fan stage is attained.

Transition between fan stages 1 and 2 :

If the next stage is an ON/OFF fan stage, the variable output is deactivated when the new stage starts. If the next stage is another VARIABLE fan stage, the speed of the first variable fan stage is reduced to minimum when the second variable fan stage starts. This allows a smooth transition between both stages. The graph below sums up the situation:

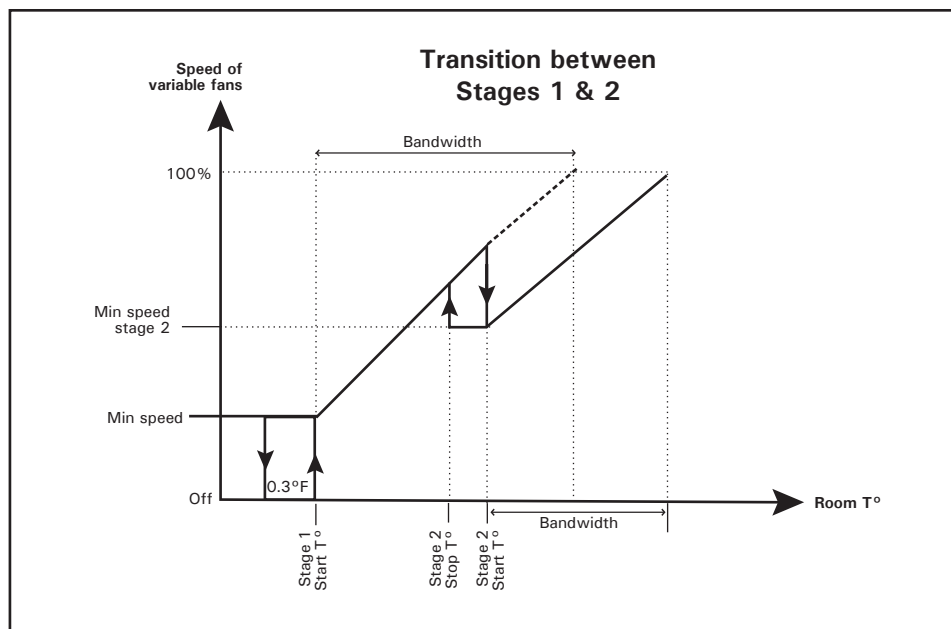

*** Starting Speed:**

The variable outputs used in VAR (variable) in stage 1 or 2 start at the same speed as defined for the minimum ventilation cycles (sec. 6.1.1.2).

The variable outputs used in VAR (variable) within Stage 3 and higher start at their absolute minimum speed (as defined in section 4.5).

The **bandwidth** defines the interval over which the variable output goes from its minimum to its full speed. This is true even if full speed is never reached as in the example above. When the start temperature of stage 2 is reached, the variable output decreases to its minimum speed. V1 bandwidth is then used to increase the fan speed as the temperature increases. When the temperature decreases below stage 2's start temperature, the minimum fan speed is maintained until the stage's stop temperature is reached.

 **The last fan stage must not be configured in variable mode. If the last fan stage uses a variable output, it must be used as an on/off output (sec. 4.7).**

6.2.1.3. 0-10V Ventilation Output

The controller has four 0-10V outputs to control supplementary variable fan stages, lights, or heating devices. The following procedure shows how to use 0-10V outputs for the activation of independent variable fans.

This section explains how 0-10V ventilation outputs work.

At and below the Stop T°:

The output is deactivated.

At the Start T°:

The output operates continuously at its minimum speed, and starts increasing in speed as the temperature increases;

At Start T° + Bandwidth:

The fans reach their maximum speed;

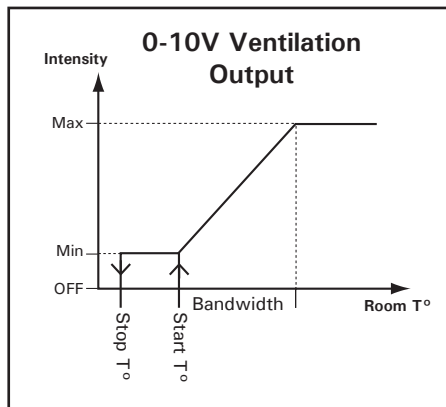

6.2.2. Settings

6.2.2.1. Fan Stage Settings

If seasonal settings are used, set the fan stage parameters separately for both seasons. Press "A" to select a season.

1. Select:

- » 14. Fan/Cool./Nat. Temp. Settings
- » 1. Fan Temperature Settings

Fan Temperature Settings	
Current Temp. Set Point	80.0 °F
Stage 1	
Start Temperature	80.5 °F
Stop Temperature	80.0 °F
V1 Bandwidth	2.0 °F
V2 Bandwidth	2.0 °F
Stage 2	
Start Temperature	80.5 °F
Stop Temperature	80.0 °F
V1 Bandwidth	2.0 °F
V2 Bandwidth	2.0 °F
Stage 3	
Start Temperature	81.0 °F
Stop Temperature	80.5 °F
...	
Stage 16	
Start Temperature	81.0 °F
Stop Temperature	80.5 °F

Exit: Press Back Change: Press +/-
Press ▲▼ to select an item

2. Set the following parameters:

Refer to section 6.2.1 for further information on these parameters.

Current Temp. Set Point — This is the current temperature set point. It is displayed for consultation only and cannot be modified. *Refer to section 5.1 for further information.

Start & Stop Temperatures — Set the start and stop temperatures of each fan stage. The minimum temperature difference between two consecutive start temperatures is of 0.5°F (0.3°C). *These parameters must be set separately for winter & summer.

V1-V2 Bandwidths — Set the number of degrees that is required for variable outputs to reach their full speed (sec. 6.2.1.2). This parameter ranges from 0.5 to 20.0°F (0.3 to 11.1°C). *These parameters must be set separately for winter & summer.. In addition, they are only accessible if variable outputs are enabled (sec. 4.5) and if the variable outputs are using the variable operating mode (sec. 4.7.3.3).

6.2.2.2. 0-10V Output Fan Settings

1. Select:

» 21. 0-10V Output Settings

0-10V Output Settings	
Show Settings of	: Output 2
Output Type	Cooling
Start Temperature	80.0 °F
Stop Temperature	80.0 °F
Bandwidth	3.0 °F
Minimum	15 %
Maximum	100 %
Mode	0-10V

2. Set the following parameters:

Refer to section 6.2.1.3 for further information on these parameters)

Show Settings of — Select the proper 0-10V output. One that will be used for ventilation or cooling purpose. **Note that the first 0-10V output is reserved to control lights if lights have been enabled during the installation.*

Output Type — Select “Cooling” for the output to operate as an independent fan stage. Press Enter to validate the status. The following menus are then displayed:

Start temperature — this is the temperature at which the 0-10V output starts operating continuously at minimum speed. The start temperature can be adjusted of +/- 40°F (22.2°C) from the set point.

Stop Temperature — Temperature at which the 0-10V output is deactivated when the room temperature decreases. It can be adjusted from 0.5°F (0.3°C) below the start temperature to -40°F (22.2°C).

Bandwidth — Temperature interval over which the output goes from its minimum speed to its maximum speed (refer to the previous graph). The bandwidth can be adjusted from 0.5 to 10°F (0.3 to 11.1°C).

Min/Max Speeds — Minimum and maximum speeds of the selected 0-10V output. This parameter ranges from 0 to 100%. The maximum speed must be greater than the minimum speed.

Mode — Select the proper signal used by the selected output : 0-10V or 10-0V.

6.3. Tunnel Curtain

The controller can control up to 2 endwall curtains for tunnel ventilation. These curtains can either be controlled by the static pressure (SP) level or they can move according to a timer. Refer to section 4.5 to select the proper operating principle (Timed/SP).

6.3.1. Static Pressure Curtains

6.3.1.1. Principle of Operation

The controller can control 2 pressure-based tunnel curtains. To enable the first tunnel curtain output, answer "Yes" to the "Use Tunnel" question in the installation menu and set the tunnel mode to "SP". To use the second inlet output as a pressure-based tunnel curtain, enable the 2nd inlet output in the installation menu and set it as being a tunnel curtain that works according to static pressure (refer to section 6.5).

The tunnel curtains start opening when the fan stage that signals the beginning of tunnel ventilation is reached. At that moment, the curtains start being controlled according to the pressure level.

High / Low Pressure Limits: When the static pressure level exceeds the high pressure limit, the curtains open during the "Open Time" and then stay in place during the "Off Time". This process is repeated up until the static pressure level goes back into the acceptable pressure range. The reversed process is performed when the static pressure decreases below the low pressure limit; the curtains close during the "Close Time" and then stay in place during the "Off Time". The "Off Time" is common for both the closing and opening cycles.

Animal Age: It is possible to limit the use of the tunnel ventilation stages according to the age of the animals: you can either specify the minimum age at which tunnel ventilation is allowed, or you can specify the maximum allowable tunnel stage for 3 different ages (refer to section 4.5 to enable/disable the *Multiple Tunnel w/ Age* function).

Static pressure Groups: Two groups of static pressure settings can be defined for the tunnel curtain. These groups allow using different high/low pressure limits as the room temperature changes. The second group of pressure settings starts being used at the start-up of a user-defined fan stage.

Example: When the start temperature of stage 7 is reached, the tunnel curtain starts using the second group of static pressure settings; in other words, new high and low pressure limits start being used. The initial group of parameters are used once again when the room temperature decreases below the stop temperature of stage 7.

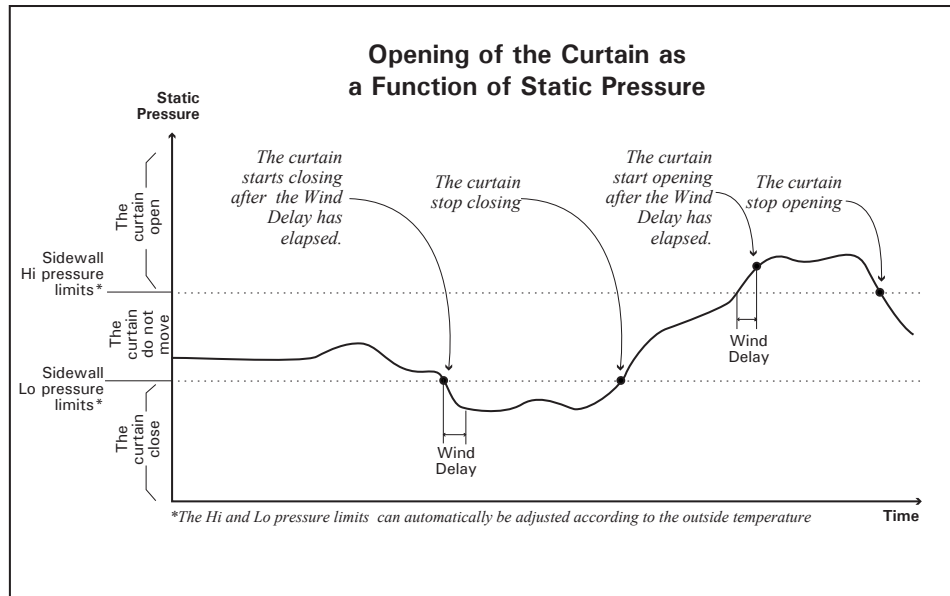
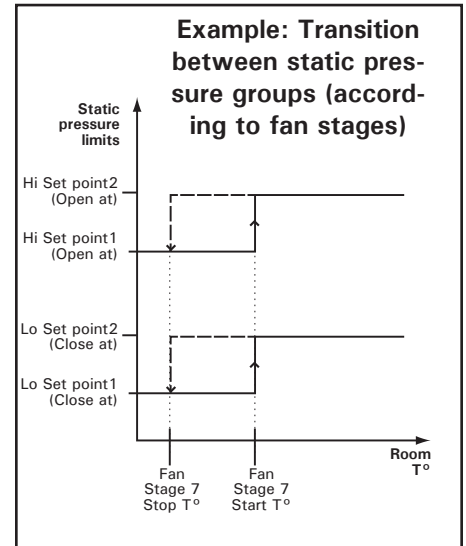

6.3.1.2. Settings

1. Select:

- » 11. Tunnel Curtain – or press “E” *
- or
- » 12. Tunnel Curtain 2**

* This menu is accessible if the first tunnel curtain is enabled (s.4.5).

** This menu is accessible if the 2nd inlet output is used as a tunnel curtain (sec. 4.5).

Tunnel Curtain	
Tunnel Starts at Stage	3
Minimum Animal Age	0 days
Animal age #1	21 days
Maximum Tunnel Stage #1	10
Animal age #2	28 days
Maximum Tunnel Stage #2	10
Animal age #3	35 days
Maximum Tunnel Stage #3	10
Close Curtain at	.050 "WC
Open Curtain at	.080 "WC
Static Pressure Settings 2	
Start at Stage #	10
Close Curtain at	.050 "WC
Open Curtain at	.080 "WC
Open Time	60 sec
Close Time	60 sec
Off Time	10 sec
Exit: Press Back Change: Press +/-	
Press ▲▼ to select an item	

2. Set the following parameters:

 **The parameters below will only appear this way if the selected tunnel curtain operates according to the static pressure level (see section 4.5).**

Tunnel Curtain starts at Stage — The curtain starts being used when the start temperature of this fan stage is reached.

Minimum Age — Animal age below which the tunnel curtain remains closed. Tunnel ventilation can only be enabled when this age is reached. This parameter ranges from 1 to 450 days. Decrease the value to Off if you want to disable this function. **Accessible if the “Multiple Tunnel Stage w/ Age” function is disabled (sec. 4.5).*

Animal Age #1-3 — This is the animal age below which tunnel ventilation is limited to the specified maximum tunnel stage. This parameter ranges from -5 to 450 days. Negative day values are used to prepare the room before letting the animals enter the building. Decrease the value to Off if you want to disable this function. **Accessible if the “Multiple Tunnel Stage w/ Age” function is enabled (sec. 4.5).*

Maximum Tunnel Stage #1-3 — This is the maximum tunnel stage that can be performed when the animals are younger than the specified age. Note that maximum tunnel stage #3 is automatically set to the highest fan stage. **Accessible if the “Multiple Tunnel Stage w/ Age” function is enabled (sec. 4.5).*

Open / Close Curtain at — Set the static pressure limits below/above which the tunnel curtain opens and closes according to a timer. This parameter ranges from 0 to 0.2 inches of water (0 to 50Pa).

Static Pressure Settings 2 — The following procedure shows how to set the tunnel curtain’s second group of pressure settings. **Refer to the previous section for further information on these parameters. Note that the following menus are only accessible if the second group of pressure settings is enabled (sec. 4.5).*

Start at stage — Select the fan stage at which the controller switches from its regular pressure settings to the second group of pressure settings. This menu only is only shown if the “Stage” transition method between groups of pressure settings is selected (sec. 4.5).

Open/Close Limits (second settings) — Set the static pressure level below which the curtain closes and above which it opens when the second groups of static pressure settings is used. This parameter ranges from 0 to 0.2 inches of water (0 to 50Pa).

Open / Close / Off Times — Set the curtain’s opening and closing times to the desired value. This timer is used when the static pressure level exceeds the high or low pressure limits and are common to both static pressure groups. This parameter ranges from 0 to 30 minutes.

6.3.2. Timer-Based Curtain

6.3.2.1. Principle of Operation

The controller can control 2 timer-based tunnel curtains. To enable the first tunnel curtain, answer "Yes" to the "Use Tunnel" question in the installation menu and set the tunnel mode to "Time". To use the second inlet output as a timer-based tunnel curtain, enable the 2nd inlet output in the installation menu and set it as being a tunnel curtain that works according to time (refer to section 6.5).

The tunnel curtains start opening when the fan stage that signals the beginning of tunnel ventilation is reached. At that moment, the curtains open according to the opening time that is associated with that stage. When half of the opening time has elapsed, the stage's fans are activated. The activation of every consecutive fan stage causes the curtains to open further.

Animal Age: It is possible to limit the use of tunnel ventilation according to the age of the animals: you can either specify the minimum age at which tunnel ventilation can start being used, or you can specify the maximum allowable tunnel stage associated with three different ages (refer to section 4.5 to enable/disable the *Multiple Tunnel w/ Age* function).

Opening Times: The curtain's opening times are associated with the activation of the fan stages. When the start temperature of a stage is reached, the curtain opens according to the opening time associated with the stage.

6.3.2.2. Settings

The following settings are only available if the tunnel curtain operates in timer mode. Refer to section 4.5 to enable this operating mode.

1. Select:
 - » 11. Tunnel Curtain – or press "E" *
 - or
 - » 12. Tunnel Curtain 2**

* This menu is accessible if the first tunnel curtain is enabled (s.4.5).

** This menu is accessible if the 2nd inlet output is used as a tunnel curtain (sec. 4.5).

2. Set the following parameters:

 **The parameters below will only appear this way if the selected tunnel curtain operates according to a timer (see section 4.5).**

Tunnel Curtain starts at Stage – The tunnel curtain starts opening when the start temperature of this fan stage is reached.

Minimum Age – Animal age below which the tunnel curtain remains closed. Tunnel ventilation can only be enabled when this age is reached. This parameter ranges from 1 to 450 days. Decrease the value to Off if you want to disable this function. *This parameter is accessible if the "Multiple Tunnel Stage w/ Age" function is disabled (sec. 4.5).

Tunnel Curtain	
Tunnel Starts at Stage	3
Minimum Animal Age	0 days
Animal age #1	21 days
Maximum Tunnel Stage #1	10
Animal age #2	28 days
Maximum Tunnel Stage #2	10
Animal age #3	35 days
Maximum Tunnel Stage #3	10
Open and Close Time	
Total Curtain Run Time	2:00(m:s)
Stage 3	0:30(m:s)
Stage 4	0:30(m:s)
...	
Stage 16	0:00(m:s)
Exit: Press Back Change: Press +/- Press ▲▼ to select an item	

Animal Age #1-3 – This is the animal age below which tunnel ventilation is limited to the specified maximum tunnel stage. This parameter ranges from -5 to 450 days. Negative day values are used to prepare the room before letting the animals enter the building. Decrease the value to Off if you want to disable this function. *Accessible if the "Multiple Tunnel Stage w/ Age" function is enabled (sec. 4.5).

Maximum Tunnel Stage #1-3 – This is the maximum tunnel stage that can be performed when the animals are younger than the specified age. Note that maximum tunnel stage #3 is automatically set to the highest fan stage. *Accessible if the "Multiple Tunnel Stage w/ Age" function is enabled (sec. 4.5).

Total Curtain Run Time – Set the total time that is required for the tunnel curtain to open totally. The sum of all opening times below cannot exceed this time limit. This parameter ranges from 0 to 15 minutes.

Curtain Opening Times – Select the opening time that is associated with the activation of each fan stage. This parameter ranges from 0 to 15 minutes.

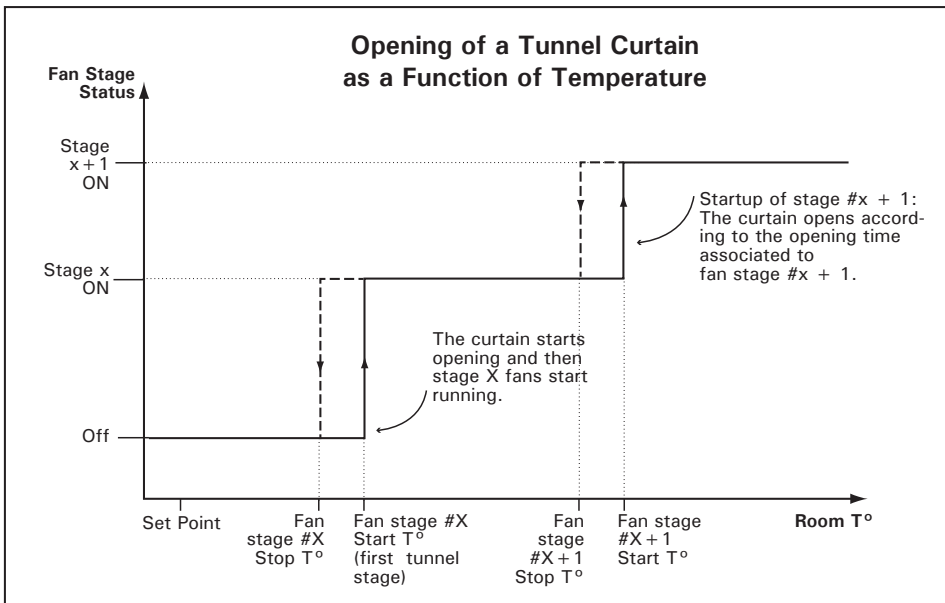

6.4. Inlets & Vent Doors

1. First Inlet Output:

The first inlet output can either be used to control vent doors (pressure or timer-based) or it can be used to connect up to 10 external air inlet modules such as the SB3000 (potentiometer feedback control) or the SB3500 (timer-based inlet control).

To determine the use of the first inlet output, set the *"Vent Door Mode"* parameter properly in the installation menu (see section 4.5).

2. Second Inlet Output:

The 2nd inlet output can either be used to control an attic vent, a sidewall vent (vent door) or a supplementary tunnel curtain. To enable the second inlet output, select the proper output function in the installation menu (*"Use 2nd inlet?"* question in section 4.5).

The air inlet that is connected to the second output can either operate according to the static pressure level or in timer mode, as a function of room temperature. Refer to section 4.5 to choose the proper function and operating mode of the second inlet output (*"Attic Mode"* or *"2nd Inlet Mode"* parameter).

6.4.1. Inlet on External SB Modules

The first inlet output can be used to connect external air inlet controllers (SB modules). To program the air inlets that are connected to these SB modules, you must refer to the user's manual enclosed with your particular module (SB3000 or SB3500)

When external SB modules are used to define the position of the air inlets, the CC24-7 Elite can still ask these modules to adjust the inlet opening when the static pressure or the room temperature gets out of range. This section explains how these opening compensation methods work.

No compensation is applied on the inlets at the startup of a new fan stage. When a fan stage starts, the controller resets the current compensation values and redefines them according to the pressure & temperature conditions measured at that time.

The SB3500 limits the compensation value that can be applied on the air inlets to 50% of their regular opening. If the controller sends a compensation request that exceed this limit the SB Module just won't consider it and won't move the inlet any further.

• Static Pressure Compensation:

A compensation can be used to ensure a certain uniformity in the static pressure level in the room. This static pressure compensation allows opening or closing inlets further when the static pressure level gets out of range.

When the static pressure level exceeds the normal range (above the Hi Pressure Set point or below the Lo Pressure Set Point), the controller waits for the Wind Effect Delay to make sure this unusual pressure condition is not temporary. If the pressure is still out of range after this delay has elapsed, the inlet compensation (%) is applied on the opening of all inlets: they close further by their respective compensation value (%) when the pressure level is too low [point A on the graph] or open further by their compensation value (%) when the pressure level is too high [point C on the graph]. The controller then waits for the Wind Effect Delay once again. If the pressure level is still out of range afterwards, the opening compensation is applied once more. This cycle is repeated up until the pressure gets back in the normal range or until a new stage starts. When the pressure level gets back to the normal range [points B & D on the graph], all inlets keep their compensated position until the beginning of a new stage. No compensation is applied on the inlet opening when a new stage starts.

• Temperature Compensation:

A compensation can be activated to ensure a certain uniformity in the room temperature: the air inlet positions are automatically adjusted when the temperature reading of the inlets' probes differs from the average room temperature read by the controller.

The inlet temperature compensation is expressed as a percentage per degree difference between the average controller temperature and the average reading of the probes assigned to the inlet. It determines by how much the inlet must open or close to help reduce the temperature differences in the building. For each degree above or below the average temperature, the inlet will open or close using the compensation value assigned by the user. For example, if the compensation value is set to 2%/°F and the inlet's probes read 3°F above the average controller temperature, the inlet will open 6% further to help decrease the temperature in that zone. Refer to section 4.6.1 to assign the inlets' temperature probes.

If a temperature compensation has to be applied on the position of the air inlets, the controller only sends a compensation request of 1% at a time. Refer to the installation menu to specify the frequency at which the 1% compensation must be applied ("Send Compensation Each" parameter in section 4.5).

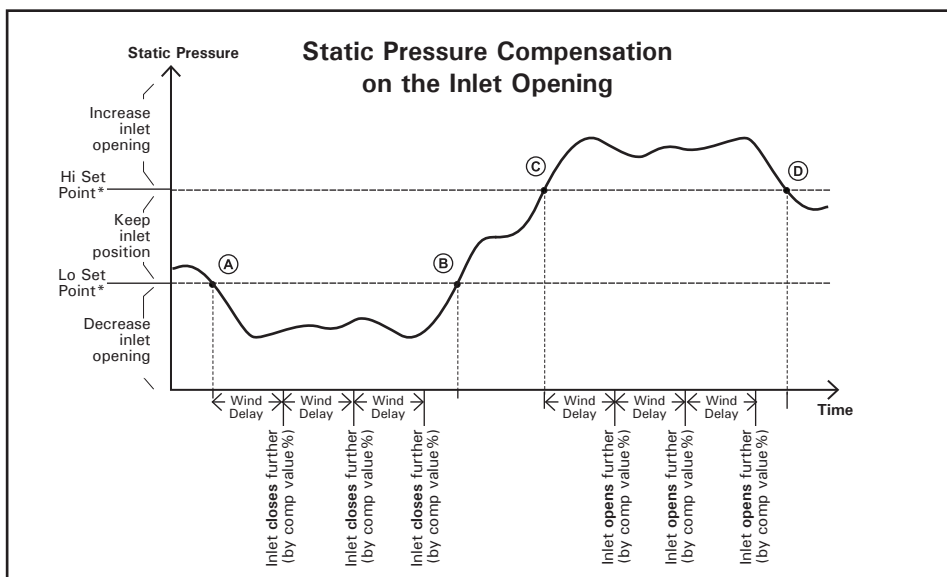

6.4.1.1. Settings

1. Select:

» **10. Inlet Compensation ***

** This menu is accessible if an inlet is enabled in the Installation menu: "Vent Door Mode" is set to "Ext" and number of inlets is greater than 1 (section 4.5).*

Inlet Compensation	
Show Settings of :	Inlet 1
T° Opening Comp.	5 %/°F
SP Comp.	5 %
Static Pressure Low	.050 "WC
Static Pressure High	.080 "WC
Wind Delay	30 sec

2. Set the following parameters: Refer to the previous section to get further information on these parameters.

Show Settings of — Select the proper inlet then set the compensation openings of each inlet separately:

T° Opening Compensation — Select the opening percentage that must be added or removed when the temperature compensation is applied on the inlet openings. This parameter ranges from 0 to 100%/°F.

SP Compensation — Select the opening percentage that must be added or removed when the static pressure compensation is applied on the inlet openings. This parameter ranges from 0 to 10% **This parameter is available if the static pressure compensation function on air inlets is enabled in section 4.5.*

Low Set Point — The static pressure compensation starts when the pressure level decreases below this level. This parameter ranges from 0 to 0.40"WC. **This parameter is common to all inlets and is available if the static pressure compensation function is enabled in section 4.5.*

High Set Point — The static pressure compensation starts when the pressure level increases beyond this level. This parameter ranges from 0 to 0.40"WC. Note that the high pressure limit must be greater than the low limit. **This parameter is common to all inlets and is available if the static pressure compensation function is enabled in section 4.5.*

Wind Delay — Each time this delay has elapsed and the pressure exceeds the normal range, the static pressure compensation is applied on the opening of all air inlets. This parameter ranges from 30 to 900 seconds. **This parameter is common to all inlets and is available if the static pressure compensation function is enabled in section 4.5.*

6.4.2. Pressure-based Vent Doors

6.4.2.1. Principle of Operation

When a vent door operates according to the level of static pressure, it closes in timer mode when the pressure level gets lower than the Low pressure set point or opens in timer mode when the pressure level exceeds the Hi pressure set point.

The controller can control 2 pressure-based vent door outputs. To enable the first vent door output, set the "Vent Door Mode" to "SP" in the installation menu. To use the second inlet output as a pressure-based vent door, enable the 2nd inlet output in the installation menu and set it as being a sidewall vent that works according to static pressure (refer to section 6.5).

Pre-opening Delay: If the variables fans are not used during minimum ventilation, the vent doors open during a pre-opening time before the fans start running. The same delay is used to close the vent doors when the fans stop. Refer to section 4.5 to set the vent doors' pre-opening delay.

Hand icon: If an attic vent is used, the vent doors will not open until the transitional fan stage is reached (see section 6.4.3).

Groups of static pressure settings: Two groups of high/low static pressure settings can be defined. The second group of settings either starts being used at the start-up of a chosen fan stage or when the outside temperature reaches a user-defined value. The following graphs sum both cases.

1. Transition between static pressure settings – based on the ventilation stages:

Example: When the start temperature of stage 5 is reached, the vent doors start operating according to the second group of static pressure settings; therefore, new high and low pressure limits are used. The initial settings become used once again when the room temperature decreases below the stop temperature of stage 5.

2. Transition between static pressure settings – based on the outside temperature:

Example: When the outside temperature falls and reaches the outside temperature influence parameter value + 5°F (2.8°C), a gradual transition between the two groups of static pressure settings starts being done. The second group of settings is fully used when the outside temperature reaches the "outside influence temperature" value.

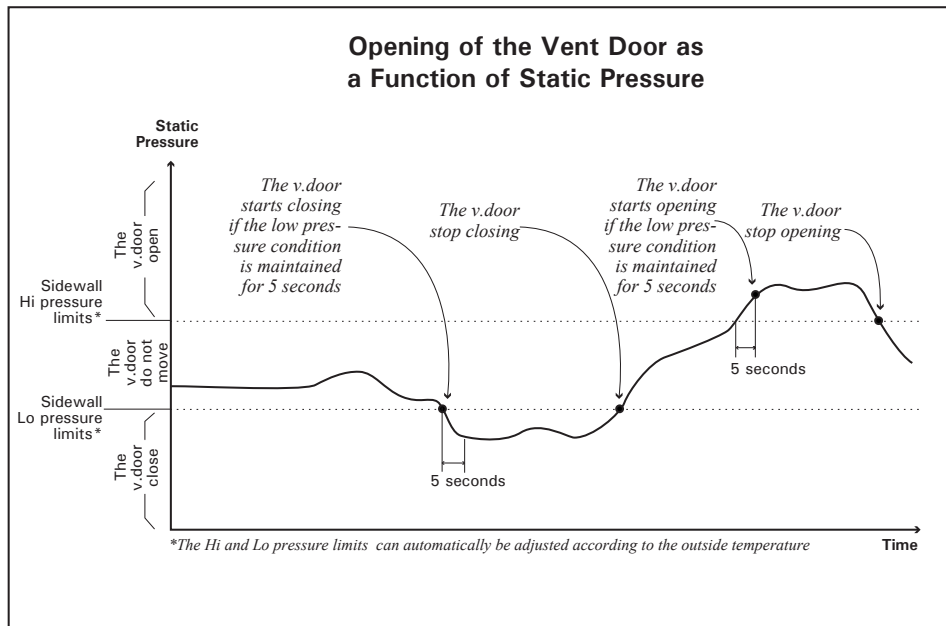
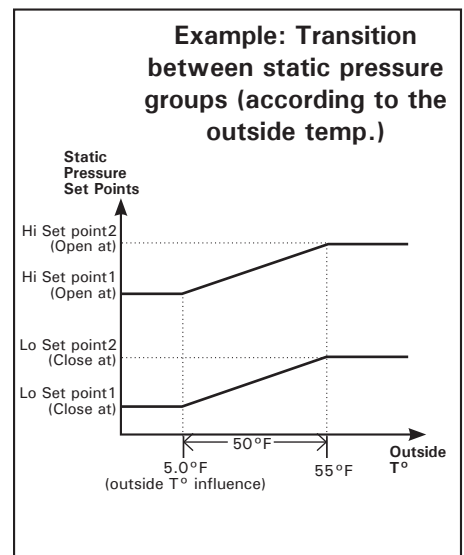
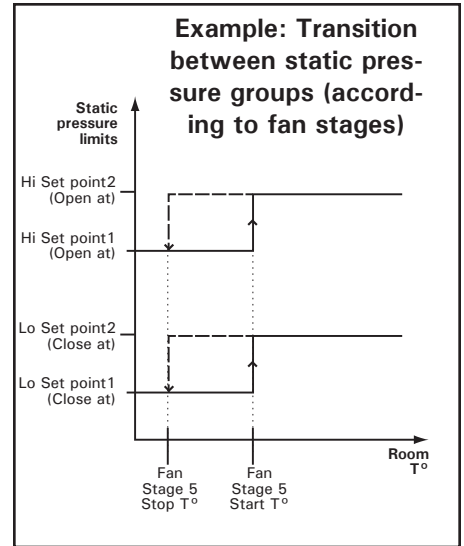

6.4.2.2. Settings

1. Select:

- » 10. Vent Doors / Static Pressure*
- or
- » 12. Vent Doors 2 / Static Pressure**

* This menu is accessible pressure-based vent doors are enabled (sec. 4.5).

** This menu is accessible if the 2nd inlet output is used as a sidewall vent (sec. 4.5).

Vent Doors / Static Pressure	
Close Vent Doors at	.050 "WC
Open Vent Doors at	.080 "WC
Static Pressure Settings 2	
Start at Stage #	10
Outside T° Influence	50.0 °F
Close Vent Door at	.050 "WC
Open Vent Door at	.080 "WC
Open Time	60 sec
Close Time	60 sec
Off Time	60 sec
Close Vent Doors at Stage	None
Exit: Press Back Change: Press +/-	
Press ▲▼ to select an item	

2. Set the following parameters:

Open/Close Limits — Set the pressure level below which the vent doors close and above which they open. These parameters range from 0 to 0.2 inches of water column (0 to 50Pa).

Static Pressure Settings 2 — The following procedure shows how to set the second group of pressure settings. *This parameter is accessible if the second group of pressure settings is enabled (s.4.5).

Start at stage — Select the fan stage at which the controller switches from its regular static pressure settings to the second group of static pressure settings. *This parameter is accessible if the second group of pressure settings uses the "Stage" transition mode (sec. 4.5).

Outside T° Influence — Set the outside temperature below which the controller fully switches to the second group of pressure settings. *This parameter is accessible if the second group of pressure settings uses the "Out T°" transition mode (sec. 4.5).

Open/Close Limits (second settings) — Set the static pressure level below which the vent doors close and the temperature above which they open when the second groups of static pressure settings is used. The open and close limits can be adjusted from 0 to 0.2 inches of water column (0 to 50Pa). *This parameter is accessible if the second group of pressure settings is enabled (s.4.5).

Open Time — When the static pressure exceeds the Hi pressure set point, the vent doors open during this delay. This parameter ranges from 0 to 900 seconds.

Close Time — When the static pressure level decreases below the Lo pressure set point, the vent doors close during this delay. This parameter ranges from 0 to 900 seconds.

Off Time — After they have moved, the vent doors have then stay still during the "OffTime". This delay ranges from 0 to 900 seconds.

Close Vent Doors at Stage — Select the fan stage at which the vent doors must close. This option can be used to close the vents at the startup of a tunnel ventilation for instance. Select "None" to deactivate this function.

6.4.3. Timer-Based Vent Doors

 **This section only applies to a vent door output that uses the built-in timer of the CC24-7 Elite control; if the vent door uses the timer of an external SB 3500 module, refer to section 6.4.1.**

6.4.3.1. Principle of Operation

The controller can control 2 timer-based vent door outputs. To enable the first vent door output, set the "Vent Door Mode" to "Time" in the installation menu. To use the second inlet output as a timer-based vent door, enable the 2nd inlet output in the installation menu and set it as being a sidewall vent that works according to a timer (refer to section 6.5).

When a vent door output works in timer mode, you must specify the total amount of time required to fully open the vent. You must then associate an opening with the startup of each fan stage (the opening is defined as a percentage of the total opening time). As the room temperature increases and new stages are activated, the vent doors will open or close accordingly.

An opening step is also added when a variable fan stage starts (this applies to stages 1 and 2 only). This step is called "Stage x Min". In the example above, "Stage x Min" represents the point where stage 1 fans start running at their minimum intensity. The regular opening of the vent door in stage 1 is reached when the fans reach their full intensity.

Vent Doors in Minimum Ventilation: During the "Off Time" portion of a minimum ventilation cycle, the vent doors close to their "Stage 0" position; during the "On Time", they open to position associated with stage 1 (or Stage 1 Min – if variable fans are used).

 **If an attic vent is used, the vent doors will not open until the transitional fan stage is reached (see section 6.4.3).**

Automatic Reset of the Vent Doors' Position: Resetting the actuator's position clears all accumulated time offsets caused by the frequent openings and closings of vent doors. The controller resets the actuator's position at regular interval to make sure the vent doors' position is always accurate. This reset is performed automatically according to one of these two methods:

- **Reset the minimum position only (Close mode):** Each time a reset is performed, the vent doors totally close. Once the actuator's position is reset, they return to their previous position
- **Reset toward the nearest position (Open/Close mode):** Each time a reset is performed, vent doors fully open if their current opening already was higher than 25%; otherwise, the controller closes vent doors to reset the actuator's position. This way, they do not close when the room temperature already asks for a large opening.

 **Make sure limit switches are located at both ends of the actuators when using this resetting method.**

6.4.3.2. Settings

This procedure shows how to program the vent doors that are using the built-in timer of the controller and does not apply to vent doors that are using the timer of an external SB 3500 module. Refer to section 4.5 to choose the operating mode of the vents.

1. Select:

- » 10. Vent Doors / Static Pressure*
- or
- » 12. Vent Doors 2 / Static Pressure**

* This menu is accessible if timer-based vent doors are enabled (sec. 4.5).

** This menu is accessible if the 2nd inlet output is used as a sidewall vent (sec. 4.5).

Vent Doors / Static Pressure	
Open and Close Times	
Stage 0	10 %
Stage 1 Min	10 %
Stage 1	10 %
Stage 2 Min	10 %
Stage 2	10 %
Stage 3	10 %
...	
Stage 16	10 %
Vent Door Run Time	2:00 m:s
Auto Reset Mode	OPEN/CLOSE
Auto Reset Time	6:00A
Auto Reset.	Every 3 days
Open / Close Time	120 sec
Start Manual Reset Now?	No
Exit: Press Back Change: Press +/- Press ▲▼ to select an item	

2. Set the following parameters:

Stage 0 — This is the position of the vent door when the fans are not running in minimum ventilation ("Off Time" portion of the minimum ventilation timer).

Stage x Min — Assign a vent door position to the start-up of each variable-speed fan stage (for stages 1 & 2 only).

Stage x — Assign a vent door position to each fan stage.

Vent Door Run Time — Specify the exact time that is required to reach the actuator's maximum limit switch. The controller will limit opening of the vent doors vent according to this time value.

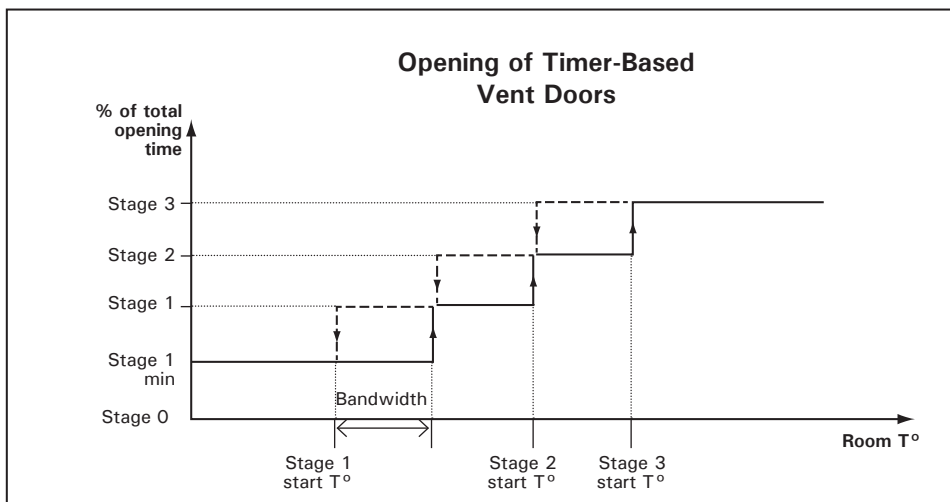

Auto Reset Mode — Select the desired reset mode for the vent door actuator: choose “Open/Close” to reset the actuator toward its nearest position; select “Close” to reset it towards its closed position only; select “Off” to disable the auto-reset function. **Refer to the previous section for further information about resets.*

Auto Reset Time — Select the time at which the actuator reset is performed.

Auto Reset Every — Select the frequency at which the actuator is reset. This parameter ranges from 1 reset every 1 to 7 days.

Open / Close Time (Advanced) — During a reset, the controller opens or closes the vent doors during this delay, or up until a limit switch is reached. By default, this value is equal to the total run time of the actuator. **Accessible from the factory mode only.*

Start Manual Reset Now? — Select “Yes” to reset the vent door position now.

6.4.4. Attic Vent

In order to extract the warm air from the ceiling, the attic vent can open prior to the opening of sidewall vents.

The second inlet output of the CC24-7 Elite can be used to control an attic vent (pressure or timer-based vent). To enable this vent, set the status of the second inlet output to “Attic” in the installation menu and then select its operating mode: “Time” or “SP” (see section 4.5).

6.4.4.1. Pressure-based Attic Vent

Opening of the Attic Vent: When it is based on the static pressure level, the attic vent moves according to the pressure variations in the building. This is the exact same principle as for the pressure-based vent door outputs. Refer to section 6.4.2 to see how a pressure-based actuator moves.

Activation Period & Transition: When a pressure-based attic vent is used, the air intake inside the building is exclusively provided by the attic vent until the room temperature reaches the startup point of the fan stages that asks for a transition (“Attic transition stage”). When this transition begins, the attic vent stops moving and the vent doors open during the “Transition Pre-Open Time”. After this delay, the attic vent either stops moving or opens completely (depending on the chosen option) and the vent doors start working normally. The attic vent will close when the room temperature rises and reaches a user-defined fan stage (“Close at” stage).

Pre-opening Delay: If the variables fans are not used during minimum ventilation, the attic vent opens during a pre-opening time before the fans start running. The same delay is used to close the attic vent when the fans stop. Refer to section 4.5 to set the attic vent pre-opening delay.

1. Select:
 - » 12. Attic Settings*

** Available if the 2nd inlet output is used to control an attic vent (sec. 4.5).*

2. Set the following parameters: *Refer to section 6.4.2 to get further information on these parameters.*

 **The parameters below will only appear this way if the attic vent operates according to the static pressure level (see section 4.5).**

Attic Inlet	
Close Attic at stage	3
Attic transition stage	2
Attic state in transition	As is/Open
Transition Pre-Open	.10 sec
Close Attic at	.050 "WC
Open Attic at	.080 "WC
Open Time	60 sec
Close Time	60 sec
Off Time	60 sec
Exit: Press Back Change: Press +/-	
Press ▲▼ to select an item	

Close Attic at Stage — Set the fan stage at which the attic vent must close. The air intake in the building is exclusively provided by the vent doors at the startup of this stage. The closing stage must be higher than the transition stage that is defined below.

Attic Vent Transition Stage — The air intake in the building is exclusively provided by the attic vent up until the room temperature reaches the start temperature of the chosen fan stage. Select the fan stage at which the air intake must start being provided by the vent doors (fan stage 1 to 6).

Attic State in Transition — Specify what the attic vent must do during a transition stage: it can either stay in place (“As is”) or it can open completely (“Open”).

Transition Pre-Open — Select during how much time the vent doors must open prior to moving the attic vent when the transitional fan stage is reached. At the end of this delay, the air intake is provided by both the attic vent and the vent doors.

Open/Close Limits — Set the pressure level below which the attic vent closes and above which it opens. These parameters range from 0 to 0.2 inches of water column (0 to 50Pa).

Open Time — When the static pressure exceeds the Hi pressure set point, the attic vent opens during this delay. This parameter ranges from 0 to 900 seconds.

Close Time — When the static pressure level decreases below the Lo pressure set point, the attic vent close during this delay. This parameter ranges from 0 to 900 seconds.

Off Time — After is has moved, the attic vent then stays still during the “Off time”. This delay ranges from 0 to 900 seconds.

6.4.4.2. Timer-based Attic Vent

Opening of the Attic Vent: When an attic vent works in timer mode, you must specify the total time that is required to fully open the vent. You must then associate an opening time to the startup of each fan stage that precedes the transition stage. As the room temperature increases and new stages are activated, the attic vent will open or close accordingly.

Activation Period & Transition: When a timer-based attic vent is used, the air intake inside the building is exclusively provided by the attic vent until the room temperature reaches the startup point of the fan stages that asks for a transition (“Attic transition stage”). When the transition begins, the vent doors start operating normally and the attic vent either stops moving or opens completely (depending on the chosen option). The attic vent finally closes when the room temperature reaches the fans stage that asks for it to close (“Close attic at stage”). The air intake becomes exclusively provided by the vent doors at that moment.

Attic Vent in Minimum Ventilation: A pre-opening delay must be defined to open the attic vent when the fans are running in minimum ventilation (“On Time” portion of the minimum ventilation timer). Note that the pre-opening is made prior to the activation of the fans at the beginning of each cycle.

1. Select:

» 12. Attic Settings*

* Available if the 2nd inlet output is used to control an attic vent (sec. 4.5).

2. Set the following parameters:

 **The parameters below will only appear this way if the attic vent operates according to a timer (see section 4.5).**

Close Attic at Stage — Set the fan stage at which the attic vent must close. The air intake in the building is exclusively provided by the vent doors at the startup of this stage. The closing must be higher than the transition stage defined below.

Attic Transition Stage — Select the fan stage at which a transition is made from the attic to the sidewall air intake. When this stage is reached, the attic vent either stops moving or opens for its total run time (depending on the transition state below) and the vent doors start operating normally.

Attic State in Transition — Specify what the attic vent must do during a transition stage: it can either stay in place (“As is”) or it can open for its total run time (“Open”).

Total Attic Run Time — Specify the exact time that is required to reach the actuator’s maximum limit switch. The controller will limit opening of the attic vent according to this time value.

Stage x Opening Time —Assign an opening time of the attic vent to all fan stages that precede the transition stage. *The sum of all stage openings must be shorter than the Total Attic Run time if the transition mode is set to “Open” above.

Pre-Open Attic Delay — Assign the opening time of the attic vent for the minimum ventilation mode: the attic vent will open during this amount of time just before the fans start running and will stay in place until the fans stop during a minimum ventilation cycle..

Attic Inlet	
Close Attic at stage	3
Attic transition stage	2
Attic state in transition	As is/Open
Open and Close Time	
Total Attic Run Time	2:00 (m:s)
Stage 1	0:30 (m:s)
Pre-Open Attic delay	10 sec
Exit: Press Back Change: Press +/- Press ▲▼ to select an item	

6.5. Cooling Outputs

The controller has 4 cooling outputs that can be used to operate cooling devices such as mist units. The intensity of these outputs increases gradually as the house temperature increases. The following diagram illustrates the cooling outputs' operation.

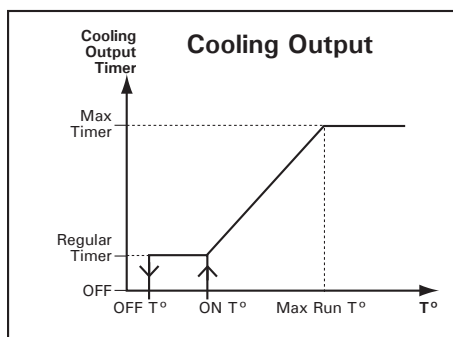

The cooling output starts operating according to a timer (On Time & Off Time) when its start temperature is reached. The output's timer gradually changes as the temperature increases. It reaches the max timer settings (Max On Time & Max Off Time) when the house temperature reaches the *Maximum Run Temperature*. Start and stop temperatures of cooling outputs are related to the house set point. This means that when the house set point changes, start and stop temperatures are adjusted consequently.

You can specify an operating time range in order to stop cooling outputs during night.

Since they are related to the set point, the On and Off temperatures of the cooling outputs are likely to change with time. For this reason, a temperature limit can be defined to avoid activating the cooling outputs when the room temperature is not high enough to ensure water evaporation (see following graph).

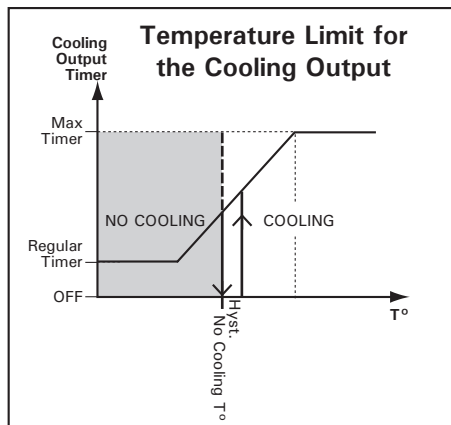

1. Select:

- » 14. Fan/Cool./Nat. Temp. Settings
- » 2. Cooling Temperature Settings*

* Available if cooling outputs are enabled (sec. 4.5).

Cooling Temperature Settings	
Cooling 1	
Start Temperature	95.0 °F
Stop Temperature	94.0 °F
Maximum Temperature	100.0 °F
On Time 1	1:00 (m:s)
Off Time 1	3:00 (m:s)
On Time 2	2:00 (m:s)
Off Time 2	12:00 (m:s)
Start at	6:00 A
Stop at	9:00 P
Cooling 2	
Start Temperature	95.0 °F
Stop Temperature	94.0 °F
...	
No cooling under	72.0 °F
Hysteresis	0.5 °F
Exit: Press Back Change: Press +/-	
Press ▲▼ to select an item	

2. Set the following parameters:

Start Temperature — Set the temperature at which the cooling output starts operating using the first timer. This parameter ranges from the set point to 120°F (48.9°C).

Stop Temperature — Set the temperature below which the cooling output stops. This parameter ranges from 0.5°F (0.3°C) below the start temperature to -40°F (-40°C).

Maximum Temperature — Set the temperature at which the cooling output switches to the second timer. This parameter ranges from 0.5°F (0.3°C) above the start temperature to 120°F (48.9°C).

On Time 1 & 2 — Set both timers' On and Off times to the desired values. This parameter ranges from 0 to 30 minutes.

Start / Stop at — Cooling outputs can only be activated over this period of time. This allows deactivating these outputs during night for instance.

No cooling under — The cooling output is automatically disabled when the average temperature of its probes falls below the "No cooling under" temperature. Set this parameter to the desired value (from -40.0°F to 85.0°F).

Hysteresis (Advanced) — An hysteresis is used to restart the cooling output when the temperature rises above the "No Cooling T°". By default, the hysteresis is set to 0.5°F. *This parameter is only accessible with the factory password.

6.6. Natural Ventilation

6.6.1. Principle of Operation

The curtains operate according to the average temperature in their respective zones. Their opening and closing temperatures are related to the room set point, which means they are adjusted consequently when a change in the set point occurs. Refer to section 4.6.1 to assign the temperature probes located in each natural zone.

- Natural ventilation begins when the room temperature reaches the start temperature of a user-defined fan stage (*Start Natural at Stage*). At that moment, the controller opens all natural ventilation curtains during their respective *Initial Opening Time*.

- Once the controller is in natural ventilation, the curtains start operating in timer mode: they open according to an opening cycle (*Open Time & OffTime*) when the average temperature in their respective zone is above the *Open At* temperature; they close according to the closing cycle (*Close Time & OffTime*) when the temperature in their zone is lower than the *Close At* temperature.

- Natural ventilation is disabled at the startup of the first tunnel stage or when the room temperature decreases to the natural ventilation's stop temperature. When it stops, the controller fully closes all natural ventilation curtains.

6.6.2. Transition Between Natural & Tunnel Ventil.

1. NATURAL VENTILATION -> TUNNEL VENTILATION:

When the room temperature increases and reaches the *Open at* temperature of the natural ventilation curtain [*point A on the picture*], the curtain opens in timer mode [*point B on the picture*]. If the tunnel curtain is also used in natural ventilation, it will also open following this timer. When the room temperature reaches the start temperature of the first tunnel stage [*point C on the picture*], the natural ventilation curtain stays still during the *Natural Close Delay* (5 minutes by default) then fully closes. Here is what happens to the tunnel curtain when the first tunnel stage is reached:

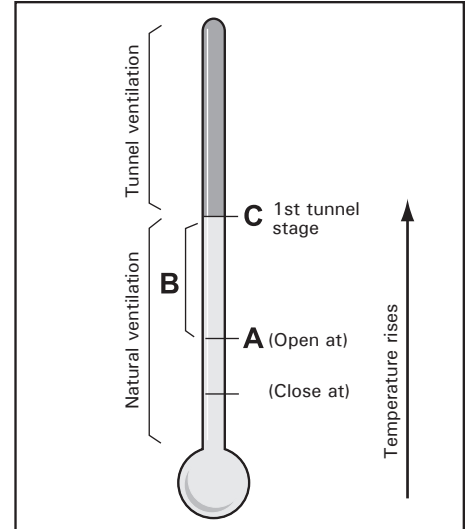

GRAPH 1
From natural to tunnel ventilation

- If the tunnel curtain is based on a timer:

If the tunnel curtain was not used in natural ventilation: The tunnel curtain opens to the position associated with the first tunnel stage. When it reaches half the opening of that stage, the fans start running.

If the tunnel curtain was used in natural ventilation: The tunnel curtain opens during its *Total Run Time* parameter value (sec. 6.3.2.2) then repositions itself to the opening associated with the first tunnel stage. This allows resetting the curtain's position before moving on to the tunnel ventilation mode.

- If the tunnel curtain is based on the static pressure:

If the tunnel curtain was not used in natural ventilation: The tunnel curtain opens during its *Pre Open Time* parameter value. When this delay has elapsed, the controller starts the fans and the opening of the curtain becomes based on the static pressure settings.

If the tunnel curtain was used in natural ventilation: The opening of the curtain becomes based on the static pressure settings at the start-up of the first tunnel stage.

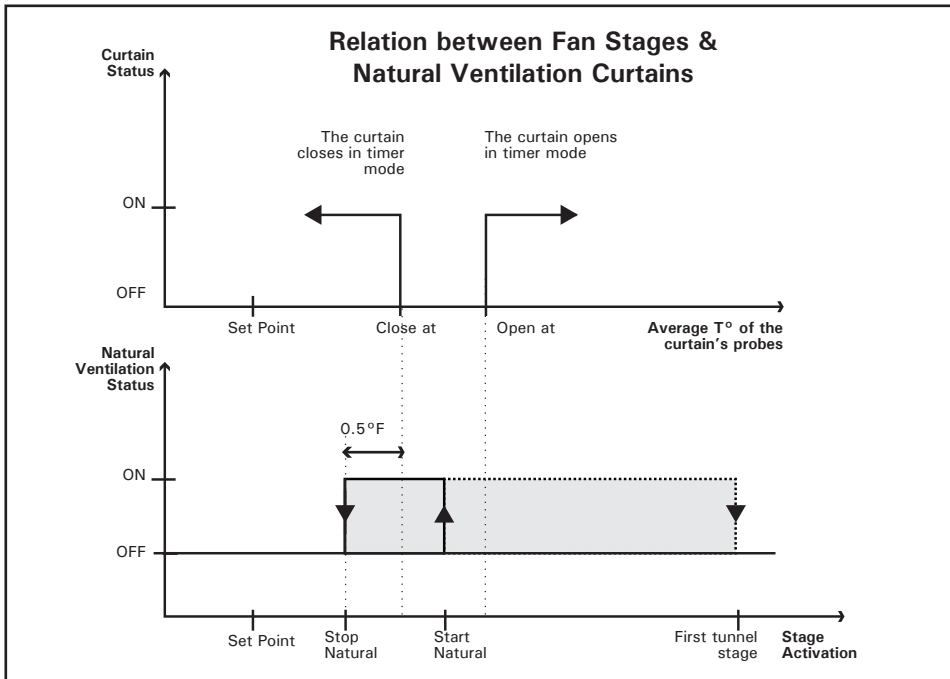

2. TUNNEL VENTILATION -> NATURAL VENTILATION:

If the tunnel curtain is not used in natural ventilation: When the room temperature falls and gets lower than the stop temperature of the first tunnel stage [point A], the controller re-enters in natural ventilation: it opens the natural curtain during the *Natural Open Delay* (5 minutes by default) and closes the tunnel curtain. When the delay has elapsed, the natural curtain starts operating according to the natural ventilation timer [point B].

If the tunnel curtain is used in natural ventilation: When the room temperature falls and gets lower than the stop temperature of the first tunnel stage [point A], the controller re-enters in natural ventilation and opens the tunnel and natural ventilation curtains during the *Natural Open Delay* (5 minutes by default). When this delay has elapsed, both curtains operate according to the natural ventilation timer [point B].

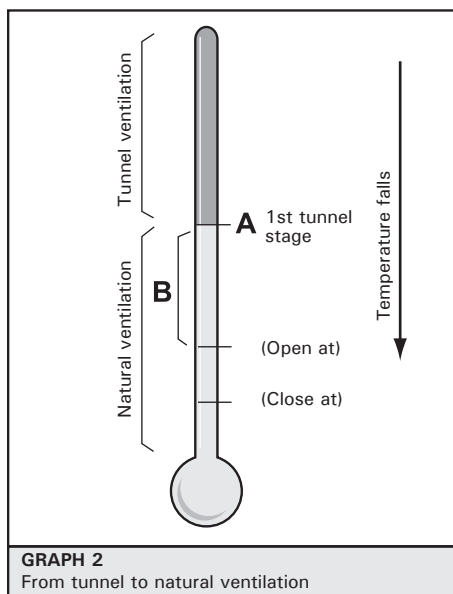

6.6.3. Settings

1. Select:

- » 14. Fan/Cool./Nat. Temp. Settings
- » 3. Natural Temperature Settings

** This menu is accessible if natural zones are enabled (sec. 4.5).*

Natural Zone Settings	
Natural Zone 1	
Open Curtain	84.5 °F
Close Curtain	85.5 °F
Open Time	0:30 (m:s)
Close Time	0:30 (m:s)
Off Time	1:00 (m:s)
Wind Delay	0:15 (m:s)
Initial Open Time	0:20 (m:s)
...	
Start Natural at Stage	4
Stop Natural at Stage	3
Tunnel Starts at Stage	6
Tunnel 2 Starts at Stage	6
Exit: Press Back Change: Press +/-	
Press ▲▼ to select an item	

2. Set the following parameters: *Refer to the previous section to get further information on these parameters.*

Make sure to select the right zone before adjusting these parameters. Press the down-arrow key to scroll the display and select the desired natural ventilation zone.

Open Curtain — Set the temperature above which the curtain opens according to a timer when the controller is in natural ventilation. This parameter ranges from the set point to 120°F (48.9°C). **This parameter must be set separately for each season.*

Close Curtain — Set the temperature below which the curtain closes according to a timer when the controller is in natural ventilation. **This parameter must be set separately for each season.*

Open / Close / Off Times — Set the timer that is used to open and to close the curtains in each natural zone (the Off time is common to both the opening and closing cycles). This parameter ranges from 0 to 15 minutes.

Wind Delay — When the controller is in natural ventilation and the temperature in a natural zone decreases below the “Close At” temperature or increases above the “Open At” temperature, the curtain in that zone only starts moving after the wind delay has

elapsed. This way, the controller does not open or close curtains when wind drafts cause temporary temperature variations. Set the wind delay to the desired value. This parameter ranges from 0 to 15 minutes.

Initial Open Time — Curtains of all natural zones open during their respective Initial Open Time when the controller enters in natural ventilation. This parameter ranges from 0 to 15 minutes.

Start Natural at Stage — Select the fan stage at which the controller enters in natural ventilation.

Stop Natural at Stage — Select the fan stage at which the controller exits from natural ventilation.

Tunnel/ Tunnel 2 Starts at Stage — This is the fan stage at which each tunnel curtain starts opening. This menu is shown for consultation purpose only and cannot be changed. **Refer to the tunnel ventilation chapter to modify the first tunnel stage.*

Natural Close Delay (Advanced) — This delay is launched at the beginning of the first tunnel stage. Once it has elapsed, the controller closes all curtains in natural zones. **Factory setting.*

Natural Open Delay (Advanced) — All natural ventilation curtains open during this delay when the controller switches from the tunnel mode to natural ventilation. **Factory setting.*

7. HEATERS

7.1. Heating Stages

The controller can operate up to 16 independent heating outputs. These outputs operate according to their start and stop temperature as illustrated below. Refer to section 4.5 to activate the heating outputs.

Heaters 1-8: These are the basic heating outputs of the controller.

Heaters' Hi Fire: The hi fire option allows adding a supplementary step to each activated heating output. Each heating output and hi fire step operates according to its own settings: probe assignment, relay selection and start/stop temperatures. In other words the hi fire option allows doubling the number of heating outputs. Refer to section 4.5 to activate the heaters' hi fire option.

Operating Temp. of the Heating Outputs:

- **Start Temperature:** The start temperature of each heating output is related to the set point. This means that if the set point changes, the start temperature is adjusted consequently.

- **Stop Temperature:** If the heating curve and the Hi/Lo Fire options are both disabled, the stop temperature of each heating output is related to the set point (this means that if the set point changes, the stop temperature is adjusted consequently). If the heating curve or the Hi/Lo Fire option is enabled, the stop temperature for a given heating output becomes based on the start temperature of the output (this means that if the start temperature of the output changes, the stop temperature is adjusted consequently).

1. Select:

» 13. Heater Start / Stop Temperature

Heater Start / Stop Temperature	
Current Temp. Set Point	80.0 °F
Heater 1	Curve Off
Start Temperature	78.0 °F
Stop Temperature	79.0 °F
or	
Stop Above Start Temp	1 °F
Heater 1 Hi	Curve Off
Start Temperature	78.0 °F
Stop Temperature	79.0 °F
or	
Stop Above Start Temp	1 °F

Exit: Press Back Change: Press +/-
Press ▲▼ to select an item

2. Set the following parameters.

 **The start and stop temperatures of a heating output cannot be modified if the heater uses a curve. Refer to the following section to enable/disable heaters' curves.**

Heaters' Start / Stop Temperatures — Set the start and stop temperature of each heating output. The stop temperature must be at least 0.5°F (0.3°C) greater than the start temperature for a given heater.

 **Nota. Due to some technical limitations, the Stop Temperature of the heating outputs can either be expressed as an absolute value (e.g. 79.0°F) or as a relative value (e.g. Stop 1°F above the Start Temperature).**

Hi Fires' Start / Stop Temperatures — Set the start and stop temperatures of each hi fire heating output. The stop temperature must be at least 0.5°F (0.3°C) greater than the start temperature for a given heater. **This parameter is available if the hi fire option is enabled (s.4.5).*

 **Nota. Due to some technical limitations, the Stop Temperature of the heating outputs can either be expressed as an absolute value (e.g. 79.0°F) or as a relative value (e.g. Stop 1°F above the Start Temperature).**

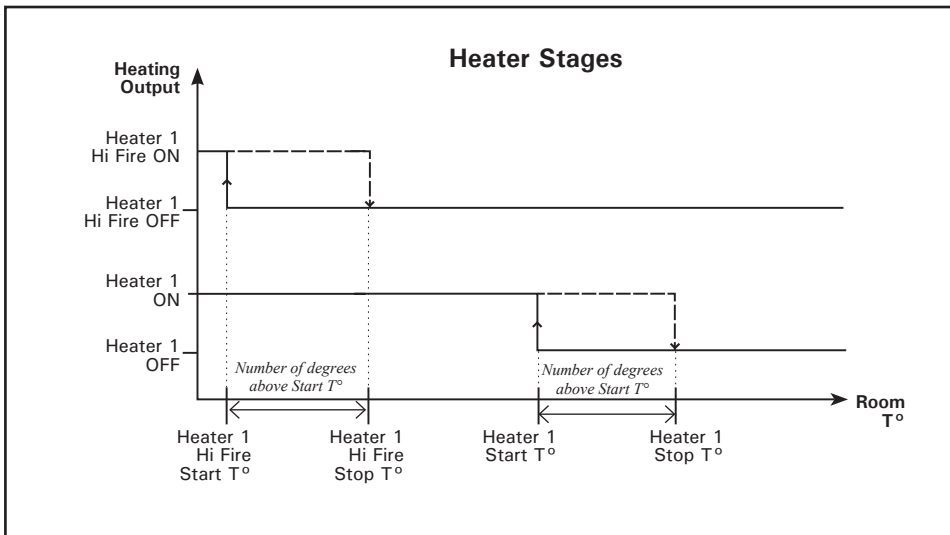

7.2. Heater Curve

7.2.1. Principle of Operation

This curve allows an automatic adjustment of the heaters' start temperature over time.

The heaters' start temperature changes using 10 steps. Each step specifies a day number and a start temperature for that day. The day number is based on the animal age. Once the 10 steps are defined, the curve must be activated. The controller then starts changing the heaters' start temperature every hour in a linear fashion between consecutive steps of the curve. When the last step is reached, the start temperature of the heaters for that day is maintained until a new batch starts and until the animal age is reset.

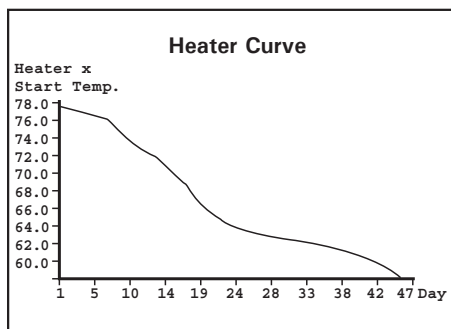

NOTE: Certain restrictions apply to reduce the risk of errors:

- The highest possible day number is 450.
- Decreasing day numbers is not allowed.
- Increasing the start temperature over time is not allowed.
- All ten steps must be specified. If you don't need ten different steps, repeat the last temperature for each unnecessary step.

Use the copy/paste function to program several heating output that use the same curve. Refer to section 7.2.3.

7.2.2. Settings

1. Select

- » 9. Curve Settings
- » x. Heater x Start Temperature*

* Available if the heaters' Offset curve is enabled (sec. 4.5).

Start Temp.	79.5°F
day 1	79.5°F
day 7	79.0°F
day 15	78.5°F
day 23	78.0°F
day 30	77.5°F
day 37	77.0°F
day 45	76.5°F
day 54	76.0°F
day 64	75.5°F
day 70	75.0°F
Curve Status	Off

Exit: Press Back Change: Press +/-
Press ▲▼ to select an item

2. Set the following parameters:

Hand icon: *The curve steps can only be modified while the curve is off.*

Day Number — Set the day for each of the 10 steps. This number corresponds to the animal age and is adjustable from -5 to 450 days. Negative values are used to prepare the house before the letting the animals enter the building.

Start Temperature — Set the heater's start temperature for each step.

Curve Status — Select "Yes" to activate the curve. Once it is enabled, the heater's start temperature becomes automatically adjusted between consecutive points of the curve; for this reason the curve steps cannot be modified while the curve is on.

7.2.3. Copy/Paste Heat Curves

1. Select

- » 9. Curve Settings
- » 20. Copy Paste Heater Curve*

* Available if the heaters' Offset curve is enabled (sec. 4.5).

Copy from:	Heater 1
Paste to:	Heater 2

Exit: Press Back Change: Press +/-
Press ▲▼ to select an item

2. Select the heating curve that needs to be duplicated and the target curve as follows:

Copy From — This is the source curve. The one that will be duplicated.

Paste to — This is the target curve. The one on which the copied curve will be pasted.

3. Once the source and the target curves are defined, the message "Confirm?" appears on the display. Select "Yes" to confirm the duplication. The message "Copy in progress... please wait.." is then displayed. Wait until the copying process is over.

7.3. Heat Mats (0-10V Heating Outputs)

The controller has four 0-10V outputs to control supplementary variable fan stages, lights, or heating devices. The following procedure shows how to use 0-10V outputs to control heating units.

This type of output is activated at its minimum intensity when its *Start Temperature* is reached. It increases in intensity as the room temperature decreases and reaches its maximum intensity when the temperature decreases below the *Max. Heat.* temperature. It stops operating when the room temperature increases above the output's *Stop Temperature*.

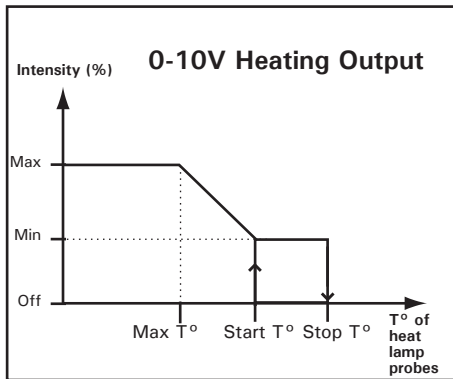

1. Select:

» 21. 0-10V Output Settings

0-10V Output Settings	
Show Settings of	Output 4
Output Type	Heater
Start Temperature	80.0 °F
Stop Temperature	80.5 °F
Bandwidth	3.0 °F
Minimum	15 %
Maximum	100 %
Mode	0-10V

Exit: Press Back Change: Press +/-
Press ▲▼ to select an item

2. Set the following parameters:

Show Settings of — Select the proper 0-10V output. Note that the first 0-10V output is automatically reserved to activate additional lights if light programs are enabled.

Output Type — Choose “Heater” to use the 0-10V output to operate an heating device.

Start temperature — Set the temperature at which the 0-10V output starts operating continuously at its minimum speed. It can be adjusted of +/- 40°F (22.2°C) from the set point.

Stop Temperature — Select the temperature at which the output stops. It can be adjusted from 0.5°F (0.3°C) above the start temperature to 40°F (22.2°C).

Mode — Select the type of signal used by the output (0-10V or 10-0V).

8. LIGHTS

8.1. Principle of Operation

LIGHT PROGRAMS :

The controller has 8 daily light programs to control the light intensity on a daily basis. Each program is composed of up to 30 steps to vary the light intensity in the day and their activation is related to the animal age.

The following graph illustrates a 4-step light program.

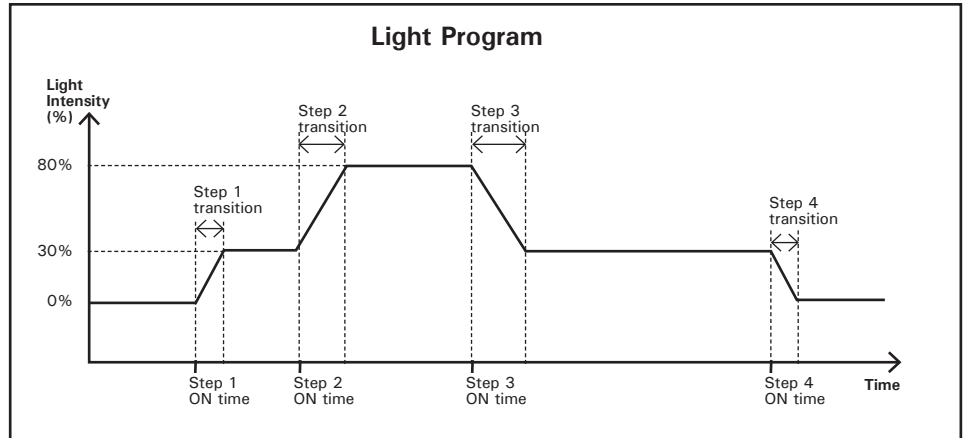

8.2. Activating Additional 0-10V Light Outputs

The controller has four 0-10V outputs to control supplementary variable fan stages, lights, or heating devices. If light programs are enabled, the controller automatically reserves the first 0-10V output to control additional lights.

The lights that are connected to 0-10V outputs follow the same variation as the ongoing light program.

1. Select:

- » 21. 0-10V Output Settings*

*Accessible if 0-10V outputs are enabled (sec. 4.5).

0-10V Output Settings	
Show Settings of	Output 3
Output Type	Light
Mode	0-10V

2. Set the following parameters:

Show Settings of — Select the proper 0-10V output. Note that the first 0-10V output is automatically reserved to activate additional lights if light programs are enabled.

Output Type — Select "Light" if lights are connected to the selected 0-10V output. *0-10V outputs can only control lights if light programs are enabled (sec. 4.5).

Mode — Select the type of signal that is used by the selected output: 0-10V or 10-0V.

8.3. Light Program Settings

1. Select:

- » 15. Light Settings*
- » x. Program x

* This menu is accessible if light programs are enabled (sec. 4.5).

2. Set the following parameters:

Animal Age — This age is the day at which the selected light program starts being used.

Lights on 24 Hours — When this function is enabled, lights always stay lit while the program is running.

Number of Steps — Select the number of steps performed within the selected program. *This parameter is available if the "Lights on 24 Hours" function is disabled above.

Settings for Step #x — Select the proper step then set the following parameters: *This parameter is available if the "Lights on 24 Hours" function is disabled above.

Start Time — Select the time at which the selected step starts.

Intensity — Select the intensity that is reached during the selected step.

Transition — Select the time frame that is required for the lights to reach the specified light intensity.

Light Settings Program x	
Animal Age	1 days
Lights on 24 hours?	No
Number of Steps	2
Display Settings	Step 01
Start Time	6:00A
Intensity	50 %
Transition	0:30 (h:m)
Exit: Press Back Change: Press +/-	
Press ▲▼ to select an item	

9. CLOCK OUTPUTS

The controller has 8 outputs to control various devices using the real-time clock.

Notes:

To run a clock output continuously, set all of its start and stop times to 12:00AM.

! *An alarm sets off if a clock program is not set properly; i.e., if an activated program does not have any start time. This usually occurs when the start and stop times of a program are all set to the same value (other than 12:00AM). When this happens, the controller keeps using the previous clock program until the defective program is corrected.*

👉 Refer to section 4.5 to:

- enable clock outputs;
- enable clock programs;
- select the proper time increment for adjusting start/run/stop times;
- select the proper operating mode for clock outputs 5-8.

CLOCK OUTPUTS 1 TO 4 :

Clock outputs 1-4 can use up to 4 programs each. Each of the 4 programs is composed of 10 start and stop times and the program selection is made as a function of the animal age. Note that program 1 automatically comes into effect once it is programmed.

Clock Output 1			
PROG.1	PROG.2	PROG.3	PROG.4
ON/OFF 1	ON/OFF 1	ON/OFF 1	ON/OFF 1
ON/OFF 2	ON/OFF 2	ON/OFF 2	ON/OFF 2
ON/OFF 3	ON/OFF 3	ON/OFF 3	ON/OFF 3
ON/OFF 4	ON/OFF 4	ON/OFF 4	ON/OFF 4
ON/OFF 5	ON/OFF 5	ON/OFF 5	ON/OFF 5
ON/OFF 6	ON/OFF 6	ON/OFF 6	ON/OFF 6
ON/OFF 7	ON/OFF 7	ON/OFF 7	ON/OFF 7
ON/OFF 8	ON/OFF 8	ON/OFF 8	ON/OFF 8
ON/OFF 9	ON/OFF 9	ON/OFF 9	ON/OFF 9
ON/OFF 10	ON/OFF 10	ON/OFF 10	ON/OFF 10

Clock Output 2			
PROG.1	PROG.2	PROG.3	PROG.4
ON/OFF 1	ON/OFF 1	ON/OFF 1	ON/OFF 1
ON/OFF 2	ON/OFF 2	ON/OFF 2	ON/OFF 2
ON/OFF 3	ON/OFF 3	ON/OFF 3	ON/OFF 3
ON/OFF 4	ON/OFF 4	ON/OFF 4	ON/OFF 4
ON/OFF 5	ON/OFF 5	ON/OFF 5	ON/OFF 5
ON/OFF 6	ON/OFF 6	ON/OFF 6	ON/OFF 6
ON/OFF 7	ON/OFF 7	ON/OFF 7	ON/OFF 7
ON/OFF 8	ON/OFF 8	ON/OFF 8	ON/OFF 8
ON/OFF 9	ON/OFF 9	ON/OFF 9	ON/OFF 9
ON/OFF 10	ON/OFF 10	ON/OFF 10	ON/OFF 10

Clock Output 3			
PROG.1	PROG.2	PROG.3	PROG.4
ON/OFF 1	ON/OFF 1	ON/OFF 1	ON/OFF 1
ON/OFF 2	ON/OFF 2	ON/OFF 2	ON/OFF 2
ON/OFF 3	ON/OFF 3	ON/OFF 3	ON/OFF 3
ON/OFF 4	ON/OFF 4	ON/OFF 4	ON/OFF 4
ON/OFF 5	ON/OFF 5	ON/OFF 5	ON/OFF 5
ON/OFF 6	ON/OFF 6	ON/OFF 6	ON/OFF 6
ON/OFF 7	ON/OFF 7	ON/OFF 7	ON/OFF 7
ON/OFF 8	ON/OFF 8	ON/OFF 8	ON/OFF 8
ON/OFF 9	ON/OFF 9	ON/OFF 9	ON/OFF 9
ON/OFF 10	ON/OFF 10	ON/OFF 10	ON/OFF 10

Clock Output 4			
PROG.1	PROG.2	PROG.3	PROG.4
ON/OFF 1	ON/OFF 1	ON/OFF 1	ON/OFF 1
ON/OFF 2	ON/OFF 2	ON/OFF 2	ON/OFF 2
ON/OFF 3	ON/OFF 3	ON/OFF 3	ON/OFF 3
ON/OFF 4	ON/OFF 4	ON/OFF 4	ON/OFF 4
ON/OFF 5	ON/OFF 5	ON/OFF 5	ON/OFF 5
ON/OFF 6	ON/OFF 6	ON/OFF 6	ON/OFF 6
ON/OFF 7	ON/OFF 7	ON/OFF 7	ON/OFF 7
ON/OFF 8	ON/OFF 8	ON/OFF 8	ON/OFF 8
ON/OFF 9	ON/OFF 9	ON/OFF 9	ON/OFF 9
ON/OFF 10	ON/OFF 10	ON/OFF 10	ON/OFF 10

CLOCK OUTPUTS 5 TO 8

Clock outputs 5 to 8 do not use the programs but they can operate in 3 different ways:

1. Start/Stop mode: With the Start/Stop mode, clock outputs can operate according to 10 different start and stop times.

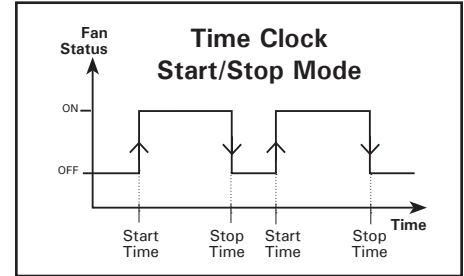

2. Start/Run mode: With the Start/Run mode, clock outputs can operate according to 10 different start and run times.

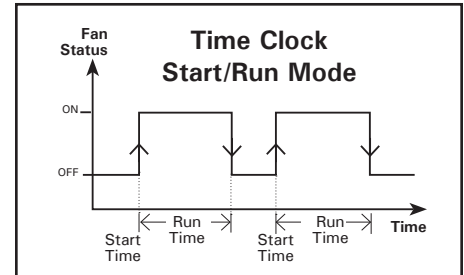

3. Start/Repeat mode: With the Start/Repeat mode, the clock output operates according to a timer which is repeated at regular intervals. This timer is made of a start and run time.

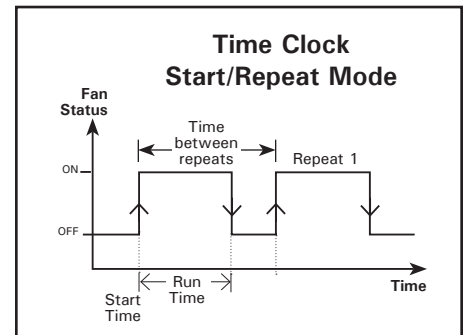

Refer to section 4.5 of this manual to choose the desired operating mode for each clock output.

1. Select:

- » 16. Clock Times*
- » x. Clock x Start/Stop Time

* Available if clock outputs are enabled (sec. 4.5).

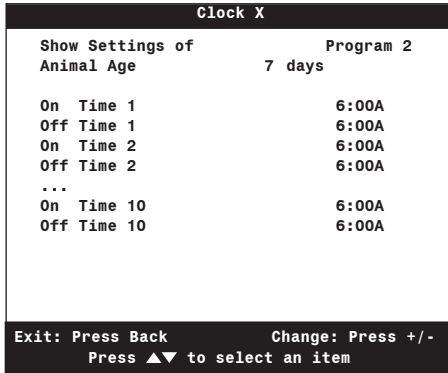

2. Set the following parameters:

Show Settings of — Select a program (for clock outputs 1 to 4 only). The 10 cycles of the selected program are displayed.

Animal Age — Select the age at which the program starts (for clock outputs 1 to 4 only). This menu is not available for program 1 since this program automatically starts once it is programmed (day 0).

On / Off / Run Times — Set the start time and the stop time / or run time of each cycle. If 10 cycles are not required, set the start and stop times of unused cycles to the same value (other than 12:00AM) or set the run time to 0 min and 0 sec.

Number of repeats — If the chosen clock output uses the Start/Repeat operating mode, select how many times the cycle must be repeated over the day. The output starts running at its start time, performs the first cycle and then repeats it as required.

Time between repeats — If the chosen clock output uses the Start/Repeat operating mode, specify the period of time between cycles (this period of time must include the run time).

Operating Day Settings:

1. Select

- » 16. Clock Times*
- » 9. Day of the Week

* This menu is accessible if clock outputs are enabled (sec. 4.5).



2. Set the following parameters:

Show Settings of — Select a clock output. The operating days of the selected clock output are displayed.

Days — Put a check mark to identify on which day(s) the clock output must be used.

10. RELATIVE HUMIDITY (RH) CONTROL

10.1. Principle of Operation

The controller offers different options to compensate for high/low humidity levels in the room. This section describes the operation of each humidity control method.

10.1.1. RH Comp. on the Min. Ventilation Intensity

The humidity level can be decreased by increasing the fans' running time (or the fan speed) in minimum ventilation. If variable fans are used, their speed increases during the minimum ventilation cycles as the humidity level increases; if On/Off fans are used, their running time increases as the humidity level increases. The added fans' on time (or speed) is fully added when the humidity level exceeds the RH set point by 10%.

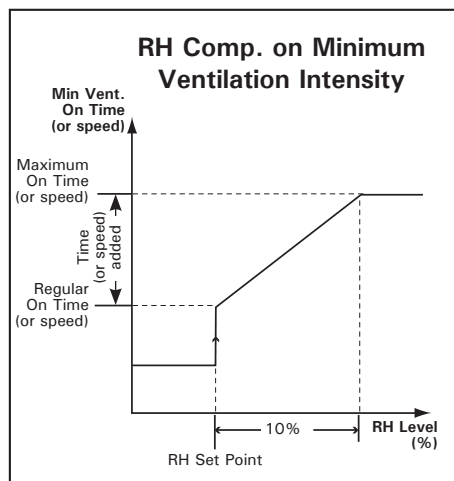

10.1.2. RH Comp. with Heating Outputs

The controller can activate heating units in timer mode to decrease the humidity level. As the humidity level increases, the heaters' On-Time increases proportionally to compensate for the change. They reach their full On-Time when the humidity is at or above RH Set Point + 10% as shown below.

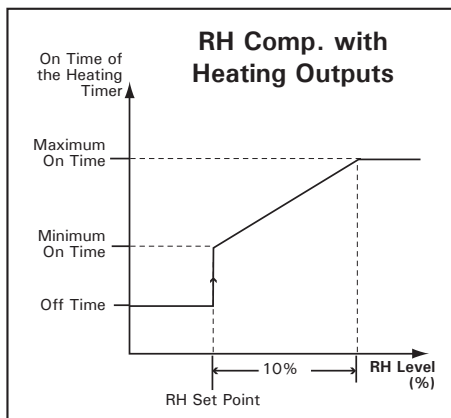

10.1.3. RH Comp. on the Mist Output

The controller can stop mist units when the humidity level is too high. This applies to fan stages with timer-based relays and cooling stages. The mist shutoff occurs when the humidity level increases above the mist shutoff limit.

10.2. Settings

1. Select:

- » 23. Controller Setup
- » 1. Relative Humidity Compensation*

* This menu is accessible if the humidity probe is enabled (sec. 4.5).

Relative Humidity Compensation	
Rel. Humidity SetPoint	65 %
Use Minimum Vent. Comp?	Yes
Add On Time	60 sec
Add Speed	30 %
Use Mist Shut Off?	Yes
Stop Misting at	90 %
Use Heater Compensation?	Yes
Heater Min. On Time	15 sec
Heater Max. On Time	45 sec
Heater Off Time	285 sec
Exit: Press Back Change: Press +/-	
Press ▲▼ to select an item	

2. Set the following parameters:

Relative Humidity Set Point — This is the humidity level above which the compensation starts. This parameter ranges from 25 to 99%. Increase the value to "Off" to disable all humidity compensation functions.

Use Minimum Ventilation Compensation — Select "Yes" to compensate high humidity levels with the fans' run time or speed in minimum ventilation.

Added Speed — Speed that is added to the variable fans' during the minimum ventilation cycles. This parameter ranges from 1 to 100%. Select "Off" to deactivate this function. *This parameter is available if variable outputs are enabled (sec. 4.5).

Added On Time — Time that is added to the fans' run time during the minimum ventilation cycles. This parameter ranges from 0 to 900 seconds. *This parameter is available if the variable outputs are disabled (sec. 4.5).

Use Mist Shut Off? — Select "Yes" to disable mist units (fan stages' timer-based relays & cooling outputs) when the humidity level is too high.

Stop Misting at — Set the humidity level above which the stages' timer-based relays and cooling stages stop. This parameter ranges from 25% to 99%. Increase the value to "Off" if you want to disable this function.

Use Heater Compensation? — Select "Yes" to activate heating units in timer mode when the humidity level is too high.

Min / Max On Time — Set the minimum and maximum run times of the heaters' timer. This parameter ranges from 0 to 900 seconds.

Off Time — Set the off time of the heating cycle. This parameter ranges from 0 to 900 seconds.

11. ALARMS

11.1. Alarm Log

When an alarm occurs, the alarm LED is turned on and the alarm is stored in the alarm log menu, along with the time and date. The controller keeps in memory the last 25 alarm conditions.

1. Select:

- » 20. Alarm Log – or press the Alarm Log shortcut key

Alarm Log	
Logged on:	Jan 01 2010 6:03P
Temperature	Low °F
Probe #x Defective Static Pressure Probe Defective Relative Humidity Probe Defective etc.	
Exit: Press Back	

2. Use the arrow keys to select an alarm. The date and the time at which the selected alarm condition occurred are displayed at the top of the display.

11.2. Alarm Conditions & Settings

The following sections describe how the alarms are set off and how to adjust the alarm limits. Refer to the table below to see all possible alarm conditions.

Alarm Conditions
Low Temp Alarm
High Temp Alarm
Low Pressure Alarm
High Pressure Alarm
Var. Module comm
Inlet communication
Relay communication
Relay Programming Fault
Clock 1-4 fault, Program #"x"
Probe #x Defective
Outside Probe Defective
Relative Humidity probe Defective
Static Pressure Probe Defective
Water Spill
Water Module Com
Feeder run time
Power Failure

Zero crossing pop-up screen: This alarm message is displayed when there is instability in the controller power supply:

- Make sure power supply is good.
- Make sure the flat cable is connected properly between the top and bottom boards inside the controller.
- Make sure both power cables are connected properly inside the controller (main power cord and power cable between main circuit board and upper circuit board).

Another alarm situation occurs when power to the controller fails. In this case, the alarm relay is activated. When the alarm relay is activated, the normally open contact (—●—) closes.

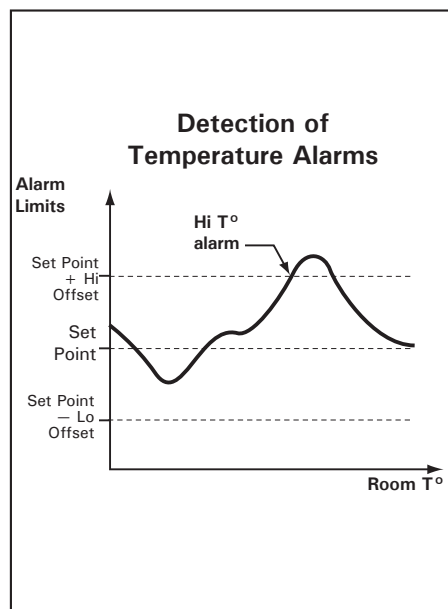

11.2.1. Temperature Alarms

The following diagrams explain how temperature alarms are detected:

When the average room temperature exceeds the high temperature alarm setting (Set Point + Hi Offset), a high temperature alarm sets off. When the average room temperature decreases below the low temperature alarm limit (Set Point - Lo Offset), a low temperature alarm sets off.

The critical temperature is the absolute maximum allowable temperature in the room.

Outside Temperature Influence on Alarms:

This feature avoids false alarms due to warm weather: the room temperature can exceed the Hi temperature limit in the case where the outside temperature is warm enough. The room temperature must remain equal or lower than $\text{Outside } T^{\circ} + \text{Outside Influence}$ or lower than the Set Point + Hi Offset, whichever is higher but in every case, it must remain below the critical temperature, no matter what the outside temperature is.

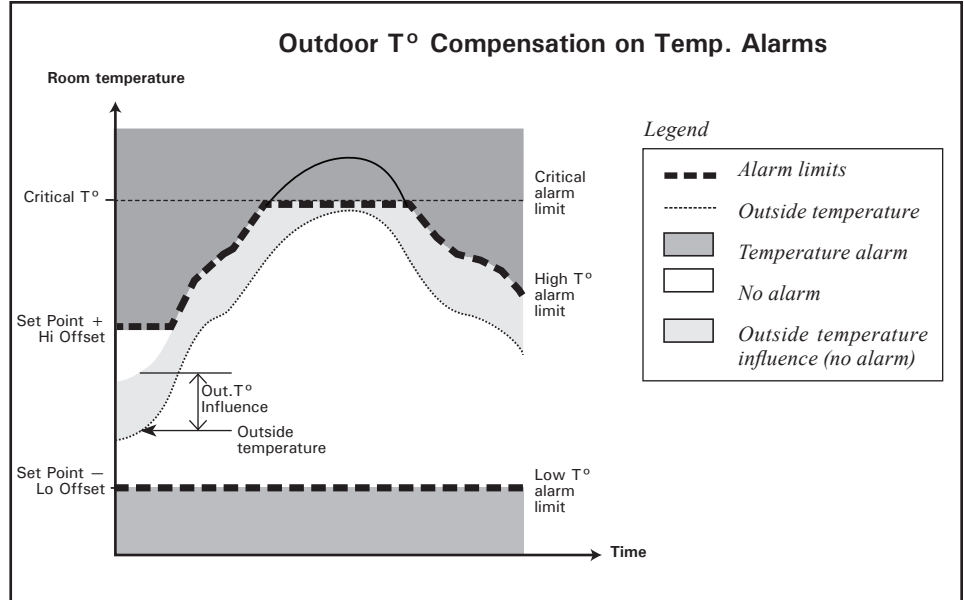

1. Select:

- » 23. Controller Setup
- » 5. Alarm Settings
- » 1. Temperature

2. Set the following parameters:

Temperature Alarm Settings	
Low Offset Temperature	10.0 °F
High Offset Temperature	15.0 °F
Outside Influence	5.0 °F
Critical Temperature	90.0 °F
High Breaker Alarm	120.0 °F

Low High Temperature Offset — The Hi and low offsets are the number of degrees below and above the set point at which a temperature alarm sets off. The low temperature limit ranges from 20°F to 0.5°F (11.1 to 0.3°C) below the set point (Lo Offset). The high temperature limit ranges from 0.5°F to 35°F (0.3 to 19.4°C) above the set point (Hi Offset).

Outside Influence — The outside temperature influence is the number of degrees that are added to the outside temperature to avoid false alarms on warm days. Refer to the previous diagram.

Critical Temperature — The critical temperature is the absolute maximum temperature that is allowed in the room.

High Breaker Alarm — If the temperature of the main breaker is monitored by a probe, set the probe temperature over which a breaker temperature alarm must sound. **Accessible if the breaker's monitoring function is enabled in section 4.5.*



Install the breaker's probe close to the breaker box, not inside the box!

11.2.2. Static Pressure Alarms

The controller can generate an alarm if the static pressure decreases below the low pressure limit or if it exceeds the high pressure limit. The alarm condition must be maintained during a user-defined delay before the alarm sets off.

Lo Static Pressure Alarm:

You can assign a relay that will be activated if a Low Static Pressure Alarm occurs. This relay may be used to activate a fan for instance. When a low static pressure alarm occurs, this relay turns on for a 15 minutes. If the static pressure level is still below the Low Pressure Limit after this delay has elapsed, the relay keeps running for another 15 minutes, up until the pressure level returns in the normal range.

Low Static Pressure Alarm Curve

The controller can automatically change the low static pressure alarm limit with time. With the low SP alarm curve, you can program 3 different low pressure alarm limits and the moment at which each limit starts being used is defined as a function of the animal age. Refer to the installation setup section of this manual to enable the Low SP Curve (section 4.5).

Hi Static Pressure Alarm:

When a high static pressure alarm occurs, the controller can open vent doors and the tunnel curtain. The curtain or vent doors open during a user-defined delay (Open-Time) and then stay still for 15 minutes (this time includes the Open-Time). If the pressure level still exceeds the Hi Static Pressure Limit after 15 minutes, the same cycle starts over again, up until the pressure level goes back in the normal range.

11.2.2.1. SP Alarm Settings:

1. Select:

- » 23. Controller Setup
- » 5. Alarm Settings
- » 2. Static Pressure*
- » 1. Low and High Limits

** This menu is accessible if the static pressure sensor is enabled (sec. 4.5).*

Static Pressure Lo and Hi Alarm Limits	
Low Alarm	.10 "WC
High Alarm	.150 "WC
Low Delay	600 sec
High Delay	300 sec
or	
Low SP limit 1 :	.02 "WC
Low SP limit 2 :	.02 "WC
Animal Age 2 :	20 days
Low SP limit 3 :	.02 "WC
Animal Age 3 :	40 days
High Alarm	.150 "WC
Low Delay	600 sec
High Delay	300 sec

2. Set the following parameters:

Low /High Pressure Alarm — Set pressure limits to the desired values (from 0.00 to 0.40"WC) or select "Off to disable the low pressure alarm. If the Low SP alarm curve is used, set all 3 low pressure alarm limits. **Low SP limits 2-3 are only accessible if the Low SP alarm curve is enabled in the Installation Setup (sec. 4.5).*

Animal Age — If the Low SP alarm curve is used, set the animal age at which each low pressure alarm limit starts being used (note that the first alarm limit is used when the animals are younger than the age specified for alarm limit 2. **Accessible if the Low SP alarm curve is enabled in the Installation Setup (sec. 4.5).*

Low/High Delay — Set the delay over which the alarm condition must be maintained for an alarm to set off. Set this delay separately for the Hi and Lo static pressure alarms.

11.2.2.2. Low SP Alarm Relay

1. Select:

- » 23. Controller Setup
- » 5. Alarm Settings
- » 2. Static Pressure*
- » 2. Low Alarm Relay

** This menu is accessible if the static pressure sensor is enabled (sec. 4.5).*

Low Static Pressure Alarm Relay							
1	2	3	4	5	6	7	8
---	---	---	---	---	---	---	---
9	10	11	12	13	14	15	16
---	---	---	---	---	---	---	---
17	18	19	20	21	22	23	24
---	---	---	---	---	---	---	---

2. Put a check mark to identify the relay that is used in case of a low pressure alarm.

11.2.2.3. Hi Static Pressure Alarm Settings

1. Select:

- » 23. Controller Setup
- » 5. Alarm Settings
- » 2. Static Pressure*
- » 3. High Alarm

** This menu is accessible if the static pressure sensor is enabled (sec. 4.5).*

Hi Static Pressure Alarm Settings	
Open Vent Door	30 sec

2. Select the moving time of the curtain and/or vent doors* when a static pressure alarm occurs. The curtain or vent door opens or closes during this delay every 15 minutes, up until the static pressure returns in the normal range. **For static pressure-based vent doors and curtain only.*

11.2.3. Water Spill Alarms

A water spill alarm sets off when the water consumption exceeds a certain limit. This limit can be adjusted from 0 to 10,000 gallons or liters per 15 minutes. The alarm is activated if a greater amount of water is detected within the 15 minute interval.

1. Select:

- » 23. Controller Setup
- » 5. Alarm Settings
- » 3. Water Consumption*

* This menu is accessible if water meters are enabled (sec. 4.5).

Water Spill Alarm Settings	
Water Meter 1	10 gal
Water Meter 2	10 gal
Water Meter 3	10 gal
Water Meter 4	10 gal
Water Meter 5	10 gal
Water Meter 6	10 gal
Water Meter 7	10 gal
Water Meter 8	10 gal
Water Meter 9	10 gal
Water Meter 10	10 gal

Exit: Press Back Change: Press +/-
Press ▲▼ to select an item

2. Set each the maximum water consumption per period of 15 minutes of each water meter.

11.2.4. Feeder Alarms

An alarm sets off when the continuous feeder run time is too high. When this type of alarm occurs, the alarm relay switches and the controller opens the feeder relay to stop the feeder motor.

1. Select:

- » 23. Controller Setup
- » 5. Alarm Settings
- » 4. Feeder

Feeder Alarm Settings	
Maximum Run Time	1:30(h:m)

2. Set the following parameters:

Maximum Run Time — Set the maximum consecutive run time of the feeder motor. This parameter ranges from 0:00 to 23:59 h:m.

Stop at Max Run Time? — Select “Yes” to stop the feeder when a feeder run time alarm occurs (the feeder relay opens).

Restart Feeder — If a feeder alarm is currently active, the message “Restart Feeder” is displayed. Select “Yes” to reset the feeder alarm and to restart the feeder.

12. MONITORING FUNCTIONS

12.1. Current Conditions

The current condition menus give a quick view of the actual conditions in the barn:

1. Select:

» **1. Current Conditions**

2. Select the desired condition menu:

1. Current Condition — To see the current probe temperature reading and other useful pieces of information. The controller automatically selects this menu after 4 minutes of inactivity.

Current Condition	
Current Temp. Set Point	80.0 °F
Animal Age	5 days
Static Pressure	.02 "WC
Minimum Vent. On Time	0:30 (m:s)
Light Intensity	80 %
Vent Door Opening	10 %
Vent Door 2 Opening	0 %
Inside Temp. Probe 1 (...)	77.8 °F
Inside Temp. Probe 8	78.0 °F
Relative Humidity	30 %
Average House Temperature	79.0 °F
Outside Temperature	58.0 °F

Exit: Press Back
Press ▲▼ to select an item

2. Active Sensors — To see what temperature sensors are currently used to measure the average room temperature.

3. Current Active Relays — To see which relays are currently active. Select "All" to view all active relays; select "Fan/Cool" to see the relays of fan and cooling stages only

Current Active Relays							
Show Active Relays :All (or Fan/Cool)							
1	2	3	4	5	6	7	8
---	---	---	---	---	---	---	---
9	10	11	12	13	14	15	16
---	---	---	---	---	---	---	---
17	18	19	20	21	22	23	24
---	---	---	---	---	---	---	---

12.2. History

The input readings are logged in the history menus at midnight every day. These histories are reset when a new batch starts.

AVERAGE HOUSE T°: The daily minimum and maximum readings of the average room temperature are displayed for the past 75 days.

1. Select

» **2. Average House Temperature**

Average House Temperature 75 days			
Temperature		77.9 °F	
Date	Minimum	Maximum	
Dec 19 2010	9:05A 76.0	12:34A	78.2
Dec 18 2010	4:19A 75.4	9:58A	79.3
Dec 17 2010	1:28A 74.0	10:34P	80.1
Dec 16 2010	12:21P 74.5	2:12P	78.2
Dec 15 2010	8:34A 75.3	12:14A	79.3
Dec 14 2010	1:14A 74.1	6:32P	78.2
Dec 13 2010	4:52A 76.3	3:28P	78.7
Dec 12 2010	11:39P 76.2	5:33P	79.2

INDIVIDUAL PROBE TEMPERATURE: The daily minimum and maximum temperature readings of each individual probe are displayed for the past 7 days.

1. Select

» **3. Individual Probe Temperature**

Individual Probe Temperature (7 days)			
Display	Probe 1		
Temperature	77.0 °F		
Date	Minimum	Maximum	
Dec 19 2010	9:05A 76.0	12:34A	78.2
Dec 18 2010	4:19A 75.4	9:58A	79.3
Dec 17 2010	1:28A 74.0	10:34P	80.1
Dec 16 2010	12:21P 74.5	2:12P	78.2
Dec 15 2010	8:34A 75.3	12:14A	79.3
Dec 14 2010	1:14A 74.1	6:32P	78.2
Dec 13 2010	4:52A 76.3	3:28P	78.7
Dec 12 2010	11:39P 76.2	5:33P	79.2

OUTSIDE TEMPERATURE: The daily minimum and maximum readings of the outside temperature probe are displayed for the past 75 days.

1. Select

» **4. Outside Temperature***

* This menu is accessible if the outside T° sensor is enabled (sec. 4.5).

Outside Temperature (75 days)			
Temperature		68.4 °F	
Date	Minimum	Maximum	
Dec 19 2010	9:05A 66.0	12:34A	68.2
Dec 18 2010	4:19A 65.4	9:58A	69.3
Dec 17 2010	1:28A 64.0	10:34P	60.1
Dec 16 2010	12:21P 64.5	2:12P	68.2
Dec 15 2010	8:34A 65.3	12:14A	69.3
Dec 14 2010	1:14A 64.1	6:32P	68.2
Dec 13 2010	4:52A 66.3	3:28P	68.7
Dec 12 2010	11:39P 66.2	5:33P	69.2

RELATIVE HUMIDITY: The daily minimum and maximum readings of the humidity probe are displayed for the past 75 days.

1. Select

» **5. Relative Humidity***

* This menu is accessible if a humidity sensor is enabled (sec. 4.5).

WATER CONSUMPTION: The daily water consumption of each water meter is displayed for the past 60 days. The total consumption is displayed as well.

1. Select

» **18. Water Consumption***

» **Select the desired water meter**

* This menu is accessible if water meters are enabled (sec. 4.5).

Water Consumption of Meter X (60 days)	
Total	15 lit
Today	5 lit
March 31 2010	4 lit
March 30 2010	5 lit
March 29 2010	6 lit

Exit: Press Back
Press ▲▼ to select an item

HEATER RUN TIME: The daily run times of each heating outputs are displayed for the past 7 days. The total run time is displayed as well.

1. Select
 - » 19. Heater Run Time
 - » Select the desired heating stage

Heater X Run Time (7 days)	
Total Today	1000 min 600 min
March 31 2010	600 min
March 30 2010	450 min
March 29 2010	550 min

Exit: Press Back
Press ▲▼ to select an item

12.3. Monitoring the Animal Age & Number

Animal Age: The controller uses the animal age as a reference to find its position in the various curves (minimum ventilation and set point curves). It also uses this age to activate the proper light program and to limit the tunnel ventilation level. Using the animal age is optional, refer to section 4.5 to enable or disable animal age functions.

Number of animals: At the beginning of a batch, you must specify what is the initial number of animals in the room. You must then post up every variation in the number of animals (mortalities & culled animals). This way, the controllers keeps track of the number of remaining and dead animal within a batch.

 **ALL histories are reset when a new batch starts.**

1. Select:
 - » 17. Animal Age & Mortality

Animal Age & Mortality	
Animal Age	5 days
Initial Count	0
New Mortality	0
Total Mortality	0
Remaining Count	0
Start New Batch	No

Exit: Press Back Change: Press +/-
Press ▲▼ to select an item

2. Set the following parameters:

Animal Age — This parameter ranges from -5 to 450 days. Negative day values are used to prepare the house before the animals' arrival.
*This parameter is available if the animal age function is enabled in section 4.5.

Initial Count — Enter the initial number of animals at the beginning of the batch.

New Mortality — Post up the mortalities as they occur. Once you have entered a value, the controller validates it and displays "0" afterwards. The controller then adds this value to the total number of mortalities and removes it from the remaining animal count.

Total Mortality — This is the total number of mortalities since the beginning of the batch. This value is displayed as a reading and cannot be modified.

Remaining Count — This is the total number of animals remaining in the house. Initial Count - Total Mortality.

Start New Batch — When a new batch starts the controller resets all histories. The remaining count goes back to the initial count and the total number of mortalities goes back to zero. Once you have answered "Yes" to the Start New Batch question, the controller validates the answer then displays "No" again meaning the new batch has just started.

12.4. Message Center

Use the message center as a reminder for the maintenance of your equipment. You must first enter the frequency at which your various servicing activities must be performed. The controller will then advise you when the servicing time has elapsed. When this happens, the controller turns on the Message Center status LED and posts a message telling the nature of the servicing activity that needs to be executed in the Message Center menu.

12.4.1. Message Log

The Message Log menu tells which servicing activity need to be done. When the Message Center status LED is lit when a message is present in the Message Log menu. The controller keeps in memory the last 25 events.

1. Select:

- » 24. Message Center
- » 1. Message Log – or press “F”.

Message Log	
Logged on:	Jan 01 2010 6:03P
Temperature	Low °F
Adjust Override Thermostats	
Check Ctrl Alarm output	
Exit: Press Back	

12.4.2. Clearing the Message Log

Once you have completed the servicing activities, clear the message logs as follows:

1. Select:

- » 24. Message Center
- » 3. Clear Message Center

2. Select “Yes” to clear the messages that are currently present in the Message Log menu.

Clear Message Center	
Do you really want to clear all the messages recorded?	No

12.4.3. Servicing Schedule

Specify the frequency at which your servicing activities must be performed :

1. Select:

- » 24. Message Center
- » 2. Message Settings

Message Center Settings	
External Input	500 hours
Adj. Override Thermostats	7 days
Check Ctrl Alarm Output	3 month

2. Set the following parameters:

 *To disable a monitoring function, decrease the parameter until the word “Off” appears.*

External Input — Select after how many hours of operation the external input must be checked.

Adjust Override Thermostats / Check Control Alarm Output — Set the frequency at which both of these maintenance activities must be performed. The countdown starts from the moment the controller is powered up.

12.4.4. Relay Run Time

The controller keeps in memory the running time of the first 50 relays (relays 1-50). Follow this procedure to see the relays’ run times.

1. Select:

- » 25. Relay Run Time
- » 2. Show Relay Run Time

Show Relay Run Time	
Relay #1:	1250 hours
Relay #2:	14750 hours
Relay #3:	1550 hours
Relay #4:	540 hours
Relay #5:	15673 hours
Relay #6:	9920 hours
Relay #7:	820 hours
Relay #8:	4580 hours
Relay #9:	7821 hours
Relay #10:	0 hours
Relay #11:	0 hours
Exit: Press Back	

Clearing the Relay Run Time: Follow this procedure to clear the run time of a specific relay (amongst relay 1 to relay 50).

1. Select:

- » 25. Relay Run Time
- » 1. Clear Relay Run Time

2. Put a check mark to clear the run time history of a relay then answer “Yes” to the “Clear Run Time” question.

Clear Relay Run Time of selected Relay							
Clear Run Time : No							
1	2	3	4	5	6	7	8
---	---	---	---	---	---	---	---
9	10	11	12	13	14	15	16
---	---	---	---	---	---	---	---
17	18	19	20	21	22	23	24
---	---	---	---	---	---	---	---

13. TECHNICAL SPECIFICATIONS

Type.....	CC24-7 ELITE
Main supply fuse F25.....	 1A, fast-blow
Main supply/frequency	120/240 Vac, 50/60Hz
0-10V outputs #1-4	0-10Vdc, 30mA source max.
Precision on 0-10V outputs	±1 %
14Vdc Outputs	14 Vdc ± 10%, regulated, 250mA max.
Alarm Contact.....	ON/OFF output, 24VDC or AC, 0.15A.
Enclosure.....	ABS, moisture and dust-tight.
Operating temperature	32 to 104°F (0 to 40°C). Indoor use only.
Storage temperature	5 to 122°F (-15 to 50°C)
Ambient relative humidity.....	max. 95%
Relative humidity input	4-20mA
Pressure input	4-20mA
Temperature inputs.....	1K @ 77°F (25°C), NTC

14. TRANSFER MENU

14.1. Screen Contrast

1. Simultaneously press and hold the right and left arrow keys for 5 seconds to display the transfer menu.

2. Choose **6. Contrast** and press Enter.

3. Set the screen contrast to the desired intensity then press Enter to validate.

4. Simultaneously press and hold the right and left arrow keys for 5 seconds to exit from the transfer menu.

14.2. Communication Speed

1. Simultaneously press and hold the right and left arrow keys for 5 seconds to display the transfer menu.

2. Choose **5. Comm Speed** and press Enter.

3. Set the communication speed to the desired value: select the high speed mode if the controller uses the A-BOX communication system or select the low speed if it uses AGNET.

4. Simultaneously press and hold the right and left arrow keys for 5 seconds to exit from the transfer menu.

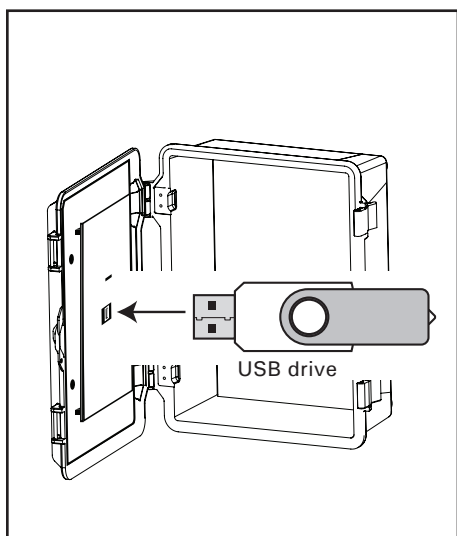

14.3. Update/Backup Process

The USB drive allows upgrading the firmware or software of your controller. It can also be used to make a backup of your controller settings or to copy these settings on another controller of the same type.

 **Turn off power each time you open the controller's enclosure. This prevents accidental exposure to areas of high voltage.**

1. Turn off power to the controller.

2. Lift the latches to open the front door of the controller.

3. Insert the USB drive in the connector behind the front door.

4. Close the front cover and reapply power to the controller.

5. Simultaneously press and hold the right and left arrow keys for 5 seconds to display the transfer menu.

6. Select the desired option:

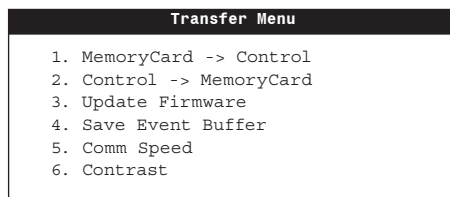

1. MemoryCard -> Control

Choose **1. MemoryCard -> Control** to load a new configuration file into your controller. This transfer will update your controller's software and parameter settings.

When selecting this option, a list of all configuration files located on the card is displayed (*.DMP files). Select the desired file and then simultaneously press the up and down-arrow keys to start the transfer.

 **Note that the controller can only read the files that are located at the root of the USB drive. It cannot access any sub-directory!**

2. Control -> MemoryCard

Choose **2. Control -> MemoryCard** to save your controller settings on the USB drive and press Enter. The saving process will start as soon as you enter this menu.

The controller will create a new SAVE~1.DMP file at the root of the USB drive. If this file name already exists, it will be saved under a different name ("SAVE~2.DMP" for instance). This way, the controller will never erase a file on the card.

3. Update Firmware

Choose **3. Update Firmware** to download a new firmware file into your controller. This process will not affect your parameter settings.

When selecting this option, a list of all firmware files located on the USB drive is displayed (*.PKG files). Select the desired file and then simultaneously press the up and down-arrow keys to start the transfer.

 **Note that the controller can only read the files that are located at the root of the USB drive. It cannot access any sub-directory!**

4. Save Event Buffer

Choose **4. Save Event Buffer** to save the event buffer of the controller on your USB card. The file will have a *.txt extension. (USB card only!)

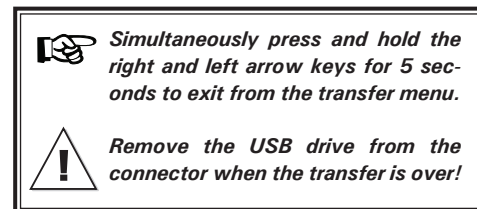

15. INSTALLATION REPORT

CLIENT

Name: _____

Address: _____

City: _____

Phone: _____

Fax: _____

INSTALLER

Name: _____

Address: _____

City: _____

Phone: _____

Fax: _____

CC24-7 ELITE

Installation Setup Worksheet (sec. 4.5).

Parameter	Range	Your settings
Clear Alarms	Yes / No	
Number of T° Probes	1 to 8	
Number of Water Meters	0 to 10	
Number of Relays	10 to 100	
Number of Inlets	0 to 10	
Number of Fan Stages	1 to 16	
Number of Cooling	0 to 4	
Number of Programs	None / ab / abc / abcd	
Number of Light Programs	0 to 8	
Number of Heaters	0 to 8	
Number of Natural Zones	0 to 4	
Number of Clocks	0 to 8	
# of Programs - Clock Output 1	1 to 4	
# of Programs - Clock Output 2	1 to 4	
# of Programs - Clock Output 3	1 to 4	
# of Programs - Clock Output 4	1 to 4	
Clock Output 5 Mode	Start-Stop / Start-Run / Start-Repeat	
Clock Output 6 Mode	Start-Stop / Start-Run / Start-Repeat	
Clock Output 7 Mode	Start-Stop / Start-Run / Start-Repeat	
Clock Output 8 Mode	Start-Stop / Start-Run / Start-Repeat	
Clock Increments	1, 5 or 10 min	
Use Night Set Point ?	Yes / No	
Use Set Point Curve ?	Yes / No	
Use Minimum Ventilation Curve ?	Yes / No	
Use Heater Offset Curve ?	Yes / No	
Use Animal Age function ?	Yes / No	
Use Heater Programs ?	Yes / No	
Use Heater Hi / Lo Fire ?	Yes / No	
Use Tunnel ?	Yes / No	
Tunnel Mode :	Timed / Static Pressure	
Vent Door Transition mode :	Open / Static Pressure / As is	
Tunnel Pre-opening Type	Normal / Tunnel Help	
Tunnel Pre-opening Time	n/a	_____seconds
Multiple tunnel stages with age ?	Yes / No	
Use tunnel curtain in natural ?	Yes / No	
Use Stir Fans ?	Yes / No	
Use Variables ?	Yes / No	
Variable 1 Minimum Speed :	n/a	_____%

... Installation Setup Worksheet (sec. 4.5).

Parameter	Range	Your settings
Variable 2 Minimum Speed :	n/a	_____ %
Use Ramping on Stage 1 ?	Yes / No	
Use Ramping below Set Point ?	Yes / No	
Stage 1 Ramping Delay (advanced)	n/a	_____ seconds
Stage 2 Ramping Delay (advanced)	n/a	_____ seconds
Outside T° Set Point (advanced)	n/a	_____ °
Ramping cycle (advanced)	n/a	_____ seconds
Use Outside Temperature ?	Yes / No	
Use Relative Humidity Probe ?	Yes / No	
Use Static Pressure (SP) Probe ?	Yes / No	
SP Set 2 - Vent Doors	None / Stage / Outside T°	
Vent Doors' Pre-opening Mode	Auto / Manual	
Pre-opening delay for Vent Doors	n/a	_____ seconds
Pre-opening delay for Attic Vents	n/a	_____ seconds
SP Set 2 - Tunnel Curtain	None Stage	
Use SP Compensation on Inlets?	Yes / No	
Send Temperature Compensation each	n/a	___ : ___ (m:s)
Use Curve on Low SP Alarms?	Yes / No	
Monitor breaker temperature ?	Yes / No	
Vent Door Mode	SP / Potentiometer / Timer	
Use 2nd Inlet?	Attic / 2nd inlet	
Attic Mode	SP / Time	
2nd Inlet Type	Sidewall / Tunnel	
2nd Inlet Mode	SP / Time	
Attic/2nd Inlet Probe	Room / Individ.	
Shown on LED Display	Temperature and: - Static pressure -Vent door position	

Probe Assignment Worksheet

OUTPUTS		T° Probes							
		1	2	3	4	5	6	7	8
Avg Room T°	Program a								
	Program b								
	Program c								
	Program d								
Heater 8 Hi	Program a								
	Program b								
	Program c								
	Program d								
Heater 8	Program a								
	Program b								
	Program c								
	Program d								
Heater 7 Hi	Program a								
	Program b								
	Program c								
	Program d								
Heater 7	Program a								
	Program b								
	Program c								
	Program d								
Heater 6 Hi	Program a								
	Program b								
	Program c								
	Program d								
Heater 6	Program a								
	Program b								
	Program c								
	Program d								
Heater 5 Hi	Program a								
	Program b								
	Program c								
	Program d								
Heater 5	Program a								
	Program b								
	Program c								
	Program d								
Heater 4 Hi	Program a								
	Program b								
	Program c								
	Program d								
Heater 4	Program a								
	Program b								
	Program c								
	Program d								
Heater 3 Hi	Program a								
	Program b								
	Program c								
	Program d								

OUTPUTS		T° Probes							
		1	2	3	4	5	6	7	8
Heater 3	Program a								
	Program b								
	Program c								
	Program d								
Heater 2 Hi	Program a								
	Program b								
	Program c								
	Program d								
Heater 2	Program a								
	Program b								
	Program c								
	Program d								
Heater 1 Hi	Program a								
	Program b								
	Program c								
	Program d								
Heater 1	Program a								
	Program b								
	Program c								
	Program d								
Inlet 1									
Inlet 2									
Inlet 3									
Inlet 4									
Inlet 5									
Inlet 6									
Inlet 7									
Inlet 8									
Inlet 9									
Inlet 10									
0-10V Output 1									
0-10V Output 2									
0-10V Output 3									
0-10V Output 4									
Natural Zone 1									
Natural Zone 2									
Natural Zone 3									
Natural Zone 4									
Cooling 1									
Cooling 2									
Cooling 3									
Cooling 4									
Main Breaker T°									
Attic Vent									

CC24-7 ELITE

Relays' Description

1	37	73
2	38	74
3	39	75
4	40	76
5	41	77
6	42	78
7	43	79
8	44	80
9	45	81
10	46	82
11	47	83
12	48	84
13	49	85
14	50	86
15	51	87
16	52	88
17	53	89
18	54	90
19	55	91
20	56	92
21	57	93
22	58	94
23	59	95
24	60	96
25	61	97
26	62	98
27	63	99
28	64	100
29	65	
30	66	
31	67	
32	68	
33	69	
34	70	
35	71	
36	72	

MAIN MENU	SUB-MENUS	MAIN MENU	SUB-MENUS	MAIN MENU	SUB-MENUS
1 Current Conditions	1 Current Conditions 2 Active Sensors 3 Current Active Relays	12 Vent Doors 2 / Static Pressure		20 Alarm Log	
2 Average House Temperature		12 Tunnel Curtain 2		21 0-10V Output Settings	
3 Individual Probe Temperature		13 Heater Start/Stop Temperature		22 Relay and Probe Assignment	1 Relays for Stages 2 Relays for Heaters 3 Relay for Tunnel Curtain 4 Relays for Vent Doors 5 Relays for Attic/2nd inlet 6 Relays for Cloaks 7 Relays for Coolings 8 Relays for Backup 9 Relays for Naturals 10 Relay Timer/Variable Settings 11 Relays for feeder 12 Probes for Stages 13 Probes for Heaters 14 Probes for Coolings 15 Probes for Naturals 16 Probes for Inlets 17 Probes for 0-10V Outputs 18 Probes for the main breaker 19 Probes for Attic/2nd Inlet 20 Copy Paste
4 Outside Temperature		14 Fan/Cool./Nat. Temp. Settings 1 Fan Temperature Settings 2 Cooling Temperature Settings 3 Natural Temperature Settings		23 Controller Setup	1 Relative Humidity Compensation 2 Installation 3 Probe Calibration 4 Time and Date 5 Alarm Settings 6 Day / Night Time 7 Password 8 Units 9 Test Mode 10 Version
5 Relative Humidity		15 Light Settings 1 Program 1 2 Program 2 3 Program 3 4 Program 4		24 Message Center	
6 Program Selection		16 Clock Time 1 Clock 1 2 Clock 2 3 Clock 3 4 Clock 4 5 Clock 5 6 Clock 6 7 Clock 7 8 Clock 8 9 Day of the week		25 Relay Run Time	
7 Temperature Set Point		17 Animal Age & Mortality			
8 Minimum Ventilation		18 Water Consumption 1 Water Meter 1 2 Water Meter 2 ... 10 Water Meter 10			
9 Curve Settings 1 Temperature Set Point 2 Minimum Ventilation (Var./On Time) 3 Minimum Ventilation Variable 2 4 Heater 1 Start Temperature 5 Heater 1 Hi Start Temperature 6 Heater 2 Start Temperature 7 Heater 2 Hi Start Temperature ... 19 Heater 8 Start Temperature 20 Heater 8 Hi Start Temperature		19 Heater Run Time 1 Heater 1 2 Heater 1 Hi 3 Heater 2 4 Heater 2 Hi ... 15 Heater 8 16 Heater 8 Hi			
10 Inlet Comp. / Vent Doors & SP					
11 Tunnel Curtain					
12 Attic Settings					

16. INDEX

A

- Age see Animals
- Alarms
 - Alarm conditions & settings 50
 - Alarm log 50
 - Reset the alarm log 14
 - Clock program alarm 47
 - Critical temperature alarms 51
 - Low SP alarm curve
 - Activation 16
 - Principle of operation 52
 - Settings 52
 - Zero-crossing screen 50
- Animals
 - Animal age functions 14
 - Information 55
 - Multiple tunnel stage with age 15
 - Posting new mortalities 55
 - Starting a new flock 55
- Assignment
 - Probe assignment 17
 - Relay Assignment 18
- Attic vent
 - Activation 16
 - Operation & settings 38–39
 - Pre-opening 16
 - Probe assignment 17
 - Relay assignment 19

B

- Backup
 - Making a backup of the controller 58
- Backup relay box 20
- Birds see Animals
- Breaker
 - Monitoring the breaker's T°
 - Activation 16
 - Hi temperature alarm limit 51
 - Probe assignment 17

C

- Calibration
 - Probe calibration 17
- Celsius units 13
- Clock
 - Display : AM/PM or 24hours 13
 - Setting the time and date 12
- Clock outputs
 - Activation 14
 - Operation & settings 47
 - Relay assignment 20
 - Time increment 14

- Common relays see Relays
- Communication speed 58
- Compensation
 - Humidity comp. see Relative humidity
 - Inlet compensation: based on SP
 - Principle of operation 33
 - Inlet's T° & pressure compensations
 - Activation 16
 - Principle of operation 33
 - Min. ventilation compensation 25
- Conditions 54
- Connections 7
- Contrast 58
- Contrast (LCD screen) 11
- Controller
 - Features 5
 - Installation setup 14–16
 - Location of the controls 11
 - Mounting instructions 7
 - Program version 21
 - Technical specifications 57
- Cooling outputs (mists)
 - Activation 14
 - Principle of operation 40
 - Probe assignment 17
 - Relay assignment 20
 - Settings 40
 - Shutoff on hi humidity levels 49
- Copy & Paste function
 - Controller programs 13
 - Fan stages' relays 19
 - Heaters' curves 44
- Current conditions 54
- Curtains
 - see Tunnel or Natural Ventilation
- Curves
 - Heaters' offset curve
 - Activation 14
 - Copy & Paste 44
 - Principle of operation 44
 - Settings 44
 - Minimum ventilation - On Time curve
 - Activation 14
 - Principle of operation 24
 - Minimum ventilation - Speed curve
 - Activation 14
 - Principle of operation 24
 - Settings 24
 - Set point curve
 - Principle of operation 22

D

- Date. See Time
- Day / Night

- Day/night times 12
- Night set point
 - Activation 14
 - Principle of operation 22

Display

- Red led display
 - Location 11
 - Unit selection 16
- Status leds 11

E

- Electrical specifications 57
- External input 56

F

- Fahrenheit units 13
- Fan stages
 - 0-10V ventilation
 - Principle of operation 27
 - Probe selection 17
 - Settings 28
 - Activation 14
 - Min. Vent. see Minimum ventilation
 - Optional ventilation stages see 0-10V
 - Principle of operation 26
 - Probe assignment 17
 - Relay assignment 18
 - Settings 27
 - Stir fans see Stir fans
 - Timer-based relays
 - Activation 18
 - Principle of operation 18, 26
 - Settings 19
 - Transition between stages 1 and 2
 - Principle of operation 26
 - Settings 27
 - Variable fans
 - Activation 15, 19
 - Minimum fan speed 15
 - Principle of operation 26

Feeder

- Alarm settings 53
- Relay assignment 20

Fire see Heaters

G

- Gallons 13

H

- Heaters
 - 0-10V heat mats
 - Operation & settings 45
 - Probe selection 17
 - Activation 14
 - Copy & Paste curve see Curves
 - Heater programs 14
 - Heaters' offset curve see Curves

- Humidity compensation
 - Principle of operation 49
 - Settings 49
 - Lo/Hi fire
 - Activation 14
 - Operation & Settings 43–44
 - Operation & Settings 43–44
 - Probe assignment 17
 - Relay assignment 18
 - RH compensation see Rel. humidity
 - Run times 55
 - History 54–55
 - House temperature see Temperature
 - Humidity see Relative humidity
- I**
- Inlet
 - Attic Inlet
 - see Attic
 - Inlet (connected to SB Modules)
 - Activation 14
 - Current opening 54
 - Inlet's T° & pressure compensation
 - Activation 16
 - Principle of operation 33
 - Operation & settings 32, 33
 - Probe assignment 17
 - Inputs 5, 14
 - Insect filter 8
 - Installation setup 14–16
 - Worksheet 60, 61
 - Installer password 12
- L**
- LCD screen
 - Contrast adjustment 11, 58
 - Leds
 - Led display 11
 - Unit selection 16
 - Status leds 11
 - Lights (0-10V)
 - Activation 14, 46
 - Current intensity 54
 - Principle of operation 46
 - Settings 46
 - Liters 13
 - Logs see also History
 - Alarm log 50
- M**
- Manual mode see Test mode
 - Measuring units 13
 - Memory card
 - Transfer process 58
 - Message center 56
- Minimum ventilation
 - Compensation 25
 - Min. vent. curve see Curves
 - Principle of operation 23
 - Ramping function
 - Principle of operation 25
 - Settings 15
 - RH compensation see Rel. Humidity
 - Settings 23
 - Speed curve see Curves
 - Mist see Cooling outputs
 - Mounting instructions 7
- N**
- Natural ventilation zones
 - Activation 14
 - Curains' relay assignment 19
 - Principle of operation 41
 - Probe assignment 17
 - Settings 42
 - Tunnel curtain in natural ventilation
 - Activation 15
 - Night see Day / Night
- O**
- Outputs 5
 - Outputs (0-10V)
 - see Lights, Heaters, or Fan stages
 - Outside T° see Temperature
- P**
- Parameter adjustment 11
 - Password 12
 - Potentiometer (for inlets)
 - Activation 16
 - Pressure see Static pressure
 - Probe
 - Connection 7
 - Extension 7
 - Probes
 - Activation 14, 15
 - Assignment
 - Make the assignment 17
 - Calibration 17
 - Current active probes 54
 - Current readings 54
 - Programs
 - Activation 14
 - Clock programs see Clock outputs
 - Copy/paste program settings 13
 - Heater programs 14
 - Light programs see 0-10V outputs
 - Program selection 13
 - Program version (controller's) 21
- R**
- Ramping see also Curves
 - Min. ventilation ramping
 - Activation & settings 15
 - Principle of operation 25
 - Relative humidity (RH)
 - History 54
 - RH Compensation
 - Principle of operation 49
 - Settings 49
 - RH sensor
 - Activation 15
 - Calibration 17
 - RH set point 49
 - Relays
 - Activation 14
 - Backup relay box 20
 - Common relays
 - Principle of operation 20
 - Selection 20
 - Copy/Paste 19
 - Current active relays 54
 - Low SP alarm relay 52
 - Relay assignment 18–19
 - Worksheet 64
 - Relay panels 18
 - Run time history 56
 - Stir fans relays
 - Activation 15
 - Assigning stir fan relays 18
 - Principle of operation 18
 - Timer-based relays
 - Operation & Activation 18
 - Settings 19
 - Reset (vent door's position) 37, 38
 - Room temp. see also Temperature
 - Probe assignment 17
- S**
- Screens
 - see LED or LCD Display
 - Season selection 13
 - Sensors see Probes
 - Set point see Temperature
 - Setup (Installation) 14–16
 - Shortcut keys 11
 - Sidewall vents
 - see Vent doors
 - Simulation see Test mode
 - Speed (communication) 58
 - Static pressure (SP)
 - Current pressure level 54
 - Groups of SP settings
 - See Vent doors or Tunnel Curtain
 - Measuring units 13
 - Pressure alarms 52
 - Low alarm curve 16, 52
 - SP Probe
 - Activation 15

- Calibration 17
- Static pressure simulation 21
- Tubing installation 8
- Vent doors see Vent doors
- Stir fans
 - Activation 15
 - Principle of operation 18
 - Relay selection 18
- Summer see Seasons
- T**
- Technical specifications 57
- Temperature
 - Average room temperature
 - Current average T° 54
 - Probe assignment 17
 - T° History 54
 - Critical temperature 51
 - Outside temperature
 - Activation (Out T° probe) 15
 - Current reading 54
 - History 54
 - Outside influence on T° alarms 51
 - Out. T° Influence on SP groups 36
 - Probes
 - Probe assignment 17
 - Set points
 - Current set point 54
 - Curve 14, 22
 - Night set point 14, 22
 - Operation & settings 22
 - Temperature alarms
 - Principle of operation 51
 - Settings 51
 - Temperature curve see Curves
 - Temperature simulation 21
 - Temperature units 13
- Test mode 21
- Time
 - Adjusting improper system time 12
 - Setting the time and date 12
 - Time format 13
- Timer-based relays see Relays
- Timer see Clock outputs
- Tubing installation (Static pressure) 8
- Tunnel curtain (pressure-based)
 - Activation 15
 - Multiple tunnel stage with age
 - Activation 15
 - Principle of operation 29
 - Open tunnel on alarm 52
 - Pre-opening
 - Activation (normal or tunnel help) 15
 - Pre-opening delay 15
 - Principle of operation 29
- Relay assignment 19
- Settings 30
- Static pressure (2nd group settings)
 - Activation 16
 - Settings 30
 - Transition 36
- Transition from lateral to tunnel 15
- Tunnel help 15
- Used in natural ventilation
 - Activation 15
- Tunnel curtain (timer-based)
 - Activation 15
 - Multiple tunnel stage with age
 - Activation 15
 - Principle of operation 31
 - Principle of operation 31
 - Relay assignment 19
 - Settings 31
 - Transition from lateral to tunnel 15
- U**
- Units 13
- User-defined shortcut key 11
- User password 12
- V**
- Variable fans see Fan stages
- Vent doors (pressure-based)
 - Activation 16
 - Open vents on alarm 52
 - Pre-opening delay 16
 - Principle of operation 35
 - Relay assignment 19
 - Settings 36
 - Static pressure (2nd group settings)
 - Activation 15
 - Settings 35
 - Transition 36
 - Transition from lateral to tunnel 15
- Vent doors (timer-based)
 - Activation 16
 - Principle of operation 37
 - Relay assignment 19
 - Settings 37
- Vent doors (with potentiometer) see Inlets
- Ventilation see Fan stages or Min. Vent.
- Version 21
- W**
- Water meter
 - Activation 14
 - Measuring units 13
- Water consumption
 - Consumption history 54
 - Current reading 54
 - Water spill alarm 53
- Weather see Temperature
- Wind delay 42
- Winter see Seasons
- Wiring 7
- Worksheet
 - Installation setup 60, 61
 - Relay assignment 64
- Z**
- Zero-crossing screen 50

