

Installation manual

AC-2000
SE/Plus
Pigs



AC-2000

Climate Controller for Pigs

Ag/MIS/IGB-2150-11/13 Rev 1.2
P/N: 116118

AC-2000 for Pigs

Manual for use and maintenance

Revision: N.1.2 of 09.2019

Ag/MIS/IGB-2150-11/13 Rev 2.1

Product Software: Version 8.11

This manual for use and maintenance is an integral part of the apparatus together with the attached technical documentation.

This document is destined for the user of the apparatus: it may not be reproduced in whole or in part, committed to computer memory as a file or delivered to third parties without the prior authorization of the assembler of the system.

Munters reserves the right to effect modifications to the apparatus in accordance with technical and legal developments.

Index

<i>Chapter</i>		<i>page</i>
1	INTRODUCTION	5
1.1	Disclaimer	5
1.2	Introduction	5
1.3	Notes	5
2	SAFETY ASPECTS	6
2.1	Grounding	6
2.2	Filtering	6
2.3	Checking the battery level	6
2.4	Frequency inverters	6
3	INSTALLATION	8
3.1	Mounting the unit	8
3.2	AC-2000 Plus Wiring	8
3.2.1	AC-2000 Plus Board layout	9
3.2.2	AC-2000 Plus Relays	10
3.2.3	AC-2000 Plus High voltage wiring (relays)	11
3.2.4	AC-2000 Plus Pigs terminals	12
3.2.5	AC-2000 Plus Low Voltage Wiring (Terminals)	14
3.3	AC-2000 SE Wiring	15
3.3.1	AC-2000 Board Layout	16
3.3.2	AC-2000 SE Relays	17
3.3.3	AC-2000 SE High Voltage Wiring (Relays)	18
3.3.4	AC-2000 SE Terminals	19
3.3.5	AC-2000 SE Low Voltage Wiring (Terminals)	20
3.4	MUX / RCLP Wiring	21
4	CONFIGURATION	22
4.1	Configuration (Menu 91)	23
4.2	Ventilation table (Menu 92)	24
4.3	Relay layout (Menu 93)	25
4.3.1	Manual relay operation	26
4.3.2	Relay record	27
4.4	Sensor layout (Menu 94)	27

4.5	Setup curtains (Menu 95)	28
5	TECHNICAL DATA	29
6	TROUBLESHOOTING GUIDE	30
7	ELECTRICAL GROUNDING	32
7.1	Ground rods	32
7.2	Ground wire	32
7.3	Ground clamps	33
7.4	What should be grounded?	33
7.5	Lightening protection	33
	7.5.1 Power line protection	33
	7.5.2 Communication line protection	33
8	APPENDIX A: INSTALLING A CO2 SENSOR	34
8.1	Low Voltage Wiring	34
8.2	Configuring the CO2 Sensor	35
9	WARRANTY	36

1 Introduction

1.1 Disclaimer

Munters reserves the right to make alterations to specifications, quantities, dimensions etc. for production or other reasons, subsequent to publication. The information contained herein has been prepared by qualified experts within Munters. While we believe the information is accurate and complete, we make no warranty or representation for any particular purposes. The information is offered in good faith and with the understanding that any use of the units or accessories in breach of the directions and warnings in this document is at the sole discretion and risk of the user.

1.2 Introduction

Congratulations on your excellent choice of purchasing an AC-2000!

In order to realize the full benefit from this product it is important that it is installed, commissioned and operated correctly. Before installation or using the fan, this manual should be studied carefully. It is also recommended that it is kept safely for future reference. The manual is intended as a reference for installation, commissioning and day-to-day operation of the Munters Controllers.

1.3 Notes

Date of release: November 2013

Munters cannot guarantee to inform users about the changes or to distribute new manuals to them.

NOTE All rights reserved. No part of this manual may be reproduced in any manner whatsoever without the expressed written permission of Munters. The contents of this manual are subject to change without notice.

2 Safety aspects

- Grounding
- Filtering
- Checking the Battery Level
- Frequency inverters

2.1 Grounding

- Always connect temperature and sensor shields to earth ground.
Avoid mixing high voltage wiring with sensor and low voltage wiring.
Keep the controller as far as possible from heavy contactor boxes and other sources of electrical interference.
- Do not connect communication wire shields, which go from one house to another at both ends.
Connect them at one end only. Connection at both ends can cause ground loop currents to flow, which reduce reliability.
- The COM connection for communications is not the shield wire. The COM, RX and TX wires must connect to each other at all controllers.

2.2 Filtering

If this installation includes a power inverter to drive variable speed fans, install an EMI filter in front of the inverter, according to the specifications provided by the inverter manufacturer. Refer to the inverter documentation.

2.3 Checking the battery level

Check the battery once a year. The output must be 2.7 volts (minimum). Authorized personnel only must replace the battery if the output is below the minimum required level or every five years.

2.4 Frequency inverters

Frequency inverters can cause severe electrical and electromagnetic interference. Therefore, when employing a frequency inverter, it is critical that you carefully follow the manufacturer's installation instructions. In particular verify:

- that the cable shielding between the inverter and any motor meets industry standards
- proper grounding of the inverter's chassis and motor power cable
- proper grounding of low voltage cable shield wire
- that the controller and inverter cables are kept in separate conduits or wire bundles

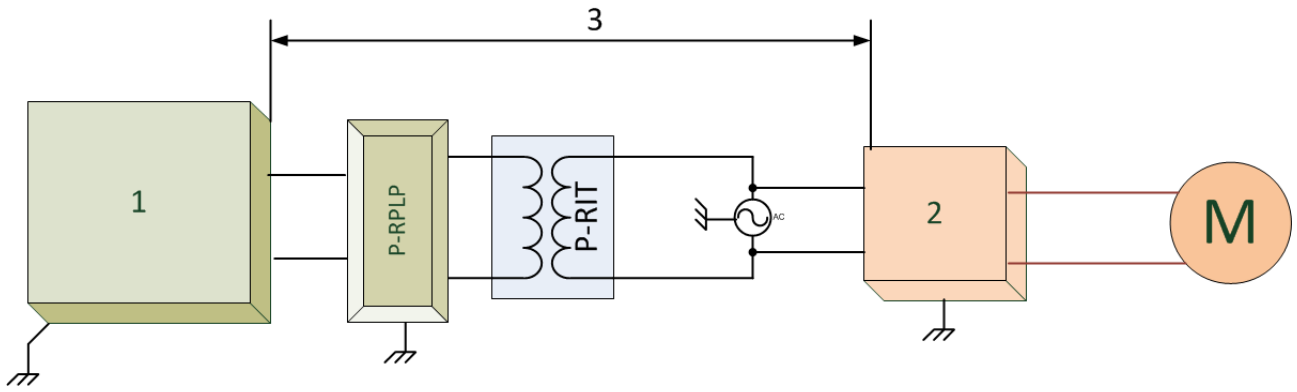

1. Controller
2. Inverter
3. Place the controller at least five meters from the inverter

3 Installation

This manual details the installation procedures for the **AC-2000 Pig Controllers**.

- Mounting the Unit
- AC-2000 Plus Wiring
- AC-2000 SE Wiring
- MUX / RCLP Wiring

3.1 Mounting the Unit

1. Install the AC-2000 Pigs in a dry well lighted area, preferably in an annex to the main poultry house.
2. Mount it using the three holes provided; one in each of the left and right lower corners, accessible from the front under the terminal strip cover, and one top center in the back. The top center hole is a keyhole variety.
3. Install the screw for this hole first to about 0.1 inches of the wall surface.
4. Hang the controller on this screw. Install the other two screws to fasten the **AC-2000 Pigs**.

CAUTION Always connect temperature and sensor shields to earth ground. However, do not connect communication wire shields, which go from one house to another at both ends. Connect them at one end only. Connection at both ends can cause ground loop currents to flow, which reduce reliability.

CAUTION The COM connection for communications is not the shield wire. The COM, RX and TX wires must connect to each other at all AC-2000 Pigs controls.

CAUTION Avoid mixing high voltage wiring with sensor and low voltage wiring.

CAUTION Keep the AC-2000 Pigs as far as possible from heavy contactor boxes and other sources of electrical interference.

Refer to Electrical Grounding, page 32 for information on grounding the unit.

3.2 AC-2000 Plus Wiring

The following sections detail the AC-2000 Plus wiring.

- AC-2000 Plus Board layout
- AC-2000 Plus Relays
- AC-2000 Plus High Voltage Wiring (Relays)
- AC-2000 Plus Pigs terminals
- AC-2000 Plus Low Voltage Wiring (Terminals)
- AC-2000 Plus Communication Wiring

3.2.1 AC-2000 Plus Board layout

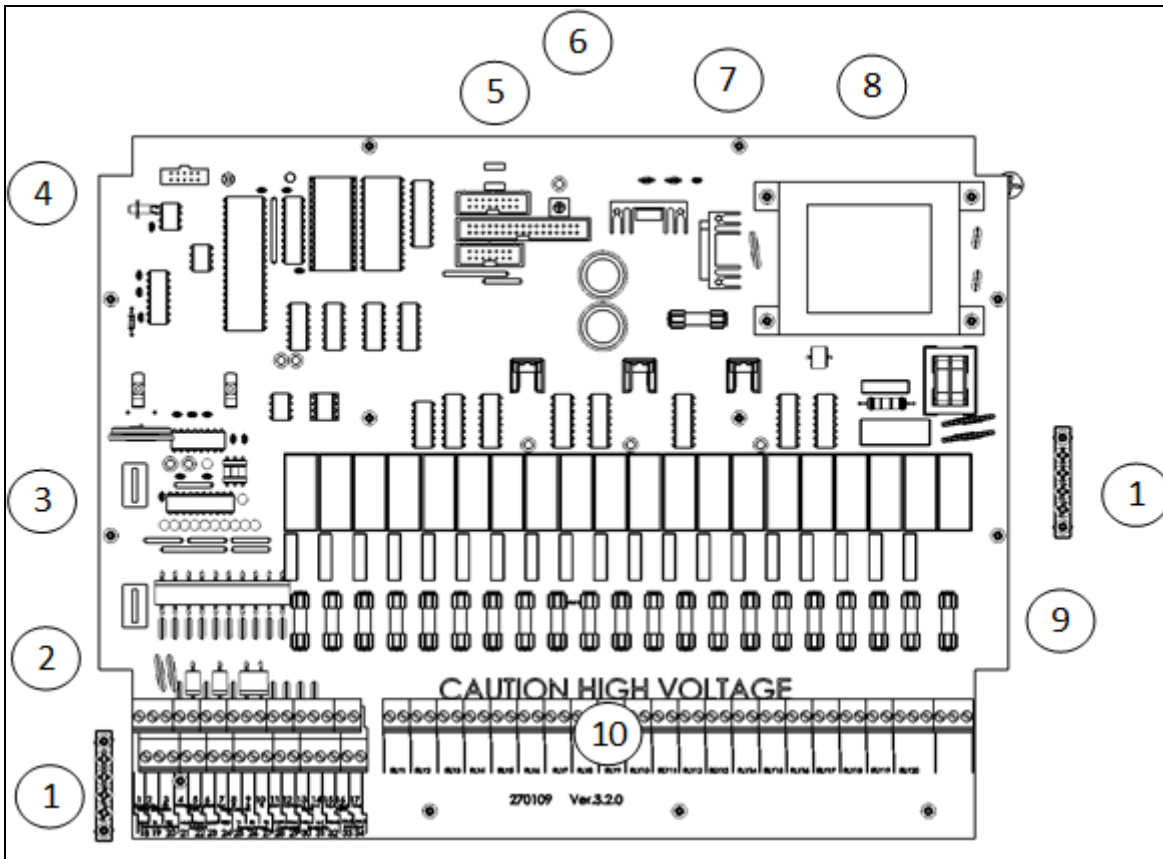

Figure 1: AC-2000 Plus Layout

Figure 1 key			
1	Ground strip	6	Key board connector
2	Backup battery	7	Voltage regulator
3	Internal Communication card	8	Transformer
4	Pressure sensor (optional)	9	5 amp fuses
5	LCD connector	10	20 relays

3.2.2 AC-2000 Plus Relays

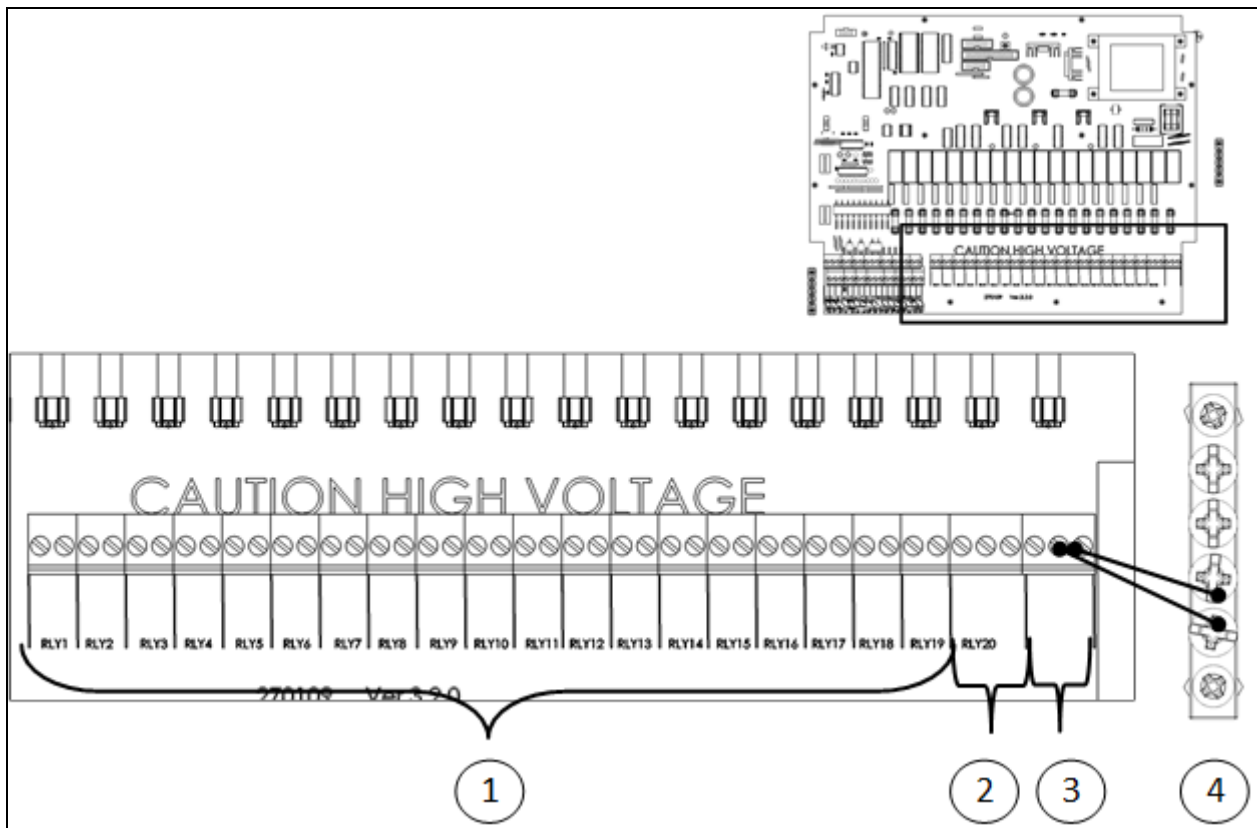

Figure 2: AC-2000 Plus Layout

1. Relays 1 to 19: Each pair of terminals goes to one relay. These relays are fused with a 5-ampere, 250 volt slow blow fuses. The relays are normally open when not powered.
2. Relay 20: Three terminal blocks: This relay normally serves as an alarm relay. It is also fused with a 5 ampere, 250 volt slow blow fuse, and can serve as an ordinary relay:
 - NC: Normally closed contact
 - Com: Common contact
 - NO: Normally open contact
3. Power: Three terminal blocks:
 - Neutral (N): Connect to the Neutral Power line.
 - Phase (~): Connect to the Phase Power line.
 - Ground (GND): Connect to a solid earth safety ground, normally with the bare safety ground wire, or a green wire.
4. **Ground:** Connect the ground wire to the electrical system.

3.2.3 AC-2000 Plus High Voltage Wiring (Relays)

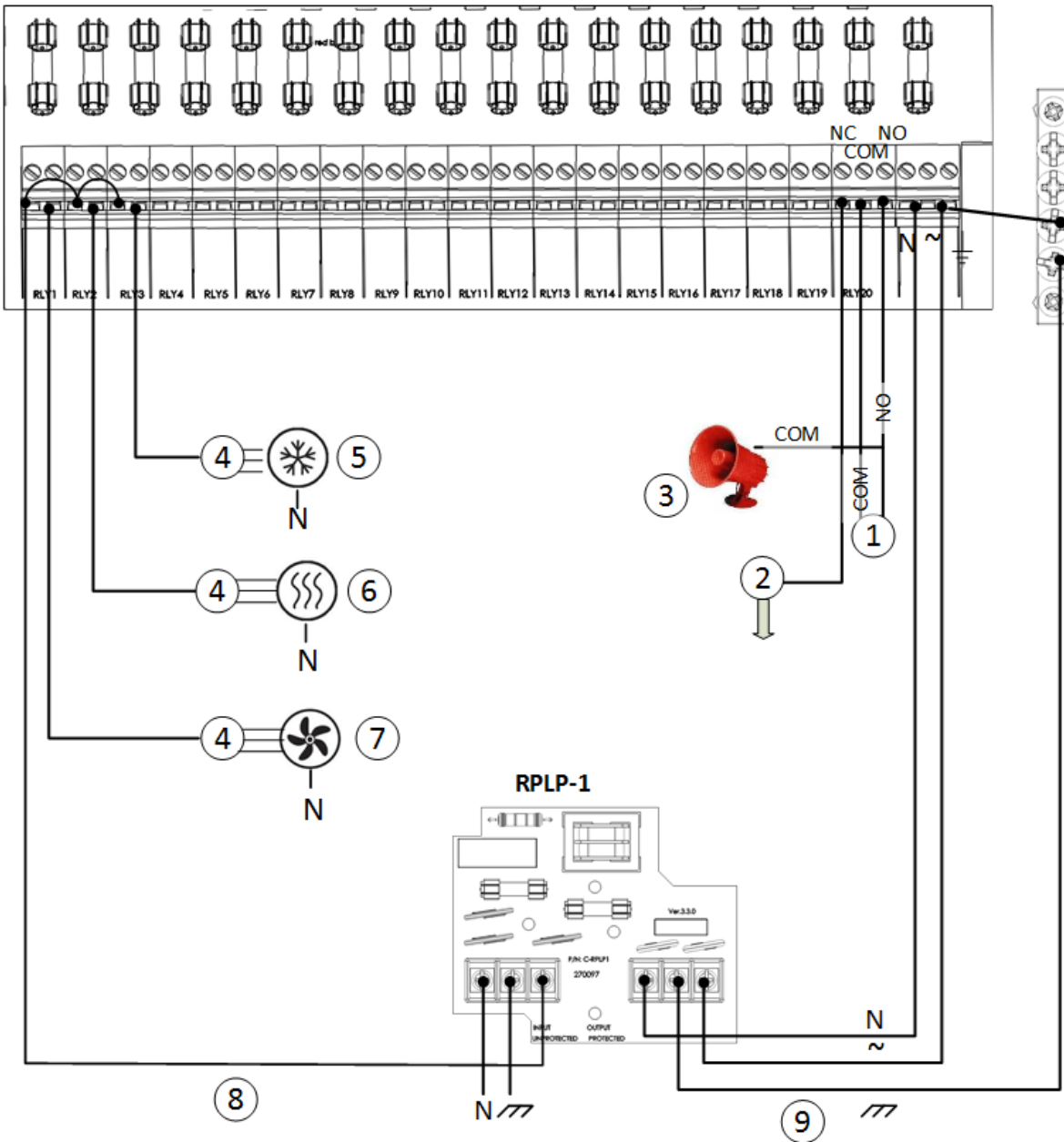

Figure 3: AC-2000 Plus High Voltage Wiring

Figure 3 key			
1	Alarm system	6	Heat 1
2	12V battery and Alarm (NC+)	7	Fan 1
3	Siren (Com -)	8	Unprotected input
4	3 phase contactor	9	Protected input
5	Cool 1		

NOTE The device connections (fan, heat, cool, etc.) that are shown in the drawing, are examples only!

CAUTION Connect the AC-2000 power input to the protected output only!

3.2.4 AC-2000 Plus Pigs terminals

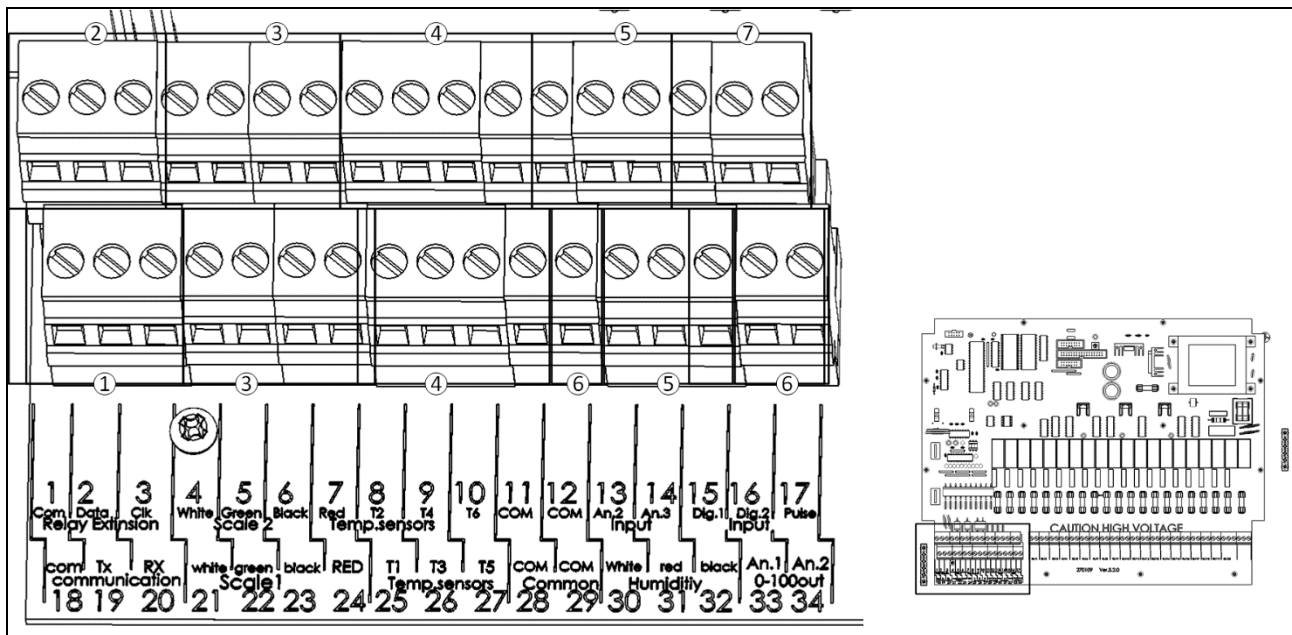

Figure 4: AC-2000 Plus Terminals

1. **Communications:** Three terminal blocks for PC communication using the optional multiplexor, MUX (P/N MUX 2 485).

- **RX (20):** Receive into AC-2000 Pigs. With multiple controls, connect all the RX pins together. Connect to TX at Multiplexor only.
- **TX (19):** Transmit from AC-2000 Pigs. With multiple controls, connect all the TX pins together. Connect to RX only at Multiplexor only.
- **COM (18):** Ground reference for communications. Do not connect shields to this pin. Connect to COM at multiplexor also.

2. **Relay Extension: Com (1) -** The relay extension box such as the *AC-2000 Extension* may be located up to 10 feet from the AC-2000 Pigs. Do not connect the shield to this terminal. Connect the shield to earth ground only at one end of the cable to avoid ground loops.

- **Data (2):** This line carries data to the relay extension.
- **Clk (3):** This line carries a clocking signal for use by the relay extension.

3. Not used.

4. **6 Temperature Sensors (8, 9, 10, 25, 26, 27):** The temperature sensor is a 2 wired black shielded cable thermistor (RTS-2). Connect one wire to the temperature sensor terminal and the other to common (11, 28) *Polarity does not matter.

5. Analog Inputs:

- **Humidity Sensor (30, 31, 32):** Connect according to wire colors (White, Red, Black).
- **An.2 (13):** Humidity Outside Humidity input. Connect the white wire of the Humidity sensor to An.2 and the red and black together with the Humidity input red and black.
- **An.3 (14):** Pressure sensor (Connect + red wire to An.3 and Black - wire to Common).

6. Analog Outputs:

- **An.1 (33)**: 0 to 10V- Light Intensity control signal
- **An.2 (34)**: 0 to 10V- Variable speed control signal
- **COM (29)**: Connect the common wire of An.1 & 2 to terminal 29

7. Digital Inputs:

- **Dig 1 (15)**: Feed overtime alarm input or wind direction selection
- **Dig 2 (16)**: Feed counter
- **Dig 3 (17)**: Water meter

3.2.5 AC-2000 Plus Low Voltage Wiring (Terminals)

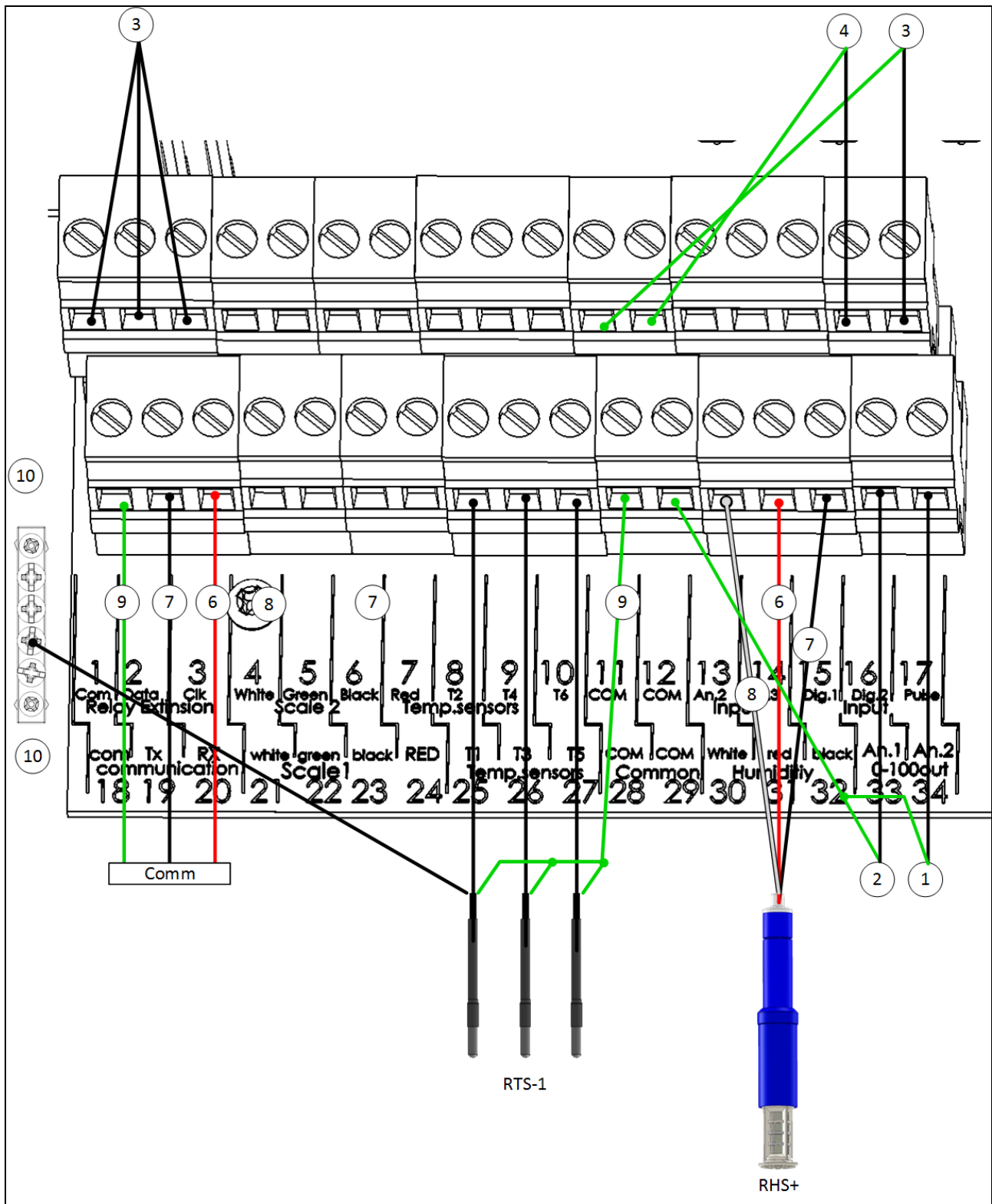

Figure 5: AC-2000 Plus Low Voltage Wiring

Figure 5 key

1	0 - 10 volt variable speed sensor	6	Red wire
2	0 - 10 volt variable dimmer	7	Black wire

Figure 5 key			
3	Relay ext.	8	White wire
4	Feed Counter	9	Green wire
5	Feed overtime alarm or wind directions	10	Shield wire

- Connect each cable's shielding wire to the grounding strip. The drawing above is an example only.
- User employing a CO2 sensor, refer to Appendix A: Installing a CO2 sensor, page 34.

3.2.6 AC-2000 Plus Communication Wiring

AC-2000 Plus is wired to a MUX/Communicator via:

- an internal communication card (P/N C-AC-2000-C232). Connect the communication wires shown in directly to the MUX / Communicator **OR**
- an external RCLP card (see MUX / RCLP Wiring, page 21 for wiring instructions)

3.3 AC-2000 SE Wiring

The following sections detail the AC-2000 SE wiring.

- AC-2000 Board Layout, page 16
- AC-2000 SE Relays, page 17
- AC-2000 SE High Voltage Wiring (Relays), page 18
- AC-2000 SE Terminals, page 19
- AC-2000 SE Low Voltage Wiring (Terminals), page 20

3.3.1 AC-2000 Board Layout

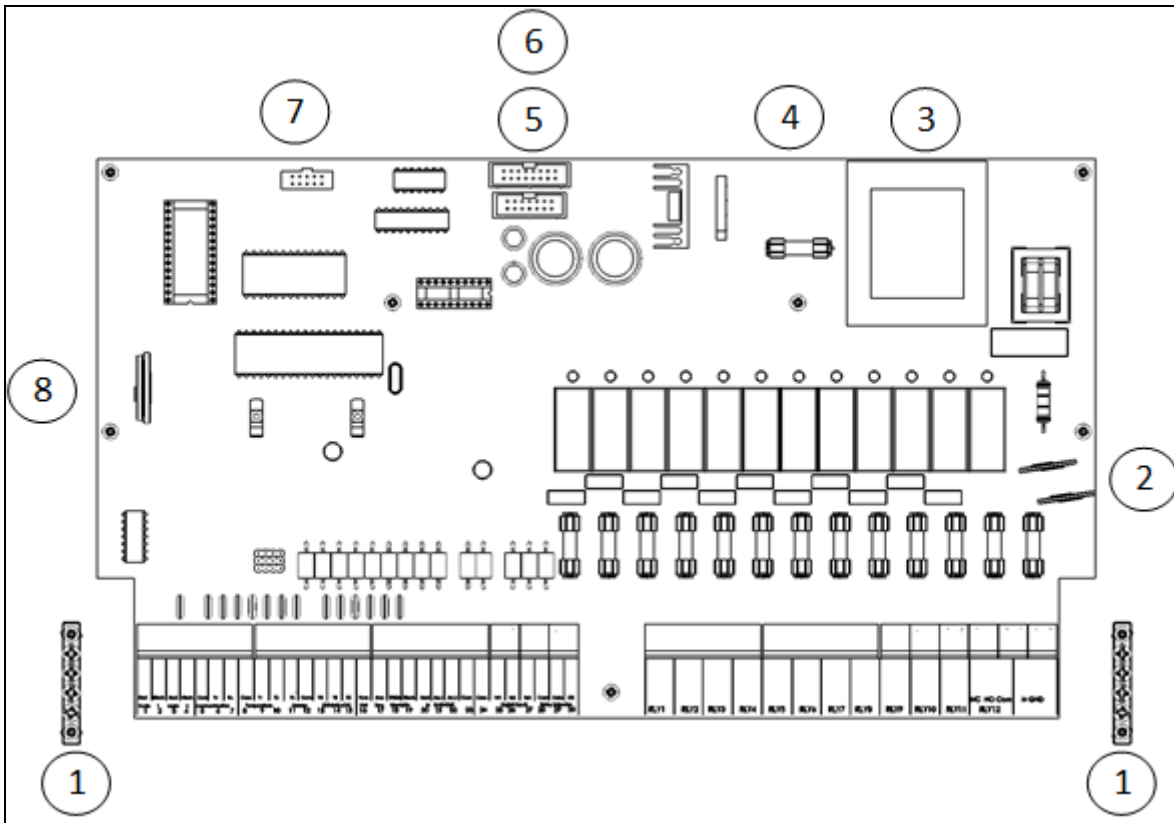

Figure 6: AC-2000 SE Layout

Figure 6 key			
1	Ground strip	5	Key board connector
2	5 Amp fuse	6	LCD connector
3	Transformer	7	Static pressure sensor (option)
4	Voltage regulator	8	Battery

3.3.2 AC-2000 SE Relays

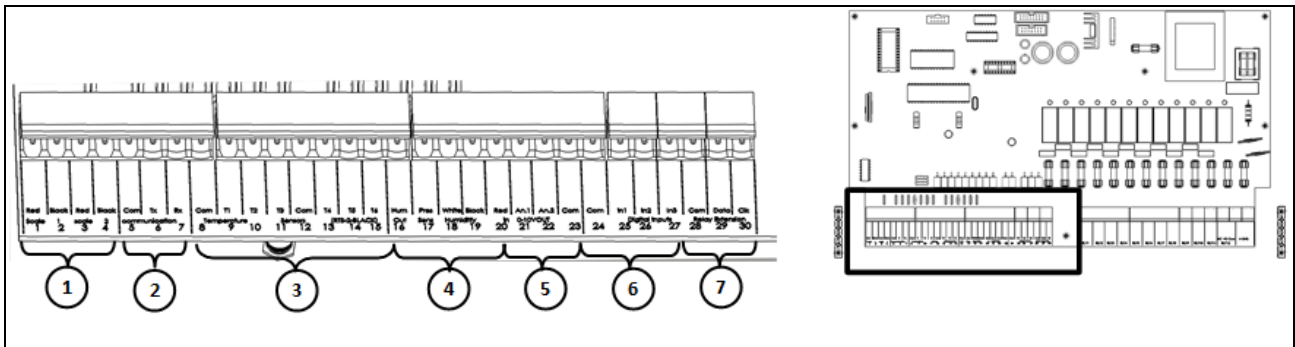

Figure 7: AC-2000 SE Relays

1. **Relays 1 to 11:** Each pair of terminals goes to one relay. These relays are fused with a 5-ampere, 250-volt slow blow fuses. The relays are normally open when not powered.
2. **Relay 12:** Three terminal blocks: This relay normally serves as an alarm relay. It is also fused with a 5 ampere, 250 volt slow blow fuse, and can serve as an ordinary relay:
 - **NC:** Normally closed contact.
 - **Com:** Common contact.
 - **NO:** Normally open contact.
3. **Power:** Three terminal blocks:
 - **Neutral (N):** Connect to the Neutral Power line.
 - **Phase (~):** Connect to the Phase Power line.
 - **Ground (GND):** Connect to a solid earth safety ground, normally with the bare safety ground wire, or a green wire.
4. **Ground:** Connect the ground wire to the electrical system.

3.3.3 AC-2000 SE High Voltage Wiring (Relays)

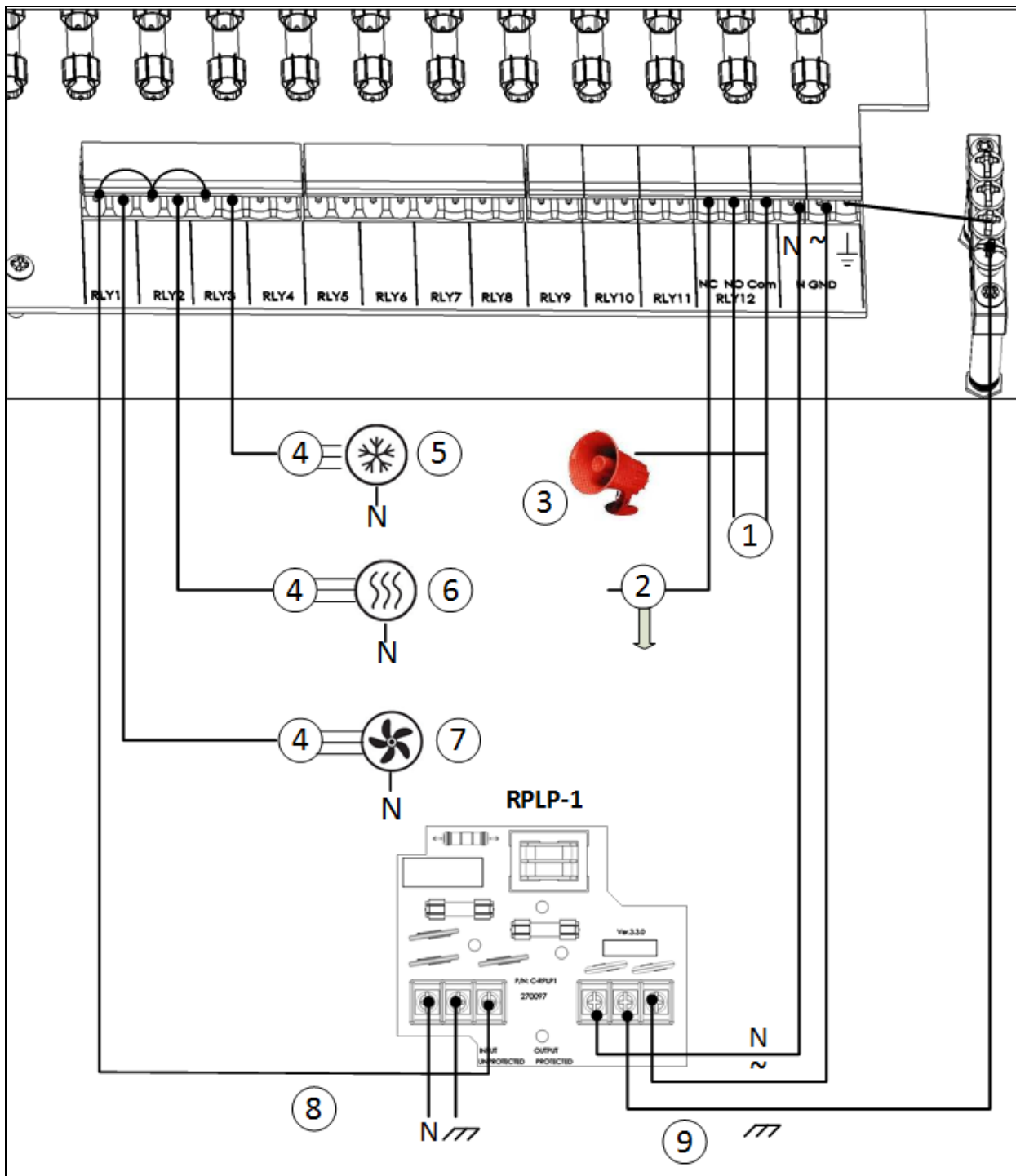

Figure 8: AC-2000 SE High Voltage Wiring

Figure 8 key			
1	Alarm system	6	Heat 1
2	12V battery and Alarm (NC+)	7	Fan 1
3	Siren (Com -)	8	Unprotected input
4	3 phase contactor	9	Protected input
5	Cool 1		

NOTE The device connections (fan, heat, cool, etc.) that are shown in the drawing are examples only!

CAUTION Connect the AC-2000 SE power input to the protected output only!

3.3.4 AC-2000 SE Terminals

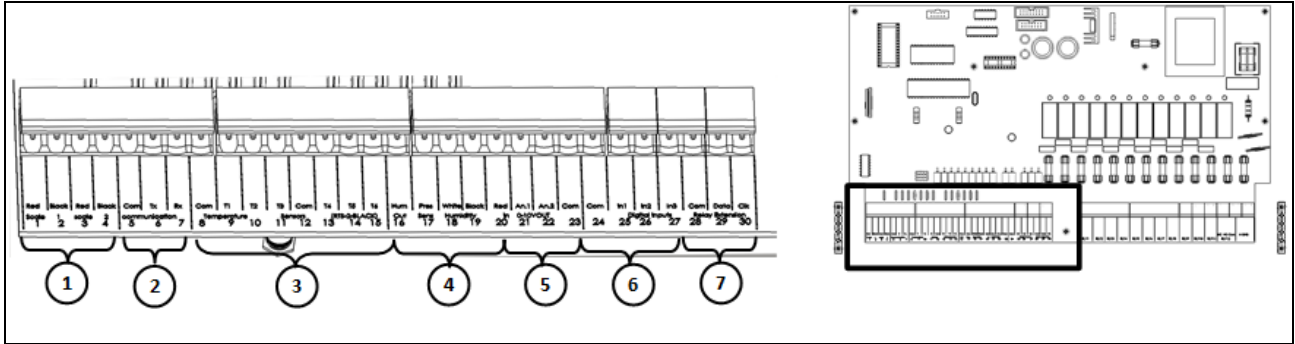

Figure 9: AC-2000 SE Terminals

1. **Not used.**
2. **Communications:** Three terminal blocks for PC communication using the optional multiplexor, MUX-2.
 - **RX:** Receive into **AC-2000 SE**. With multiple controls, connect all the RX pins together. Connect to TX at Multiplexor only.
 - **TX:** Transmit from **AC-2000 SE**. With multiple controls, connect all the TX pins together. Connect to RX only at Multiplexor only.
 - **COM:** Ground reference for communications. Do not connect shields to this pin. Connect to COM at multiplexor also.
3. **Temperature Sensors:** The temperature sensor is a 2 wired black shielded cable thermistor (RTS-2). Connect one wire to the temperature sensor terminal and the other to common (Polarity does not matter).
4. **Analog Inputs:**
 - **An.1:** Humidity sensor with wire connections according to wire colors.
 - **An.2:** Humidity Outside Humidity input. Connect the White wire of the Humidity sensor to An.2 and the Red and Black together with the Humidity input Red and Black.
 - **An.3:** Pressure sensor (Connect **Red (+)** wire → An.3; **Black (-)** → Common).
5. **Analog Outputs:**
 - **An.1:** 0 to 10V- Light Intensity control signal.
 - **An.2:** 0 to 10V- Variable speed control signal.
6. **Digital Inputs:**
 - **Dig 1:** Feed overtime alarm input or wind direction selection.
 - **Dig 2:** Feed counter.
 - **Dig 3:** Water meter.
7. **Relay Extension: Com** - The relay extension box such as the **REB-8** may be located up to 10 feet from the **AC-2000 SE**. Do not connect the shield to this terminal. Connect the shield to earth ground only at one end of the cable to avoid ground loops.
 - **Data:** This line carries data to the relay extension.
 - **Clk:** This line carries a clocking signal for use by the relay extension.

3.3.5 AC-2000 SE Low Voltage Wiring (Terminals)

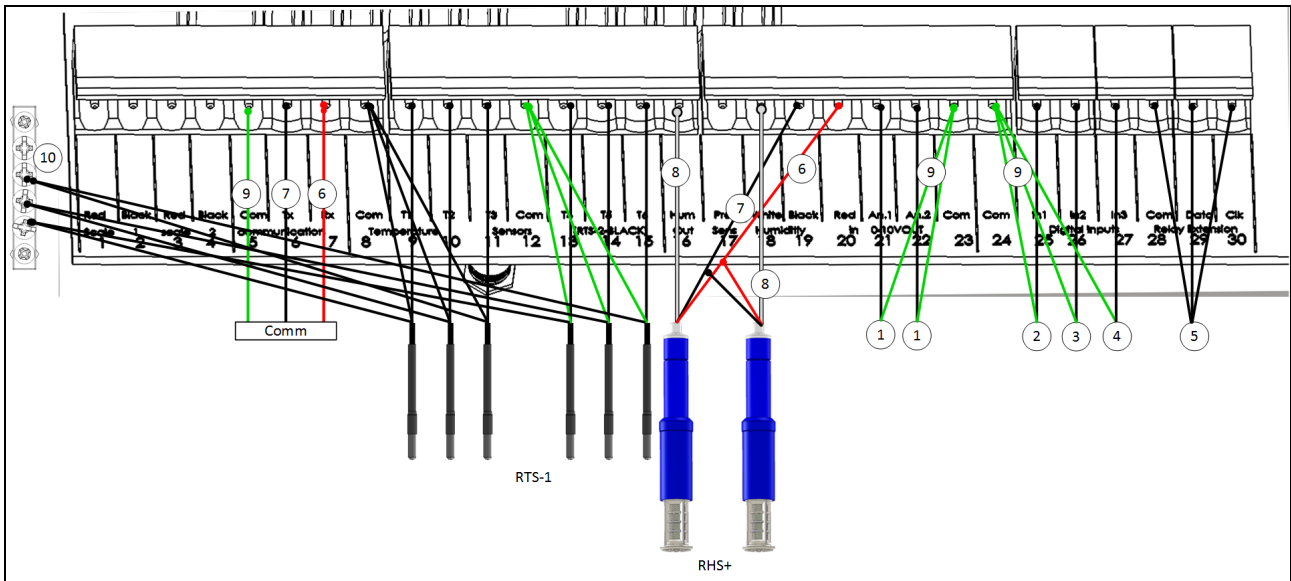

Figure 10: AC-2000 SE Low Voltage Wiring

Figure 8 key			
1	0 - 10 volt variable speed sensor	6	Red wire
2	0 - 10 volt variable dimmer	7	Black wire
3	Feed overtime alarm or wind direction	8	White wire
4	Feed Counter	9	Green wire
5	Water meter	10	Shield wire

- Connect each cable's shielding wire to the grounding strip. The drawing above is an example only.
- Connect the sensor shielding wire to the grounding strip.
 - 16 - Analog Input 2
 - 17 - Analog Input 3
 - 18 - Analog Input 1

NOTE The above illustration is an example only!

3.4 MUX / RCLP Wiring

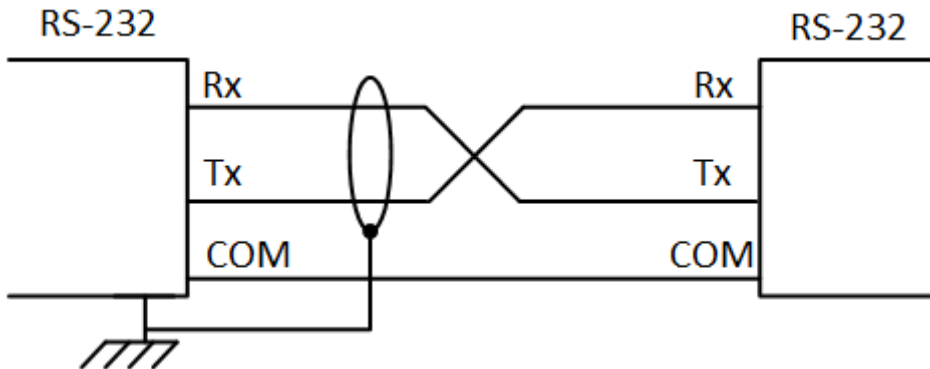

- The possible baud rate is dependent on the cable length and the number of controllers connected.
3-Shielded Cable:
 - For one controller:
 - 2000 meters: 9600 Baud
 - 2500 meters: 4800 Baud
 - 3000 meters: 2400 Baud
 - For 10 controllers:
 - 1200 meters: 9600 Baud
 - 1800 meters: 4800 Baud
 - 2400 meters: 2400 Baud
- Connect the cable shields only at 1) one end of every cable in the MUX-232 as illustrated and 2) one end of each house.
- Activation of the alarm system occurs when there is a circuit opening between the Normally Open and COM.

4 Configuration

Table 1: Configuration (Version 8.07)

91	Configuration
92	Ventilation Levels
93	Relay Layout
94	Sensor Layout
95	Setup Curtains
96	System Variables
97	Password

Table 2: Configuration (Version 8.09 and above)

91	Configuration
92	Ventilation Levels
93	Relay Layout
94	Sensor Layout
95	Setup Curtains
96	System Variables
97	Password
98	Wind Chill

The installation menus are not shown on the front panel of the control. They are not used in the day-to-day operation of the control, but only during initial installation.

To get to these menus from the default display:

1. Press **MENU**.
2. Enter the menu number from the Installation Menu.
 - Configuration (Menu 91), page 23
 - Ventilation table (Menu 92), page 24
 - Relay layout (Menu 93), page 25
 - Sensor layout (Menu 94), page 27
 - Setup curtains (Menu 95), page 28

4.1 Configuration (Menu 91)

- **Empty House:** This mode prevents new alarms from starting. Alarms that were active before entering empty house continue to be active. While in Empty House mode a blinking indication message constantly appears. Use this mode between herds when the house is empty and you don't want the alarms to operate. Default: 'off'.
 - Automatically exiting from an empty house occurs in the following cases:
 - Changing growth day
 - New herd
 - Switching from day '0' to day '1'
- Celsius or Fahrenheit selection
- **Communication baud rate** (1200, 2400, 4800 or 9600) for hookup to a personal computer or modem.
- **Maximum number of ventilation levels:** The **AC-2000 Pigs** supports up to 20 ventilation levels. However, limiting this to a smaller number simplifies the ventilation table.
- Analog out 1 (0-3)
- **Analog out 2 (0-3):** For each analog output the valid values are either 0, 1, 2 or 3
 - '0': None
 - '1': Variable fan
 - '2': Light
 - '3': Variable heater
- **First tunnel level:** When using tunnel ventilation, enter the ventilation level (in accordance with the ventilation and curtain level tables) at which the system starts tunnel ventilation.
- **Number of heating zones:** The **AC-2000 Pigs** can control up to six separate heating zones. For one zone only, the average temperature controls the heaters. For two or more zones, the assigned sensors control the heaters in each zone (**Menu 94**).
- **Automatic continuous temperature adjustment:** The **AC-2000 Pigs** uses precisely the values entered in the temperature tables for each growth period if this is '0'. For automatic interpolation between these entries, enter '1'. The options are as follows:
 - '0': without
 - '1': temperature
 - '2': temperature and Min/Max
- **Barn Number:** This identifies the particular barn for the personal computer at home. Use a unique number for each **AC-2000 Pigs** to enable the communication program to identify each controller.
- **Curtain opening and closing times:** Enter the number of seconds it takes the curtains to go from fully closed to fully open, and from fully open to fully closed for each curtain. The **AC-2000 Pigs** uses this value to calculate the run time for each curtain when it moves them.
- **Tunnel curtain opening and closing times**
- **Measurement Unit:** Set the unit to be used when setting the house/shed dimensions. This variable is used in calculating the wind chill correction factors (see the User Manual).
- **Air Capacity Unit:** '0' for M³/hour, '1' for CFM (cubic feet per minute); Default value = '0'

4.2 Ventilation table (Menu 92)

Ventilation Level	Ventilation Groups	On Minutes	Off Minutes	D i f f	V a r
1	1 0 0 0 0 0 0 0 0 0 0 0 0 0 0 0	0.5	9.5	0	0
2	1 0 0 0 0 0 0 0 0 0 0 0 0 0 0 0	1.0	9.0	0	0
3	1 0 0 0 0 0 0 0 0 0 0 0 0 0 0 0	2.0	8.0	0	0
4	1 0 0 0 0 0 0 0 0 0 0 0 0 0 0 0	3.0	7.0	0	0
5	1 0 0 0 0 0 0 0 0 0 0 0 0 0 0 0	5.0	5.0	0	0
6	1 2 0 0 0 0 0 0 0 0 0 0 0 0 0 0	1.0	0.0	0	0
7	1 2 0 0 0 0 0 0 0 0 0 0 0 0 0 0	0.5	1.0	0	0
8	1 2 0 0 0 0 0 0 0 0 0 0 0 0 0 0	1.0	1.0	0	0
9	1 2 3 0 0 0 0 0 0 0 0 0 0 0 0 0	1.0	0.0	0	0
10	0 0 0 0 0 0 0 0 0 0 0 0 0 0 0 0	0.5	1.0	0	0
11	0 0 0 0 0 0 0 0 0 0 0 0 0 0 0 0	1.0	1.0	0	0
12	0 0 0 0 0 0 0 0 0 0 0 0 0 0 0 0	1.0	0.0	0	0
13	0 0 0 0 0 0 0 0 0 0 0 0 0 0 0 0	0.5	1.0	0	0
14	0 0 0 0 0 0 0 0 0 0 0 0 0 0 0 0	1.0	1.0	0	0
15	0 0 0 0 0 0 0 0 0 0 0 0 0 0 0 0	1.0	0.0	0	0
16	1 2 3 4 0 0 0 0 0 0 0 0 0 0 0 0	1.0	0.0	1.0	0
17	1 2 3 4 5 0 0 0 0 0 0 0 0 0 0 0	1.0	0.0	2.0	0
18	1 2 3 4 5 6 0 0 0 0 0 0 0 0 0 0	1.0	0.0	3.0	0
19	1 2 3 4 5 6 7 0 0 0 0 0 0 0 0 0	1.0	0.0	4.0	0
20	1 2 3 4 5 6 7 0 0 0 0 0 0 0 0 0	1.0	0.0	4.0	0

Minimum Ventilation (levels 1-14)

First Tunnel Level (level 15)

Transitional (levels 12-14)

The **AC-2000 Pigs** increases the fan power as ventilation requirements rise. The increments should be proportional from level to level. This means that the ventilation increases about 50% to 100% at each level. For example, at Level One a single fan is set to 0.5 minutes on and 9.5 minutes off. At Level Two, if you set the fan to 1.0 minute on and 9.0 minutes off, there is a 100% increase. At a much higher level, such as ventilation level 15, an increase from 4 fans to 6 fans represents a 50% increase in fan power. Please review the example ventilation tables for this principle.

The ventilation table, **Menu 92**, defines the fan powered ventilation levels for the poultry house. This includes variable speed, timer and on/off fans for up to 20 levels of ventilation. At each ventilation level, a cycle timer can run the highest numbered fan group used at that level. With no values in the timer on and off fields, or only an off time or only an on time, the **AC-2000 Pigs** defaults to constant on operation.

Due to limited display size, the **AC-2000 Pigs** shows only the on-off timer or the variable speed setting at each level. Use **Menu 91**, item 4 to select which setting the **AC-2000 Pigs** shows. However, both settings remain in memory.

Since air movement provides a cooling effect, the **AC-2000 Pigs** provides a temperature differential at each level. This is particularly important in tunnel ventilation, where the cooling effect can be (- 12) °C. The **AC-2000 Pigs** waits until the target temperature plus the differential before using that ventilation level.

NOTE The ventilation table coordinates with the curtain table. For natural ventilation, one should regard the curtain table as part of the ventilation table. The two tables together serve as one larger table.

4.3 Relay layout (Menu 93)

Relay	Code	NO/NC
1	1	0
2	2	0
3	3	0
4	4	0
5	25	0
6	26	0
7...20	0	0

Select **Menu 93** for relay layout. Each relay may work normally or reversed using the NO/NC field. Most relays should be set to normal.

There are twelve/twenty relays inside the **AC-2000 Pigs SE / AC-2000 Plus Pigs** respectively, and there may be additional relay extensions. All the relays are numbered sequentially. Assigning the relay code to each relay causes it to assume the particular function. Simply changing the relay code changes the function of the relay.

The alarm output, **code 40**, should be normally closed so that the alarm activates on a power failure. In normally closed mode, the **AC-2000 Pigs** turns the relay on to turn the function off, and releases the relay to turn the function on. Usually, **Relay 12** is the alarm relay since it provides both normally open and normally closed contacts. With the extension box, **Relay 20** can serve as an alarm relay instead of Relay 12.

NOTE After defining the relay, configure System Variable (refer to the User Manual).

Code	Description
1 through 8	Ventilation Group 1 through 8
9, 10	Zone A Heat: Low, High
11, 12	Zone B Heat: Low, High
13, 14	Zone C Heat: Low, High
15, 16, 17	Zone A Radiant Heat: Low, High, Ignition
18, 19, 20	Zone B Radiant Heat: Low, High, Ignition

Code	Description
21, 22, 23	Zone C Radiant Heat: Low, High, Ignition
24	Cooling System
25	Lighting System
26	Feeding System
27, 28	Curtain 1: Open, Close
29, 30	Curtain 2: Open, Close
31, 32, 33	Extra Systems 1 through 3
34	Circulation Fans
35, 36	Positive Pressure Optimizer: Burner, Fan
37, 38	Static Pressure Air Inlet: Open, Close
39	Fogger
40	Alarm
42, 43	Tunnel open/close
45, 46	Curtain 3: Open, Close
47, 48	Curtain 4: Open, Close
49, 50	Zone D Heat: Low, High
51, 52	Zone E Heat: Low, High
53, 54	Zone F Heat: Low, High
55	Fan 9
56	Fan 10
57	Fan 11
58	Fan 12
59	Fogger 2

4.3.1 Manual relay operation

Any relay with a code of '0' is not part of the automatic system. However, it follows the NO/NC (Normally Open, Normally Closed) specification. To turn it on manually, (for an extended time, as for installing and for troubleshooting) specify code 0, and set NO/NC to 1. To turn it off manually, set NO/NC to 0.

This method has the advantage that the **AC-2000 Pigs** will not reset and return it to automatic operation, as it does with test **Menu 33**. It permits the installer as much time as needed to check wiring and electrical connections with the relay in a known position.

NOTE Return the relay code to the correct function so that AC-2000 Pigs can operate it properly.

4.3.2 Relay record

A permanent record of relay assignments on a small card at the **AC-2000 Pigs** provides important information for servicing. By referring to the card, the service person can quickly test the correct output and identify problems. Of course, written records of circuit breaker assignments, manual override switches, and other connection information should also be available.

4.4 Sensor layout (Menu 94)

The **AC-2000 Pigs** supports up to six heating zones, each with individual heaters. The average of the zones determines the overall house temperature for the ventilation system. **Menu 94** assigns particular sensors to the heating zones for temperature, humidity, and static pressure. It also assigns outside sensors.

Temp Zone A: 1
Temp Zone B: 0
Temp Zone C: 3
Temp Zone D: 0
Temp Zone E: 0
Temp Zone F: 0
Radiation Zone A: 1
Radiation Zone B: 0
Radiation Zone C: 0
Outside Temp: 4
Humidity A: 0
Humidity B: 1
Outside Humidity: 0
Static Pressure: 4 (Internal)

NOTE For half or third house brood, set up the zones to prevent averaging in the grow end sensor. If the cold grow end sensor averages with your heated zones, it causes the house temperature to read too cold. This does not affect the heating, since the heaters use the individual zone sensors. However, the ventilation may be incorrect and historical data may show incorrect temperatures since the grow end sensor may have a much different temperature. 'Extra' systems (relay codes 31, 32 and 33), or positive pressure optimizer, if set to average temperature, might work incorrectly.

Radiant heaters used as brooders can have their own dedicated sensors. These do not affect the average temperature reading. If a static pressure sensor is used, it must be connected to one of the analog inputs in place of a humidity sensor.

1. Temperature Zone Sensors A, B, C, D, E and F: Install on any of temperature inputs, 1 through 6. When partial house brooding, reduce the number of zones to exclude sensors not in the brood area. Otherwise, sensors in the grow end will cause erroneous readings.

2. Outside Temperature Sensor: Install one of the temperature inputs, 1 through 6. Ensure that the outside sensor has protection from direct sun and hot air currents from the poultry/animal house. Proper placement and shielding is important to successful outside temperature measurement.

3. Humidity Zone Sensors A, B and C: Install on any analog inputs, 1 through 3.

4. Outside Humidity Sensor: Install on analog input 2 (Out Hum. - 16).

5. Internal pressure sensor: Define as analog input 4.

NOTE If external pressure sensor RPS-1 is used, connect it to terminal 17 (Pres. Sens.) and define as Analog Input 3.

NOTE Users installing a CO2 sensor, refer to Appendix A: Installing a CO2 sensor, page 34.

4.5 Setup curtains (Menu 95)

Level	% 1	% 2	% 3	% 4	%Tunnel
1...9	0	0	0	0	0
10	15	15	15	15	15
11	25	25	25	25	25
12	40	40	40	40	40
13	60	60	60	60	60
14	80	80	80	80	80
15	100	100	100	100	100
16...20	0	0	0	0	100

Minimum Ventilation {

First Tunnel Level →

- Enter minimum opening percentage for each curtain.
- The curtain table defines curtain levels for up to five curtains (4 natural & 1 tunnel curtains) at natural ventilation levels.
- When in natural mode the tunnel curtain operates as a natural curtain.
- When entering tunnel ventilation mode, the side curtains are closed and the tunnel curtain opens to the minimum % defined in the table. If static pressure increases, the tunnel opens accordingly.
- Exhaust fans may cause curtains to cling to the wiring mesh. For this reason, system variable 23 can allow the **AC-2000 Pigs** to turn off the fans (all eight groups) if the curtains need to move at small openings. System variable 29 enables a static pressure/curtain movement interlock in case a curtain (relay codes 37 and 38) controls static pressure. The **AC-2000 Pigs** can then turn off the fans while adjusting the curtain to achieve the desired static pressure.

NOTE For Menus 96 - 97, refer to the User Manual.

5 Technical data

Input Power Voltage	One Phase 115 ± 10 VAC (USA and Canada)
	230 ± 20 VAC (Outside USA and Canada)
Relay Loads	5.0 Amps, 250 Volts, Fused
Analog Inputs	0 - 11 Volts, 10 Milliamps Maximum
Analog Output	0 - 10 Volts Current Limited with 100-Ohm Resistor
Digital Inputs	5 mA @ 5 Volts, Dry Contact
Operating Temperature Range	0° to +50° C (32° to 125° F)
Enclosure	Water and Dust Tight
Fuses	Main fuse: 0.315 Amps, 250 Volts
	Others: 5 Amps, 250 Volts

6 Troubleshooting guide

Problem: Temperature Sensor does not operate

Solution:

1. Replace Temperature sensor or connect it to another terminal.
2. Test the Sensor: Disconnect the two wires of the temperature sensor and measure the resistance.

For 25° C the resistance should be 30 Kohm. If the temperature is higher, the resistance should be lower (for example at 42° C the resistance should be 15Kohm). If the temp is less than 25°, the resistance should be higher than 30 Kohm (for example for 15° C the resistance will be 45 Kohm).

If no resistance is measured (∞) it could have been caused by a broken temperature sensor wire.

Problem: Humidity sensor does not operate

Solution:

1. Supply Voltage: Check the 12 VDC between the Humidity Red(+) and Black(-) terminal (it should be 7.5 V at least).
2. Check output voltage of the sensor between Humidity White (+) and Black (-). Note that it must be 0.5 ÷ 3.0 VDC (15% to 100% of RH).

NOTE If the voltage is 0 or more than 3V the sensor is probably bad.

If the voltage is right (for example 1.5V for 50%) and the **AC-2000 Pigs** displays the wrong value, it could be that this channel is bad. Move the white wire to a different analog input, define in Menu 94 (sensor layout) and check again.

3. Replace the Humidity Sensor (for **RHS-10PL** replace only the tip).

Problem: Static pressure sensor does not operate

Solution:

1. Check that the internal static pressure is defined as 4 in Menu 94 (sensor layout).
2. Shut OFF all fans and close all curtains and inlets so that pressure is at 0. Go to Menu 35 (Analog Input Test) and see that the received value is 65 counts. If it is not at 65 counts, calibrate the pressure sensor by the trimmer to 65.
3. Clean filters, and check that both tubes are not blocked.

Problem: Digital Input or pulse does not operate

Solution:

1. Disconnect the wires from the input and check the 5V between the digital input and the common terminal.

NOTE If there is no 5 V then probably the input has been damaged (The lightning protection device shorted or the pull-up resistor burned out).

2. Go to Menu 34 and short the digital input of the common. Check if '0' changes to '1'.
3. For the pulse input (water) use Menu 37 and check that the counter increase by one for every short across the pulse terminal.

Problem: Communication does not operate

Solution:

1. If Rx and Tx LEDs are permanently ON, switch the wires between the Rx and the Tx.
2. Check that all jumpers are in MUX position.
3. Check all house numbers. There should not be a house number defined as zero, or two houses with same house number.
4. Check that all controllers have the same baud rate, and same as PC.
5. Connect only one controller to the network and check communication. A faulty RCLP can cause the whole network to not communicate.
6. Replace the suspected faulty RCLP.
7. Sometimes the Opto-Coupler isolators in the communication adaptor could be damaged from lightning and needs to be replaced.

Problem: Relays do not operate

Solution:

1. If only one relay is not working, check the related fuse.
2. If a group of 4 or 8 relays are not working, it could be that one of the relay coils shorted causing the thermal fuse (automatic fuse) to short.

Problem: Sporadic resets caused by interference

Solution:

- It is recommended to install a snubber at the source of interference (for example contactors or motors).

7 Electrical grounding

CAUTION Always connect temperature and sensor shields to earth ground.
Avoid mixing high voltage wiring with sensor and low voltage wiring.
Keep the controller as far as possible from heavy contactor boxes and other sources of electrical interference.

7.1 Ground rods

Ground rods are used to efficiently connect the system to earth where current may be dissipated in the soil.

- **Material:** Ground rods should be copper clad or galvanized steel.
- **Diameter:** Minimum 5/8", preferably 3/4". Generally the larger the rod diameter, the lower it's resistance to current flow.
- **Length:** Minimum 2.5 meters (8 feet), preferably 3-meter (10-foot). A longer ground rod will reach a soil with higher moisture content. Moist soil carries current much better than drier soil.
- **Single grounding:** It is important that there is only one grounding location where a rod or series of rods are connected to each other using a ground wire.
- Independent ground rods will increase the risk of current, from a lightning strike for example, being dissipated through one rod and reentering the system through an adjacent rod.
- **Location:** Close to the main circuit breaker panel and in moist soil. For example in an area that is usually wet from a drip or a low spot where water drains. Make sure the area is well protected from damage by lawnmowers, tractors, etc'.
- **Rod installation:** Drive the rod into the earth until about 10 cm (4 inches) is left above grade. If it is impossible to drive the rod to the proper depth, it is acceptable to lay the rod horizontally, 80 cm (2.5 feet) below grade.

In case the rod is exposed to damage, for example by lawnmowers or tractors it can be installed in a hole, about 20 cm (8 inches) deep so that the rod is about 10 cm under grade and 10 cm above hole level.



The National Electric Code (NEC) mandates two ground rods unless you can show less than 10 ohms resistance with one rod.

7.2 Ground wire

The ground wire is a large copper wire that connects the main circuit breaker panel to the ground rod.

- **Material:** Ground rods should be copper clad or galvanized steel.
- **Diameter:** Typically, 16 mm (6-gauge) copper wire is sufficient. If the wire run is greater than 20 feet, 20 mm (4-gauge) wire should be used.
- **Length:** Minimum 2.5 meters (8 feet), preferably 3-meter (10-foot). A longer ground rod will reach a soil with higher moisture content. Moist soil carries current much better than drier soil.

The ground wire should be protected from damage by lawnmowers, tractors, etc'. It should be buried minimum 15 cm (6 inches) under grade for protection and enter the house as soon as possible. It is important that the wire not be cut; it should remain continuous.

7.3 Ground clamps

Ground wires should not be merely wrapped around a ground rod. Ground clamps are used to attach a ground wire to a ground rod. The most common clamp is known as an acorn clamp. Make sure the ground clamps you select are rated for outdoor use. Do not use pipe clamps rated for inside water lines or hose clamps to attach the ground wire.

7.4 What should be grounded?

Any equipment that is or could become energized, even accidentally, should be grounded. Current from lightning, strikes objects in a random fashion. Accounts of lightning strikes reveal scenarios most of us could not predict.

Electric circuits should be wired with a 3-wire conductor consisting of hot, neutral and grounding wires. The grounding wire should be attached cleanly and securely to devices or systems to be grounded. The other end of the grounding wire should be attached to the ground bus on the main panel.

7.5 Lightning protection

Because of the potential for lightning damage to electronic devices, Munters recommends supplying lightning protection on both the power supply and the communication terminals (if used).

7.5.1 Power line protection

The Munters **RPLP-1** provides lightning protection to the **AC-2000 Pigs Controllers**. Refer to the **RPLP-1** documentation for detailed wiring instructions. While no lightning protection is perfect, the **RPLP-1** significantly enhances the reliability of built-in lightning protection. In addition, Munters recommends using an isolation transformer in front of the **RPLP-1** to help block lightning and other transients.

NOTE Common surge protectors provide little additional protection, and may trip unnecessarily.

An isolation transformer preceding the **RPLP-1** provides significant additional protection against lightning.

7.5.2 Communication line protection

The Munters **RCLP-1** provides communication protection for the **AC-2000 Pigs**. Refer to the **RCLP-1** documentation for detailed wiring instructions. Since outdoor communication lines can receive and conduct powerful electromagnetic pulses into the controllers and cause significant damage, Munters advises using a **RCLP-1** prevent damage to the units.

NOTE Common surge protectors provide little additional protection and may trip unnecessarily.

8 Appendix A: Installing a CO2 sensor

The following section details the steps involved in installing a CO2 sensor.

- Low Voltage Wiring
- Configuring the CO2 Sensor

8.1 Low Voltage Wiring

AC-2000 Plus Broiler, Version 8.11 supports a CO2 sensor.

1. Connect the CO2 wires to:
 - a COM Port
 - an analog input port (port 13 or 14)
2. In Menu 94, map the CO2 sensor to the analog port to which the sensor is wired (2 or 3).

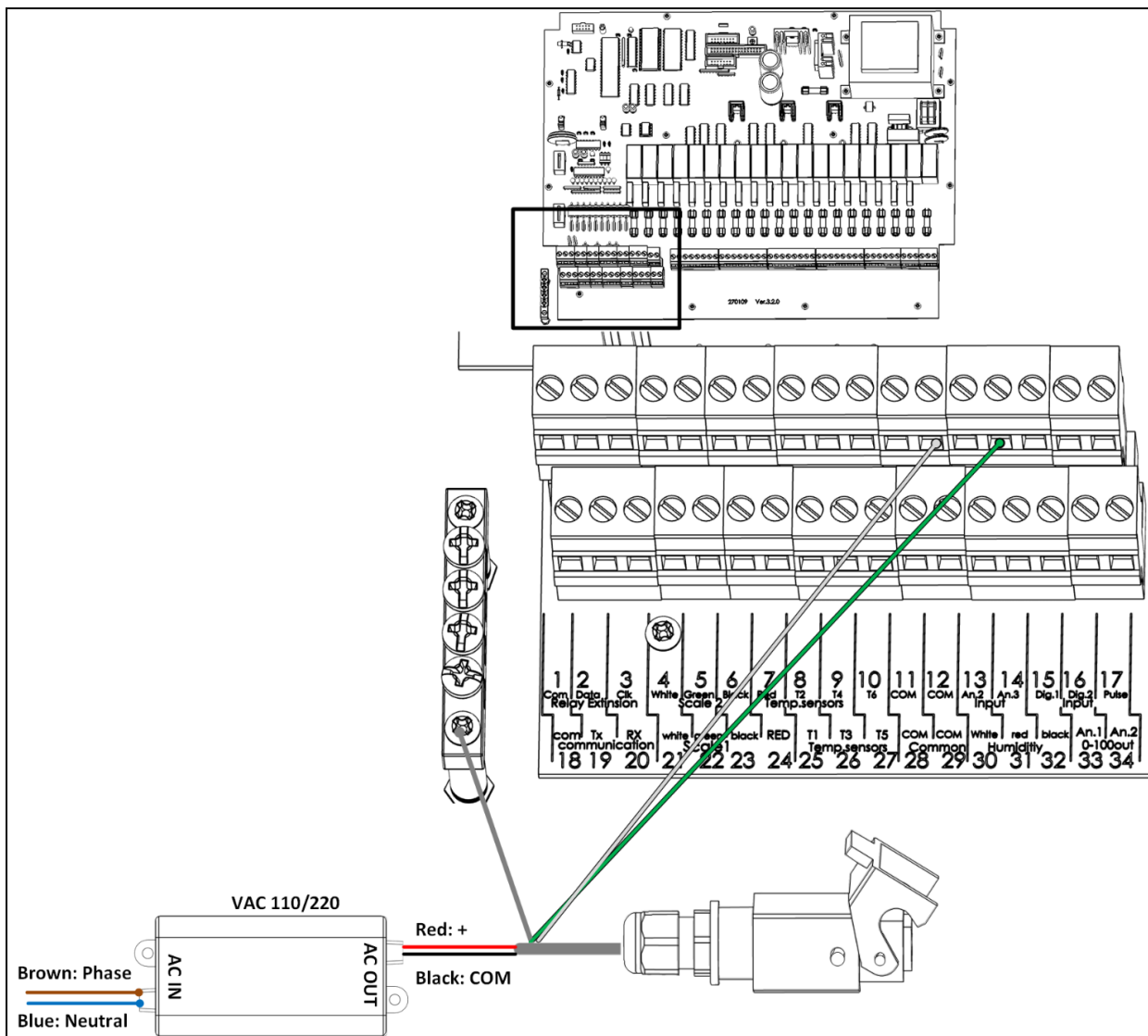

8.2 Configuring the CO2 Sensor

- In the CO2 sensor, verify that the J2 jumper is shorted. Refer to Figure 11.

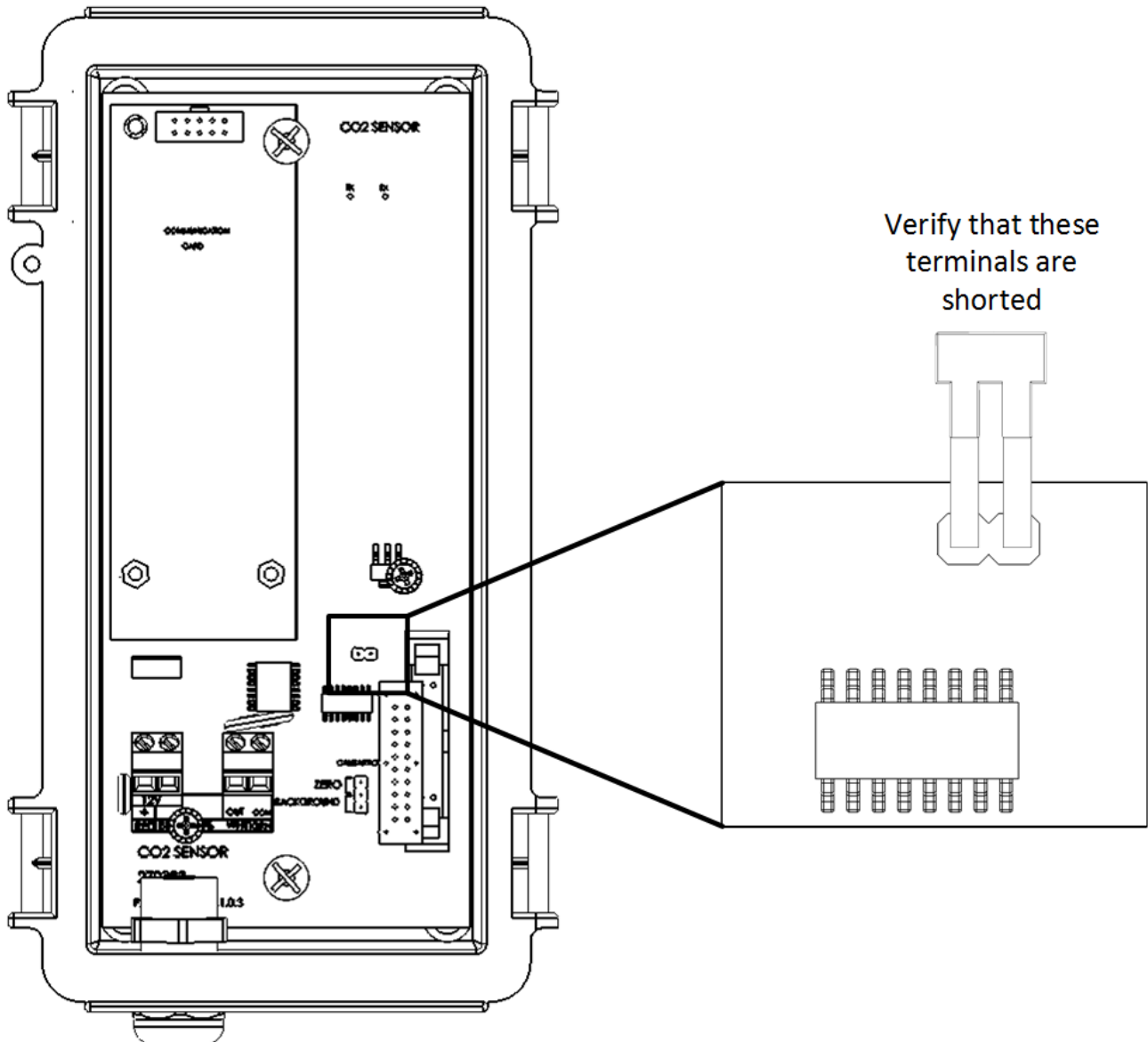

Figure 11: J2 Jumper Shorted

- All other installation instructions are the same. Refer to the CO2 Sensor Manual for details.

9 Warranty

Warranty and technical assistance

Munters products are designed and built to provide reliable and satisfactory performance but cannot be guaranteed free of faults; although they are reliable products they can develop unforeseeable defects and the user must take this into account and arrange adequate emergency or alarm systems if failure to operate could cause damage to the articles for which the Munters plant was required: if this is not done, the user is fully responsible for the damage which they could suffer.

Munters extends this limited warranty to the first purchaser and guarantees its products to be free from defects originating in manufacture or materials for one year from the date of delivery, provided that suitable transport, storage, installation and maintenance terms are complied with. The warranty does not apply if the products have been repaired without express authorisation from Munters, or repaired in such a way that, in Munters' judgement, their performance and reliability have been impaired, or incorrectly installed, or subjected to improper use. The user accepts total responsibility for incorrect use of the products.

The warranty on products from outside suppliers fitted to AC-2000, (for example sensors, cables, thermostats, etc.) is limited to the conditions stated by the supplier: all claims must be made in writing within eight days of the discovery of the defect and within 12 months of the delivery of the defective product. Munters has thirty days from the date of receipt in which to take action, and has the right to examine the product at the customer's premises or at its own plant (carriage cost to be borne by the customer).

Munters at its sole discretion has the option of replacing or repairing, free of charge, products which it considers defective, and will arrange for their despatch back to the customer carriage paid. In the case of faulty parts of small commercial value which are widely available (such as bolts, etc.) for urgent despatch, where the cost of carriage would exceed the value of the parts, Munters may authorise the customer exclusively to purchase the replacement parts locally; Munters will reimburse the value of the product at its cost price.

Munters will not be liable for costs incurred in demounting the defective part, or the time required to travel to site and the associated travel costs. No agent, employee or dealer is authorised to give any further guarantees or to accept any other liability on Munters' behalf in connection with other Munters products, except in writing with the signature of one of the Company's Managers.

WARNING: *In the interests of improving the quality of its products and services, Munters reserves the right at any time and without prior notice to alter the specifications in this manual.*

The liability of the manufacturer Munters ceases in the event of:

- dismantling the safety devices;
- use of unauthorised materials;

- inadequate maintenance;
- use of non-original spare parts and accessories.

Barring specific contractual terms, the following are directly at the user's expense:

- preparing installation sites;
- providing an electricity supply (including the protective equipotential bonding (PE) conductor, in accordance with CEI EN 60204-1, paragraph 8.2), for correctly connecting the equipment to the mains electricity supply;
- providing ancillary services appropriate to the requirements of the plant on the basis of the information supplied with regard to installation;
- tools and consumables required for fitting and installation;
- lubricants necessary for commissioning and maintenance.

It is mandatory to purchase and use only original spare parts or those recommended by the manufacturer.

Dismantling and assembly must be performed by qualified technicians and according to the manufacturer's instructions.

The use of non-original spare parts or incorrect assembly exonerates the manufacturer from all liability.

Requests for technical assistance and spare parts can be made directly to the nearest Munters office. A full list of contact details can be found on the back page of this manual.

Munters Israel

18 HaSivim Street

Petach-Tikva 49517, Israel

Telephone: +972-3-920-6200

Fax: +972-3-924-9834

Support@munters.co.il



www.munters.com

Australia Munters Pty Limited, Phone +61 2 8843 1594, **Brazil** Munters Brasil Industria e Comercio Ltda, Phone +55 41 3317 5050, **Canada** Munters Corporation Lansing, Phone +1 517 676 7070, **China** Munters Air Treatment Equipment (Beijing) Co. Ltd, Phone +86 10 80 481 121, **Denmark** Munters A/S, Phone +45 9862 3311, **India** Munters India, Phone +91 20 3052 2520, **Indonesia** Munters, Phone +62 818 739 235, **Israel** Munters Israel Phone +972-3-920-6200, **Italy** Munters Italy S.p.A., Chiusavecchia, Phone +39 0183 52 11, **Japan** Munters K.K., Phone +81 3 5970 0021, **Korea** Munters Korea Co. Ltd., Phone +82 2 761 8701, **Mexico** Munters Mexico, Phone +52 818 262 54 00, **Singapore** Munters Pte Ltd., Phone +65 744 6828, **South Africa and Sub-Sahara Countries** Munters (Pty) Ltd., Phone +27 11 997 2000, **Spain** Munters Spain S.A., Phone +34 91 640 09 02, **Sweden** Munters AB, Phone +46 8 626 63 00, **Thailand** Munters Co. Ltd., Phone +66 2 642 2670, **Turkey** Munters Form Endüstri Sistemleri A.Ş, Phone +90 322 231 1338, **USA** Munters Corporation Lansing, Phone +1 517 676 7070, **Vietnam** Munters Vietnam, Phone +84 8 3825 6838, **Export & Other countries** Munters Italy S.p.A., Chiusavecchia Phone +39 0183 52 11

© Munters AB, 2018